

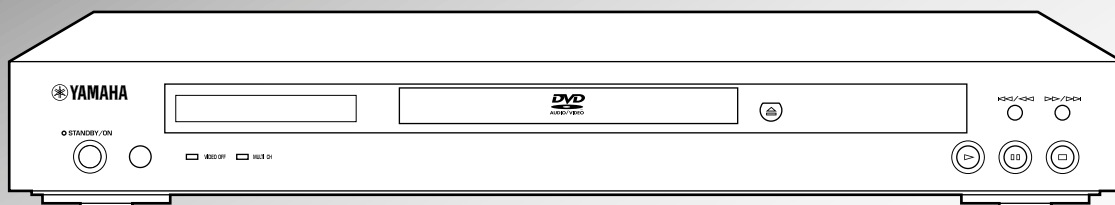

DVD-S830

DVD AUDIO/VIDEO PLAYER
LECTEUR DVD AUDIO/VIDEO



OWNER'S MANUAL
MODE D'EMPLOI
BEDIENUNGSANLEITUNG
BRUKSANVISNING
MANUALE DI ISTRUZIONI
MANUAL DE INSTRUCCIONES
GEBRUIKSAANWIJZING

CAUTION!

THIS PRODUCT UTILIZES A LASER.
USE OF CONTROLS OR ADJUSTMENTS OR
PERFORMANCE OF PROCEDURES OTHER THAN
THOSE SPECIFIED HEREIN MAY RESULT IN
HAZARDOUS RADIATION EXPOSURE.
DO NOT OPEN COVERS AND DO NOT REPAIR
YOURSELF. REFER SERVICING TO QUALIFIED
PERSONNEL.

WARNING:

TO REDUCE THE RISK OF FIRE, ELECTRIC SHOCK OR
PRODUCT DAMAGE, DO NOT EXPOSE THIS
APPARATUS TO RAIN, MOISTURE, DRIPPING OR
SPASHING AND THAT NO OBJECTS FILLED WITH
LIQUIDS, SUCH AS VASES, SHALL BE PLACED ON
THE APPARATUS.

This product may receive radio interference caused by mobile
telephones during use. If such interference is apparent, please
increase separation between the product and the mobile telephone.

DANGER	- VISIBLE AND INVISIBLE LASER RADIATION WHEN OPEN. AVOID DIRECT EXPOSURE TO BEAM. (FDA 21 CFR)
CAUTION	- VISIBLE AND INVISIBLE LASER RADIATION WHEN OPEN. AVOID EXPOSURE TO BEAM. (IEC60825-1)
ATTENTION	- RAYONNEMENT LASER VISIBLE ET INVISIBLE EN CAS D'OUVERTURE. EXPOSITION DANGEREUSE AU FAISCEAU.
ADVARSEL	- SYNLIG OG USYNLIG LASERSTRÅLING VED ÅBNING. UNNGÅ UDSÆTTELSE FOR STRÅLING.
VARO!	- AVATTAESSA OLET ALTTIINA NÄKYVÄÄ JA NÄKYMÄTÖN LASERÄTEILYLLE. ÄLÄ KÄTSÖ SÄTEESEEN.
VARNING	- SYNLIG OCH OSYNLIG LASERSTRÅLNING NÄR DENNA DEL ÄR ÖPPNAD. BETRÄKTA EJ STRÅLEN.
ADVARSEL	- SYNLIG OG USYNLIG LASERSTRÅLING NÄR DEKSEL ÅPNES. UNNGÅ EKSPONERING FOR STRÅLEN.
VORSICHT	- SICHTBARE UND UNSICHTBARE LASERSTRÄHLUNG, WENN ABDECKUNG GEÖFFNET. NICHT DEM STRAHL AUSSETZEN.
注意	- 打开时有可见及不可见激光辐射。避免激光束照射。
注意	- ここを開くと可視及び不可視のレーザー光が出ます。 ビームを直視見たり、触れたりしないでください。 RQLS0233

(Inside of product)
(Intérieur de l'appareil)
(Im Inneren des Gerätes)
(Apparatens insida)
(All'interno dell'unità)
(Parte interior del aparato)
(Binnenin de speler)
(Produktets insidde)
(Tuotteen sisällä)

CAUTION!

- DO NOT INSTALL, OR PLACE THIS UNIT, IN A
BOOKCASE, BUILT-IN CABINET OR IN ANOTHER
CONFINED SPACE. ENSURE THE UNIT IS WELL
VENTILATED. TO PREVENT RISK OF ELECTRIC
SHOCK OR FIRE HAZARD DUE TO OVERHEATING,
ENSURE THAT CURTAINS AND ANY OTHER
MATERIALS DO NOT OBSTRUCT THE VENTILATION
VENTS.
- DO NOT OBSTRUCT THE UNIT'S VENTILATION
OPENINGS WITH NEWSPAPERS, TABLECLOTHS,
CURTAINS, AND SIMILAR ITEMS.
- DO NOT PLACE SOURCES OF NAKED FLAMES,
SUCH AS LIGHTED CANDLES, ON THE UNIT.
- DISPOSE OF BATTERIES IN AN ENVIRONMENTALLY
FRIENDLY MANNER.

THIS UNIT IS INTENDED FOR USE IN MODERATE CLIMATES.

CLASS 1 LASER PRODUCT
LASER KLASSE 1 PRODUKT
LUOKAN 1 LASERLAITE
KLASS 1 LASER APPARAT
PRODUIT LASER DE CLASSE 1

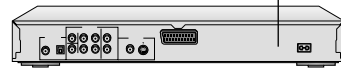

NORSK

ADVARSEL!

DETTE PRODUKTET ANVENDER EN LASER.
BETJENING AV KONTROLLER, JUSTERINGER ELLER
ANDRE INNGREP ENN DE SOM ER BESKREVENT I
DENNE BRUKSANVISNING, KAN FØRE TIL FARLIG
BESTRÅLING.
DEKSLER MÅ IKKE ÅPNES, OG FORSØK ALDRI Å
REPARERE APPARATET PÅ EGENHÅND. ALT
SERVICE OG REPARASJONSARBEID MÅ UTFØRES AV
KVALIFISERT PERSONELL.

ADVARSEL:

FOR Å REDUSERE FAREN FOR BRANN, ELEKTRISK
STØT ELLER SKADER PÅ PRODUKTET, MÅ DETTE
APPARATET IKKE UTSETTES FOR REGN, FUKTIGHET,
VANNDRÅPER ELLER VANNSPRUT. DET MÅ HELLER
IKKE PLASSERES GJENSTANDER FYLT MED VANN,
SLIK SOM BLOMSTERVASER, OPPÅ APPARATET.

ADVARSEL!

- APPARATET MÅ IKKE PLASSERES I EN BOKHYLLE,
ET INNEBYGGET KABINETT ELLER ET ANNET
LUKKET STED HVOR VENTILASJONSFORHOLDENE
ER UTILSTREKkelige. SØRG FOR AT GARDINER
ELLER LIGNENDE IKKE FORVERRER
VENTILASJONSFORHOLDENE, SÅ RISIKO FOR
ELEKTRISK SJOKK ELLER BRANN FORÅRSAKET AV
OVERHETING UNNGÅS.
- APPARATETS VENTILASJONSÅPNINGER MÅ IKKE
DEKKES TIL MED AVISER, BORDDUKER, GARDINER
OG LIGNENDE.
- PLASSER IKKE ÅPEN ILD, SLIK SOM LEVENDE LYS,
OPPÅ APPARATET.
- BRUKTE BATTERIER MÅ KASSERES UTEN FARE
FOR MILJØET.

DETTE APPARATET ER BEREGNET TIL BRUK UNDER
MODERATE KLIMAFORHOLD.

SUOMI

VAROITUS!

LAITTEEN KÄYTTÄMINEN MUULLA KUIN TÄSSÄ
KÄYTTÖOHJEESSA MAINITULLA TAVALLA SAATTA
ALTISTAA KÄYTTÄJÄN TURVALLISUUSLUOKAN 1
YLITTÄVÄLLE NÄKYMÄTTÖMÄLLE LASERÄTEILYLLE.

VAROITUS:

TULIPALO-, SÄHKÖISKUAARAN TAI TUOTETTA
KOHITTAAVAN MUUN VAHINGON VÄHENTÄMISEKSI EI
LAITETTA SAA ALTISTAA SATEELLE, KOSTEUEDELLE,
VESIPISAROILLE TAI ROISKEELLE, EIKÄ NESTETTÄ
SISÄLTÄVIÄ ESINEITÄ, KUTEN ESIMERKIKSI
MALJAKOITA, SAA ASETTAA LAITTEEN PÄÄLLE.

VAROITUS!

- ÄLÄ ASENNATA LAITTA TÄTÄ LAITETTA
KABINETTITYYPPISEEN KIRJAKAAPPIIN TAI
MUUHUN SULJETTUUN TILAAN, JOTTA TUULETUS
ONNISTUISI. VARMISTA, ETTÄ VERHO TAI MIKÄÄN
MUU MATERIAALI EI HUONONNA TUULETUSTA,
JOTTA VÄLTETTÄISIIN YLIKUUMENEMISESTA
JOHTUVA SÄHKÖISKU- TAI TULIPALOVAARA.
- ÄLÄ PEITÄ LAITTEEN TUULETUSAUKKOJA
SANOMALEHDELLÄ, PÖYTÄLIINALLA, VERHOLLA
TAI MUULLA VASTAAVALLA ESINEELLÄ.
- ÄLÄ ASETA PALAVAA KYNTTILÄÄ TAI MUUTA
AVOTULEN LÄHDETTÄ LAITTEEN PÄÄLLE.
- HÄVITÄ PARISTOT LUONTOA
VAHINGOITTAMATTOMALLA TAVALLA.

TÄMÄ LAITE ON TARKOITETTU KÄYTETTÄVÄKSI LEUDOSSA
ILMASTOSSA.

CAUTION: READ THIS BEFORE OPERATING YOUR UNIT.

- 1 To assure the finest performance, please read this manual carefully. Keep it in a safe place for future reference.
- 2 Install this sound system in a well ventilated, cool, dry, clean place — away from direct sunlight, heat sources, vibration, dust, moisture, or cold. In a cabinet, allow about 2.5cm (1 inch) of free space all around this unit for adequate ventilation.
- 3 Locate this unit away from other electrical appliances, motors, or transformers to avoid humming sounds.
- 4 Do not expose this unit to sudden temperature changes from cold to hot, nor locate this unit in an environment with high humidity (i.e., a room with a humidifier) to prevent condensation inside this unit, which may cause an electrical shock, fire, damage to this unit, and/or personal injury.
- 5 Avoid installing this unit in a location where foreign objects may fall onto this unit or where this unit may be exposed to liquid dripping or splashing. On the top of this unit, do not place:
 - Other components, as they may cause damage and/or discoloration on the surface of this unit.
 - Burning objects (i.e., candles), as they may cause fire, damage to this unit, and/or personal injury.
 - Containers with liquid in them, as they may fall, spilling the liquid and causing an electrical shock to the user and/or damage to this unit.
- 6 Do not cover this unit with a newspaper, tablecloth, curtain, etc. in order not to obstruct heat radiation. If the temperature inside this unit rises, it may cause fire, damage to this unit, and/or personal injury.
- 7 Do not plug in this unit to a wall outlet until all connections are complete.
- 8 Do not operate this unit upside-down. It may overheat, possibly causing damage.
- 9 Do not use excessive force on switches, knobs and/or cords.
- 10 When disconnecting the power cord from the wall outlet, grasp the plug; do not pull the cord.
- 11 Do not clean this unit with chemical solvents; this might damage the finish. Use a clean, dry cloth.
- 12 Use only the voltage specified on this unit. Using this unit with a higher voltage than specified is dangerous and may cause fire, damage to this unit, and/or personal injury. YAMAHA will not be held responsible for any damage resulting from use of this unit with a voltage other than as specified.
- 13 To prevent damage by lightning, disconnect the power cord from the wall outlet during an electrical storm.
- 14 Do not attempt to modify or fix this unit. Contact qualified YAMAHA service personnel when any service is needed. The cabinet should never be opened for any reason.
- 15 When not planning to use this unit for long periods of time (i.e., vacation), disconnect the AC power plug from the wall outlet.
- 16 Be sure to read the "Troubleshooting guide" section on common operating errors before concluding that this unit is faulty.
- 17 Before moving this unit, press STANDBY/ON to set the unit in standby mode, then disconnect the AC power plug from the wall outlet.

The unit is not disconnected from the AC power source as long as it is connected to the wall outlet, even if this unit itself is turned off. This state is called the standby mode. In this state, this unit is designed to consume a very small quantity of power.

NOTE

Pictures shown maybe different between countries.
Never make or change connections with the power switched on.

When playing DTS encoded CDs, excessive noise will be heard from the analog stereo outputs. To avoid possible damage to the audio system, the consumer should take proper precautions when the analog stereo outputs of the player are connected to an amplification system.

Dear customer

Thank you for purchasing this product. For optimum performance and safety, please read these instructions carefully.

Table of contents

Getting started

Accessories	4
Disc information	4
Control reference guide	5
Connection	6
Audio connection	6
Video connection	7
Connecting the power cable	7
The remote control	8
Quick Setup	8

Basic operations

Basic play	9
When a menu screen appears on the television	9
Resume function	9
Starting play from a selected item	10
Skipping items	10
Fast forward and rewind—SEARCH	10
Slow-motion play	10
Frame-by-frame viewing	10
Using menus to play MP3 discs and CD text	11

Advanced operations

Increasing your enjoyment of movies	12
Cinema	12
Dialogue Enhancer	12
Advanced Surround	12
Changing soundtracks, subtitles and angles	13
4:3 TV Zoom function	13
Convenient features	14
Selecting groups to play	14
Selecting still pictures—Page Skip	14
To enjoy even higher quality sound—VIDEO OFF	14
A-B repeat play	14
Repeat play	15
Random play	15
Program play/All group play	15
Using Graphical User Interface (GUI) screens	16
Common procedures	16
Disc information	16
Unit information	17
Changing settings	18
Common procedures	19
Entering a password (Ratings)	19
Digital output	19
Speaker setting	20

Reference

Troubleshooting guide	21
Glossary	22
Specifications	23

Accessories

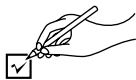

Please check and identify the supplied accessories.

Note

The included power cable is for use with this unit only. Do not use it with other equipment.

- 1 Remote control



- 2 Batteries for remote control

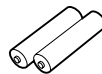

- 1 Audio/video cable



- 1 Power cable



Disc information

Discs that can be played

Disc type	Logo	Indication in these operating instructions
DVD-Audio		DVD-A
DVD-Video		
DVD+RW/+R*1		DVD-V
DVD-R/RW*1, *2		
Video CD		VCD
CD		CD
CD-R/RW*1		VCD CD MP3

*1 Some discs cannot be played depending on the disc characteristics or recording conditions.

*2 This unit can play DVD-R/RW if they are recorded with the Video Format.

Do not use irregularly shaped discs (e.g. heart-shaped), as these can damage the unit.

Region number supported by this player

Region numbers are allocated to DVD players and software according to where they are sold.

- The region number of this player is "2".
- The player will play DVD-Video marked with labels containing "2" or "ALL".

Example:



Discs that cannot be played

DVD-ROM, DVD-RAM, CD-ROM, CDV, CD-G, CVD, SVCD, SACD, Divx Video Discs, Photo CD, etc.

DVDs that can be played

You can play discs with these symbols.



Playing DVDs and Video CDs

The producer of these discs can control how they are played so you may not always be able to control play as described in these operating instructions. Read the disc's instructions carefully.

Video systems

- This unit can play PAL and NTSC, but your television must match the system used on the disc.
- PAL discs cannot be correctly viewed on an NTSC television.
- This unit can convert NTSC signals to PAL 60 for viewing on a PAL television (→ page 18, Video—NTSC Disc Output).

CD-R and CD-RW discs

This unit can play CD-R and CD-RW if they are formatted as CD-DA (digital audio) or video CD and finalized*3.

DVD-R/RW and DVD+RW/+R discs

Discs recorded and finalized*3 on a DVD video recorder.

*3 A process that allows play on compatible equipment.

To clean discs

Wipe with a damp cloth and then wipe dry.



Handling precautions

- Do not write on the label side with a ball-point pen or other writing instrument.
- Do not use record cleaning sprays, benzine, thinner, static electricity prevention liquids or any other solvent.
- Do not attach labels or stickers to discs. (Do not use discs with exposed adhesive from tape or left over peeled-off stickers.)
- Do not use scratch-proof protectors or covers.
- Do not use discs printed with label printers available on the market.

Operations in these instructions are described mainly with the remote control, but you can do the operations on the main unit if the controls are the same.

Page

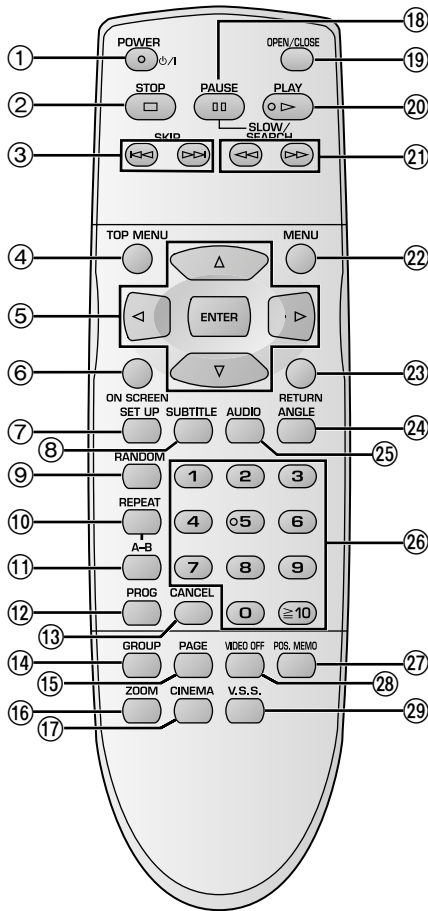

① Standby/on button (POWER ⏻/I)	8
② Stop button (■ STOP)	9
③ Skip buttons (⏮, ⏭) SKIP	10
④ Top menu button (TOP MENU)	9
⑤ Cursor buttons (▲, ▼, ◀, ▶), Enter button (ENTER)	8
⑥ On screen button (ON SCREEN)	16
⑦ Setup button (SET UP)	8, 19
⑧ Subtitle button (SUBTITLE)	13
⑨ Random button (RANDOM)	15
⑩ Repeat button (REPEAT)	15
⑪ A-B repeat button (A-B)	14
⑫ Program button (PROG)	15
⑬ Cancel button (CANCEL)	15
⑭ Group button (GROUP)	14
⑮ Page button (PAGE)	14
⑯ 4:3 TV zoom button (ZOOM)	13
⑰ Cinema button (CINEMA)	12
⑱ Pause button (⏸ PAUSE)	9
⑲ Open/Close button (▲, OPEN/CLOSE)	9
⑳ Play button (▶ PLAY)	9
㉑ Slow/Search buttons (⏮, ⏭) SLOW/SEARCH	10
㉒ Menu button (MENU)	9
㉓ Return button (RETURN)	8
㉔ Angle button (ANGLE)	13
㉕ Audio button (AUDIO)	13
㉖ Numbered buttons (1-9, 0, ≥10)	10
㉗ Position memory button (POS. MEMO)	9
㉘ Video off button (VIDEO OFF)	14
㉙ Advanced Surround button (V.S.S.)	12
㉚ Standby/on switch (STANDBY/ON)	
Press to switch the unit from on to standby mode or vice versa. In standby mode, the unit is still consuming a small amount of power.	
㉛ Display	
㉜ Disc tray	9
㉝ Skip/Slow/Search buttons (⏮/◀, ▶/⏭)	10
㉞ Standby indicator	
When the unit is connected to the AC mains supply, this indicator lights up in standby mode and goes out when the unit is turned on.	
㉟ Remote control signal sensor	
㊱ Video off indicator (VIDEO OFF)	14
㊲ Multi-channel indicator (MULTI CH)	13

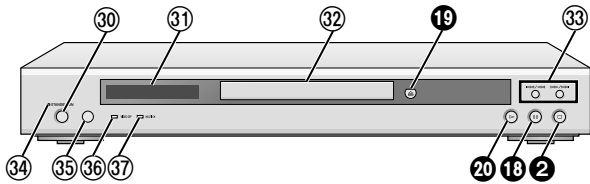

Buttons such as ② function the same as the controls on the remote control.

Audio connection

Note

- The equipment connections described are examples.
- Peripheral equipment and optional cables sold separately unless otherwise indicated.
- Before connection, turn off all equipment and read the appropriate operating instructions.

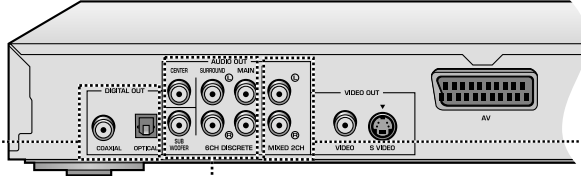

A Digital connection

Connect an amplifier with Dolby Digital and DTS decoders. You can also enjoy high-quality stereo sound with sampling frequencies of 88.2 and 96 kHz if the material isn't copy-protected and the equipment you connect is compatible with these signals.

Change "Digital output" (⇒ page 19).

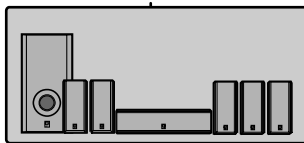
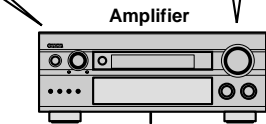
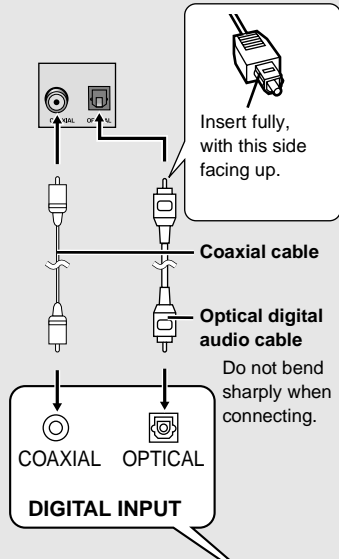

Speakers (example)

B Analogue (6CH DISCRETE) connection

Connect an amplifier with multi-channel audio input terminals to enjoy surround sound. This unit can decode Dolby Digital and DTS and there are no limitations on sampling frequency with this kind of connection.

To obtain maximum performance of DVD-Audio multi-channel linear PCM sound, the connections are recommended.

Change "Speaker setting" (⇒ page 20).

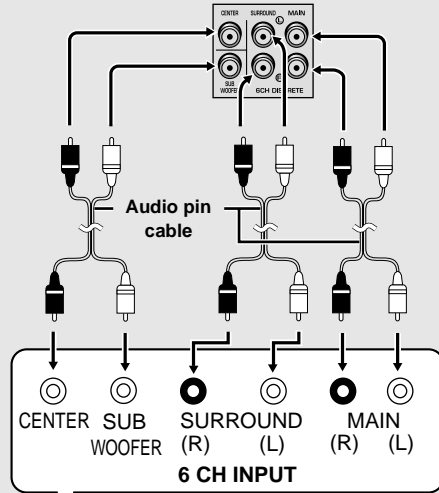

C Analogue (MIXED 2CH) connection

Connect these jacks to the AUDIO L and R input jacks of your amplifier using the supplied Audio/Video cable.

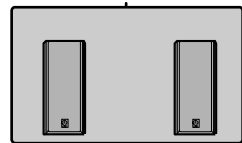
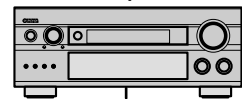
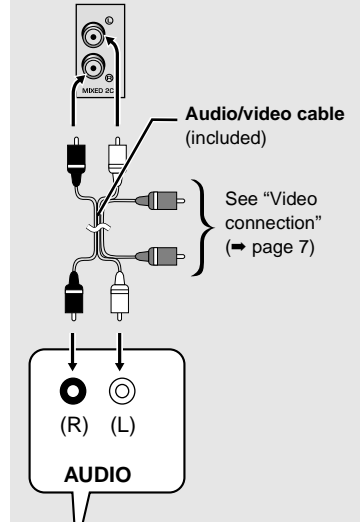

Speakers (example)

Video connection

This unit equips three types of video jacks as follows:

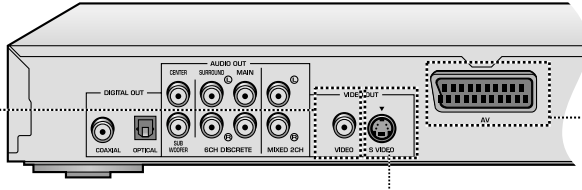

D VIDEO jack

This jack transmits conventional composite video signal. Connect this jack to your AV amplifier so that you can switch the both audio and video inputs at once.

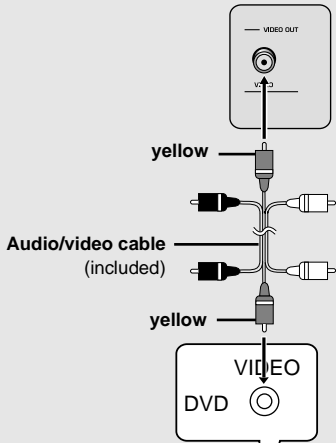

E S VIDEO jack

This jack transmits color and luminance separately and achieves high quality color reproduction. Connect this jack to your television using a commercially available S-Video cable. If your AV amplifier is equipped with S VIDEO input and output jacks, connect to the AV amplifier so that you can switch both audio and video inputs at once.

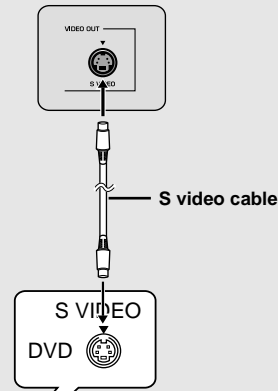

F AV (SCART) jack

This SCART jack can output RGB component signals and provides the best quality picture. Connect this jack to your television.

- Change "Video—AV Output" (→ page 18)

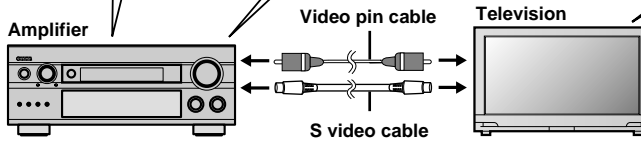
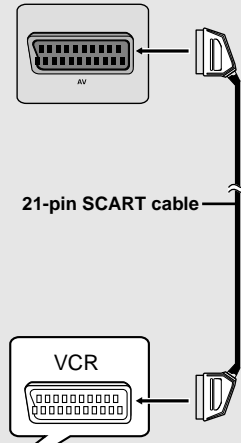

Note

Do not connect this unit to a television through a video cassette recorder. If you do so, the picture may not be played back properly due to the copyright protection technology incorporated in this unit.

Connecting the power cable

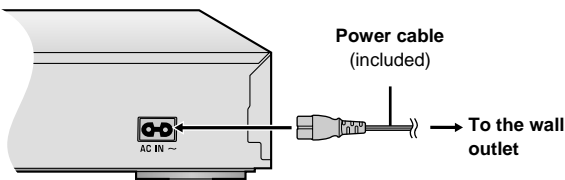

Plug the power cable into the AC IN when all connections are complete, and then plug this unit to the wall outlet.

Caution

Do not use other AC power cables than the one provided. Otherwise it may result in causing fire or an electrical shock.

The remote control

Batteries

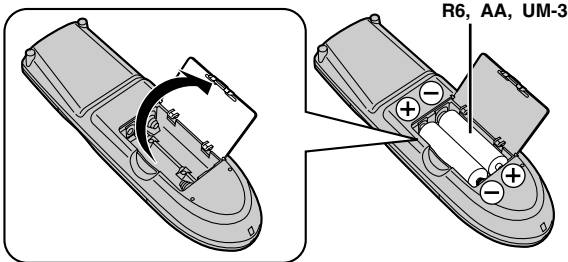

- Insert so the poles (+ and -) match those in the remote control.
- Do not use rechargeable type batteries.

Do not:

- mix old and new batteries.
 - use different types at the same time.
 - heat or expose to flame.
 - take apart or short circuit.
 - attempt to recharge alkaline or manganese batteries.
 - use batteries if the covering has been peeled off.
- Mishandling of batteries can cause electrolyte leakage which can damage items the fluid contacts and may cause a fire.

Remove if the remote control is not going to be used for a long period of time. Store in a cool, dark place.

Use

Aim at the sensor (➡ page 5, Control reference guide), avoiding obstacles, at a maximum range of 7 m directly in front of the unit.

Quick Setup

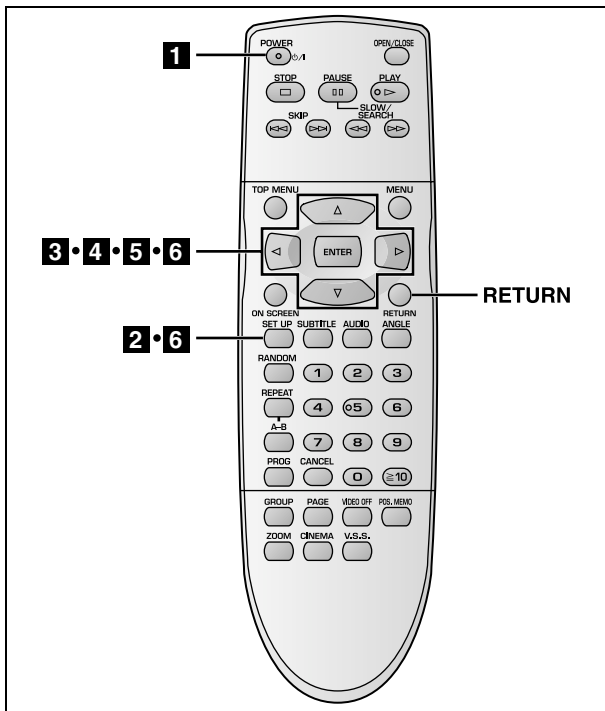

3 Press [**▲**, **▼**, **◀**, **▶**] to select the menu language and press [**ENTER**].

4 Press [**▲**, **▼**] to select “Yes” to continue and press [**ENTER**].

5 Press [**▲**, **▼**, **◀**, **▶**] to select the item and press [**ENTER**].

- Audio Language (➡ page 18)
- Subtitle Language (➡ page 18)
- TV Aspect (➡ below)
- Speaker Setting (➡ page 18)

6 Press [**ENTER**] and then [**SET UP**] to end the settings.

To return to the previous screen

Press [**RETURN**].

TV Aspect

Select “4:3” (regular) or “16:9” (widescreen) to suit your television. If you have a regular 4:3 television, you can also select how video on some discs is shown (➡ page 18, Video—TV Aspect).

•4:3 Pan&Scan (Factory preset)

Widescreen software is expanded to fill the screen of a 4:3 aspect television (unless prohibited by the producer of the disc).



•4:3 Letterbox

Widescreen software is shown in the letterbox style on a 4:3 aspect television.



The **QUICK SETUP** screen appears when you press [**SET UP**] the first time after purchase and assists you to make necessary settings. You can access this screen again later if you need to (➡ page 18, Others—QUICK SETUP).

Preparation

Turn on the other equipment (amplifier, television, etc.) and select the audio/video input to suit the connections to this player.

1 Press [**POWER** **⏻**] to turn on the unit.

2 Press [**SET UP**] to show the **QUICK SETUP** screen.

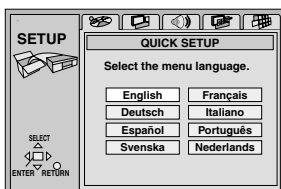

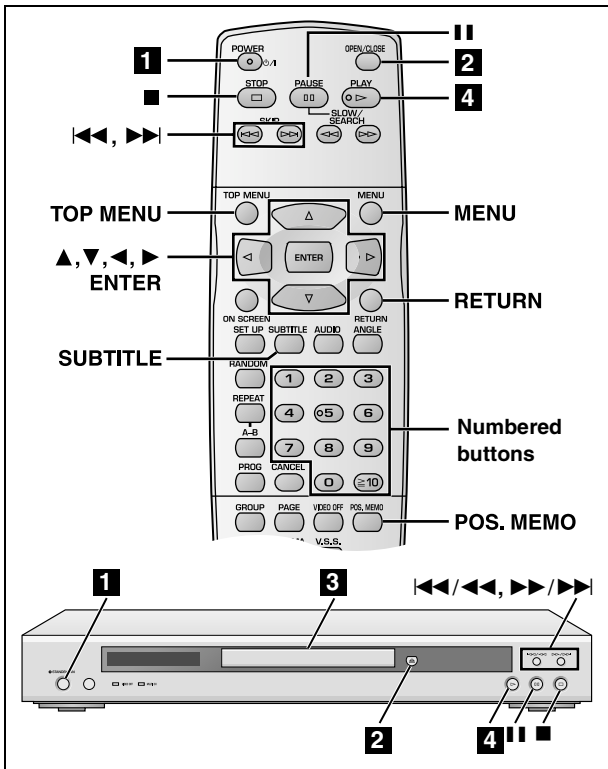

DVD-A DVD-V VCD CD MP3

Preparation

Turn on the other equipment (amplifier, television, etc.) and select the audio/video input to suit the connections to this player.

- 1** Press [POWER] to turn on the unit.
- 2** Press [OPEN/CLOSE] to open the disc tray.
- 3** Place the disc on the disc tray.
Label-up (With double-sided discs, load so the label for the side you want to play is facing up.)
- 4** Press [▶] (PLAY).

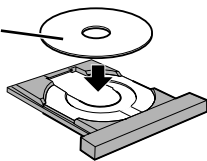

The disc tray closes and play begins.

Group and track names (MP3) or title and artist names (CD-text) are displayed on the television. Press [SUBTITLE] to turn the display on or off.

To stop play

Press [■] (⇒ right, Resume function).

To pause play

Press [⏸].

Press [▶] (PLAY) to restart play.

Auto standby

The unit switches to standby mode after about 30 minutes in the stop mode.

Note

• If "⏸" appears on the television

The operation is prohibited by the unit or disc.

• Discs continue to rotate while menus are displayed even after playing an item. Press [■] when you finish to preserve the unit's motor and your television screen.

• Volume may be lower when playing DVDs than when playing other discs or during television broadcasts. Reduce the volume before playing other sources so that a sudden increase in output does not occur.

When a menu screen appears on the television

DVD-A DVD-V VCD

Press the numbered buttons to select an item.

To select a 2-digit number

e.g. 23: [≥10] ⇒ [2] ⇒ [3]

• When playing DVDs, you can also use [▲, ▼, ◀, ▶] to select items. Press [ENTER] to confirm your selection.

Play of the selected item now begins.

Other buttons used to operate menus

Read the disc's instructions for further details about operation.

[▶], [▶/▶]: Shows the next menu.

[◀], [◀/◀]: Shows the previous menu. VCD

[RETURN]: Shows the menu screen.

[TOP MENU]: Shows the first menu screen. DVD-A DVD-V

[MENU]: Shows the menu screen. DVD-V

Resume function

DVD-A DVD-V VCD CD MP3

(When the elapsed play time is displayed)

The position you stopped play at is recorded by the unit when "▷" is flashing on the display.



While "▷" is flashing, press [▶] (PLAY) to start play from where you stopped it. (When playing DVD-Video ⇒ Chapter Review below)

• The position is cleared when the disc tray is opened or the unit is switched to standby.

To clear the position

Press [■] before recalling the memorized position.

Position Memory function

This function allows you to memorize a position to start from even after switching the unit to standby or changing discs. You can memorize positions on up to five different discs at a time. When you memorize another position, the earliest position is replaced.

• This function does not work while playing some DVDs.

1. During play, press [POS. MEMO].

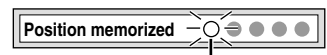

Light as you memorize positions.

2. Press [POWER] to switch the unit to standby, or press [OPEN/CLOSE] to remove the disc.
3. When you are ready to play the disc again, press [▶] (PLAY). Play starts from the memorized position and the position is cleared. (When playing DVD-Video ⇒ Chapter Review below)

To clear the position

Press [■] before recalling the memorized position.

Chapter Review DVD-V

The following message appears immediately after you press [▶] (PLAY).

Press [▶] (PLAY) while the message is displayed and the beginning portions of each chapter up to the current one are played. Full play resumes from the point where you pressed [■] or [POS. MEMO]. (This feature works only within a title.)

If you do not press [▶] (PLAY), the message disappears and play starts from where you pressed [■] or [POS. MEMO].

Press PLAY to Chapter Review

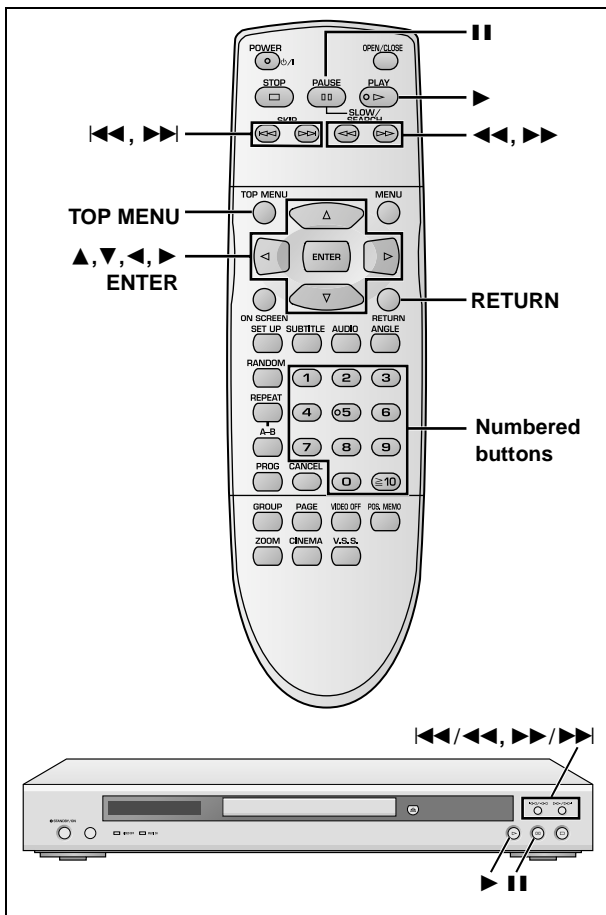

Starting play from a selected item

DVD-A DVD-V VCD CD MP3

Press the numbered buttons to select the item.

To select a 2-digit number
e.g. 23: [≧10] → [2] → [3]

MP3

Press [ENTER] after pressing the numbered buttons. (You do not have to press [≧10].)

Play starts from the selected item.

Note

- This works only when stopped with some discs.
- When playing DVD-Audio and you want to start play from a track in a different group, select the group first (→ page 14).

Skipping items

DVD-A DVD-V VCD CD MP3

You can skip chapters on DVD-Video, tracks on DVD-Audio, Video CDs, CDs, and MP3 discs.

During play or while paused

Press [≪≪] or [≫≫].

- Press [≪≪/≪≪] or [≫≫/≫≫] on the main unit.
- Each press increases the number of skips.

Fast forward and rewind—SEARCH

DVD-A DVD-V VCD CD MP3

During play

Press [≪≪] or [≫≫].

- Press and hold [≪≪/≪≪] or [≫≫/≫≫] on the main unit.
- You may erase sound during search (→ page 18, Audio—Audio during Search).

Slow-motion play

DVD-A DVD-V VCD

While paused

Press [≪≪] or [≫≫].

Press and hold [≪≪/≪≪] or [≫≫/≫≫] on the main unit.

Frame-by-frame viewing

DVD-A DVD-V VCD

While paused

Press [◀] or [▶].

The frame changes each time you press the button.

- The frames change in succession if you press and hold the button.
- Pressing [⏏] also activates forward frame-by-frame.

Notes

- The speed of search and slow-motion increases up to 5 steps.
- Press [▶] (PLAY) to restart play.
- You cannot move backwards with Video CD during slow-motion and frame-by-frame.
- Slow-motion and frame-by-frame only work on the moving picture parts of DVD-Audio.
- **When playing Video CDs with playback control**
Pressing buttons to perform skip, search or slow-motion may take you to a menu screen.

Using menus to play MP3 discs and CD text

MP3

This unit can play MP3 files recorded on CD-R/RW with a computer. Files are treated as tracks and folders are treated as groups.

CD (CD text)

This unit reads and displays the information on CD text discs. You can display disc titles, artist names and track titles.

1 Press [TOP MENU].

2 Press [▲, ▼] to select the track and press [ENTER].

Play continues to the last track in the last group.
"☞" indicates the track currently playing.

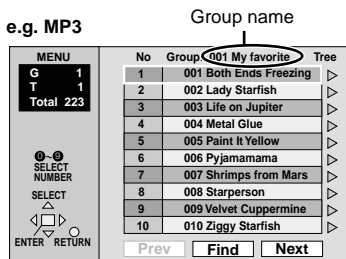

To show other pages

Press [▲, ▼, ◀, ▶] to select "Prev" or "Next" and press [ENTER].

After listing all the tracks in one group, the list for the next group appears.

To exit the file list

Press [TOP MENU].

Using the tree screen to find a group

1 Press [▶] while a track is highlighted to display the tree screen.

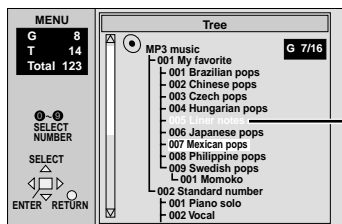

You cannot select groups that contain no compatible files.

2 Press [▲, ▼] to select a group and press [ENTER].

The file list for the group appears.

For your reference

Press [◀, ▶] to jump layers in the tree screen.

To return to the file list

Press [RETURN].

To show the text information for a track

1 Press [▲, ▼] to select a track.

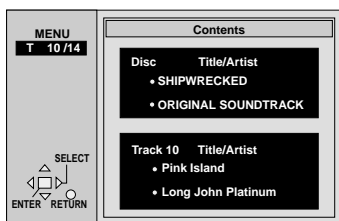

2 Press [▶] to show the text information.

- Press [◀, ▶] to select other tracks. Press [ENTER] to play tracks selected here.

To return to the list screen

Press [RETURN].

Finding a track to play

Enter part of a track title to make a search. Although the characters are upper case, the unit also searches for lower case.

Example: search for tracks including the word "LOVE".

1 Press [▲, ▼] to select "Find" and press [ENTER].

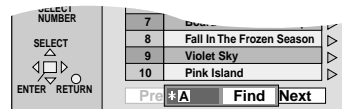

2 Press [▲, ▼] to select "L" and press [ENTER].

Characters change in alphanumeric order each time you press [▲].

- Press [◀◀, ▶▶] to skip between A, E, I, O and U.
- Press [◀] to erase a character.
- Repeat this step to enter "O", "V", and "E".

3 Press [▶] to select "Find" and press [ENTER].

The search results screen appears.

4 Press [▲, ▼] to select the track and press [ENTER].

Press [▼] to show other tracks if there are more than fifteen.

- To search for the first word in a title, erase the asterisk (*) first.
- You can also enter numbers with the numbered buttons.

To return to the list screen

Press [RETURN].

Note

- Discs must conform to ISO9660 level 1 or 2 (except for extended formats).
- This unit is compatible with multi-session but if there are a lot of sessions it takes more time for play to start. Keep the number of sessions to a minimum to avoid this.

MP3

- MP3 files must have the extension ".MP3" or ".mp3".
- This unit is not compatible with ID3 tags.
- This unit is not compatible with files with a sampling rate of 32 kHz.
- If you play a MP3 track that includes still picture data, it will take some time before the music itself starts playing and the elapsed time will not be displayed during this time. Even after the track starts, the correct play time will not be displayed.

Naming folders and files

At the time of recording, prefix folder and file names with 3-digit numbers in the order you want to play them (this may not work at times).

CD (CD text)

When making your own CD text discs

The unit plays the tracks in the order you record them so you do not have to prefix the titles with numbers.

e.g. MP3
root

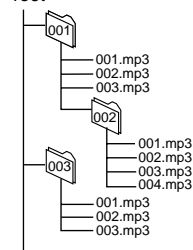

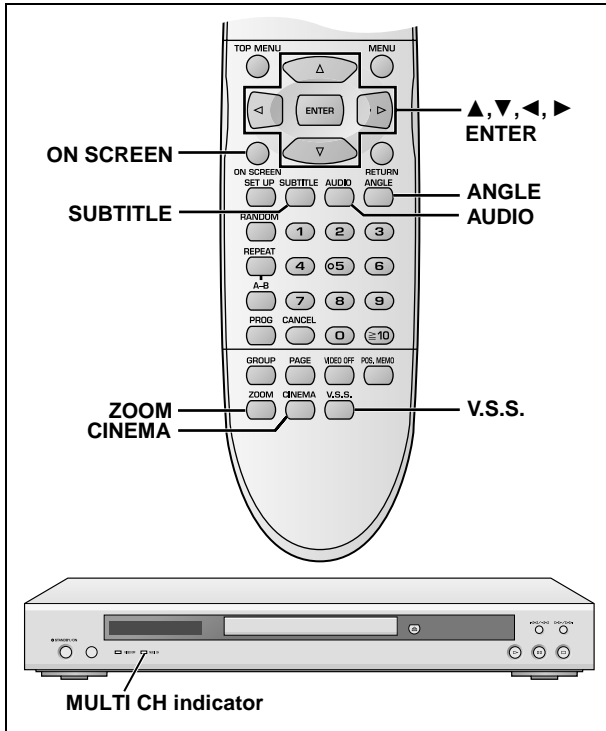

Advanced Surround

DVD-V **VCD**

SP: (Dolby Digital, DTS, LPCM, MPEG, 2-channel or over only)
HP: (Dolby Digital, LPCM, MPEG, 2-channel or over only)

Use Advanced Surround V.S.S. (Virtual Surround Sound) to enjoy a surround-like effect if you are using 2 front speakers (SP) or headphones (HP). (To enjoy HP-V.S.S., connect the unit to equipment that has a headphone jack.)

If you are playing a disc with surround effects recorded on it, the effect is broadened and sound seems to come from virtual speakers on either side.

Press [V.S.S.].

Each time you press the button:

- ↓ **SP1/HP1**: Natural effect
- ↓ **SP2/HP2**: Emphasized effect
- ↓ **SP OFF/HP OFF**: Cancel (Factory preset)



To change the mode: [◀] → [▲, ▼] to select "SP" or "HP"



Optimum seating position

<When using the television's speakers>

Distance A = Television's width

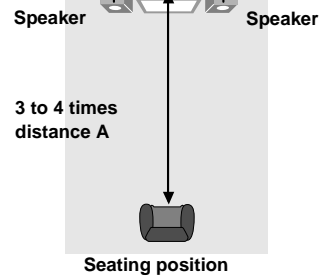

Cinema

DVD-A **DVD-V** **VCD**

You can change the picture quality for movie viewing.

Press [CINEMA].

Each time you press the button:

- ↓ **Cinema1**: Mellows images and enhances detail in dark scenes.
- ↓ **Cinema2**: Sharpens images and enhances detail in dark scenes.
- ↓ **Normal**: Normal mode (Factory preset)



For your reference

You can make finer adjustments to the picture if desired (→ page 17, Picture Menu).

Dialogue Enhancer

DVD-V

(Dolby Digital, DTS, 3-channel or over, where the dialogue is recorded in the center channel)

This makes the dialogue in movies easier to hear.

1. Press [ON SCREEN] to display Unit information.



2. While the leftmost icon is highlighted, press [▲, ▼] to select Audio Menu.



3. Press [◀, ▶] to select Dialogue Enhancer.

Dialogue Enhancer

4. Press [▲, ▼] to select ON or OFF (Factory preset).



Note

- Advanced Surround will not work, or will have less effect with some discs.
- Turn off the surround sound effects on the equipment you have connected when using this effect.
- Turn Advanced Surround off if it causes distortion.
- Even if three or more speakers are connected, output from this unit will be in stereo (two channels) when Advanced Surround is on.
- Turn Advanced Surround off when using Dolby Pro Logic. Dolby Pro Logic will not work correctly if it is on.

Note

Dialogue Enhancer will not work or will have less effect with some discs.

Changing soundtracks, subtitles and angles

Some DVDs have multiple soundtracks, subtitle languages and camera angles, and you can change them during play.

- “-” or “-” is displayed instead of the language number in circumstances such as when no language is recorded on the disc.
- Some discs allow changes to soundtracks, subtitle languages and angles only by using the disc’s menus.

Soundtracks

DVD-A DVD-V VCD

During play
Press [AUDIO].

The setting changes each time you press the button.

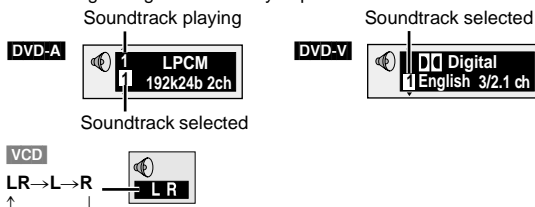

- The MULTI CH indicator on the main unit lights when a multi-channel soundtrack is playing.
- Indicates that a multi-channel soundtrack can be down-mixed to two channels.
e.g. DVD-Video



- Play restarts from the beginning of the soundtrack when playing DVD-Audio soundtracks that are accompanied by still pictures.
- Even if a second soundtrack isn't recorded on a DVD-Audio, two soundtrack numbers will normally be shown when you press [AUDIO]. The soundtrack currently playing is number 1.
- You can also use this button to turn the vocals on and off on karaoke discs. Read the disc's instructions for details.
- Refer to **B** below for audio signal type details.

A Audio/Subtitle language

ENG: English	POR: Portuguese
FRA: French	RUS: Russian
DEU: German	JPN: Japanese
ITA: Italian	CHI: Chinese
ESP: Spanish	KOR: Korean
NLD: Dutch	MAL: Malay
SVE: Swedish	VIE: Vietnamese
NOR: Norwegian	THA: Thai
DAN: Danish	*: Others

B Signal type/data

LPCM/PPCM/□□ Digital/DTS/MPEG: Signal type

k (kHz): Sampling frequency

b (bit): Number of bits

ch (channel): Number of channels

Example: 3/2_1ch

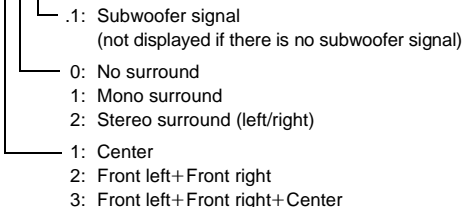

Subtitles

DVD-A DVD-V

You can change the subtitle language and turn the subtitles on and off.

During play
Press [SUBTITLE].

The number changes each time you press the button.

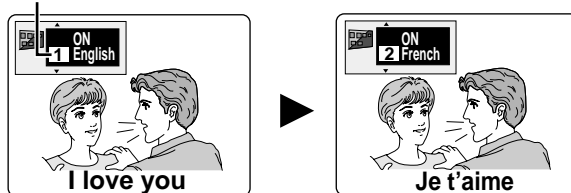

- In some cases, the subtitle language is not changed to the selected one immediately.

To clear/display the subtitles

1. Press [SUBTITLE].
2. Press [▶].
3. Press [▲, ▼] to select “OFF” or “ON”.

Angles

DVD-A DVD-V

During play
Press [ANGLE].

The number changes each time you press the button.

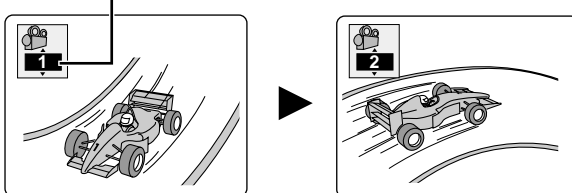

4:3 TV Zoom function

DVD-A DVD-V

Widescreen software often appears as a letterbox picture (→ page 8) when shown on a regular 4:3 aspect television. Use 4:3 TV Zoom to expand these pictures to fill more of the television. (The sides of the picture are cut off when you do this.)

During play
Press [ZOOM].



Each time you press the button:

ON ← → OFF (Factory preset)

- 4:3 TV Zoom is canceled when the disc tray is opened or the unit is switched to standby.

Note

- Depending on the video format of the disc and current play status, this feature may not work as described.
- Menus may act or appear differently while 4:3 TV Zoom is on.

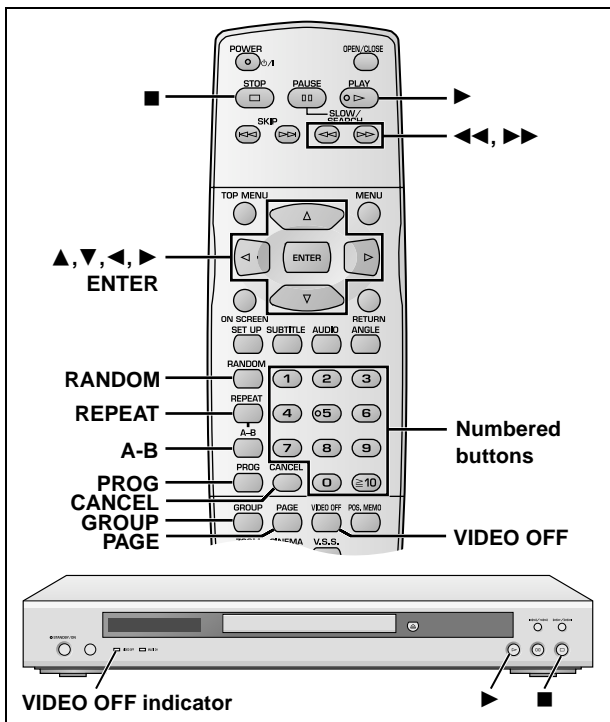

Selecting still pictures—Page Skip

DVD-A

During play or while paused
Press [PAGE].

PAGE 1

The page changes each time you press the button.

To enjoy even higher quality sound—VIDEO OFF

DVD-A DVD-V VCD CD MP3

You can enjoy higher quality audio by stopping the video signal.

During play
Press [VIDEO OFF].

- The indicator on the main unit lights.
- VIDEO OFF is canceled if you press the button again or turn the unit off.

Note

- Video is output when you stop the disc and during operations such as search.
- The television screen can appear unusual while video signals are not being output.

A-B repeat play

DVD-A DVD-V VCD CD MP3

(When the elapsed play time is displayed)

You can repeat a section between points A and B within a title or track.

During play

- 1 Press [A-B] at the starting point (A).
- 2 Press [A-B] at the finishing point (B).



To cancel
Press [A-B] to display “**”.

Note

- Some subtitles recorded around point A or B may fail to appear. DVD-V
- The unit automatically determines the end of a title/track as point B when the end of the title/track is reached.

Selecting groups to play

DVD-A MP3

The tracks on DVD-Audio and MP3 are divided into groups. How these groups are played depends on the recording method.

- 1 Press [GROUP].
The group number changes each time you press the button.
- 2 Press [ENTER].
- 3 Press the numbered buttons to select the track number and press [ENTER].
The selected group and track begin to play.

e.g. MP3

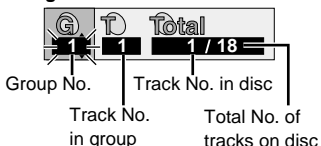

Note

- You can also select groups and tracks with the cursor buttons.
- Selection may not be allowed in some situations.

DVD-A

Playing all the groups in succession (⇒ page 15, All group play)

Playing bonus groups

DVD-A

Some discs contain bonus groups. To enjoy these groups you may have to enter a password. Refer to the disc's jacket.

1. Select the bonus group while stopped (⇒ steps 1 and 2, above).
2. Enter the 4-digit password with the numbered buttons.
 - You can erase it by pressing [CANCEL].
3. Press [ENTER].
4. Press the numbered buttons to select a track and press [ENTER] to start play.

Note

- Some discs will show a menu screen to accept your password. Follow the on-screen instructions.
- You may have to reenter the password after removing the disc or switching the unit to standby.

Repeat play

DVD-A DVD-V VCD CD MP3

(When the elapsed play time is displayed)

During play

Press [REPEAT].

The indication changes each time you press the button.

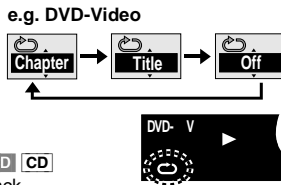

DVD-A MP3	DVD-V	VCD CD
Track	Chapter	Track
Group	Title	All
All#1	All#1	Off
Off	Off	

*1 During all group, program and random play.

If the Video CD has playback control

1. Press [] to clear "PBC" from the display.
2. Press the numbered buttons to select a track to start play (→ page 10).
3. Press [REPEAT] (→ above).

Note

You cannot use repeat play to repeat an entire DVD-Video or an entire MP3 disc.

To repeat only your favorite tracks/chapters

DVD-A DVD-V VCD CD MP3

Start program play (→ right) and press [REPEAT] to display "All".

Random play

DVD-A DVD-V VCD CD MP3

While stopped

1 Press [RANDOM].

2 DVD-A DVD-V

Press the numbered buttons to select a group (DVD-A) or a title (DVD-V).

• Some items cannot be selected. DVD-V

DVD-A

- You can select more than one group. To enter all groups, select "All" using [◀, ▶] and press [ENTER].
- To deselect a group, press the numbered buttons corresponding to the group you want to clear.
- If you select bonus groups, you will have to enter a 4-digit password (→ page 14).

3 Press [▶] (PLAY).

To exit the random mode

Press [RANDOM] while stopped.

e.g. DVD-Video

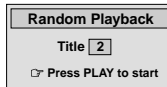

Program play/All group play

DVD-A DVD-V VCD CD MP3

While stopped

Press [PROG].

The display changes each time you press the button.

Program → All group (DVD-A) → Off

Program play

You can select up to 32 items to play in the order you choose.

1 DVD-A DVD-V MP3

Press the numbered buttons to select a group

(DVD-A MP3) or a title (DVD-V).

- Some items cannot be selected. DVD-V
- If you select bonus groups, you will have to enter a 4-digit password (→ page 14). DVD-A

e.g. DVD-Video

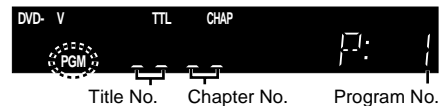
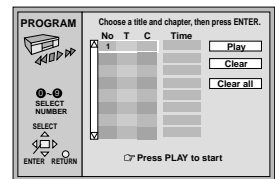

2 Press the numbered buttons to select a track

(DVD-A VCD CD) or a chapter (DVD-V).

(MP3) and press [ENTER].

- Repeat steps 1 and 2 to program other items.
- Times are not displayed when programming DVD-Video and MP3.

3 Press [▶] (PLAY).

Some items will not be played even if you programmed them. DVD-V

To select using the cursor buttons

Press [ENTER] and [▲, ▼] to select an item, then press [ENTER] again to register. Select "ALL" to enter all items (on the disc or in the title or group).

Changing the program

Press [▲, ▼] to select an item.

–To change an item, repeat steps 1 and 2.

–To clear an item, press [CANCEL] (or select "Clear" and press [ENTER]).

Press [◀◀] or [▶▶] to change pages.

To clear the whole program

Move to "Clear all" with [▲, ▼, ◀, ▶] and press [ENTER]. The whole program is also cleared when the unit is turned off or the disc tray is opened.

All group play

DVD-A

The unit plays tracks in all the groups on a disc.

Press [▶] (PLAY).

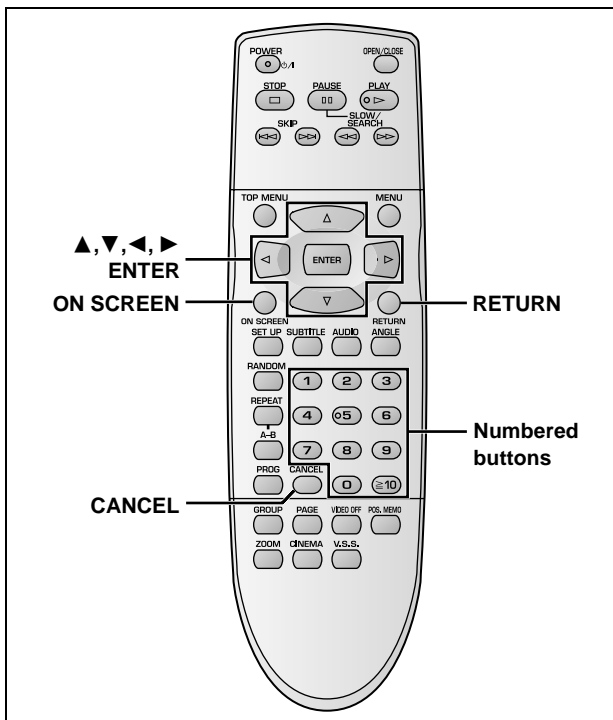

DVD-A DVD-V VCD CD MP3

GUI screens are menus that contain information about the disc or unit. These menus allow you to perform operations by changing this information.

Common procedures

1 Press [ON SCREEN].

Each time you press the button:

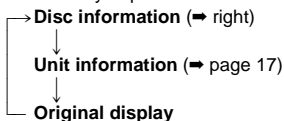

2 Unit information only

While the leftmost icon is highlighted
Press [▲, ▼] to select the menu.

Each time you press the button:

Play Menu ↔ Picture Menu

Display Menu ↔ Audio Menu

3 Press [◀, ▶] to select the item.

4 Press [▲, ▼] to select the setting.

- Items with "▲" or "▼" above and below can be changed by [▲, ▼].
- Press [ENTER] if the setting does not change after pressing [▲, ▼].
- Some items require different operations. Read the following explanations.

For your reference

- Depending on the condition of the unit (playing, stopped, etc.) and the type of software, there are some items that you cannot select or change.
- When numbers are displayed (e.g. title No.), the numbered buttons are also effective for setting. Press [ENTER] to register the setting.

To clear the menus

Press [RETURN] until the menu disappears.

■ To change the position of the icons

1. Press [◀, ▶] to select the Bar Position icon
2. Press [▲, ▼] to move the icons. (There are 5 positions.)



Disc information

e.g. DVD-Video

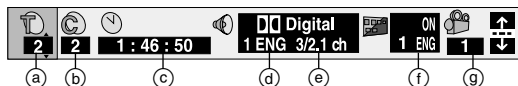

e.g. MP3 disc



e.g. Video CD

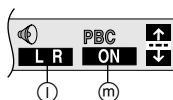

e.g. DVD-Audio

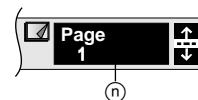

- (a) **T: Title number** DVD-V
Track number VCD CD
- G: Group number** DVD-A MP3
- (b) **T: Track number in group** DVD-A MP3
- C: Chapter number** DVD-V
- (c) **Time** DVD-A DVD-V
 - Press [▲, ▼] to show the elapsed play time or remaining time for the group, track or title (or chapter during program and random play).
 - Select a position to start play by specifying a time with the numbered buttons and press [ENTER].
- Changing the time display** VCD CD
Press [▲, ▼] to show the elapsed play time, remaining time for the track, or remaining time for the disc.
- Elapsed play time** MP3
(display only, cannot be changed)
- (d) **Soundtrack language** DVD-A DVD-V (→ page 13)
(See [A] on page 13 for language abbreviations.)
- (e) **Audio signal type** DVD-A DVD-V (→ page 13)
(See [B] on page 13 for details.)
Karaoke vocal on/off (Karaoke DVD only) DVD-V
Solo: OFF or ON
Duet: OFF, V1 + V2, V1 or V2
- (f) **Subtitle language** DVD-A DVD-V (→ page 13)
(See [A] on page 13 for language abbreviations.)
Subtitles on/off DVD-A DVD-V
ON ↔ OFF
Track information on/off MP3 CD (CD text)
ON ↔ OFF
- (g) **Angle number** DVD-A DVD-V (→ page 13)
- (h) **Track number in disc** MP3
- (i) **Total number of tracks on disc** MP3
- (j) **Current bitrate** MP3
- (k) **Current sampling frequency** MP3
- (l) **Audio mode** VCD (→ page 13)
LR ↔ L ↔ R
- (m) **Menu play** VCD (with playback control only)
Indicates whether menu play (playback control) is on or off.
- (n) **Still picture number** DVD-A
Selected picture is shown during play.

Unit information

Play Menu

e.g. DVD-Video

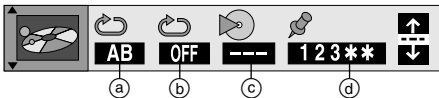

- (a) **A-B repeat** **DVD-A** **DVD-V** **VCD** **CD** **MP3** (⇒ page 14)
[ENTER] (start point) ⇒ [ENTER] (finish point)
To cancel: [ENTER]
- (b) **Repeat mode** (⇒ page 15)
DVD-A **MP3** **DVD-V** **VCD** **CD**
T: Track C: Chapter T: Track
G: Group T: Title A: All
A: All*1 A: All*1 OFF: Off
OFF: Off OFF: Off

*1 During all group, program and random play

- (c) **Play mode display** **DVD-A** **DVD-V** **VCD** **CD** **MP3**

---: Normal play
PGM: Program play
RND: Random play
ALL: All group play (**DVD-A**)

- (d) **Marker**

DVD-A **DVD-V** **VCD** **CD** **MP3**: 5 positions

[ENTER] (The unit is now ready to accept markers.)
To mark a position: [ENTER] (at the desired point)
To mark another position: [◀, ▶] ⇒ [ENTER]
To recall a marker: [◀, ▶] ⇒ [ENTER]
To erase a marker: [◀, ▶] ⇒ [CANCEL]

Note

- This feature doesn't work during program and random play.
- All the markers are cleared when the disc tray is opened or the unit is switched to standby.

Audio Menu

e.g. DVD-Video

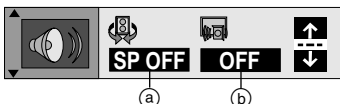

- (a) **Advanced Surround** **DVD-V** **VCD** (⇒ page 12)
• **VSS mode**
SP ↔ HP
• **SP/HP level**
1 ↔ 2 ↔ OFF
- (b) **Dialogue Enhancer** **DVD-V** (⇒ page 12)
ON ↔ OFF

Display Menu

e.g. DVD-Video

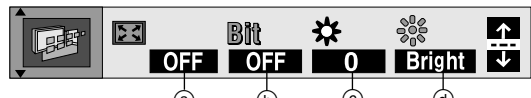

- (a) **4:3 TV Zoom** **DVD-A** **DVD-V** (⇒ page 13)
ON ↔ OFF
- (b) **Bitrate display** **DVD-A** **DVD-V** **VCD**
Displays the bitrate (approximate values) and type of picture (⇒ page 22, Glossary—I/P/B)
ON ↔ OFF
To change the bitrate display: [◀, ▶]
• During play: shows the average bitrate of the video being played
While paused: shows the data volume of the frame
• A record of bitrates for a sampling period.
-
- (c) **OSD brightness** (−3 to +3)
Adjust the brightness of the on-screen displays.
- (d) **FL dimmer** **DVD-A** **DVD-V** **VCD** **CD** **MP3**
Changes the brightness of the unit's display.
Bright ↔ Dim ↔ Auto*2 (**DVD-A** **DVD-V** **VCD**)
*2 The display is dimmed during play, but brightens when you perform operations such as slow-motion, search, and pause.

Picture Menu

DVD-A **DVD-V** **VCD**

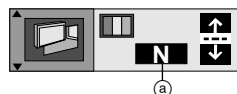

User mode

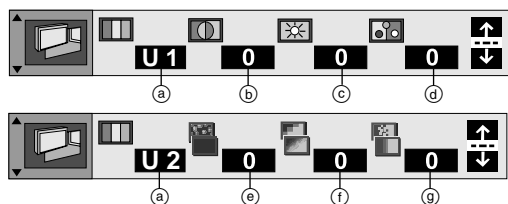

- (a) **Picture mode**
• **N**: Normal mode
• **C1**: Mellows images and enhances detail in dark scenes
• **C2**: Sharpens images and enhances detail in dark scenes
• **U1/U2**: User mode

User mode

To change the user mode

1. Select User mode and press [▶] to highlight the number.
2. Press [▲, ▼] to select "1" or "2".



—Picture Control—

- (b) **Contrast** (−7 to +7)
Increases the contrast between light and dark parts of the picture.
- (c) **Brightness** (0 to +15)
Brightens the picture.
- (d) **Colour** (−7 to +7)
Adjust the shade of the picture's colour.





—MPEG Digital Noise Reduction—

- (e) **3D-NR** (0 to +4)
Reduces overall noise.
- (f) **Block NR** (0 to +3)
Smooths block noise.
- (g) **Mosquito NR** (0 to +3)
Reduces the smudging that appears around contrasting sections of the picture.

Changing settings

This chart shows the settings for this unit. Change the settings to suit your preferences and to suit the unit to the environment in which it is being used. These settings are retained in memory until they are changed, even if the unit is turned off. See page 19 for details on menu operation.

• Underlined items are the factory preset.

Menus	Items	Options			
 Disc	Audio Choose the audio language.	English Spanish Original ^{#1}	French Portuguese Other * * * * ^{#2}	German Swedish	Italian Dutch
	Subtitle Choose the subtitle language.	Automatic ^{#3} Italian Dutch	English Spanish Other * * * * ^{#2}	French Portuguese	German Swedish
	Menus Choose the language for disc menus.	English Spanish Other * * * * ^{#2}	French Portuguese	German Swedish	Italian Dutch
	Ratings Set a ratings level to limit DVD-Video play. • The password screen is shown if you choose levels 0 to 7 or if you choose "Ratings" when levels 0 to 7 have been selected (⇒ page 19). • Select "Level 0" to prevent play of discs that do not have ratings levels recorded on them.	Setting ratings (When level 8 is selected) 8 <u>No Limit</u> 1 to 7 ^{#4} 0 Lock All <hr/> Changing ratings (When level 0-7 is selected) Unlock Player Change Level Change Password Temporary Unlock			
 Video	TV Aspect (⇒ page 8) Choose the setting to suit your television and preference.	<u>4:3 Pan&Scan</u>	4:3 Letterbox	16:9	
	AV Output (⇒ page 7) Choose the video signal format to be output from the SCART terminal.	<u>Video</u>	S-Video	RGB	
	Still Mode (⇒ page 22, Glossary—Frame still and field still) Specify the type of picture shown when paused.	<u>Automatic</u>	Field	Frame	
	NTSC Disc Output Choose whether PAL60 or NTSC signals are output during playback of NTSC discs (⇒ page 4, Video systems)	<u>PAL60</u> : when connected to a PAL television. NTSC: when connected to an NTSC television.			
 Audio	Speaker Setting (⇒ page 20) Choose the settings to suit your audio system and the listening environment.	<u>Multi-channel</u> : when 3 or more speakers are connected. • Speaker presence and size • Delay time • Channel balance <hr/> 2-channel: when 2 speakers or an amplifier with a Dolby Pro Logic decoder is connected.			
	Digital Audio Output (⇒ page 19, Digital output)	<u>On</u>	Off		
	PCM Down Conversion (⇒ page 19)	<u>No</u>	Yes		
	Dolby Digital (⇒ page 19)	<u>Bitstream</u>	PCM		
	DTS Digital Surround (⇒ page 19)	<u>PCM</u>	Bitstream		
	MPEG (⇒ page 19)	<u>PCM</u>	Bitstream		
	Dynamic Range Compression (Dolby Digital only) (⇒ page 22, Glossary) Change the dynamic range for late night viewing.	<u>Off</u>	On		
	Audio during Search ^{#5} Choose whether to have sound during search.	<u>On</u>	Off		
 Display	Menu Language Choose the language for these menus and the on-screen messages.	English Español	Français Português	Deutsch Svenska	Italiano Nederlands
	On-Screen Messages Choose whether to show on-screen messages or not.	<u>On</u>	Off		
 Others	DVD-Video Mode Select how to play pictures contained on some DVD-Audio. The setting returns to "Off" when you remove the disc or turn the unit off.	<u>Off</u> : DVD-Audio are played as DVD-Audio. On: DVD-Video contents found on DVD-Audio can be played.			
	Demo A demonstration of the unit's on-screen displays starts when you select "On". The demonstration stops when you press a button and the setting reverts to "Off".	<u>Off</u>	On		
	QUICK SETUP (⇒ page 8) Answer questions to make basic settings.	Yes	<u>No</u>		

^{#1} The original language of each disc will be selected.

^{#2} Input a code number with the numbered buttons (⇒ page 20).

^{#3} If the language selected for "Audio" is not available, subtitles of that language will automatically appear if available on that disc.

^{#4} Prohibits play of DVD-Video with corresponding ratings recorded on them.

^{#5} This feature doesn't work for DTS-CD discs. Audio will be heard when playing some DVD-Audio despite the settings you make here.

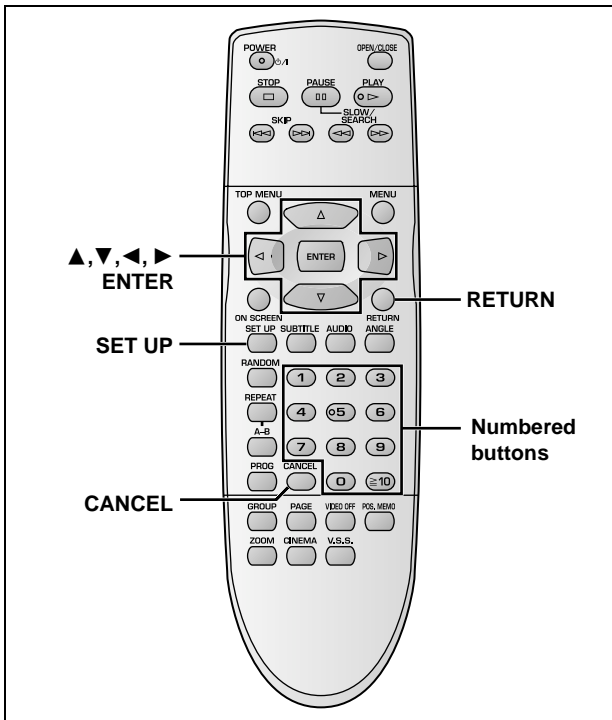

Entering a password (Ratings)

DVD-V

The password screen is shown when you select levels 0 to 7.

1. Input a 4-digit password with the numbered buttons.
 - If you enter a wrong number, press [CANCEL] to erase it.
2. Press [ENTER].
 - The lock symbol appears closed to show the rating is locked.
 - **Do not forget your password.**
3. Press [ENTER] to confirm the 4 digits.

Now, when you insert a DVD-Video that exceeds the ratings limit you set, a message appears on the television. Follow the on-screen instructions.

Digital output

DVD-A DVD-V

Change the settings when you have connected equipment through this unit's DIGITAL OUT terminal (OPTICAL or COAXIAL).

Digital Audio Output

Select whether to output digital signals or not.

- **On:** Digital signals are output.
- **Off:** Digital signals are not output.

PCM Down Conversion

Select how to output audio with a sampling frequency of 96 kHz or 88.2 kHz.

- Select "Yes" if the equipment you connect cannot process signals with a sampling frequency of 96 kHz or 88.2 kHz.
- Also make the appropriate "Digital Audio Output" setting (➡ above).

No (Factory preset): Output as 96 kHz or 88.2 kHz

Yes: Converted to 48 kHz or 44.1 kHz

Note

- Signals are converted to either 48 kHz or 44.1 kHz despite the above settings if the signals have a sampling frequency of over 96 kHz, or the disc has copy protection.
- Some equipment cannot handle sampling frequencies of 88.2 kHz, even if they can handle 96 kHz. Read your equipment's operating instructions for details.

Dolby Digital, DTS Digital Surround and MPEG

Bitstream (Factory preset for Dolby Digital):

Select if the equipment you connected can decode the signal.

PCM (Factory preset for DTS Digital Surround and MPEG):

Select if the equipment you connected cannot decode the signal.

IMPORTANT

If the equipment you connected cannot decode the signal, the setting must be changed to PCM. If not, signals the equipment cannot process will be output by this unit, causing high levels of noise which can damage your hearing and the speakers.

Common procedures

See page 18 for menu and option details.

1 Press [SET UP] to show the menus.

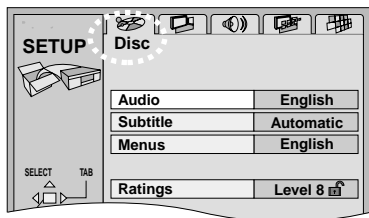

- The QUICK SETUP screen appears when you press [SET UP] the first time after purchase (➡ page 8).

2 Press [◀, ▶] to select the menu's tab.

The screen changes to display the menu.

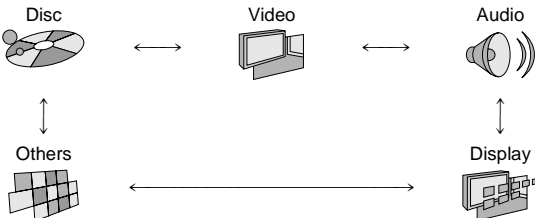

3 Press [▲, ▼] to select the item you want to change and press [ENTER].

4 Press [▲, ▼, ▶, ◀] to select the option and press [ENTER].

The screen now shows the menu again.

To return to the previous screen

Press [RETURN].

To exit the SETUP menu

Press [SET UP].

Speaker setting

Change speaker presence and size (a), delay time (b), and channel balance (c) to suit the speakers you have connected. These settings are not necessary when you select "2-channel" (only two speakers are connected).

Note

This feature works only for analogue connection (→ page 6 B).

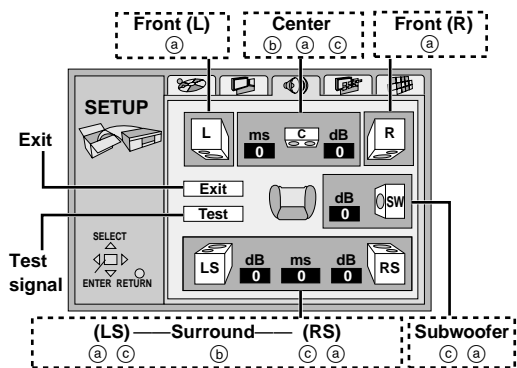

Delay time (b)

DVD-V (Dolby Digital, center and surround speakers only)

For optimum listening with 5.1-channel sound, all the speakers, except for the subwoofer, should be the same distance from the seating position. If you have to place the center or surround speakers closer to the seating position, adjust the delay time to make up for the difference.

d Center speaker

Difference	Setting
Approx. 50 cm	1.3 ms
Approx. 100 cm	2.6 ms
Approx. 150 cm	3.9 ms
Approx. 200 cm	5.3 ms

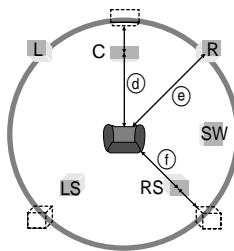

f Surround speakers

Difference	Setting
Approx. 200 cm	5.3 ms
Approx. 400 cm	10.6 ms
Approx. 600 cm	15.9 ms

If distances (a) (from the center speaker) and (i) (from the surround speakers) are the same as or greater than (e) (from the front speakers), leave the delay time as "0", the factory preset.

If either distance (a) or (i) is less than (e), find the difference in the relevant table and change to the recommended setting.

Speaker presence and size (a)

- Press [▲, ▼, ◀, ▶] to select the item and press [ENTER].
- Press [▲, ▼] to select the setting and press [ENTER].

Icon examples:

Surround speaker (LS)



No



Large



Small

- **Large:** When the speaker supports low-frequency (under 100 Hz) reproduction.
- **Small:** Select when the speaker does not support low-frequency reproduction.

If the subwoofer is set to No, the front speakers will automatically be set to Large.

Changing the delay time

- Press [▲, ▼, ◀, ▶] to select the delay time box and press [ENTER].
- Press [▲, ▼] to adjust the delay time and press [ENTER].

Channel balance (c)

- Press [▲, ▼, ◀, ▶] to select "Test" and press [ENTER].
A test signal is output from one speaker at a time, starting with the front left speaker and proceeding clockwise.
Front (L) → Center → Front (R)
↑ ↓
Surround (LS) ← Surround (RS)
- While listening to the test signal, press [▲, ▼] to adjust the volume of the center and surround speakers so they are the same apparent volume as the front speakers (-6 to +6).
(The front speakers cannot be adjusted here.)
- Press [ENTER].
The test signal stops.
• No signal is output for the subwoofer. To adjust its volume, play something, then return to this screen to adjust to suit your taste.

To finish the speaker setting

Press [▲, ▼, ◀, ▶] to select "Exit" and press [ENTER].

Note

The unit may be unable to output as set here due to limitations imposed by the unit itself or the disc being played. (The display's "D.MIX" indicator goes out in these cases.)

Language code list

Abkhazian: 6566	Byelorussian: 6669	Georgian: 7565	Kashmiri: 7583	Mongolian: 7778	Serbo-Croatian: 8372	Tigrinya: 8473
Afar: 6565	Cambodian: 7577	German: 6869	Kazakh: 7575	Nauru: 7865	Shona: 8378	Tonga: 8479
Afrikaans: 6570	Catalan: 6765	Greek: 6976	Kirghiz: 7589	Nepali: 7869	Sindhi: 8368	Turkish: 8482
Albanian: 8381	Chinese: 9072	Greenlandic: 7576	Korean: 7579	Norwegian: 7879	Singhalese: 8373	Turkmen: 8475
Ameharic: 6577	Corsican: 6779	Guarani: 7178	Kurdish: 7585	Oriya: 7982	Slovak: 8375	Twi: 8487
Arabic: 6582	Croatian: 7282	Gujarati: 7185	Laotian: 7679	Pashto, Pushto: 8083	Slovenian: 8376	Ukrainian: 8575
Armenian: 7289	Czech: 6783	Hausa: 7265	Latin: 7665	Persian: 7065	Somali: 8379	Urdu: 8582
Assamese: 6583	Danish: 6865	Hebrew: 7387	Latvian, Lettish: 7686	Polish: 8076	Spanish: 6983	Uzbek: 8590
Aymara: 6588	Dutch: 7876	Hindi: 7273	Lingala: 7678	Portuguese: 8084	Sundanese: 8385	Vietnamese: 8673
Azerbaijani: 6590	English: 6978	Hungarian: 7285	Lithuanian: 7684	Punjabi: 8065	Swahili: 8387	Volapük: 8679
Bashkir: 6665	Esperanto: 6979	Icelandic: 7383	Macedonian: 7775	Quechua: 8185	Swedish: 8386	Welsh: 6789
Basque: 6985	Estonian: 6984	Indonesian: 7378	Malagasy: 7771	Rhaeto-Romance: 8277	Tagalog: 8476	Wolof: 8779
Bengali, Bangla: 6678	Faroese: 7079	Interlingua: 7365	Malay: 7783	Romanian: 8279	Tajik: 8471	Xhosa: 8872
Bhutani: 6890	Fiji: 7074	Irish: 7165	Malayalam: 7776	Russian: 8285	Tamil: 8465	Yiddish: 7473
Bihari: 6672	Finnish: 7073	Italian: 7384	Maltese: 7784	Samoan: 8377	Tatar: 8484	Yoruba: 8979
Breton: 6682	French: 7082	Japanese: 7465	Maori: 7773	Sanskrit: 8365	Telugu: 8469	Zulu: 9085
Bulgarian: 6671	Frisian: 7089	Javanese: 7487	Marathi: 7782	Scots Gaelic: 7168	Thai: 8472	
Burmese: 7789	Galician: 7176	Kannada: 7578	Moldavian: 7779	Serbian: 8382	Tibetan: 6679	

Troubleshooting guide

Before requesting service, make the below checks. If you are in doubt about some of the check points, or if the remedies indicated in the chart do not solve the problem, consult your dealer for instructions.

Power		Page
No power.	•Insert the power cable securely into the wall outlet.	7
The unit is automatically switched to the standby mode.	•To conserve power, the unit automatically switches to standby after approximately 30 minutes in the stop mode. Turn the power back to ON.	–

Operation

No response when buttons pressed.	<ul style="list-style-type: none"> •Some operations may be prohibited by the disc. •The unit may not be operating properly due to lightning, static electricity or some other external factor. Reset procedure: Press [POWER ⏻/⏻] to switch the unit to the standby mode and then back to ON. Alternatively, press [POWER ⏻/⏻] to switch the unit to the standby mode, disconnect the power cable, and then reconnect it.	– –
No operations can be performed with the remote control.	<ul style="list-style-type: none"> •Check that the batteries are installed correctly. •The batteries are depleted: Replace them with new ones. •Point the remote control at the remote control sensor and operate. 	8 8 5
Play doesn't start (or stops immediately) when you press [▶] (PLAY).	<ul style="list-style-type: none"> •Condensation has formed: Wait 1 to 2 hours for it to evaporate. •This unit cannot play discs other than the ones listed in these operating instructions. •This unit cannot play DVD-Video with a region number other than "2", "ALL" or multiple region number including "2". •The disc may be dirty and may require cleaning. •Ensure that the disc is installed with the label of the side to be played facing upwards. 	– 4 4 4 9
Cannot select alternative languages.	<ul style="list-style-type: none"> •This function is dependent on software availability. •Try selecting from the disc's menu if one is available. 	– 9
No menu play.	<ul style="list-style-type: none"> •This function is dependent on software availability. 	–
No subtitles.	<ul style="list-style-type: none"> •This function is dependent on software availability. •Subtitles are cleared from the television. Display the subtitles. 	– 13
Soundtrack and/or subtitle language is not the one selected with the SETUP menus.	<ul style="list-style-type: none"> •This function is dependent on software availability. 	–
Cannot change angle.	<ul style="list-style-type: none"> •This function is dependent on software availability. Even if a disc has a number of angles recorded, these angles may be recorded for specific scenes only. 	–
Dialogue Enhancer has no effect.	<ul style="list-style-type: none"> •This feature does not work when the unit is outputting bitstream signals. 	–
You have forgotten your ratings password. Reset all the settings to Factory Preset.	<ul style="list-style-type: none"> •While stopped, press and hold [◀◀/▶▶] and [■] on the unit and then also press and hold [▲] on the unit until "Initialized" disappears from the television. Turn the unit off and on again. All settings will return to the default values. 	–

Picture

Picture distorted.	<ul style="list-style-type: none"> •Some distortion is normal during SEARCH. •The screen may be disrupted briefly when you turn off the VIDEO OFF feature. 	– –
No picture.	<ul style="list-style-type: none"> •Check the connection. •Make sure the television is on. •Ensure the television's video input setting (e.g., VIDEO 1) is correct. 	7 – –
The picture shown on the television is not normal. (The sides of the picture are cut off or black bands appear at the top and bottom of the screen.)	<ul style="list-style-type: none"> •Go to Video in the SETUP menus, and change "TV Aspect" to suit your television. •Use the television to change the aspect to the correct one. •The 4:3 TV Zoom function is on. •Ensure that the unit is not connected through a video cassette recorder. 	18 – 13 7
Picture quality is poor.	<ul style="list-style-type: none"> •Check the settings in the GUI screen's Picture Menu. 	17
The SETUP menus and other screens shown on the television are displayed incorrectly. Colors appear faded.	<ul style="list-style-type: none"> •The unit and television are using different video systems. Use a multi-system or PAL television. 	–

Sound		Page
No sound. Distorted sound.	•Check the connections.	6
	•Check the volume on the equipment you have connected.	–
	•Ensure that the input settings on the other equipment are correct.	–
	•Turn Advanced Surround off if it causes distortion.	12
	•Output from this unit will be in stereo (two channels) when Advanced Surround is on. Turn Advanced Surround off if you are using three or more speakers.	12
Piercing noise comes from the speakers.	•If you have connected this unit to an amplifier through the 6CH DISCRETE terminals, go to the Audio menu in the SETUP menu, and change "Speaker Setting" to suit to your speakers. Select the large or small icon for all the speakers you have connected.	20
	•Due to the specifications on some types of televisions, both video and audio may be cut off when you turn the VIDEO OFF feature on.	–
	•If the "D.MIX" indicator on the display goes out while playing a multi-channel DVD-Audio disc, sound will only be output from speakers specified by the disc. Read the disc's instructions for details.	–
	•If you have connected this unit to other equipment through the DIGITAL OUT terminal, ensure you have selected the correct settings for "Dolby Digital", "DTS Digital Surround" and "MPEG" in the SETUP menus' Audio menu.	19

Unit displays

"NoPLAY"	•You inserted a disc the unit cannot play: Insert one it can.	4
"CHECK"	•Disc is dirty: Wipe it clean.	4
"H□□" □□ stands for a number.	•Trouble may have occurred. The number following "H" depends on the status of the unit. Reset procedure: Press [POWER ⏻] to switch the unit to the standby mode and then back to ON. Alternatively, press [POWER ⏻] to switch the unit to the standby mode, disconnect the power cable, and then reconnect it. •If the service numbers fail to clear, note the service number and contact a qualified service person.	–
"NoDISC"	•You haven't inserted a disc: Insert one. •You haven't inserted the disc correctly: Insert it correctly.	– 9

Television displays

No on-screen display.	•Go to Display in the SETUP menus, and select "On" for "On-Screen Messages".	18
On-screen displays (including GUI screens) not displayed or only partially displayed on the television.	•Press [ON SCREEN], and press [◀, ▶] to highlight the Bar Position icon, then press [▲, ▼] to adjust the position.	16
The disc's menu is displayed in a different language.	•Go to Disc in the SETUP menus, and select the preferred language for "Menus".	18

Glossary

Bitstream

This is the digital form of multi-channel audio data (e.g., 5.1 channel) before it is decoded into its various channels.

Decoder

A decoder restores the coded audio signals on DVDs to normal. This is called decoding.

Dolby Digital

This is a method of coding digital signals developed by Dolby Laboratories. Apart from stereo (2-channel) audio, these signals can also be multi-channel audio. A large amount of audio information can be recorded on one disc using this method.

Dolby Pro Logic

A surround system where a 4-channel audio track is recorded as 2 channels and then is restored to 4 channels for play. The surround channel is monaural and can reproduce up to 7 kHz.

DTS (Digital Theater Systems)

This surround system is used in many movie theaters around the world. There is good separation between the channels, so realistic sound effects are possible.

Dynamic range

Dynamic range is the difference between the lowest level of sound that can be heard above the noise of the equipment and the highest level of sound before distortion occurs.

Frame still and field still

Frames are the still pictures that go together to make a moving picture. There are about 30 frames shown each second.

One frame is made up of two fields. A regular television shows these fields one after the other to create frames.

A still is shown when you pause a moving picture. A frame still is made up of two alternating fields, so the picture may appear blurred, but overall quality is high. A field still is not blurred, but it has only half the information of a frame still so picture quality is lower.

I/P/B

MPEG 2, the video compression standard adopted for use with DVD-Video, codes frames using these 3 picture types.

I: Intra coded picture

This picture has the best quality and is the best to use when adjusting the picture.

P: Predictive coded picture

This picture is calculated based on past I or P-pictures.

B: Bidirectionally-predictive coded picture

This picture is calculated by comparing past and future I and P-pictures so it has the lowest volume of information.

Linear PCM (pulse code modulation)

These are uncompressed digital signals, similar to those found on CDs.

Playback control (PBC)

If a Video CD has playback control, you can select scenes and information with menus (called menu play in these instructions).

Specifications

Signal system:	PAL625/50, PAL525/60, NTSC
Operating temperature range:	+5 to +35 °C
Operating humidity range:	5 to 90 % RH (no condensation)
Discs played [8 cm or 12 cm]:	
(1) DVD-Audio	
(2) DVD-Video	
(3) DVD+RW/DVD+R	
(4) DVD-R/DVD-RW (DVD-Video compatible)	
(5) CD-Audio (CD-DA)	
(6) Video CD	
(7) CD-R/CD-RW (CD-DA, Video-CD formatted discs)	
(8) MP3	
•Maximum number of tracks and groups recognizable:	999 tracks and 99 groups
•Compatible compression rate:	between 32 kbps and 320 kbps

Video output:	
Output level:	1 Vp-p (75 Ω)
Output terminal:	Pin jack (1 system)/AV

S video output:	
Y output level:	1 Vp-p (75 Ω)
C output level:	
NTSC;	0.286 Vp-p (75 Ω)
PAL;	0.300 Vp-p (75 Ω)
Output terminal:	S terminal (1 system)/AV

RGB video output:	
R output level:	0.7 Vp-p (75 Ω)
G output level:	0.7 Vp-p (75 Ω)
B output level:	0.7 Vp-p (75 Ω)
Output terminal:	AV

Audio output:	
Output level:	2 Vrms (1 kHz, 0 dB)
Output connector:	Pin jack/AV
Number of connectors:	
2 channel:	1 system
5.1-channel discrete output (5.1 channel):	1 system

Audio performance:	
(1) Frequency response:	
•DVD (linear audio):	2 Hz–22 kHz (48 kHz sampling) 2 Hz–44 kHz (96 kHz sampling) 2 Hz–88 kHz (192 kHz sampling) 2 Hz–20 kHz
•DVD-Audio:	
•CD audio:	
(2) S/N ratio:	
•CD audio:	115 dB
(3) Dynamic range:	
•DVD (linear audio):	102 dB
•CD audio:	98 dB
(4) Total harmonic distortion:	
•CD audio:	0.0025 %

Digital audio output:	
Optical digital output:	Optical terminal
Coaxial digital output:	Pin jack
Pickup:	
Wave length:	658 nm/790 nm
Laser power:	CLASS 2/CLASS 1
Power supply:	AC 220–240 V, 50 Hz
Power consumption:	15 W
Dimensions:	435 (W)×258 (D)×60 (H) mm
Mass:	3.3 kŮ

Power consumption in standby mode:	approx. 4 W
-------------------------------------------	--------------------

Note
Specifications are subject to change without notice.
Mass and dimensions are approximate.

Manufactured under license from Dolby Laboratories.
"Dolby", "Pro Logic" and the double-D symbol are trademarks of Dolby Laboratories.

Manufactured under license from Digital Theater Systems, Inc. US Pat. No.5,451,942, 5,956,674, 5,974,380, 5,978,762 and other world-wide patents issued and pending. "DTS" and "DTS Digital Surround" are registered trademarks of Digital Theater Systems, Inc. © 1996, 2000 Digital Theater Systems, Inc. All rights reserved.

This product incorporates copyright protection technology that is protected by method claims of certain U.S. patents and other intellectual property rights owned by Macrovision Corporation and other rights owners. Use of this copyright protection technology must be authorized by Macrovision Corporation, and is intended for home and other limited viewing uses only unless otherwise authorized by Macrovision Corporation. Reverse engineering or disassembly is prohibited.