

Clavinova®

OWNER'S MANUAL

CLP-480

MODE D'EMPLOI

MANUAL DE INSTRUCCIONES

ENGLISH

FRANÇAIS

ESPAÑOL

IMPORTANT

— Check your power supply —

Make sure that your local AC mains voltage matches the voltage specified on the name plate on the bottom panel. In some areas a voltage selector may be provided on the rear panel of the main keyboard unit near the power cord. Make sure that the voltage selector is set for the voltage in your area. The voltage selector is set at 240V when the unit is initially shipped. To change the setting use a "minus" screwdriver to rotate the selector dial so that the correct voltage appears next to the pointer on the panel.

For information on assembling the instrument, refer to the instructions at the end of this manual.

IMPORTANT

— Vérifiez votre alimentation électrique —

Vérifiez que la tension de l'alimentation secteur correspond à celle indiquée sur la plaque du fabricant, située sur le panneau inférieur. Les instruments destinés à certaines régions disposent d'un sélecteur de tension. Il est installé sur le panneau arrière de l'unité principale du clavier, à côté du câble d'alimentation. Assurez-vous que ce sélecteur est réglé sur la tension utilisée dans votre pays. À sa sortie d'usine, le sélecteur est réglé sur 240 V. Pour modifier ce réglage, utilisez un tournevis plat et faites tourner le cadran du sélecteur jusqu'à ce que la valeur correcte apparaisse à côté de l'indicateur figurant sur le panneau.

Pour plus d'informations sur l'assemblage de l'instrument, reportez-vous aux instructions figurant à la fin de ce manuel.

IMPORTANTE

— Revise la fuente de alimentación —

Asegúrese de que la tensión de la red eléctrica local de CA coincida con la tensión especificada en la placa del panel inferior. Es posible que, en algunas zonas, se suministre un selector de tensión en el panel posterior del teclado principal, junto al cable de alimentación. Asegúrese de que este selector esté ajustado según la tensión de la zona. El selector viene ajustado de fábrica para 240 V. Para cambiar el ajuste, utilice un destornillador de punta normal para girar el selector hasta que la tensión correcta aparezca al lado del puntero del panel.

Para obtener más información sobre el montaje del instrumento, consulte las instrucciones que encontrará al final de este manual.

EN

FR

ES

SPECIAL MESSAGE SECTION

PRODUCT SAFETY MARKINGS: Yamaha electronic products may have either labels similar to the graphics shown below or molded/stamped facsimiles of these graphics on the enclosure. The explanation of these graphics appears on this page. Please observe all cautions indicated on this page and those indicated in the safety instruction section.

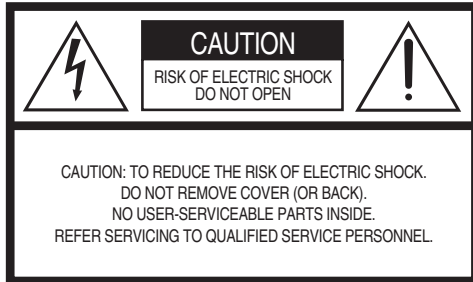

See bottom of Keyboard enclosure for graphic symbol markings.



The exclamation point within the equilateral triangle is intended to alert the user to the presence of important operating and maintenance (servicing) instructions in the literature accompanying the product.



The lightning flash with arrowhead symbol, within the equilateral triangle, is intended to alert the user to the presence of uninsulated “dangerous voltage” within the product’s enclosure that may be of sufficient magnitude to constitute a risk of electrical shock.

IMPORTANT NOTICE: All Yamaha electronic products are tested and approved by an independent safety testing laboratory in order that you may be sure that when it is properly installed and used in its normal and customary manner, all foreseeable risks have been eliminated. **DO NOT** modify this unit or commission others to do so unless specifically authorized by Yamaha. Product performance and/or safety standards may be diminished. Claims filed under the expressed warranty may be denied if the unit is/has been modified. Implied warranties may also be affected.

SPECIFICATIONS SUBJECT TO CHANGE: The information contained in this manual is believed to be correct at the time of printing. However, Yamaha reserves the right to change or modify any of the specifications without notice or obligation to update existing units.

ENVIRONMENTAL ISSUES: Yamaha strives to produce products that are both user safe and environmentally friendly. We sincerely believe that our products and the production methods used to produce them, meet these goals. In keeping with both the letter and the spirit of the law, we want you to be aware of the following:

Battery Notice: This product MAY contain a small non-rechargeable battery which (if applicable) is soldered in place. The average life span of this type of battery is approximately five years. When replacement becomes necessary, contact a qualified service representative to perform the replacement.

Warning: Do not attempt to recharge, disassemble, or incinerate this type of battery. Keep all batteries away from children. Dispose of used batteries promptly and as regulated by applicable laws. Note: In some areas, the servicer is required by law to return the defective parts. However, you do have the option of having the servicer dispose of these parts for you.

Disposal Notice: Should this product become damaged beyond repair, or for some reason its useful life is considered to be at an end, please observe all local, state, and federal regulations that relate to the disposal of products that contain lead, batteries, plastics, etc.

NOTICE: Service charges incurred due to lack of knowledge relating to how a function or effect works (when the unit is operating as designed) are not covered by the manufacturer’s warranty, and are therefore the owners responsibility. Please study this manual carefully and consult your dealer before requesting service.

NAME PLATE LOCATION: The graphic below indicates the location of the name plate. The model number, serial number, power requirements, etc., are located on this plate. You should record the model number, serial number, and the date of purchase in the spaces provided below and retain this manual as a permanent record of your purchase.

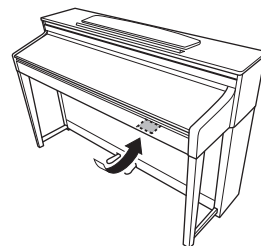

Model _____

Serial No. _____

Purchase Date _____

FCC INFORMATION (U.S.A.)

1. IMPORTANT NOTICE: DO NOT MODIFY THIS UNIT!

This product, when installed as indicated in the instructions contained in this manual, meets FCC requirements. Modifications not expressly approved by Yamaha may void your authority, granted by the FCC, to use the product.

2. IMPORTANT:

When connecting this product to accessories and/or another product use only high quality shielded cables. Cable/s supplied with this product MUST be used. Follow all installation instructions. Failure to follow instructions could void your FCC authorization to use this product in the USA.

3. NOTE:

This product has been tested and found to comply with the requirements listed in FCC Regulations, Part 15 for Class "B" digital devices. Compliance with these requirements provides a reasonable level of assurance that your use of this product in a residential environment will not result in harmful interference with other electronic devices. This equipment generates/uses radio frequencies and, if not installed and used according to the instructions found in the users manual, may cause interference harmful to the operation of other electronic devices. Compliance with FCC regulations

does not guarantee that interference will not occur in all installations. If this product is found to be the source of interference, which can be determined by turning the unit "OFF" and "ON"; please try to eliminate the problem by using one of the following measures:

Relocate either this product or the device that is being affected by the interference.

Utilize power outlets that are on different branch (circuit breaker or fuse) circuits or install AC line filter/s. In the case of radio or TV interference, relocate/reorient the antenna. If the antenna lead-in is 300 ohm ribbon lead, change the lead-in to co-axial type cable.

If these corrective measures do not produce satisfactory results, please contact the local retailer authorized to distribute this type of product. If you can not locate the appropriate retailer, please contact Yamaha Corporation of America, Electronic Service Division, 6600 Orangethorpe Ave, Buena Park, CA90620

The above statements apply ONLY to those products distributed by Yamaha Corporation of America or its subsidiaries.

* This applies only to products distributed by YAMAHA CORPORATION OF AMERICA.

(class B)

COMPLIANCE INFORMATION STATEMENT (DECLARATION OF CONFORMITY PROCEDURE)

Responsible Party : Yamaha Corporation of America
Address : 6600 Orangethorpe Ave.,
Buena Park, Calif. 90620
Telephone : 714-522-9011
Type of Equipment : Digital Piano
Model Name : CLP-480

This device complies with Part 15 of the FCC Rules.

Operation is subject to the following two conditions:

- 1) this device may not cause harmful interference, and
- 2) this device must accept any interference received including interference that may cause undesired operation.

See user manual instructions if interference to radio reception is suspected.

*This applies only to products distributed by
YAMAHA CORPORATION OF AMERICA.

(FCC DoC)

IMPORTANT NOTICE FOR THE UNITED KINGDOM Connecting the Plug and Cord

IMPORTANT. The wires in this mains lead are coloured in accordance with the following code:

BLUE : NEUTRAL
BROWN : LIVE

As the colours of the wires in the mains lead of this apparatus may not correspond with the coloured markings identifying the terminals in your plug proceed as follows:

The wire which is coloured BLUE must be connected to the terminal which is marked with the letter N or coloured BLACK.

The wire which is coloured BROWN must be connected to the terminal which is marked with the letter L or coloured RED.

Making sure that neither core is connected to the earth terminal of the three pin plug.

•This applies only to products
distributed by Yamaha Music U.K. Ltd.

(2 wires)

PRECAUTIONS

PLEASE READ CAREFULLY BEFORE PROCEEDING

* Please keep this manual in a safe place for future reference.



WARNING

Always follow the basic precautions listed below to avoid the possibility of serious injury or even death from electrical shock, short-circuiting, damages, fire or other hazards. These precautions include, but are not limited to, the following:

Power supply/Power cord

- Do not place the power cord near heat sources such as heaters or radiators, and do not excessively bend or otherwise damage the cord, place heavy objects on it, or place it in a position where anyone could walk on, trip over, or roll anything over it.
- Only use the voltage specified as correct for the instrument. The required voltage is printed on the name plate of the instrument.
- Use only the supplied power cord/plug.
- Check the electric plug periodically and remove any dirt or dust which may have accumulated on it.

Do not open

- This instrument contains no user-serviceable parts. Do not open the instrument or attempt to disassemble or modify the internal components in any way. If it should appear to be malfunctioning, discontinue use immediately and have it inspected by qualified Yamaha service personnel.

Water warning

- Do not expose the instrument to rain, use it near water or in damp or wet conditions, place on it any containers (such as vases, bottles or glasses) containing liquids which might spill into any openings. If any liquid such as water seeps into the instrument, turn off the power immediately and unplug the power cord from the AC outlet. Then have the instrument inspected by qualified Yamaha service personnel.
- Never insert or remove an electric plug with wet hands.

Fire warning

- Do not put burning items, such as candles, on the unit. A burning item may fall over and cause a fire.

If you notice any abnormality

- When one of the following problems occur, immediately turn off the power switch and disconnect the electric plug from the outlet. Then have the device inspected by Yamaha service personnel.
 - The power cord or plug becomes frayed or damaged.
 - It emits unusual smells or smoke.
 - Some object has been dropped into the instrument.
 - There is a sudden loss of sound during use of the instrument.



CAUTION

Always follow the basic precautions listed below to avoid the possibility of physical injury to you or others, or damage to the instrument or other property. These precautions include, but are not limited to, the following:

Power supply/Power cord

- Do not connect the instrument to an electrical outlet using a multiple-connector. Doing so can result in lower sound quality, or possibly cause overheating in the outlet.
- When removing the electric plug from the instrument or an outlet, always hold the plug itself and not the cord. Pulling by the cord can damage it.
- Remove the electric plug from the outlet when the instrument is not to be used for extended periods of time, or during electrical storms.

Assembly

- Read carefully the attached documentation explaining the assembly process. Failure to assemble the instrument in the proper sequence might result in damage to the instrument or even injury.

Location

- Do not place the instrument in an unstable position where it might accidentally fall over.
- When transporting or moving the instrument, always use two or more people. Attempting to lift the instrument by yourself may damage your back, result in other injury, or cause damage to the instrument itself.
- Before moving the instrument, remove all connected cables.
- When setting up the product, make sure that the AC outlet you are using is easily accessible. If some trouble or malfunction occurs, immediately turn off the power switch and disconnect the plug from the outlet. Even when the power switch is turned off, electricity is still flowing to the product at the minimum level. When you are not using the product for a long time, make sure to unplug the power cord from the wall AC outlet.

Connections

- Before connecting the instrument to other electronic components, turn off the power for all components. Before turning the power on or off for all components, set all volume levels to minimum.
- Be sure to set the volumes of all components at their minimum levels and gradually raise the volume controls while playing the instrument to set the desired listening level.

Handling caution

- Do not insert a finger or hand in any gaps on the key cover or instrument. Also take care that the key cover does not pinch your finger.
- Never insert or drop paper, metallic, or other objects into the gaps on the key cover, panel or keyboard. This could cause physical injury to you or others, damage to the instrument or other property, or operational failure.
- Do not rest your weight on, or place heavy objects on the instrument, and do not use excessive force on the buttons, switches or connectors.
- Do not use the instrument/device or headphones for a long period of time at a high or uncomfortable volume level, since this can cause permanent hearing loss. If you experience any hearing loss or ringing in the ears, consult a physician.

Using the bench (If included)

- Do not place the bench in an unstable position where it might accidentally fall over.
- Do not play carelessly with or stand on the bench. Using it as a tool or stepladder or for any other purpose might result in accident or injury.
- Only one person should sit on the bench at a time, in order to prevent the possibility of accident or injury.
- For benches that can be adjusted, do not attempt to adjust the bench height while sitting on the bench, since this can cause excessive force to be imposed on the adjustment mechanism, possibly resulting in damage to the mechanism or even injury.
- If the bench screws become loose due to extensive long-term use, tighten them periodically using the included tool.

Yamaha cannot be held responsible for damage caused by improper use or modifications to the instrument, or data that is lost or destroyed.

Always turn the power off when the instrument is not in use.

NOTICE

To avoid the possibility of malfunction/ damage to the product, damage to data, or damage to other property, follow the notices below.

■ Handling and Maintenance

- Do not use the instrument in the vicinity of a TV, radio, stereo equipment, mobile phone, or other electric devices. Otherwise, the instrument, TV, or radio may generate noise.
- Do not expose the instrument to excessive dust or vibrations, or extreme cold or heat (such as in direct sunlight, near a heater, or in a car during the day) to prevent the possibility of panel disfiguration, damage to the internal components or unstable operation. (Verified operating temperature range: 5° – 40°C, or 41° – 104°F.)
- Do not place vinyl, plastic or rubber objects on the instrument, since this might discolor the panel or keyboard.
- In the case of a model with a polished finish, bumping the surface of the instrument with metal, porcelain, or other hard objects can cause the finish to crack or peel. Use caution.
- During extreme changes in temperature or humidity, condensation may occur and water may collect on the surface of the instrument. If water is left, the wooden parts may absorb the water and be damaged. Make sure to wipe any water off immediately with a soft cloth.

■ Saving data

- Saved data may be lost due to malfunction or incorrect operation. Save important data to a USB storage device/external device such as a computer.
- To protect against data loss through media damage, we recommend that you save your important data onto two USB storage devices.

Information

■ About copyrights

- Copying of the commercially available musical data including but not limited to MIDI data and/or audio data is strictly prohibited except for your personal use.
- This product incorporates and bundles computer programs and contents in which Yamaha owns copyrights or with respect to which it has license to use others' copyrights. Such copyrighted materials include, without limitation, all computer software, style files, MIDI files, WAVE data, musical scores and sound recordings. Any unauthorized use of such programs

and contents outside of personal use is not permitted under relevant laws. Any violation of copyright has legal consequences. **DON'T MAKE, DISTRIBUTE OR USE ILLEGAL COPIES.**

■ About functions/data bundled with the instrument

- Some of the Preset Songs have been edited for length or arrangement, and may not be exactly the same as the original.
- This device is capable of using various types/formats of music data by optimizing them to the proper format music data for use with the device in advance. As a result, this device may not play them back precisely as their producers or composers originally intended.

■ About this manual

- The illustrations and LCD screens as shown in this manual are for instructional purposes only, and may appear somewhat different from those on your instrument.
- Windows is a registered trademark of Microsoft® Corporation in the United States and other countries.
- Apple, Mac and Macintosh are trademarks of Apple Inc., registered in the U.S. and other countries.
- The company names and product names in this manual are the trademarks or registered trademarks of their respective companies.

This instrument is compatible with the following formats.

GM System Level 2

“GM (General MIDI)” is one of the most common Voice allocation formats. “GM System Level 2” is a standard specification that enhances the original “GM” and improves Song data compatibility. It provides for increased polyphony, greater Voice selection, expanded Voice parameters, and integrated effect processing.

XG

XG is a major enhancement of the GM System Level 1 format, and was developed by Yamaha specifically to provide more Voices and variations, as well as greater expressive control over Voices and effects, and to ensure compatibility of data well into the future.

GS

GS was developed by the Roland Corporation. In the same way as Yamaha XG, GS is a major enhancement of the GM specifically to provide more Voices and Drum kits and their variations, as well as greater expressive control over Voices and effects.

Thank you for choosing the Yamaha Clavinova.

In order to make the most of your Clavinova's performance potential and features, please read this Owner's Manual thoroughly, and keep it in a safe place for later reference.

Included Accessories

- **Owner's Manual (this book)**
- **Data List**
- **"50 greats for the Piano" (Music Book)**
- **My Yamaha Product User Registration**
The PRODUCT ID on the sheet will be needed when you fill out the User Registration form.
- **AC power cord**
- **Bench (included or optional depending on locale)**

About the Manuals

This instrument has the following documents and instructional materials.

■ Included Documents



Owner's Manual (this book)

This document explains how to use the Clavinova.

• **Introduction:**

This section explains how to set up and start using your Clavinova. Setup is so simple, you can start playing right away.

• **Advanced Functions:**

This section explains various functions useful for your practice, such as Preset Song playback and Song recording.

• **Detailed Settings:**

This section explains how to make detailed settings for the Clavinova's various functions. Refer to this section as necessary.

• **Appendix:**

This section introduces Message List, a description of Preset Voices, and other reference material.



Data List

This document contains lists of XG Voices and Effect types that can be selected by [VOICE SETTING].

■ Online Materials (Downloadable from the web)



Data List Complete Version

This includes all data lists relevant to the instrument, including the data lists included with the instrument, as well as those for Effects, MIDI-related information and so on.



MIDI Basics (only in English, French and German)

If you want to know more about MIDI and how to use it, refer to this introductory book.

These materials are available for downloading from the internet web site, Yamaha Manual Library. Visit the following URL, enter "CLP-480" or "MIDI Basics" to the Model Name box to search for the above materials.

Yamaha Manual Library
<http://www.yamaha.co.jp/manual/>

Main Features

Real Grand Expression (RGE) Sound Engine

This lets you enjoy the playing response and expressive capability of a concert grand piano. In addition to providing smooth tonal changes that respond to your playing touch, it also features a new Smooth Release function which can clearly enunciate staccato notes and produce the sound of lingering resonance when gently lifting your fingers from the keys. It succeeds in capturing the essence of a piano performance to create grand piano-like, richly expressive experiences.

GP Soundboard Speakers for simulating a Grand Piano

This special speaker system, located on the rear panel, will simulate or produce the reverberation and spaciousness of the sound as if there were the soundboard of a grand piano.

NW (Natural Wood) keyboard with synthetic ivory keytops and Linear Graded Hammer

The CLP-480 features a keyboard that has the feel of real ivory. The key surface is soft and slightly porous, giving the keys added grip and a natural friction that lets you play easily. The special Natural Wood keyboard uses real-wood white keys just as an actual grand piano. Moreover, Linear Graded Hammer features the lower keys are heavy in touch and the higher keys are light, with all the natural gradations in between. The CLP-480 provides the performance functions and expressive power found only on grand pianos, such as having repeated plays of the same note perfectly articulated, even when playing at high speed or with partial key release.

Tri-Amp System

The instrument has a built-in Tri-Amp System that features separate amplification for each speaker range—high, mid, and low—providing greater clarity and accuracy from each speaker, ensuring optimum volume balance for each octave range, and letting you enjoy richer, more natural, expansive sound.

Audio Playing and Recording from a USB Flash Memory

Audio files (.wav) saved to a USB storage device such as a USB flash memory can be played back on the instrument. Moreover, since you can record your performance as audio data to a USB flash memory device, it is possible to listen to your performance on portable music players, with the data transferred by computer.

Table of Contents

| | |
|----------------------------|---|
| PRECAUTIONS | 4 |
| NOTICE | 6 |
| Included Accessories | 7 |
| About the Manuals | 7 |
| Main Features | 8 |

Introduction

| | |
|--|----|
| Panel Controls and Terminals | 10 |
| Getting Started — Playing the Clavinova as a Piano | 12 |
| Turning the power on | 12 |
| Music rest | 13 |
| Music braces | 14 |
| Adjusting the display contrast — [CONTRAST] | 14 |
| Setting the volume — [MASTER VOLUME] | 14 |
| Using headphones | 15 |
| Realistic soundboard effects — [S. BOARD SPEAKER] | 15 |
| Using the pedals | 16 |
| Using the metronome — METRONOME [ON/OFF] | 17 |
| Touch Response | 17 |
| Introduction to the controls | 18 |
| Maintenance | 19 |

Advanced Functions

| | |
|--|----|
| Playing various musical instrument sounds (Voices) | 20 |
| Selecting Voices | 20 |
| Listening to the Voice Demo Songs | 21 |
| Enhancing and customizing the sound — [BRILLIANCE]/[REVERB]/[CHORUS] | 23 |
| Playing two Voices simultaneously (Dual) | 24 |
| Splitting the keyboard range and playing two different Voices (Split mode) | 25 |
| Playing back Songs | 27 |
| Playing back a Song | 27 |
| Useful playback functions | 30 |
| Playing a one-hand part — Part Cancel function (MIDI Songs) | 31 |
| Repeat function (MIDI Songs) | 32 |
| Recording your performance | 33 |
| Recording method | 33 |
| Recording without specifying the Part (MIDI/Audio data format) | 34 |
| Multi Recording of specific Parts (MIDI data format) | 36 |
| Other recording techniques | 37 |

| | |
|---|----|
| Handling Song files — [FILE/SONG SETTING] | 41 |
| Basic File operation | 42 |
| Deleting files — “Delete” | 43 |
| Renaming files — “Rename” | 43 |
| Copying files — “Copy” | 44 |
| Moving files — “Move” | 45 |
| Making folders in the USB storage device — “MakeFolder” | 45 |
| Formatting a USB storage device — “Format” | 46 |
| Converting a MIDI Song to an Audio Song during playback — “MIDItoAUDIO” | 46 |
| Confirming the amount of free memory area and all memory area on the USB storage device — “DriveProperty” | 47 |
| Automatically selecting a Song when connecting the USB storage device — “SongAutoOpen” | 48 |
| Changing the type of characters on the display — “CharCode” | 48 |
| Connections | 49 |
| Connectors | 49 |
| Connecting a USB storage device | 51 |
| Connecting a computer | 52 |
| Connecting external MIDI devices | 53 |

Detailed Settings

| | |
|--|----|
| Parameter List | 54 |
| Detailed settings for recording and playback — [FILE/SONG SETTING] | 57 |
| Detailed settings for the metronome — METRONOME [SETTING] | 60 |
| Detailed settings for Voices — [VOICE SETTING] | 61 |
| Detailed settings for acoustic effects | 67 |
| Other settings — [FUNCTION] | 68 |

Appendix

| | |
|------------------------------------|----|
| Preset Voice List (Detailed) | 75 |
| Message List | 78 |
| Troubleshooting | 81 |
| Assembling the Clavinova | 82 |
| Specifications | 87 |
| Options | 88 |
| Index | 89 |

Introduction

Panel Controls and Terminals

Control Panel

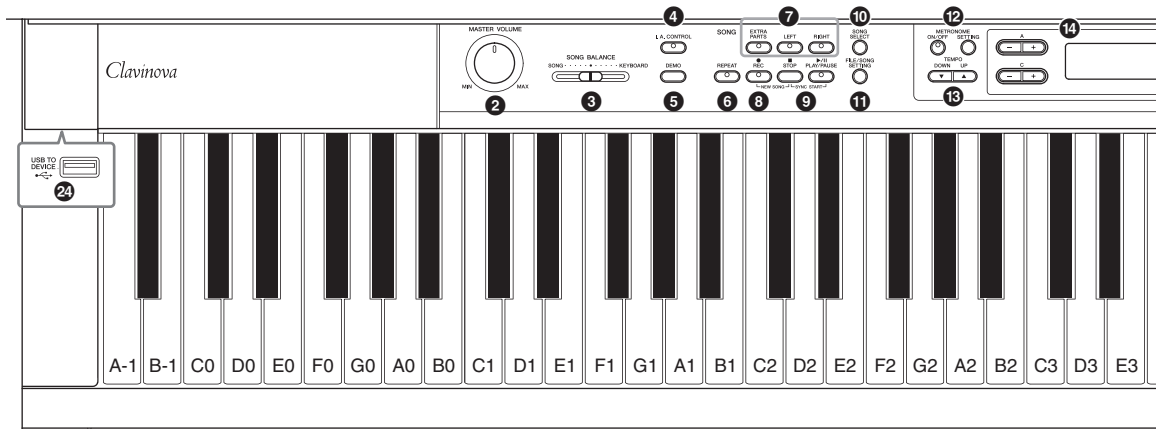

- ❶ [⏻] Power switchpage 13
- ❷ [MASTER VOLUME] dial.....page 14
For adjusting the volume level using this dial.
- ❸ [SONG BALANCE] slider.....page 40
This lets you adjust the volume balance between the Song playback and the sound you are playing on the keyboard.
- ❹ [I. A. CONTROL] button.....page 14
This controls the tonal quality automatically depending on the volume.
- ❺ [DEMO] button.....page 21
Demonstration playback is available for each Voice group.
- ❻ [REPEAT] buttonpage 32
For repeatedly playing back a single Song or specifying a range (in beats) within a Song for repeated playback.
- ❼ [RIGHT], [LEFT], [EXTRA PARTS] buttons pages 31, 36
Turns specific Song parts on or off.
- ❽ [REC] buttonpage 33
For recording your keyboard performance.
- ❾ [PLAY/PAUSE], [STOP] buttonspage 28
For playing back the Preset Songs, your recorded material.
- ❿ [SONG SELECT] button pages 27, 34
For selecting a Song to play back or edit.
- ⓫ [FILE/SONG SETTING] buttonpage 41
For handling Song files. Also lets you make detailed settings for Song recording and playback.
- ⓬ METRONOME [ON/OFF], METRONOME [SETTING] buttons pages 17, 60
For using the metronome functions.
- ⓭ TEMPO [UP] [DOWN] buttons page 17
For changing the tempo (speed) of the Song and metronome.
- ⓮ A – D [-] [+] buttons, Display..... page 18
For selecting an item or setting a value shown at the location corresponding to each of A – D buttons in the display.
- ⓯ [CONTRAST] knob page 14
For adjusting the display contrast.
- ⓰ [EXIT] button page 18
Pressing this button returns to the Voice display (main operation display).
- ⓱ Voice group buttons page 20
For selecting Voices.
- ⓲ [VOICE SETTING] button page 61
For making detailed changes to the Voice sound and effects.
- ⓳ [SPLIT] button page 25
For playing different Voices on the left- and right-hand sections of the keyboard.
- ⓴ [REVERB], [CHORUS] buttons..... page 23
For adding reverb and chorus effects to the sound.
- ⓵ BRILLIANCE [MELLOW] [BRIGHT] buttons page 23
For adjusting the brightness of the sound.
- ⓶ [S. BOARD SPEAKER] button page 15
Turns on or off the effect of GP Sound Board Speaker.
- ⓷ [FUNCTION] button page 68
This lets you make detailed settings, such as adjusting the keyboard touch (Touch Response), making fine adjustments to the pitch or MIDI settings.
- ⓸ [USB TO DEVICE] terminal..... page 51
For connecting the instrument to a USB storage device, allowing you to save the recorded Song to the connected device and play back the Song on the connected device.

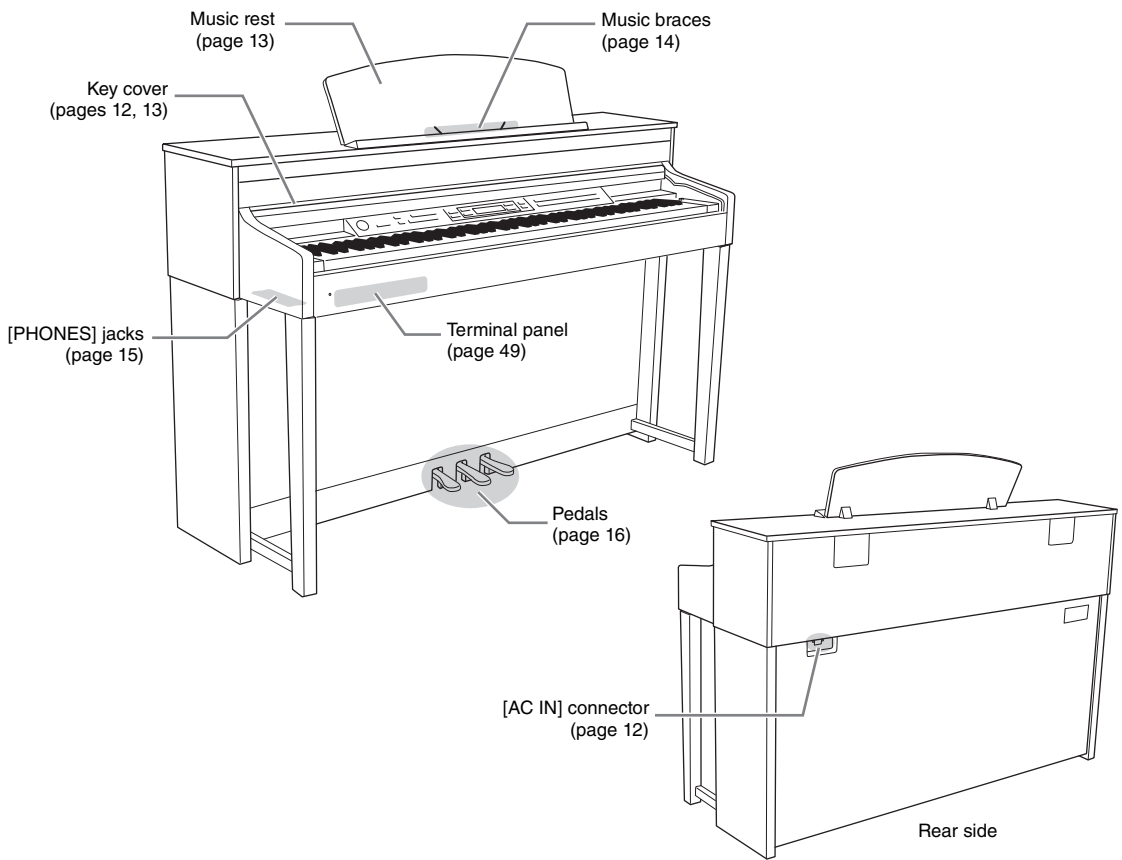
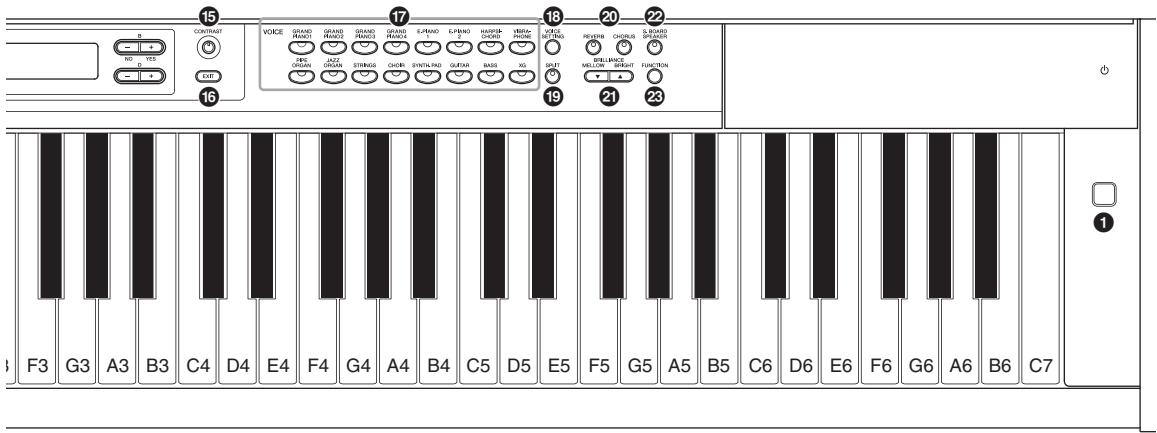

Getting Started — Playing the Clavinova as a Piano

With the full set of pedals and expressive keyboard, this instrument can be played just like a real acoustic piano. This section shows you how to simply set up the instrument and play it. It also shows you how to use the built-in metronome, convenient for practice purposes. We've also included for your piano-playing pleasure "50 greats for the Piano" (Music Book) to help you master the instrument.

Turning the power on

1. Connect the power cable.

First insert the plug of the power cable into the AC connector on this instrument, then plug the other end of the cable into the proper AC outlet on the wall. For an illustration of the location of the [AC IN] connector, see "Panel Controls and Terminals" (page 11). In some areas a plug adaptor may be provided to match the pin configuration of the AC wall outlets in your area.

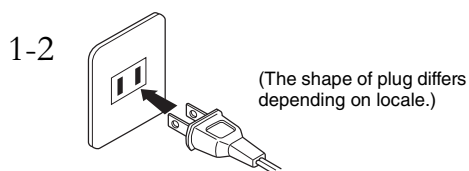
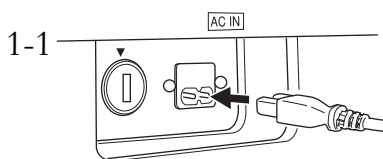

⚠ WARNING

- Make sure your instrument is rated for the AC voltage supplied in the area in which it is to be used (voltage rating appears on the name plate on the bottom panel). In some areas, a voltage selector may be provided on the bottom panel of the main keyboard unit near the AC IN. Make sure that the voltage selector is set for the voltage in your area. Connecting the unit to the wrong AC supply can cause serious damage to the internal circuitry and may even pose a shock hazard!
- Use only the AC power cord supplied with your instrument. If the supplied cord is lost or damaged and needs to be replaced, contact your Yamaha dealer. The use of an inappropriate replacement can pose a fire and shock hazard!
- The type of AC power cord provided with your instrument may be different depending on the country in which it is purchased. (In some areas a plug adaptor may be provided to match the pin configuration of the AC wall outlets in your area.) Do NOT modify the plug provided with your instrument. If the plug will not fit the outlet, have a proper outlet installed by a qualified electrician.

2. Open the key cover.

Lift the cover slightly, then push and slide it to end completely so that both the panel buttons and keyboard are visible. In this condition, you can make various panel operations such as Voice selection and Song recording/playback as well as playing the keyboard.

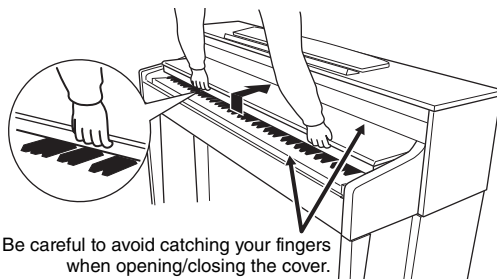

You can open the key cover so that only the keyboard appears. This hides the "electronic" panel controls and lets you feel as if you're playing an actual acoustic piano.

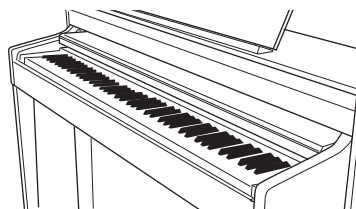

⚠ CAUTION

- Do not place objects such as a piece of metal or paper on top of the key cover. Small objects placed on the key cover may fall inside the unit when the cover is opened and may be nearly impossible to remove. This could cause electric shock, short circuit, fire or other serious damage to the instrument.
- Hold the cover with both hands when opening or closing it. Do not release it until it is fully opened or closed. Be careful to avoid catching fingers (yours or others, especially children's) between the cover and the unit.

NOTICE

Disconnect the optional USB storage device connected to the [USB TO DEVICE] terminal before closing the key cover. Closing the cover with the device still connected may damage the device.

3. Press the [⏻] power switch to turn the power on.

The display located in the center of the front panel and the power indicator located below the left end of the keyboard lights up.

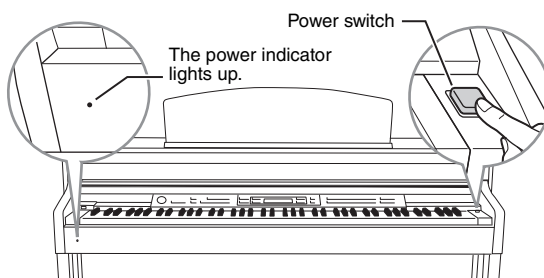

4. Use the [MASTER VOLUME] dial to adjust the volume.

While playing the keyboard, adjust the volume level. For details, refer to “Setting the volume — [MASTER VOLUME]” on page 14.

5. After you use the instrument, press the [⏻] power switch to turn the power off.

The display and the power indicator are turned off.

⚠ CAUTION

Even when the instrument is turned off, electricity is still flowing to the instrument at the minimum level. When you are not using the instrument for a long time or during electrical storms, make sure you unplug the AC power plug from the wall AC outlet.

6. Close the key cover.

Slide the cover toward you and gently lower the cover over the keys.

Music rest

To raise the music rest:

1. Pull the music rest up and toward yourself as far as it will go.
2. Flip down the two metal supports at the left and right on the rear of the music rest.
3. Lower the music rest so that it rests on the metal supports.

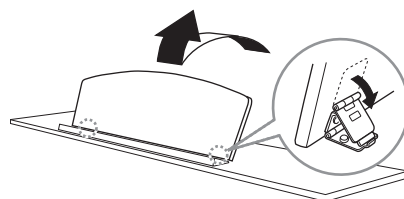

To lower the music rest:

1. Pull the music rest toward yourself as far as it will go.
2. Raise the two metal supports (at the rear of the music rest).
3. Gently lower the music rest backward until it is all the way down.

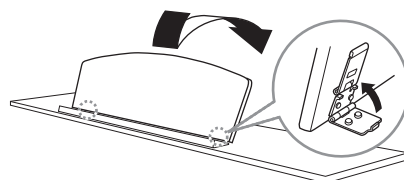

⚠ CAUTION

Do not try to use the music rest in a half-raised position. Also, when raising or lowering the music rest, do not release your hands from the music rest until it is all the way up or down.

Music braces

These braces are for holding the pages of music books in place.

To open

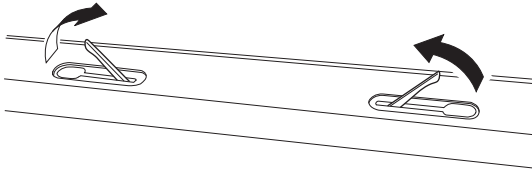

To close

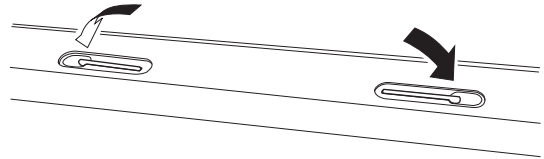

Adjusting the display contrast — [CONTRAST]

You can adjust the contrast of the display by turning the [CONTRAST] knob located to the right of the display.

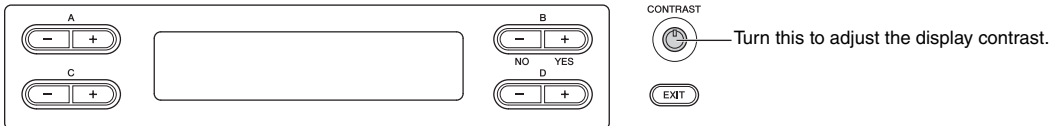

CONTRAST

Difference between brightness and darkness.

Setting the volume — [MASTER VOLUME]

To adjust the volume, use the [MASTER VOLUME] dial located at the left of the panel. Play the keyboard to actually produce sound while you adjust the volume.

MASTER VOLUME:

The volume level of the entire keyboard sound

NOTE

Adjusting the [MASTER VOLUME] dial also affects the output level of the [PHONES] jacks and the output level of the AUX OUT jack.

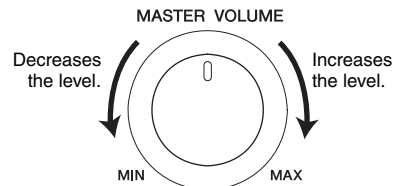

⚠ CAUTION

Do not use the instrument at a high volume level for a long period of time, or your hearing may be damaged.

I.A. Control (Intelligent Acoustic Control)

I.A. Control is a function which automatically adjusts and controls the sound quality according to the overall volume of the instrument. Even when the volume is low, it permits both low sounds and high sounds to be clearly heard.

I. A. CONTROL



Pressing the [I.A. CONTROL] button turns the function on and off.

When it is on, the lamp lights. I.A. Control is effective only from the sound output of the instrument speakers. You can also set the depth of I.A. Control. For details, refer to “Detailed settings for acoustic effects” on page 67.

Using headphones

Connect a pair of headphones to one of the [PHONES] jacks. When the headphones are plugged into either of the [PHONES] jacks, the internal speaker system is automatically shut off. Two [PHONES] jacks are provided. Two sets of standard stereo headphones can be plugged in. (If you are using only one pair of headphones, you can plug them into either of these jacks.)

CAUTION

Do not use headphones at a high volume for an extended period of time. Doing so may cause hearing loss.

Optional headphones

HPE-160 Yamaha headphones

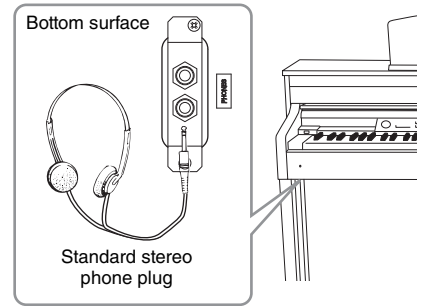

Using the headphone hanger

You can hang the headphones on the instrument. Install the headphone hanger using included two screws (4 × 10mm) as shown in the illustration.

NOTICE

Do not hang anything other than the headphones on the hanger. Otherwise, the instrument or the hanger may be damaged.

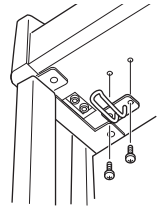

Realistic soundboard effects — [S. BOARD SPEAKER]

This special speaker system, located on the rear side, effectively reproduces the reverberation and spaciousness of the sound of the soundboard on an actual grand piano.



Press the [S. BOARD SPEAKER] button to turn the function on and off.

When it is on, the lamp lights.

To ensure optimum performance of the GP Soundboard Speaker function, place the instrument so that the rear side of the instrument is 1–2 cm away from the wall.

You can also set the depth of GP Soundboard Speaker. For details, refer to “Detailed settings for acoustic effects” on page 67.

Using the pedals

This instrument is equipped with three foot pedals: damper pedal (right), sostenuto pedal (center), and soft pedal (left).

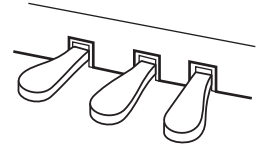

Damper pedal (right pedal)

When you press the damper pedal, the notes you play have a longer sustain. When you select a Grand Piano Voice, pressing the damper pedal activates the instrument's special "Sustain Samples" to accurately recreate the unique resonance of an acoustic grand piano's soundboard and strings. You can set the depth of the Sustain Sampling (page 71).

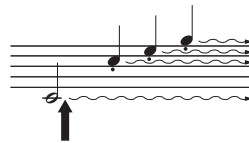

When you press the damper pedal here, the notes you play before you release the pedal have a longer sustain.

NOTE

For details about the Grand Piano Voices to which the Sustain Sampling can be applied, refer to Preset Voice List (detailed) on page 75.

NOTE

You can assign other functions to each pedal by using "RPedalFunc," "CPedalFunc" and "LPedalFunc" in Voice Setting (page 65).

Half-pedal function

This instrument also has a Half-pedal function which allows you to use half-damper techniques, in which the damper is pressed somewhere between all the way down and all the way up. In this half-damper state (on a real piano), the damper felts only partially mute the strings. The Half-pedal function on the Clavinova lets you delicately and expressively control the damper muting, and create subtle nuances in your performance. It also lets you finely control the point at which pressure on the pedal affects the damper muting. (Refer to "Other settings — [FUNCTION]" on page 70.)

GP Responsive Damper Pedal

The damper pedal of this instrument is the GP Responsive Damper Pedal. This special pedal has been designed to provide enhanced tactile response and, when pressed, is much closer in feel to the pedal of an actual grand piano. It makes it easier to physically experience the half-pedal point and more easily apply the half-pedal effect than other pedals. Since the pressing sensation may vary depending on the situation, including the location where the instrument is installed, you should adjust the half-pedal point to the desired setting (page 70).

NOTE

The pedals are covered with vinyl covers when shipped from the factory. For optimum use of the GP Responsive Damper Pedal, we recommend that you remove the cover from the damper pedal.

NOTE

While the sostenuto (center) pedal is held, the Voices in the [PIPE ORGAN], [JAZZ ORGAN], [STRINGS], [CHOIR] and some Voices in the [XG] may sound continuously without decay after the notes have been released.

NOTE

The center pedal or left pedal can be used as equivalent to the [PLAY/PAUSE] button on the panel by setting the "PedalPlay/Pause" parameter (page 70).

Sostenuto pedal (center pedal)

If you play a note or chord on the keyboard and press the sostenuto pedal while holding the note(s), the notes will sustain as long as the pedal is held. All subsequent notes will not sustain.

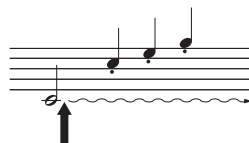

When you press the sostenuto pedal here while holding the note(s), the notes will sustain as long as you hold the pedal.

Soft pedal (left pedal)

The soft pedal reduces the volume and slightly changes the timbre of notes played while the pedal is pressed. The soft pedal will not affect notes that are already playing when it is pressed. When you wish to apply this effect, play notes after pressing the pedal.

Keep in mind that this pedal function will be changed from the Soft pedal depending on the selected Voice. When the Jazz Organ or Mellow Organ is selected, pressing and releasing this pedal switches between "fast" and "slow" of the Rotary Speaker speed ("RotarySpeed" on page 64). When the Vibraphone is selected, this pedal switches between on and off of the Vibrato ("VibeRotorOnOff" on page 64).

Using the metronome — METRONOME [ON/OFF]

The instrument has a built-in metronome (a device that keeps an accurate tempo) that is a convenient tool for practice.

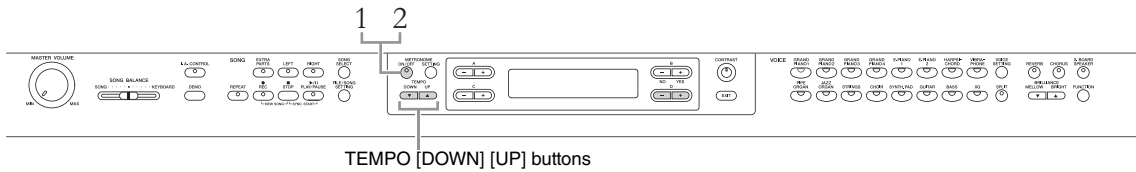

1. Press the **METRONOME [ON/OFF]** button to start the metronome.

Adjusting the tempo

Press the TEMPO [DOWN] or [UP] button to call up the tempo in the display.

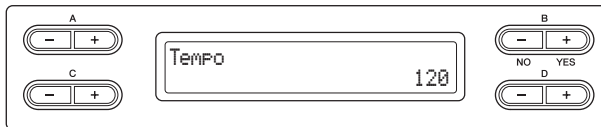

To adjust the tempo (number of beats per minute: 5 – 500), use the TEMPO [DOWN]/[UP] or the D [-]/[+] buttons. To reset the tempo to the default setting (120), press the [DOWN] and [UP] buttons or the D [-] and [+] buttons simultaneously.

Press the [EXIT] button to return to the Voice display.

NOTE

You can set the time signature, metronome volume, and metronome sound using the METRONOME [SETTING] button (page 60).

2. Press the **METRONOME [ON/OFF]** button to stop the metronome.

Touch Response

You can specify the Touch Response (how the sound responds to the way you play the keys). You should adjust this setting according to the specific Voice you're playing or the particular Song you're performing, as desired. For information about how to make settings, refer to "Other settings — [FUNCTION]" on page 68.

Introduction to the controls

This instrument has many buttons and controls — so many that you may feel overwhelmed at first. However, once you understand the basic operations, you'll find the instrument is very easy to use.

Selecting the item/parameter and changing the value

Each function may have many items or parameters from which you can choose. To select an item or parameter, press one of the A [-][+] – D [-][+] buttons. Each parameter in the display corresponds to the A [-][+] – D [-][+] button next to it.

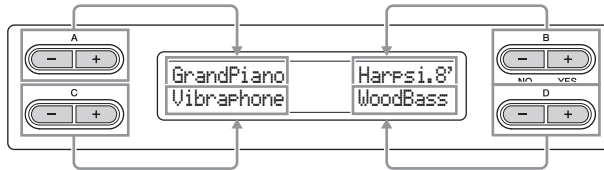

Resetting the value to the default setting

If you've changed the parameter values or settings, you may want to reset them to their default settings. To do this, simply press the [-][+] buttons simultaneously.

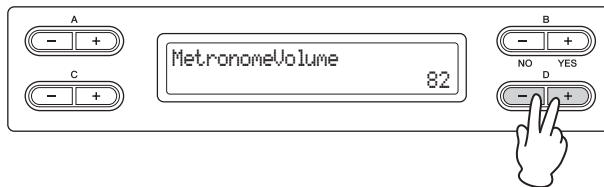

The TEMPO and BRILLIANCE buttons are the same shape as the A [-][+] – D [-][+] buttons. You can reset the related values or parameters by simultaneously pressing buttons of this shape.

Executing or canceling the operation

When a prompt is shown on the upper right of the display, press the B [+ (YES)] / B [- (NO)] button to execute or cancel the operation.

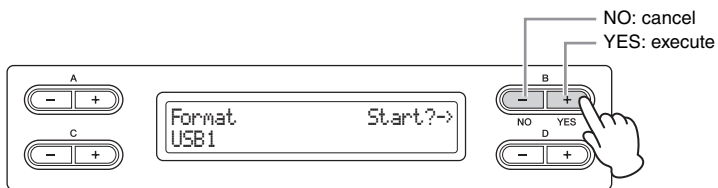

Returning to the Voice display (main operation display)

After you've used a function and want to exit from it, press the [EXIT] button.

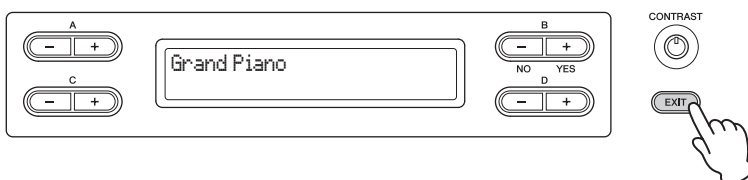

Maintenance

To keep your Clavinova in optimum condition, we recommend that you periodically follow the maintenance points below.

Instrument and Bench Maintenance

- When cleaning the instrument, use a soft, dry or slightly damp cloth.

NOTICE

Do not use paint thinners, solvents, cleaning fluids, or chemical-impregnated wiping cloths.

If you are using a model with a polished finish, gently remove dust and dirt with a soft cloth. Do not wipe too hard since small particles of dirt can scratch the instrument's finish.

To keep the surface polished, apply commercially available piano polisher to a soft cloth and wipe the instrument's surface with it. Then, polish it with a separate cloth. Before using any piano polisher, make sure to read the instructions for proper usage.

- Tighten the screws of the instrument and bench periodically.

Bench Height Adjustment (for applicable benches)

The bench height can be adjusted by rotating the handle. Rotating clockwise heightens the bench. (Before shipment, the handle is firmly fastened.)

Pedal Cleaning

As with an acoustic piano, pedals may become tarnished over years of use. When this occurs, polish the pedal with a compound designed for piano pedals. Before using the compound, make sure to read the instructions for proper usage.

Tuning

Unlike an acoustic piano, the instrument does not need to be tuned. It always stays perfectly in tune.

Transporting

You can transport the instrument along with other belongings. You can move the unit as it is (assembled) or you can disassemble the unit down to the condition it was in when you first took it out of the box. Transport the keyboard horizontally. Do not lean it up against a wall or stand it up on its side. Do not subject the instrument to excessive vibration or shock.

When transporting the assembled instrument, make sure all screws are properly tightened and have not been loosened by moving the instrument.

NOTE

To ensure optimum performance of the GP Soundboard Speaker function, place the instrument so that the rear side of the instrument is 1 – 2 cm away from the wall.

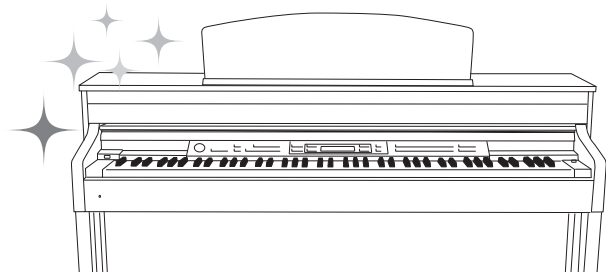

Advanced Functions

Playing various musical instrument sounds (Voices)

In addition to the wonderfully realistic piano sounds, you can select and play other musical instrument sounds (Voices), such as organ or stringed instruments.

Selecting Voices

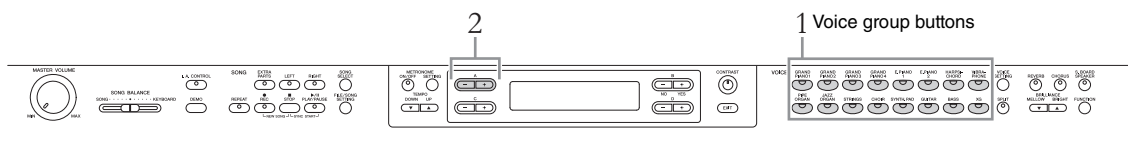

1. Press one of the Voice group buttons to select a Voice group.
 2. Use A [-]/[+] buttons to select a Voice.
- Refer to the Preset Voice list below.
3. Play the keyboard.

NOTE

To learn about the characteristics of the Voices, listen to Demo Songs for each Voice group (page 21). Refer to "Preset Voice List (detailed)" on page 75 for more information on the characteristics of each Preset Voice.

NOTE

Touch Response (page 17) will not be applied to some Voices. For information about Voices to which Touch Response can be applied, refer to "Preset Voice List (detailed)" on page 75.

Preset Voice List

| Voice group | No. | Voice name | Voice group | No. | Voice name |
|--------------|----------|----------------------|-------------|----------|---------------|
| GRAND PIANO1 | 1 | Grand Piano | JAZZ ORGAN | 24 | Jazz Organ |
| | 2 | Ballad Grand | | 25 | Rotary Organ |
| | 3 | Rock Piano | | 26 | Mellow Organ |
| | 4 | HonkyTonk Piano | STRINGS | 27 | Strings |
| GRAND PIANO2 | 5 | Mellow Grand | | 28 | Synth Strings |
| | 6 | Warm Grand | | 29 | Slow Strings |
| GRAND PIANO3 | 7 | Bright Grand | CHOIR | 30 | Choir |
| | 8 | Pop Grand | | 31 | Slow Choir |
| GRAND PIANO4 | 9 | Live Grand | | 32 | Scat |
| | 10 | Dynamic Grand | SYNTH.PAD | 33 | Synth Pad 1 |
| E.PIANO1 | 11 | DX E.Piano | | 34 | Synth Pad 2 |
| | E.PIANO2 | 12 | Synth Piano | GUITAR | 35 |
| 13 | | Stage E.Piano | 36 | | Steel Guitar |
| 14 | | Vintage E.Piano | BASS | 37 | Wood Bass |
| HARPSICHORD | 15 | Harpsichord 8' | | 38 | Bass & Cymbal |
| | 16 | Harpsichord 8'+4' | | 39 | Electric Bass |
| VIBRAPHONE | 17 | Vibraphone | | 40 | Fretless Bass |
| | 18 | Marimba | XG | XG Voice | |
| | 19 | Celesta | | | |
| PIPE ORGAN | 20 | Pipe Organ Principal | | | |
| | 21 | Pipe Organ Tutti | | | |
| | 22 | Pipe Organ Flute 1 | | | |
| | 23 | Pipe Organ Flute 2 | | | |

*For details on XG Voices, refer to the "XG Voice list" (Data List Complete Version which is downloadable from the Yamaha website).

If you select XG in step 1

Because the XG Voice group has an extremely large number of Voices, the group is divided into sub-groups. You can select XG Voices in the conventional way with steps 1 and 2 on page 20; however, if you follow the instructions below, you can select these Voices more efficiently.

1. Press the A [-] and [+] buttons simultaneously so that the current XG Voice group and the current XG Voice are shown in two rows.
2. Use A [-][+] buttons to select the Voice sub-group in the XG Voice group.
3. Use C [-][+] buttons to select the desired Voice.

NOTE

XG is a major enhancement of the GM System level 1 format (page 6), and was developed by Yamaha specially to provide more Voices and variations, as well as greater expressive control over Voices and effects, and to ensure compatibility of data well into the future.

Listening to the Voice Demo Songs

For each Voice group, the instrument contains one Demo Song that showcases the special characteristics of the corresponding Voices.

| Voice group | Title | Composer |
|--------------|--|--------------|
| GRAND PIANO1 | Valse op.34-1 "Valse Brillante" | F. F. Chopin |
| GRAND PIANO2 | Intermezzo, 6 Stücke, op.118-2 | J. Brahms |
| HARPSICHORD | Concerto a cembalo obbligato, 2 violini, viola e continuo No.7, BWV.1058 | J. S. Bach |
| PIPE ORGAN | Herr Christ, der ein'ge Gottes-Sohn, BWV.601 | J. S. Bach |

The demonstration Songs listed above are short rearranged excerpts the original compositions. All other Songs are original (©2011 Yamaha Corporation).

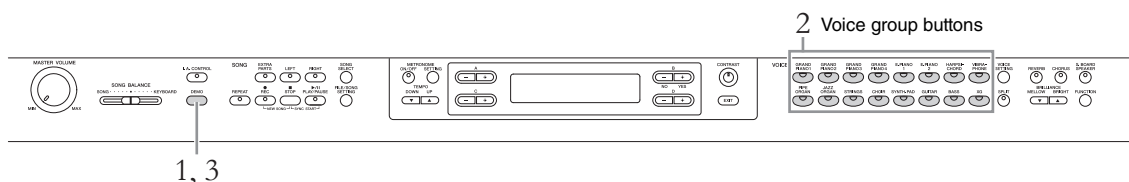

1. Press the [DEMO] button to call up the Demo mode.

The "VoiceDemo" display is shown.

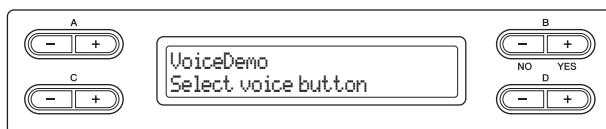

The indicators of the Voice group buttons will flash in succession.

2. Press the desired Voice group button to start playback of the Demo Song.

The Demo Songs will play back consecutively from the upper left Voice group button until you stop the playback.

3. Press the [STOP] button to stop playback.

This operation lets you exit from the Demo mode.

Mode:

A mode is a status under which you can execute a certain function. In Demo mode, you can play back demonstration Songs.

Listening to the Piano Demo (using sampling technology) and GP Soundboard Speaker Demo

1. **Press the [DEMO] button then the A [+] button.**
The “PianoDemo” display is shown.
2. **Press the desired Voice group button to start playback.**
The Piano Demos are assigned to the Voice group buttons as shown in the following table.
3. **Press the [DEMO] button to stop playback.**
You can also stop playback by pressing the [EXIT] or [STOP] button.

| Sampling technology | | Voice group buttons | |
|-----------------------|------------------|---------------------|--------------|
| Piano demo | Stereo Sampling | | GRAND PIANO1 |
| | Mono Sampling | | GRAND PIANO2 |
| | Sustain Sampling | With | GRAND PIANO3 |
| | | No (Without) | GRAND PIANO4 |
| | Key-off Sampling | With | E.PIANO1 |
| | | No (Without) | E.PIANO2 |
| | String Resonance | With | HARPSICHORD |
| | | No (Without) | VIBRAPHONE |
| GP Soundboard Speaker | | With (On) | PIPE ORGAN |
| | | No (Without) | JAZZ ORGAN |

NOTE

For information about the GP Soundboard Speaker, refer to page 15.

NOTE

For explanation about the each sampling and details about the Voices to which the sampling can be applied, refer to Preset Voice List (detailed) on page 75. Refer to page 71 to set the depth of the sampling effect on the Voices.

Enhancing and customizing the sound — [BRILLIANCE]/[REVERB]/[CHORUS]

Three different effects are provided to enhance the sounds of the keyboard. Applying these effects gives you greater and richer expressive capabilities.

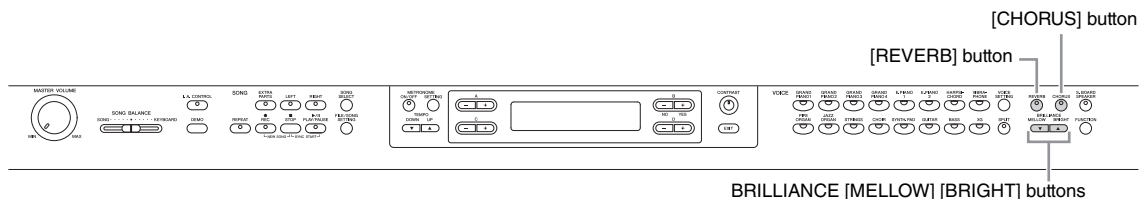

[BRILLIANCE]

You can use this control to adjust the brilliance of the tone. This setting is applied commonly to all Voices.

Press the BRILLIANCE [MELLOW]/[BRIGHT] buttons to select the desired tonality.

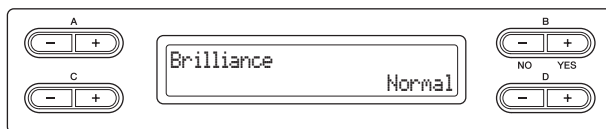

- **Mellow1 – 3**

Soft and mellow tone. The sound becomes more mellow and rounder as the number increases.

- **Normal**

Standard tone.

- **Bright1 – 3**

Bright tone. The sound becomes brighter as the number increases.

Default setting: Normal

NOTE

If you select Bright1 – 3 as the type of brilliance, the volume level will increase slightly. Under this condition, if you raise the [MASTER VOLUME] dial setting, the sound may become distorted. If this happens, lower the volume accordingly.

[REVERB]

This control adds reverberation to the sound by simulating the natural reverberation of a concert hall.

Pressing the [REVERB] button repeatedly toggles the reverb on and off.

Even if the reverb effect is turned off, a “soundboard reverb” effect will be applied when the Voice in the [GRAND PIANO1]–[GRAND PIANO4] is selected.

Default setting: ON

NOTE

You can select a reverb type via the Reverb Type parameter in the “VOICE SETTING” menu, and adjust the reverb depth for the selected Voice via the Reverb Send parameter. (See page 62.)

[CHORUS]

This control adds warmth and spaciousness to the sound.

Pressing the [CHORUS] button repeatedly toggles the chorus on and off.

You can also turn the chorus effect on and off by setting “ChorusOnOff” parameter in Voice Setting on page 63. The [CHORUS] ON/OFF button setting on the panel is temporary. That is, if you select another Voice, the chorus setting for the previous Voice is cancelled. The Chorus On Off parameter setting is saved for each Voice. That is, if you select a given Voice, the chorus setting is automatically turned on or off according to the saved chorus setting.

Default setting:

The default chorus on/off setting is different for each Voice.

NOTE

You can select a chorus type via the Chorus Type parameter in the “VOICE SETTING” menu, and adjust the chorus depth for the selected Voice via the Chorus Send parameter. (See page 63.)

Playing two Voices simultaneously (Dual)

Two Voices can be played simultaneously. You can create warm and richly textured Voices by using Voices from different groups simultaneously in a layer, or by using Voices in the same group.

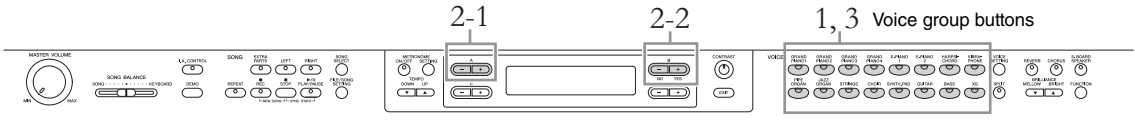

Using Voices in different Voice groups

1. Press two different Voice group buttons simultaneously to enter the Dual mode.

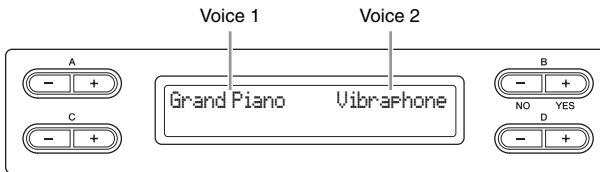

The Voice which is displayed on left side is called Voice 1, and that on the right side is called Voice 2.

2. Select the Voices for layering.
 - 2-1 Use the A [-][+] buttons to select Voice 1.
 - 2-2 Use the B [- (NO)][+ (YES)] buttons to select Voice 2.

After selecting, play the keyboard.
3. To exit from the Dual mode, press any Voice group button.

Using Voices in the same Voice group

1. Press the desired Voice group button.
2. Select the Voices for layering.
 - 2-1 Use the A [-][+] buttons to select Voice 1.
 - 2-2 Press the B [- (NO)] or [+ (YES)] button to enter the Dual mode then use the B [- (NO)][+ (YES)] buttons to select Voice 2.

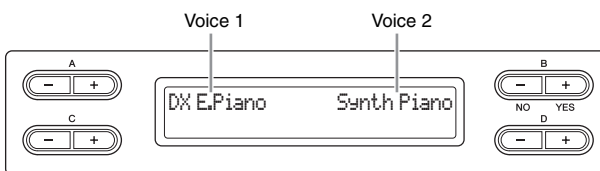

After selecting, play the keyboard.

3. To exit from the Dual mode, press any Voice group button.

Splitting the keyboard range and playing two different Voices (Split mode)

Split mode enables you to play two different Voices on the keyboard — one with the left hand and another with the right hand. For example, you can play a bass part using the Voice in the [BASS] with the left hand, and a melody with the right hand.

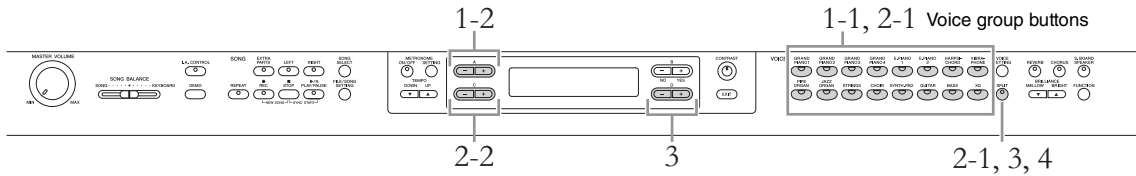

1. Select a Voice for the right-hand area.

1-1 Press the desired Voice group button.

1-2 Use the A [-][+] buttons to select a Voice.

2. Enter the Split mode to select a Voice for the left-hand area.

2-1 Hold down the [SPLIT] button, and press one of the Voice group buttons to select the Voice group for the left-hand area.

2-2 Use the C [-][+] buttons to select the left-hand Voice.

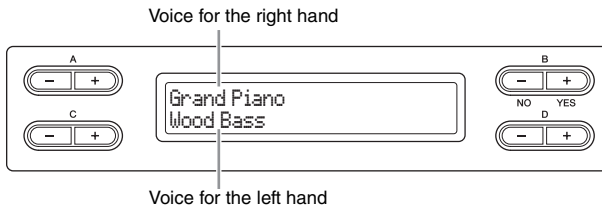

3. Hold down the [SPLIT] button, then use the D [-][+] buttons to specify the split point (the border between the right- and left-hand range).

Alternatively, hold down the [SPLIT] button and press the key you wish to assign as the split point.

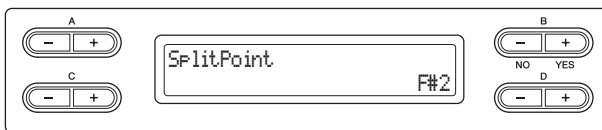

The default setting of the split point is "F#2."

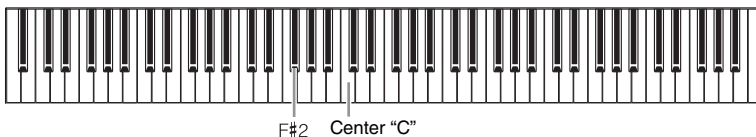

After setting, play the keyboard.

4. Press the [SPLIT] button to exit from the Split mode.

NOTE

A specified "split point" key is included in the left-hand range.

NOTE

The split point can also be set by the [FUNCTION] parameter "SplitPoint" (page 70).

Using Dual and Split simultaneously

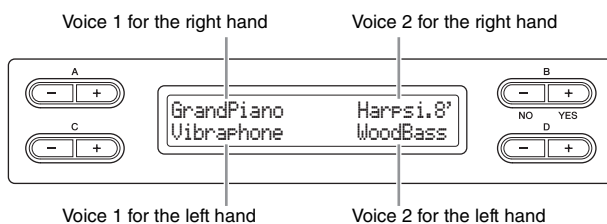

Select a Voice(s) for the right-hand area

When not using Dual (Voice 1 for the right-hand area)

For information on selecting a Voice, see page 20.

When using Dual (Voice 1 and 2 for the right-hand area)

For information on selecting Voices, see page 24.

Select a Voice(s) for the left-hand area

When not using Dual (Voice 1 for the left-hand area)

1. Hold down the [SPLIT] button, and press one of the Voice group buttons to select the Voice group for the left-hand area.
2. Use the C [-][+] buttons to select the left-hand Voice.

When using Dual (Voice 1 and 2 for the left-hand area)

• Using Voices in different Voice groups

1. Hold down the [SPLIT] button, press two different Voice group buttons simultaneously to enter the Dual mode.
2. Select the Voices for layering.
 - 2-1 Use the C [-][+] buttons to select Voice 1.
 - 2-2 Use the D [- (NO)][+ (YES)] buttons to select Voice 2.

• Using Voices in the same Voice group

1. Hold down the [SPLIT] button, and press the desired Voice group button.
2. Select the Voices for layering.
 - 2-1 Use the C [-][+] buttons to select Voice 1.
 - 2-2 Press the D [- (NO)] or [+ (YES)] button to enter the Dual mode then use the D [- (NO)][+ (YES)] buttons to select Voice 2.

Press the [SPLIT] button to exit from the Split mode, or press any Voice group button from the Dual mode.

Playing back Songs

This instrument can play Preset Songs, Songs you recorded on this instrument, or commercially available Songs. In addition to listening to these Songs, you can play the keyboard as the Song plays back.

MIDI Songs and Audio Songs

There are two kinds of Songs that can be recorded and played back on this instrument: MIDI Songs and Audio Songs.

A MIDI Song is comprised of your keyboard performance information and is not a recording of the actual sound itself. The performance information refers to which keys are played, at what timing, and at what strength—just as in a musical score. Based on the recorded performance information, the tone generator (of the Clavinova, etc.) outputs the corresponding sound. A MIDI Song uses a small amount of data capacity in comparison to audio song, and allows you to easily change aspects of the sound, such as Voices used, etc.

An Audio Song is a recording of the performed sound itself. This data is recorded in the same way as that used in recording cassette tapes, or with voice recorders, etc. This data can be played with a portable music player, etc., allowing you to easily let other people hear your performance.

For a general overview of MIDI and how you can effectively use it, refer to “MIDI Basics” (downloadable from the Yamaha website).

You can play back the following types of Songs in this instrument.

- Preset Songs (50 Piano Preset Songs)
- Your own recorded Songs (see page 33 for instructions on recording)
- Commercially available MIDI Song data: SMF (Standard MIDI File) or ESEQ
The maximum size for playback on this instrument is approx. 550KB per single MIDI Song.
- Commercially available Audio Song data: WAV (file extension = .wav with 44.1 kHz sample rate, 16 bit resolution, stereo, and maximum 80 minutes length)

NOTE

For information on compatible data formats, refer to page 6.

Playing back a Song

If you wish to play back the Song in a USB storage device, read “Connecting a USB storage device” (page 51), then connect a USB storage device to the [USB TO DEVICE] terminal.

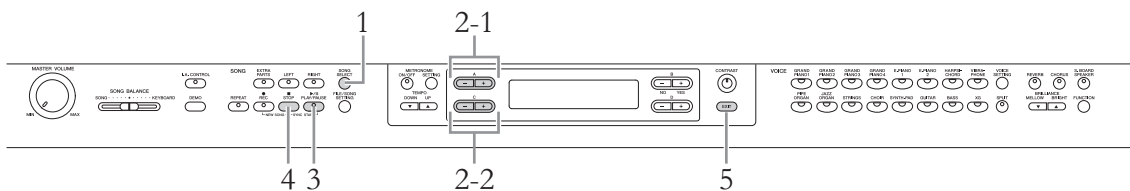

1. Press the [SONG SELECT] button to enter the Song mode.
2. Select a Song to be played back.
 - 2-1 Use the A [-][+] buttons to select a drive (data location).

NOTE

Change the instrument's character type “CharCode” as appropriate for the selected Song (page 48).

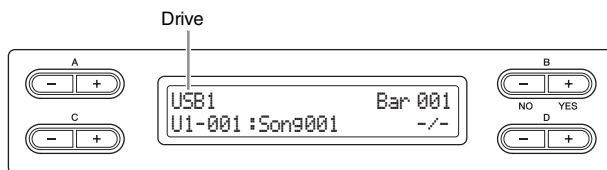

Drives (data location)

• PRESET

You can select the Preset Songs (50 Piano Preset Songs). You can also refer to the included “50 greats for the Piano” (Music Book) that contains the scores.

• MEMORY

You can select your own recorded MIDI Songs on this instrument as well as MIDI Songs copied from the USB storage device to this instrument.

• USB1

This appears only when USB storage device(s) is connected to the [USB TO DEVICE] terminal. You can select the MIDI Songs in the USB storage device. The indications USB1, USB2, etc. will be displayed depending on the number of the connected devices.

• USB AUDIO

This appears only when USB storage device(s) is connected to the [USB TO DEVICE] terminal. You can select the Audio Songs in the USB storage device (USB1).

2-2 Use the C [-]/[+] buttons to select a Song or folder.

If a Song is selected, the Song type and number are shown to the left of the colon while the Song name is shown to the right. If a folder is selected, “FLD” is shown to the left of the colon while the folder name is shown to the right.

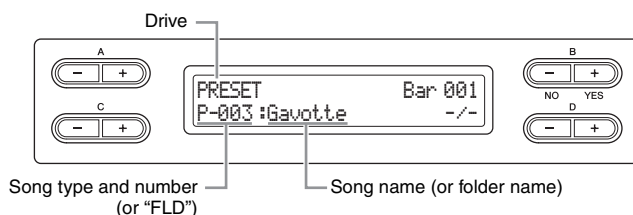

For information about the letter prefixes in the Song number indicating the Song types, refer to page 41.

3. Press the [PLAY/PAUSE] button to start playback.

MIDI Song playback display

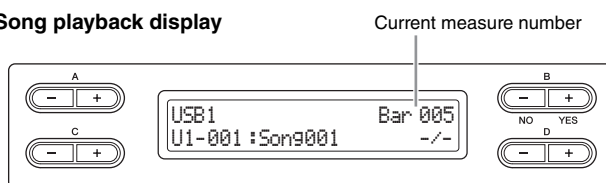

Audio Song playback display

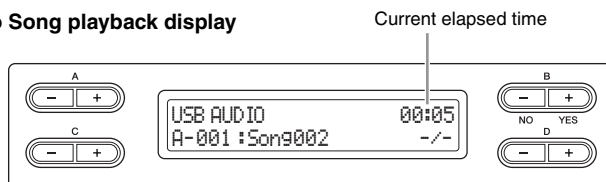

You can play the keyboard along with Song playback. You can also change the Voice for your keyboard performance. To adjust the volume balance between your keyboard performance and Song playback, use the [SONG BALANCE] slider (page 40).

NOTE

If a Song or folder name is too long to be shown at one time, press the [SONG SELECT] button to show the entire name (up to 46 one-byte characters) at one time. To select a Song easier or more smoothly, it is a good idea to shorten the Song name on a computer beforehand.

NOTE

The “↑” and “↓” indicators may be displayed in the lower right of the screen. In this case, you can use the D [+] button to open the folder. Press the D [-] button to shift to the upper level.

NOTE

“----”: New Song” is a blank Song file provided for you to record your performance (page 34).

NOTE

If a Song has been selected, the Song tempo is used. The setting of “Using the metronome” (page 17) will be ignored.

NOTE

Useful playback functions are described on page 30.

NOTE

The metronome can be used during playback. The metronome will automatically stop when playback is stopped.

Pause

Pressing the [PLAY/PAUSE] button will stop playback at the current position. Pressing the [PLAY/PAUSE] button again will start playback from that position. While playback is being paused, the measure number or elapsed time at right corner of the display will flash.

Rewind/Fast forward

Pressing the B [- (NO)] or [+ (YES)] button will move back or forth through the bars during playback or while playback is paused. During playback, press the C [-] button to start playback of the previous Song, and press the C [+] button to start playback of the next Song.

Tempo control (MIDI Songs)

Press the TEMPO [DOWN]/[UP] buttons to adjust the playback tempo of the MIDI Songs. The original tempo of the current Song can be recalled by pressing the [DOWN] and [UP] buttons simultaneously. Press the [SONG SELECT] button to return to the song selection display.

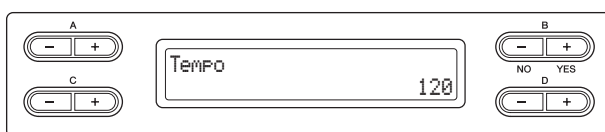

4. Stop playback.

Press the [STOP] button to stop playback.

Even if you don't press the [STOP] button, the Song stops automatically when Song playback reaches the end.

5. Press the [EXIT] button to exit from the Song mode.

Useful playback functions

This section introduces additional playback functions useful for practice and playing.

Playing a one-hand part — Part Cancel function (MIDI Songs)

You can practice the left hand part by playing back only the RIGHT part while you can practice the right hand part by playing back only the LEFT part. Refer to page 31 for the instructions.

Repeat function (MIDI Songs)

With this function, a single entire Song or a specified range of the current Song can be played back repeatedly. It is a good idea to use this function and the Part Cancel function (above) for practicing difficult phrases. Refer to page 32 for instructions.

Starting playback automatically as soon as you play the keyboard

In the special mode called “Sync Start,” pressing any note of the keyboard will start Song playback. To call up the Sync Start mode, select a song and then press the [PLAY/PAUSE] button while holding down the [STOP] button. The [PLAY/PAUSE] lamp will flash at the current tempo. (Press the [STOP] button to disengage the Sync Start mode.)

Playback will then start as soon as you begin playing the keyboard.

Starting/pausing playback by using a pedal

You can assign the Song Play/Pause function (equivalent to the [PLAY/PAUSE] button) to the center or the left pedal in the Function mode (page 70). This is convenient for starting or pausing playback when you are performing and can't take your hands from the keyboard.

Playing Back an Audio Song Repeatedly

It is possible to play a single entire Song repeatedly; however, designating and repeatedly playing back a specific range in a Song cannot be done. For instructions on playing a Song repeatedly, see “SongRepeat” in File/Song Setting on page 57.

Playing a one-hand part — Part Cancel function (MIDI Songs)

Some MIDI Songs such as Preset Songs are divided into the right hand and left hand parts. By using such Song data, you can practice the left hand by turning on only the right hand part, and practice the right hand by turning on only the left hand part — allowing you to practice parts separately for easy mastery of difficult material.

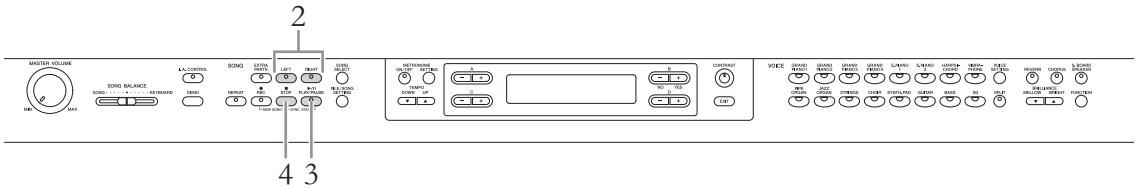

1. Select a Song to be practiced.

For information on selecting a Song, see page 27.

2. Press the [RIGHT] or [LEFT] button to turn off the corresponding part.

Both the [RIGHT] and [LEFT] lamps light when the Song is selected. Turn off the desired part (you want to practice). Pressing each button will switch playback status between on and off.

3. Press the [PLAY/PAUSE] button to start playback.

Play and practice the part you just turned off while listening to the playback part as a guide.

4. Stop playback.

Press the [STOP] button to stop playback. Even if you don't press the [STOP] button, the Song stops automatically when Song playback reaches the end.

NOTE

The parts can be turned on or off even during playback.

NOTE

Usually, Channel 1 is assigned to the [RIGHT] button, Channel 2 is assigned to the [LEFT] button, and Channels 3 – 16 are assigned to the [EXTRA PARTS] button. However, the assignments may differ depending on the particular Song. Try pressing other buttons, when the target part's on and off does not change, even when you press the proper button.

NOTE

Whenever you select another MIDI Song, both parts are automatically turned on.

Repeat function (MIDI Songs)

You can play a single entire Song or a specified range of the current Song can be played back repeatedly. This is convenient for repeatedly practicing difficult phrases.

Playing back a Song repeatedly

1. Select a Song.

For information on selecting a Song, see page 27.

2. Press the [REPEAT] button to turn on the Repeat function.

The [REPEAT] lamp flashes.

3. Press the [PLAY/PAUSE] button to start Repeat playback.

4. Press the [STOP] button to stop playback, then press the [REPEAT] button to turn off the Repeat function.

The [REPEAT] lamp is turned off.

Selecting another MIDI Song automatically turns off the Repeat function.

NOTE

You can also play back a Song repeatedly by setting the "SongRepeat" parameter in File/Song Setting on page 57.

Specifying a range of measures and playing them back repeatedly (A-B Repeat)

1. Select a Song.

For information on selecting a Song, see page 27.

2. Press the [PLAY/PAUSE] button to start playback.

3. Specify the repeat range.

3-1 Press the [REPEAT] button at the Starting point (A) of the range to be repeated.

3-2 Press the [REPEAT] button again at the Ending point (B).

After an automatic lead-in (to help guide you into the phrase), the range from point A to point B is played back repeatedly.

4. Press the [STOP] button to stop playback, then press the [REPEAT] button to turn off the Repeat function.

The [REPEAT] lamp is turned off.

Selecting another MIDI Song automatically turns off the Repeat function.

Specifying the top of a Song as point A

Press the [REPEAT] button, start playback, then press the [REPEAT] button again to specify point B.

Specifying the end of a Song as point B

Specifying only the point A results in repeat playback between the point A and the Song end (as the point B).

Recording your performance

This instrument allows you to record your performance in the following two data formats.

MIDI data format

Recorded performances are saved as an SMF (format 0) MIDI Song. Two types of recording methods are available: Recording without specifying the Part, and Multi Recording, which lets you record specific Parts. You can also re-record only the specified range in case your performance was not satisfactory, or even change the Voice or tempo. The maximum size for recording on this instrument is approx. 550KB per single MIDI Song.

Audio data format

Recorded performances are saved as Audio Songs. Recording is done without specifying the recorded part. Since it is saved in stereo WAV format of normal CD-quality resolution (44.1 kHz/16 bit), it can be transmitted to and played on portable music players by using a computer. This instrument's recordable time is up to 80 minutes per single Audio recording.

If you wish to record on a USB storage device, read "Connecting a USB storage device" (page 51) then follow the instructions below after connecting the USB storage device to the [USB TO DEVICE] terminal.

For details about the difference between MIDI Songs and Audio Songs, refer to page 27.

Recording method

As described above, two methods are available.

Recording without specifying the Part (MIDI/Audio data format)

..... page 34

With MIDI data format recording, the performance will be recorded to Part 1.

Multi Recording of specific Parts (MIDI data format) page 36

This lets you record the right, left and extra parts separately. Since you can record the left part while playing back the right, this is useful for recording both parts of a duet. Since you can record up to sixteen parts separately, record the performance of each instrument part one by one and create fully orchestrated compositions.

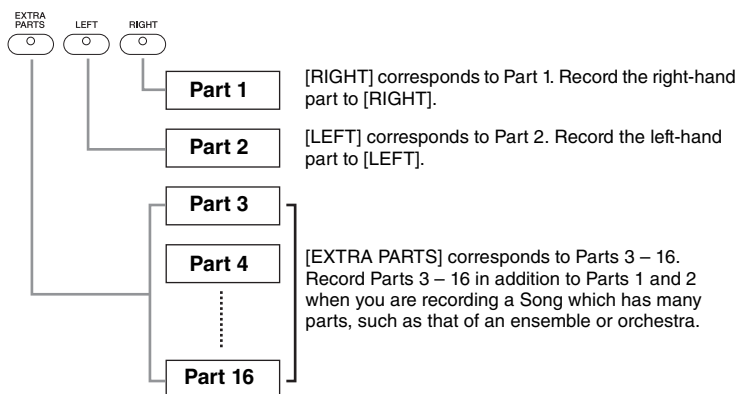

NOTE

(For Multi Recording)
Depending on the Song, such as commercially available Song data, Part assignment to each button may be different from the illustration shown at left.

Refer to the following table concerning the relation between data format, recording method, and recording destination (Drive).

| | | Recording Method | |
|-------------|------------|---------------------------------------|-----------------------------------|
| | | Recording without specifying the Part | Multi Recording of specific Parts |
| Data format | MIDI Song | Yes | Yes |
| | | Recording destination (Drive) | MEMORY/USB1* |
| | Audio Song | Yes | No |
| | | Recording destination (Drive) | USB AUDIO |

* The Song cannot be recorded to the PRESET drive. The MEMORY drive will be selected automatically even if you try selecting the PRESET drive.

Recording without specifying the Part (MIDI/Audio data format)

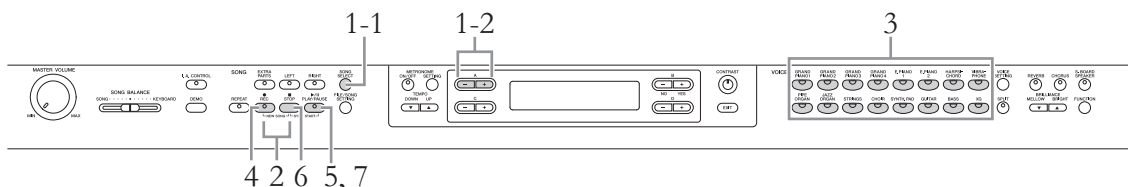

1 Select a Drive as recording destination.

1-1 Press the [SONG SELECT] button.

1-2 Use the A [-]/[+] button to select the Drive as recording destination.

For details about the four Drives, data format and recording method, refer to the table above.

2. Simultaneously press the [REC] and [STOP] buttons to create an empty new Song.

When the MIDI recording (“MEMORY” or “USB1”) is selected in step 1:

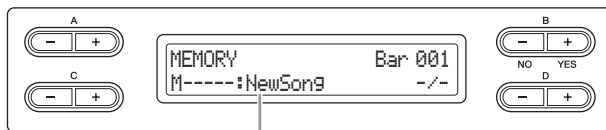

Empty new Song file

When the Audio recording (“USB AUDIO”) is selected in step 1:

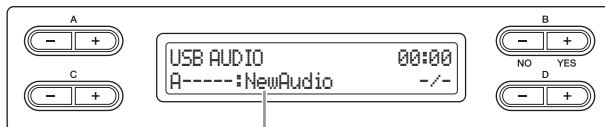

Empty new Song file

NOTICE

If you select a Song other than “New Song” and “New Audio” as recording destination, recording will overwrite and erase the already-recorded data.

3. Select the desired Voice and other parameters, such as time signature, for recording.

For instructions on selecting a Voice, refer to page 20. If necessary, set other parameters, such as time signature and effects, in this step.

4. Press the [REC] button to call up the Record mode.

When MIDI recording (“MEMORY” or “USB1”) is selected in step 1, the [REC], [RIGHT] and [PLAY/PAUSE] lamps flash. When Audio recording (“USB AUDIO”) is selected in step 1, the [REC], [RIGHT], [LEFT], [EXTRA PARTS] and [PLAY/PAUSE] lamps flash. In both cases, the [PLAY/PAUSE] lamp flashes according to the current tempo.

(To exit from this status, press the [REC] or [STOP] button again.)

When MIDI recording (“MEMORY” or “USB1”) is selected in step 1:

Record standby display

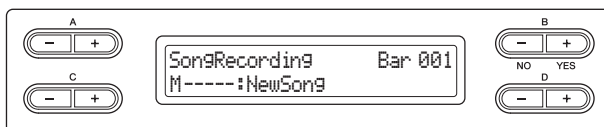

When Audio recording (“USB AUDIO”) is selected in step 1:

Record standby display



5. Start recording.

When MIDI recording (“MEMORY” or “USB1”) is selected in step 1:

Recording begins automatically as soon as you play a note on the keyboard.

When you wish to record an empty section at the start of the Song, press the [PLAY/PAUSE] button to start recording. While recording, the current measure number is shown.

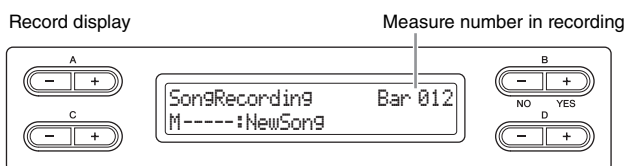

When Audio recording (“USB AUDIO”) is selected in step 1:

Press the [PLAY/PAUSE] button to start recording. While recording, the elapsed time is shown.

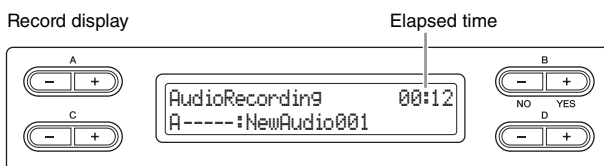

6. Press the [STOP] button to stop recording.

This operation lets you exit from the Record mode then the Song is automatically saved to a destination Song created in step 2. When Save is completed, the display returns to the song selection display.

NOTE

The Song Balance will not be recorded.

NOTE

With MIDI data format recording, the performance will be recorded to Part 1. However, in the Dual/Split mode, the parts assigned for recording and the parts actually used for recording are different. Refer to page 40 for details.

NOTE

You can use the metronome while recording although the metronome sound will not be recorded.

NOTE

The lamp of a Part with data is lit in green. The lamp indications and the data status are as follows.

On (green): Contains data
Flashing (red): Part is enabled for recording
Off: Contains no data

NOTE

To stop recording in the middle of a MIDI Song, press the [PLAY/PAUSE] button. To resume recording, press the [PLAY/PAUSE] button again or play a note on the keyboard.

NOTE

With Audio recording, audio signals via the AUX In jack are also recorded.

NOTE

With Audio recording, distorted sound may be produced if the Voice Volume (page 61) is set to the value higher than the default setting. Make sure to set the Voice Volume to the default value or less before recording. Pressing the D [-] and [+] buttons simultaneously will restore the default value.

NOTE

If a “Device (media) busy” message appears on the display during Audio recording, the operation will end automatically and the recording data before the end is saved. When such a case occurs, format the USB storage device then try the recording operation again. For details about the Format, refer to page 46.

NOTE

The recorded Songs are named automatically, but you can rename Songs as you like (page 43).

- Press the [PLAY/PAUSE] button to play back the recorded Song.

Multi Recording of specific Parts (MIDI data format)

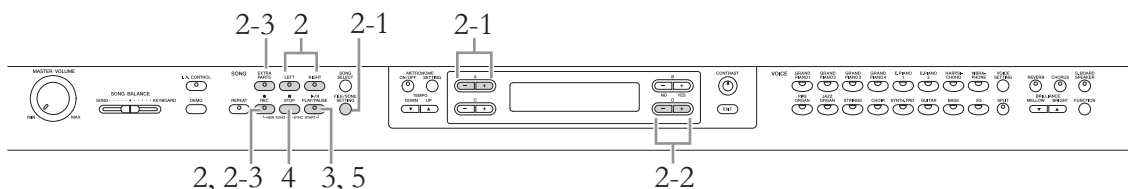

- Make the necessary settings by following steps 1 – 3 in “Recording without specifying the Part” (page 34).
- Specify the recording part and call up the Record mode.

When recording to the right (Part 1) or left (Part 2) part:

Hold down the [REC] button and press the [RIGHT] or [LEFT] button.

When recording to the extra parts (Parts 3 – 16):

2-1 Press the [FILE/SONG SETTING] button and press the A [-]/[+] button to display “RecExtraPartsCh.”

2-2 Press the D [-]/[+] buttons to specify a recording part.
The specified part is assigned to the [EXTRA PARTS] button.

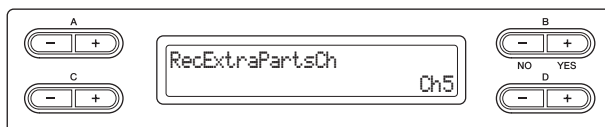

2-3 Hold down the [REC] button and press the [EXTRA PARTS] button.

With the above operations, the [REC] lamp and specified part lamp flash in red. (To exit from this status, press the [REC] button again or press the [STOP] button.)

Record Standby display

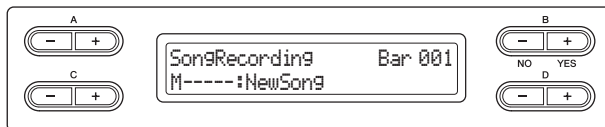

- Play the keyboard or press the [PLAY/PAUSE] button to start recording.
- Press the [STOP] button to stop recording.

This operation exits from the Record mode and automatically saves the recorded data to a destination Song. When Save is completed, the display returns to the song selection display.

NOTE

See page 40 for information on recording in the Dual/Split mode.

5. Press the [PLAY/PAUSE] button to play back the recorded Song.

After recording is completed, specify a different recording part in Step 2, then record and overdub onto your performance as desired, part by part.

NOTE

The recorded Songs are named automatically, but you can rename Songs as you like (page 43).

Other recording techniques

Replacing the part of an existing Song (MIDI data format)

For example, you can record your performance to the Right part along with the Left part playback of the existing Song.

1. Select the desired existing Song.

For information on selecting a Song, see page 27.

2. If necessary, select the settings (Voice and other parameters).

Select the desired settings, if you wish to change the previous ones.

3. Select a Part, start recording then stop recording by executing steps 2 – 4 of “Multi Recording of specific Parts” on page 36.

When you select a Preset Song in step 1, the recorded Song will be automatically saved as a new Song to the MEMORY drive. When you select a Song in the MEMORY drive/USB storage device in step 1, the recorded Song will be overwritten.

4. Press the [PLAY/PAUSE] button to play back the recorded Song.

NOTE

The Song Balance will not be recorded.

Re-recording a Song partially (MIDI data format)

You can re-record a specific range of the MIDI Song.

1. Select the desired MIDI Song.

For instructions, refer to page 27.

2. Select a recording method.

2-1 Press the [FILE/SONG SETTING] button.

2-2 Press the A [-][+] buttons to display “RecStart” or “RecEnd.”

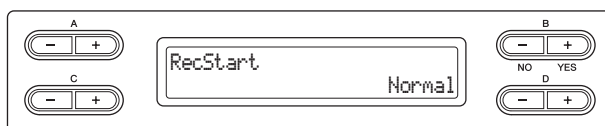

2-3 Press the D [-][+] buttons to specify how the recording should start and end.

Starting methods:

• **Normal:**

The existing data will be erased after re-recording starts.

• **FirstKeyOn:**

Data that exists prior to the point where you start playing a note will remain.

Ending methods:

• **Replace:**

The data after the point you stop recording will also be erased.

• **PunchOut:**

The data after the point you stop recording will remain.

3. Press the [SONG SELECT] button to return to the song selection display.

4. Specify the start point you wish to re-record.

Use the B [- (NO)][+ (YES)] buttons to move the Song measure, or press the [PLAY/PAUSE] button to start playback then press the [PLAY/PAUSE] button again slightly prior to the desired point.

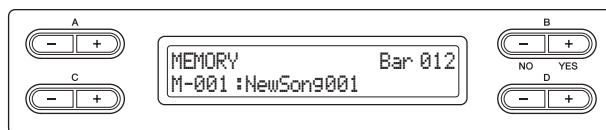

5. If necessary, select the settings (Voice and other parameters).

Select the desired settings, if you wish to change the previous ones.

6. Call up the Record mode.

When you specify the recording part:

Follow step 2 on page 36.

When you do not specify the recording part:

Press the [REC] button.

7. Play the keyboard or press the [PLAY/PAUSE] button to start recording.

8. Press the [STOP] button to stop recording.

9. Press the B [+ (YES)] to overwrite your performance.

To cancel the Overwrite operation, press the B [- (NO)] button.

10. Press the [PLAY/PAUSE] button to play back the recorded Song.

11. Press the [EXIT] button to exit from the Record mode.

NOTE

The Song Balance will not be recorded.

NOTE

The time signature cannot be changed when replacing the part of an existing Song.

Changing a Voice or the tempo after recording (MIDI data format)

For the MIDI Song, you can change the Voice and tempo after recording to change a feel or to set a more suitable tempo. You can also change these elements in the middle of a Song.

1. Select the Song you wish to change.

For instructions, refer to page 27.

2. Select the settings (Voice and other parameters).

After the setting is completed, press the [SONG SELECT] button to return to the song selection display (in step 1).

NOTICE

The settings made here will be saved to the selected MIDI Song as soon as you execute step 4. Note that this cannot be restored to the previous status.

3. Press the [REC] button then confirm whether or not the desired Part lamp flashes in red.

If not, hold the [REC] button and press the desired Part button so that the corresponding lamp flashes.

4. Press the [STOP] and [REC] buttons simultaneously to actually change the settings as made in step 2.

5. Press the B [+ (YES)] button to overwrite the settings to the MIDI Song selected in step 1.

This operation exits from the Record mode and automatically overwrites the Song. To cancel the Overwrite operation, press the B [- (NO)] button.

6. Press the [PLAY/PAUSE] button to start playback of the changed Song.

NOTE

The time signature cannot be changed.

Data that can be recorded to MIDI Songs

Data for each Part

- Note data (your keyboard performance)
- Voice selection
- Pedal (Damper/Soft/Sostenuto)
- Reverb Send — “ReverbSend”
- Chorus Send — “ChorusSend”
- DSP effect Depth — “DSPDepth”
- Sound brightness — “Brightness”
- Resonance effect setting — “HarmonicContent”
- Octave setting — “Octave”
- Volume setting for each Voice — “Volume”
- Pan for each Voice
- Fine pitch adjustment between two Voices (Dual only) — “Detune”
- Volume change in response to playing strength for each Voice — “TouchSense”

Data commonly for all Parts

- Scale
- Tempo
- Time Signature
- Reverb Type
- Chorus Type
- DSP Effect Type

NOTE

The note data, pedal (Damper/Soft/Sostenuto) data, octave setting and time signature cannot be changed after recording.

Adjusting the volume balance between playback and your performance — [SONG BALANCE]

While recording multiple parts one by one, you can adjust the volume balance between the playback of the recorded parts and your current performance.

1. Move the [SONG BALANCE] slider to the left or right to make adjustments.

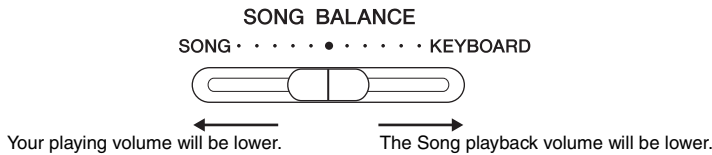

NOTE

The Song Balance will not be recorded.

NOTE

Some commercially-available music data contains extremely high volumes. When using such data, please adjust the Song Balance.

Assigning parts for recording in the Dual and Split mode (MIDI data format)

When you record in the Dual and Split mode, the parts assigned for recording and the parts used for recording are different. Refer to the following table.

NOTICE

When you record multiple parts one by one, or when you record new data over an existing Song, the existing data will be erased. Proceed with caution.

NOTE

Switching between the Dual and Split mode in a Song is not recorded.

NOTE

The buttons actually used for recording ([RIGHT], [LEFT] and [EXTRA PARTS]) are turned on.

In the following example, RIGHT, LEFT, and EXTRA PARTS “n” have been selected for recording.

| Parts assigned for recording | | Dual | | | Split | | | Split + Dual | | |
|------------------------------|----------------|----------------|---------------|------------------------|----------------|---------------|------------------------|----------------|---------------|------------------------|
| | | RIGHT (Part 1) | LEFT (Part 2) | EXTRA PARTS n (Part n) | RIGHT (Part 1) | LEFT (Part 2) | EXTRA PARTS n (Part n) | RIGHT (Part 1) | LEFT (Part 2) | EXTRA PARTS n (Part n) |
| Parts used for recording | MAIN (Voice 1) | Part 1 | Part 2 | Part n | Part 1 | | Part n | Part 1 | Part n | |
| | LEFT (Voice 1) | — | | | Part 2 | | Part n+1 | Part 2 | Part n+1 | |
| | MAIN (Voice 2) | Part 3 | Part 4 | Part n+2 | — | | | Part 3 | Part n+2 | |
| | LEFT (Voice 2) | — | | | — | | | Part 4 | Part n+3 | |

Part n = Part 3 – Part 16

Handling Song files — [FILE/SONG SETTING]

This display, called up via the [FILE/SONG SETTING] button, enables you to apply various operations to Song files — Preset Songs, Songs you recorded on this instrument or commercially available Songs. To connect a USB storage device, be sure to read the section “Precautions when using the [USB TO DEVICE] terminal” on page 51.

| Operation | Indication | Page |
|---|---------------|------|
| Deleting files | Delete | 43 |
| Renaming files | Rename | 43 |
| Copying files* | Copy | 44 |
| Moving files* | Move | 45 |
| Making folders in the USB storage device | MakeFolder | 45 |
| Formatting a USB storage device | Format | 46 |
| Converting a MIDI Song to an Audio Song during playback* | MIDItoAUDIO | 46 |
| Confirming the amount of free memory area and all memory area on the USB storage device | DriveProperty | 47 |
| Automatically selecting a Song when connecting the USB storage device | SongAutoOpen | 48 |
| Changing the type of characters on the display | CharCode | 48 |

File

A file contains a group of data. On this instrument, a Song file includes Song data and a Song number.

The operations marked with a "*" are available only when a MIDI Song is selected.

Song types and limitation of File operations

The letter prefixes and Song number (3-digit) are shown to the left of the Song name. The following chart shows the meaning of each letter indicating the Song type and restrictions on File operations.

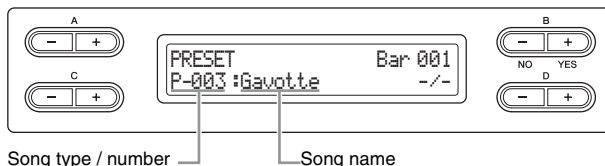

O: Yes, x: No

| Drive (Data Location) | | Song type | Description | Delete | Rename | Copy | Move | MIDI to AUDIO |
|-----------------------|--------------|--|---|--------|--------|-----------------|-----------------|---------------|
| Internal memory | PRESET drive | P-xxx | Preset Songs (MIDI) | x | x | O ^{*1} | x | x |
| | MEMORY drive | M-xxx | MIDI Songs | O | O | O | O | O |
| | | M-xxxP M-xxxS M-xxxx ^{*3} | Preset Songs (MIDI) copied into MEMORY drive or MIDI Songs with protect applied MIDI Songs with Yamaha's proprietary protect applied | O | O | x | x | x |
| USB storage device | USB1 | U1-xxx | MIDI Songs | O | O | O | O | O |
| | | U1-xxxP | MIDI Songs with protect applied | x | x | O ^{*1} | x | x |
| | | U1-xxxS U1-xxxx ^{*4} | MIDI Songs with Yamaha's proprietary protect applied | O | O | x | O ^{*2} | x |
| | USB AUDIO | A-xxx | Audio Songs | O | O | x | x | x |

*1 Available for copying only to the MEMORY drive

*2 Available for moving only between the MEMORY drive and USB storage device

*3 This file should be saved in the same folder as that of "M-xxxS." If not, playback cannot be done.

*4 This file should be saved in the same folder as that of "U1-xxxS." If not, playback cannot be done.

Basic File operation

Song files can be handled via the instructions shown below. If you wish to handle files in a USB storage device, make sure that the USB storage device is properly connected to the [USB TO DEVICE] terminal.

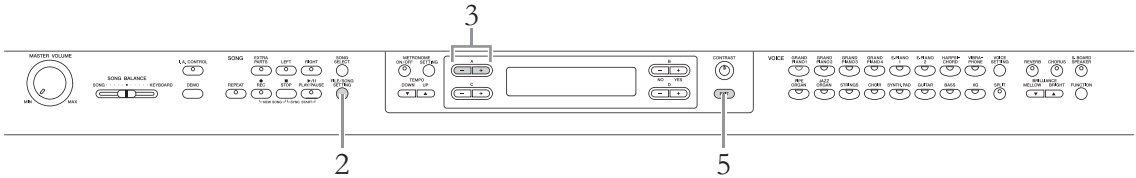

1. Prepare for handling file(s) as follows.

To use “Delete,” “Rename,” “Copy,” “Move” or “MIDItoAUDIO”:

Select a Song for handling. For information on selecting a Song, see page 27.

To use “MakeFolder”:

Select a Song or folder for handling. The folder will be made in the same level as that of the selected Song or folder. For information on selecting a Song, see page 27.

To use “Format,” “DriveProperty,” “SongAutoOpen” or “CharCode”:

No need to perform any operations in this step.

2. Press the [FILE/SONG SETTING] button to access the File mode.

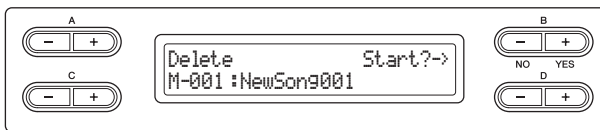

From here, if you wish to close the File mode, press the [EXIT] button once or twice.

3. Press the A [-][+] buttons several times to select the desired operation.

4. Execute the selected operation.

For information about this procedure, refer to the corresponding section on pages 43 – 48.

During operation, messages (information, confirmation, etc.) may be shown on the display. For explanations and details, refer to “Message List” on page 78. Also, see some of the common display messages shown at right.

NOTICE

Do not disconnect the USB Storage Device during file handling or when a USB Storage Device is mounted. Doing so may delete all data in the USB storage device and the instrument.

5. Press the [EXIT] button to close the File mode.

NOTE

The “↑” and “↓” indicators may be appeared in the lower right of the display. In this case, you can use the D [+] button to open the folder. Press the D [-] button to shift to the upper level.

Display messages

“Start?->”:

Do you wish to start the operation?

“Overwrite?->”:

Do you wish to overwrite the Song?

“Execute?->”:

Do you wish to execute the operation?

“Sure?->”:

Are you sure?

“Executing”:

The instrument is executing the operation.

“Completed”:

The operation is complete.

Deleting files — “Delete”

For details about Song types which can be deleted, refer to page 41.

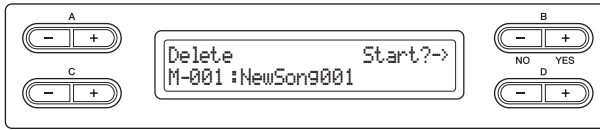

See page 42 for information on basic operations.
The following is a detailed procedure of Step 4 on that page.

Press the B [+ (YES)] button located next to “Start?->” then follow the on-screen instructions.

NOTICE

Do not turn off the power or eject the USB storage device while “Executing” is shown in the display.

NOTE

Only empty folders containing no files can be deleted; folders containing a file or files cannot be deleted.

NOTE

The Song numbers following the deleted Song will be moved forward by one (to smaller numbers).

Renaming files — “Rename”

For details about Song types which can be renamed, refer to page 41.

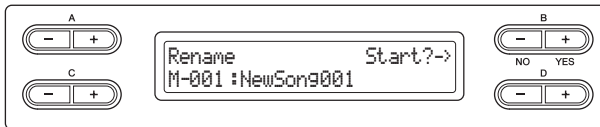

See page 42 for information on basic operations.
The following is a detailed procedure of Step 4 on that page.

4-1 Press the B [+ (YES)] button located next to “Start?->”

4-2 Assign the name to the Song.

Use the C [-]/[+] buttons to move the cursor (underline). Pressing both the buttons simultaneously will insert the space.

Use the D [-]/[+] buttons to change the character at the current cursor position. Pressing both the buttons simultaneously will delete the character at the current cursor position.

The Song name can contain up to 46 characters. The characters which exceed the display capacity and invisible can be called up by moving the cursor via the C [-]/[+] buttons.

4-3 Press the B [+ (YES)] button located next to “Name?->” then follow the on-screen instructions.

After you rename a Song, this instrument sorts Songs alphabetically and renumbers them.

NOTICE

Do not turn off the power or disconnect the USB storage device while “Executing” is shown in the display.

NOTE

To rename a folder, select the desired folder in step 1 on page 42. The folder name can contain up to 50 characters.

NOTE

For information about the character type available for the Song name, refer to “Changing the type of characters in display — CharacterCode” on page 48.

Copying files — “Copy”

For details about Song types which can be copied, refer to page 41.

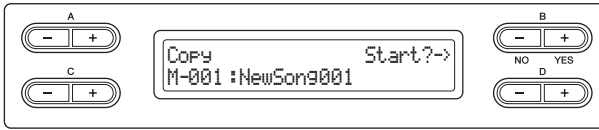

Range of the Copy/Move operation

You can copy a Song file from the internal MEMORY drive to the external USB storage device and vice versa.

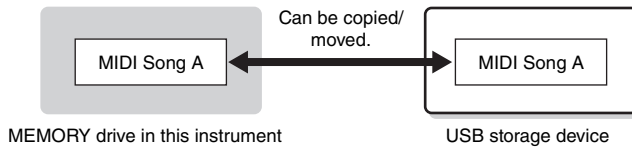

In the USB storage device, you can copy a Song file from the current folder to the different folder but not to the same root directory or same folder.

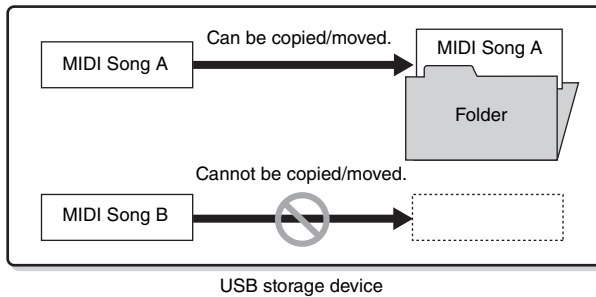

See page 42 for information on basic operations.

The following is a detailed procedure of Step 4 on that page.

- 4-1 Press the B [+ (YES)] button located next to “Start?->”
- 4-2 Use the A [-]/[+] buttons to select a Copy destination.
If you wish to copy a Song to a certain folder, use the C [-]/[+] buttons to select a folder, then press the D [+] button to enter the selected folder.
The selected Song will be copied to the destination specified here.
- 4-3 Press the B [+ (YES)] button to fix the Copy destination then follow the on-screen instructions.

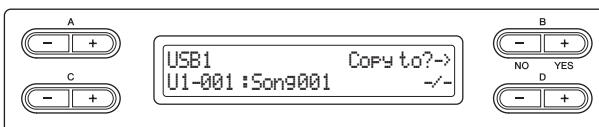

NOTICE

Do not turn off the power or disconnect the USB storage device while “Executing” is shown in the display.

NOTE

Please note that the copy features are intended for your personal use only.

NOTE

The folder cannot be copied.

NOTE

For instructions about the Move operation, refer to page 45.

Root:

The highest level of a hierarchical structure. This indicates an area which does not belong to a folder.

NOTE

To exit from the current folder to the upper level, press the D [-] button.

Moving files — “Move”

For details about Song types which can be moved, refer to page 41.

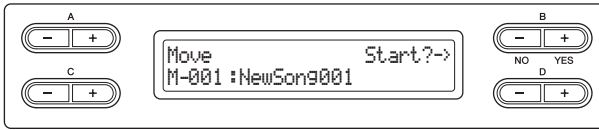

See page 42 for information on basic operations.

The following is a detailed procedure of Step 4 on that page.

4-1 Press the B [+ (YES)] button located next to “Start?->”

4-2 Use the A [-][+] buttons to select a Move destination.

If you wish to move a Song to a certain folder, use the C [-][+] buttons to select a folder, then press the D [+] button to enter the selected folder. The selected Song will be moved to the destination specified here.

4-3 Press the B [+ (YES)] button to fix the Move destination then follow the on-screen instructions.

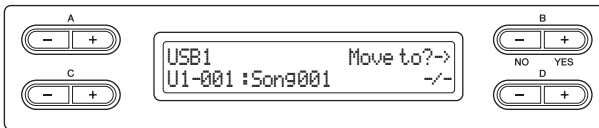

NOTICE

Do not turn off the power or disconnect the USB storage device while “Executing” is shown in the display.

NOTE

The folder cannot be moved.

NOTE

To exit from the current folder to the upper level, press the D [-] button.

Making folders in the USB storage device — “MakeFolder”

You can create folders (directories) on the USB storage device to organize Songs. This instrument enables you to create folders only in the USB storage device — not in the internal MEMORY drive.

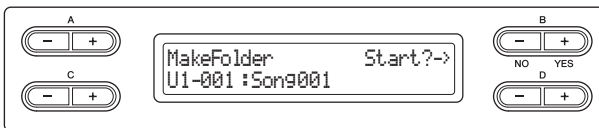

See page 42 for information on basic operations.

The following is a detailed procedure of Step 4 on that page.

4-1 Press the B [+ (YES)] button located next to “Start?->”

4-2 Assign the name to the folder.

For instructions on naming, refer to page 43.

The folder name can contain up to 50 characters. The new folder will be created in the root directory of the USB storage device.

NOTICE

Do not turn off the power or disconnect the USB storage device while “Executing” is shown in the display.

Root:

The highest level of a hierarchical structure. This indicates an area which does not belong to a folder.

Formatting a USB storage device — “Format”

When connecting the USB storage device to the [USB TO DEVICE] terminal or inserting the media to the connected USB device, a message prompting you to execute the Format operation may appear. If such a case occurs, execute the Format operation.

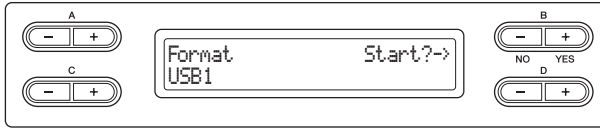

NOTICE

When formatting is done, all data stored in the USB storage device are deleted. Save important data to a computer or another storage device.

See page 42 for information on basic operations.

The following is a detailed procedure of Step 4 on that page.

- 4-1 Press the B [+ (YES)] button located next to “Start?->.”
- 4-2 If the two or more USB devices are connected, use the C [-]/[+] buttons to select a device to be formatted.
Selecting “USB1” will format also the data in “USB AUDIO” which cannot be selected here.
- 4-3 Press the B [+ (YES)] button to fix the Format destination then follow the on-screen instructions.

NOTICE

Do not turn off the power or disconnect the USB storage device while “Executing” is shown in the display.

Converting a MIDI Song to an Audio Song during playback — “MIDItoAUDIO”

The MIDI Song in the MEMORY drive and USB storage device (USB1 drive) can be converted to the Audio Song then saved in the USB storage device (USB AUDIO drive). For information about Song types which can be converted, refer to page 41.

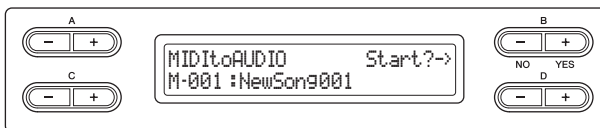

See page 42 for information on basic operations.

The following is a detailed procedure of Step 4 on that page.

- 4-1 Press the B [+ (YES)] button located next to “Start?->.”
- 4-2 If you wish to specify a certain folder as a Convert destination, use the C [-]/[+] buttons to select a folder, then press the D [+] button to enter the selected folder.
The converted Audio Song will be saved in the destination specified here.

NOTE

“USB AUDIO” is the USB storage device equivalent to “USB1.”

NOTE

After converting, the MIDI Song remains in the original data location.

NOTE

To exit from the current folder to the upper level, press the D [-] button.

- 4-3 Press the B [+ (YES)] button to fix the Convert destination then follow the on-screen instructions.

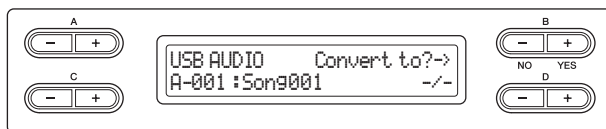

- 4-4 Press the B [+ (YES)] button located next to “Sure?->” to execute the MIDI to AUDIO operation.

This operation starts playback and conversion from MIDI to Audio. After starting playback (conversion), wait until playback ends. This is necessary because the MIDI Song is re-recorded in real time during playback to an Audio Song. This status is equivalent to that of Audio Song Recording, allowing you to record your keyboard performance and audio signals via the AUX IN jack (such as the microphone sound).

When the conversion is completed, “Completed” will appear in the display.

Confirming the amount of free memory area and all memory area on the USB storage device — “DriveProperty”

This function shows the amount of remaining memory and entire memory in the USB storage device.

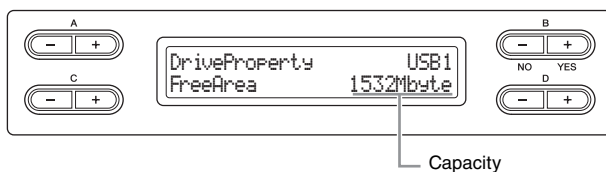

See page 42 for information on basic operations.

The following is a detailed procedure of Step 4 on that page.

- 4-1 If two or more USB devices are connected, use the B [-]/[+] buttons to select the device whose memory capacity you wish to check.

The same amount of memory capacity will be shown when selecting either “USB1” or “USB AUDIO.”

- 4-2 Use the C [-]/[+] buttons to select “FreeArea” or “AllArea.”

FreeArea:

Amount of the remaining memory capacity.

AllArea:

Amount of the entire memory capacity.

Automatically selecting a Song when connecting the USB storage device — “SongAutoOpen”

With this function, the Song saved in the root directory can be selected automatically as soon as the USB storage device is connected.

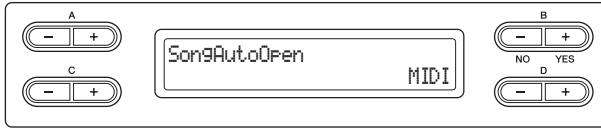

See page 42 for information on basic operations.
The following is a detailed procedure of Step 4 on that page.

4. Use the D [-][+] buttons to select “MIDI,” “AUDIO,” or “Off.”

- When “MIDI” is selected, MIDI Songs in the root directory will be selected.
- When “AUDIO” is selected, Audio Songs in the root directory will be selected.
- When “Off” is selected, no Song in the USB storage device will be selected.

Setting range:
MIDI, AUDIO, Off

Changing the type of characters on the display — “CharacterCode”

You can change the type of characters that appear on display. The default setting is “International.” To input katakana, change this setting to “Japanese.”

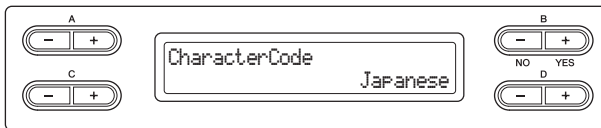

See page 42 for information on basic operations.
The following is a detailed procedure of Step 4 on that page.

4. Use D [-][+] button to select “International” or “Japanese.”

Character list

International

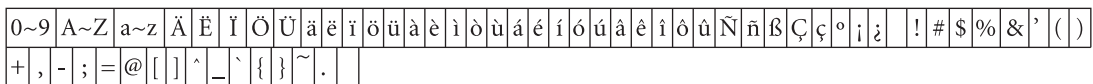

Japanese

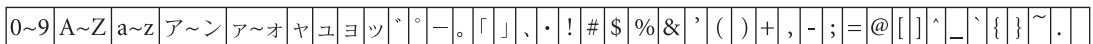

Connections

Connectors

⚠ CAUTION

Before connecting this instrument to other electronic components, turn off the power to all the components. Before turning the power on or off to all components, set all volume levels to minimum (0). Otherwise, electrical shock or damage to the components may occur.

For information about location of these connectors, refer to “Panel Controls and Terminals” on page 11.

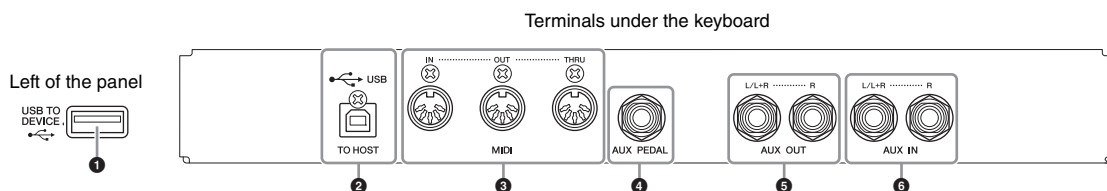

1 [USB TO DEVICE] terminal

This terminal allows connection to USB storage devices. Refer to “Precautions when using the [USB TO DEVICE] terminal” on page 51.

2 USB [TO HOST] terminal

This terminal allows direct connection to a personal computer. Refer to “Connecting a computer” on page 52 for more information.

3 MIDI [IN], [OUT], [THRU] terminals

Use MIDI cables to connect external MIDI devices to these connectors. Refer to “Connecting External MIDI Devices” on page 53 for more information.

4 [AUX PEDAL] jack

A separately sold FC7 foot controller or FC4/FC5 foot switch can be connected to this jack. By using an FC7 you can control the volume while playing to add expression to your performance, or control various other functions. By using an FC4/FC5, you can switch various selected functions on/off. To select the function that will be controlled, use the “AuxPedalFunc” (page 65) of the VOICE SETTING. The [PLAY/PAUSE] function can also be assigned to a foot switch (page 70).

5 AUX OUT [L/L+R], [R] jacks

These jacks let you connect the Clavinova to external powered speaker systems, for playing in larger venues at higher volumes.

NOTICE

When the Clavinova’s AUX OUT jacks are connected to an external system, first turn on the power to the Clavinova, then to the external system. Reverse this order when you turn the power off.

NOTE

There are two different types of USB terminals on the instrument: [USB TO DEVICE] and USB [TO HOST]. Take care not to confuse the two terminals and the corresponding cable connectors. Be careful to connect the proper plug in the proper direction.

NOTE

Connect or disconnect the pedal when the power of this instrument is turned off.

NOTE

Never route the sound output from the AUX OUT jacks to the AUX IN jacks. When the sound from the AUX OUT jacks is routed to the AUX IN jacks, the input sound will be output from the speaker of this instrument. The output sound may be excessively loud and may cause noise.

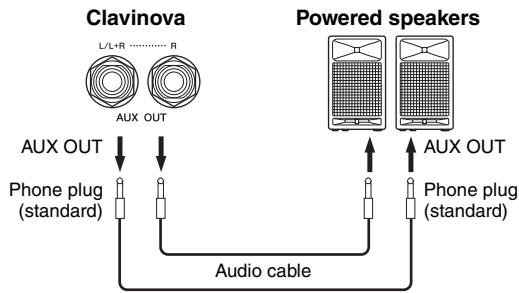

NOTE

Use audio cables and adaptor plugs with no resistance.

NOTE

Do not route the output from the AUX OUT jacks to the AUX IN jacks. (If you connect the Clavinova's AUX OUT jacks to an external system such as Powered speakers, do not connect the Powered speakers to Clavinova's AUX IN jacks.)

NOTE

If you connect the Clavinova to a monaural device, use only the AUX OUT [L/L+R] jack.

The Clavinova's [MASTER VOLUME] setting will affect the sound that is output from AUX OUT jacks. When the Clavinova's AUX OUT jacks are connected to an external speaker and you want to turn off the speaker sound of the Clavinova, switch the speaker off (page 71). Moreover, the tone quality of the instrument sound output from the speakers and the headphones changes automatically to the appropriate settings according to how the instrument is being used (see chart below).

Sound output condition from the instrument

Speakers sound
 Speakers do not sound

| | No plugs connected to AUX OUT jacks | | | Plugs connected to AUX OUT jacks | | |
|---------------------------------|--|---|--------------|----------------------------------|-------------------------------------|--------------|
| | Speakers On | Speakers Normal (Headphones Switch) | Speakers Off | Speakers On | Speakers Normal (Headphones Switch) | Speakers Off |
| Headphones connected | Optimum equalization for speakers applied* | Flat | Flat | Flat* | Flat | Flat |
| Headphones not connected | Optimum equalization for speakers applied | Optimum equalization for speakers applied | Flat | Flat* | Flat* | Flat |

* The output level of the headphones and AUX OUT is lowered.

6 AUX IN [L/L+R] [R] jacks

The stereo outputs from another instrument can be connected to these jacks, allowing the sound of an external instrument to be reproduced via the Clavinova's speakers. Refer to the diagram below and use audio cables for connection.

NOTICE

When the Clavinova's AUX IN jacks are connected to an external device, first turn on the power to the external device, then to the Clavinova. Reverse this order when you turn the power off.

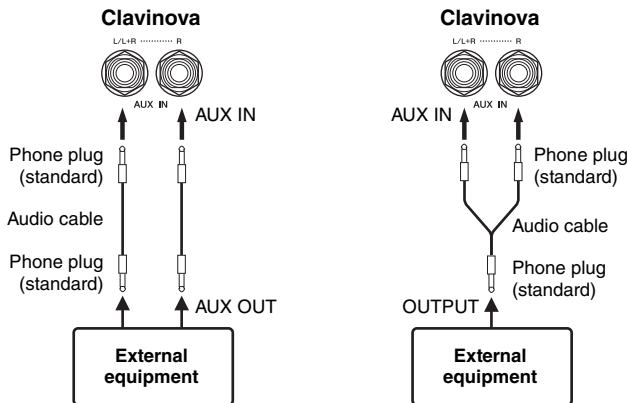

Connecting a USB storage device

This instrument features a built-in [USB TO DEVICE] terminal. When connecting a USB device to the terminal, be sure to handle the USB device with care. Follow the important precautions below.

Precautions when using the [USB TO DEVICE] terminal

This instrument features a built-in [USB TO DEVICE] terminal. When connecting a USB device to the terminal, be sure to handle the USB device with care. Follow the important precautions below.

NOTE

For more information about the handling of USB devices, refer to the owner's manual of the USB device.

■ Compatible USB devices

- USB storage devices (flash memory, hard disk drive, etc.)
- USB hub

The instrument does not necessarily support all commercially available USB devices. Yamaha cannot guarantee operation of USB devices that you purchase. Before purchasing a USB device for use with this instrument, please visit the following web page: <http://music.yamaha.com/download/>

NOTE

Other USB devices such as a computer keyboard or mouse cannot be used.

■ Connecting USB device

When connecting a USB device to the [USB TO DEVICE] terminal, make sure that the connector on the device is appropriate and that it is connected in the proper direction.

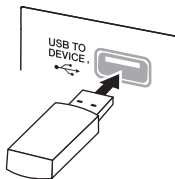

NOTICE

When connecting a USB device to the [USB TO DEVICE] terminal on the top panel, remove it before closing the key cover. If the key cover is closed with the USB device connected, the USB device may be damaged.

- When connecting a USB cable, Use it less than 3 meters.
- If you intend to connect two or three devices at the same time to a terminal, you should use a USB hub device. The USB hub must be self-powered (with its own power source) and the power must be on. Only one USB hub can be used. If an error message appears while using the USB hub, disconnect the hub from the instrument, then turn on the power of the instrument and re-connect the USB hub.
- Though the instrument supports the USB 1.1 standard, you can connect and use a USB 2.0 storage device with the instrument. However, note that the transfer speed is that of USB 1.1.

Using USB Storage Devices

By connecting the instrument to a USB storage device, you can save data you've created to the connected device, as well as read data from the connected device.

■ The number of USB storage device to be used

Up to two USB storage devices can be connected to the [USB TO DEVICE] terminal. (If necessary, use a USB hub. The number of USB storage devices that can be used simultaneously with musical instruments even when a USB hub is used is a maximum of two.) This instrument can recognize up to four drives in one USB storage device.

■ Formatting USB storage media

When a USB storage device is connected or media is inserted, a message may appear prompting you to format the device/media. If so, execute the Format operation (page 46).

NOTICE

The format operation overwrites any previously existing data. Make sure that the media you are formatting does not contain important data. Proceed with caution, especially when connecting multiple USB storage media.

■ To protect your data (write-protect)

To prevent important data from being inadvertently erased, apply the write-protect provided with each storage device or media. If you are saving data to the USB storage device, make sure to disable write-protect.

■ Connecting/removing USB storage device

Before removing the media from the device, make sure that the instrument is not accessing data (such as in the Save, Copy, Delete and Format operations).

NOTICE

Avoid frequently turning the power on/off to the USB storage device, or connecting/disconnecting the device too often. Doing so may result in the operation of the instrument "freezing" or hanging up. While the instrument is accessing data (such as during Save, Copy, Delete, and Format operations) or is mounting the USB storage device (shortly after the connection), do NOT unplug the USB connector, do NOT remove the media from the device, and do NOT turn the power off to either device. Doing so may corrupt the data on either or both devices.

Connecting a computer

By connecting a computer to the USB [TO HOST] or MIDI terminals, you can transfer data between the instrument and the computer via MIDI, and take advantage of sophisticated computer music software.

1. Before connection, turn off the power of this instrument.

2. Start the computer.

Do not start any applications on the computer.

3. Connect the instrument and compute via a USB cable.

Make the connection directly without passing through a USB hub.

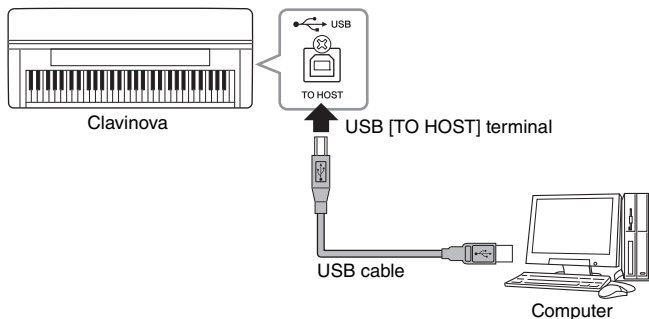

4. Turn on the power of this instrument.

The USB-MIDI driver will be installed to the computer automatically.

OS: Windows XP (SP3 and later), Windows Vista, Windows 7, Mac OS X Version 10.5 – 10.6.x

When data communication is unstable or some problem occurs even though you've executed the above instructions, download the Yamaha Standard USB-MIDI driver from the following URL then install it to your computer. For instructions on installation, refer to the Install Guide included in the package file.

<http://music.yamaha.com/download/>

For details about OS for Yamaha Standard USB-MIDI driver, visit the URL above.

NOTE

Also the MIDI [IN] and [OUT] terminals can be used to make the connection between the computer and the instrument. In this case, use the MIDI interface such as Yamaha UX16 instead of a USB cable. For instruction on connecting, refer to the manual of the MIDI interface.

NOTE

For information on setting up your sequence software, refer to the owner's manual of the relevant software.

Precautions when using the USB [TO HOST] terminal

When connecting the computer to the USB [TO HOST] terminal, make sure to observe the following points. Failing to do so risks freezing the computer and corrupting or losing the data. If the computer or the instrument freezes, restart the application software or the computer OS, or turn the power to the instrument off then on again.

NOTICE

- Use an AB type USB cable of less than 3 meters. USB 3.0 cables cannot be used.
- Before connecting the computer to the USB [TO HOST] terminal, exit from any power-saving mode of the computer (such as suspend, sleep, standby).
- Before turning on the power to the instrument, connect the computer to the USB [TO HOST] terminal.
- Execute the following before turning the power to the instrument on/off or plugging/unplugging the USB cable to/from the USB [TO HOST] terminal.
 - Quit any open application software on the computer.
 - Make sure that data is not being transmitted from the instrument. (Data is transmitted only by playing notes on the keyboard or playing back a song.)
- While the computer is connected to the instrument, you should wait for six seconds or more between these operations: (1) when turning the power of the instrument off then on again, or (2) when alternately connecting/disconnecting the USB cable.

Connecting external MIDI devices

The sophisticated MIDI functions give you powerful tools to expand your music performance and creation possibilities. Use the MIDI terminals and standard MIDI cables to connect external MIDI devices (keyboard, sequencer, etc.)



CAUTION

Before connecting the instrument to other MIDI devices, turn off the power of all the components.

- **MIDI [IN]**

Receives MIDI messages from another MIDI device.

- **MIDI [OUT]**

Transmits MIDI messages generated on this instrument to another MIDI device.

- **MIDI [THRU]**

Simply relays the MIDI messages received at MIDI IN.

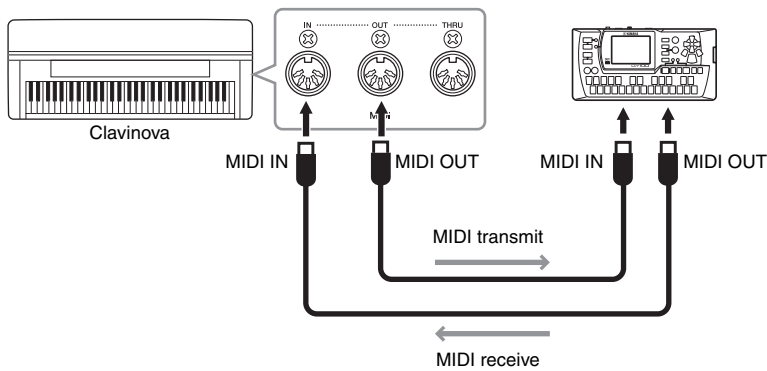

NOTE

For details about MIDI, refer to "MIDI Basics" (page 7).

NOTE

Since MIDI data that can be transmitted or received varies depending on the type of MIDI device, check the MIDI Data Format to find out what MIDI data and commands your devices can transmit or receive. The MIDI Data Format is contained in the "Data List Complete Version" (downloadable from the Yamaha website).

Detailed Settings

Parameter List

Recording and playback — [FILE/SONG SETTING]

Settings marked with a “*” are effective only when a MIDI Song is selected.

| Settings | Parameter name | Default settings | Reference page |
|---|-----------------|------------------|----------------|
| Deleting files | Delete | — | page 43 |
| Renaming files | Rename | — | page 43 |
| Copying files* | Copy | — | page 44 |
| Moving files* | Move | — | page 45 |
| Making folders in the USB storage device | MakeFolder | — | page 45 |
| Formatting a USB storage device* | Format | — | page 46 |
| Converting a MIDI Song to an Audio Song during playback* | MIDItoAUDIO | — | page 46 |
| Confirming the amount of free memory area and all memory area on the USB storage device | DriveProperty | — | page 47 |
| Automatically selecting a Song when connecting the USB storage device | SongAutoOpen | MIDI | page 48 |
| Changing the type of characters on the display | CharCode | International | page 48 |
| Playing back a Song/all Songs repeatedly | SongRepeat | Off | page 57 |
| Playing back the phrase specified by the phrase number* | PhraseMark | RepeatOff | page 58 |
| Correcting note timing* | Quantize | 1/16 | page 58 |
| Setting the Quantize strength* | | 100% | |
| Specifying whether playback starts immediately along with the first voicing* | QuickPlay | On | page 59 |
| Auditioning the channels* | ChannelListen | Ch1 | page 59 |
| Deleting data from each channel* | ChannelClear | Ch1 | page 59 |
| Selecting a record starting method | RecStart | Normal | page 38 |
| Selecting a record ending method | RecEnd | Replace | page 38 |
| Recording Parts 3 – 16 (Extra Parts) | RecExtraPartsCh | Ch5 | page 36 |

Metronome — METRONOME [SETTING]

| Settings | Parameter name | Default settings | Reference page |
|--------------------------------------|-----------------|---|----------------|
| Setting the metronome time signature | TimeSignature | 4/4 (when a MIDI Song is selected, depending on the Song) | page 60 |
| Setting the metronome volume level | MetronomeVolume | 82 | page 60 |
| Selecting the metronome | MetronomeSound | BellOff | page 60 |

Voices — [VOICE SETTING]

In Dual mode, parameters marked with a "***" are set for Voice 1 and Voice 2 individually.

| Settings | Parameter name | Default settings | Reference page |
|---|-----------------|----------------------|----------------|
| Setting the octave* | Octave | Depends on the Voice | page 61 |
| Setting the volume level* | Volume | | page 61 |
| Setting the position of right and left channels* | Pan | | page 62 |
| Make fine adjustments to the pitch (only in Dual mode) | Detune | | page 62 |
| Selecting the reverb type | ReverbType | | page 62 |
| Setting the reverb depth* | ReverbSend | | page 62 |
| Selecting the chorus type | ChorusType | | page 62 |
| Setting the chorus depth* | ChorusSend | | page 63 |
| Setting the chorus on/off* | ChorusOnOff | | page 63 |
| Selecting the DSP type* | DSP Type | | page 63 |
| Setting the speed of the Vibraphone vibrato effect (only the VibeRotor is selected for the DSP Type parameter)* | VibeRotorSpeed | | page 63 |
| Turning the vibraphone Vibrato effect on/off (only the VibeRotor is selected for the DSP Type parameter)* | VibeRotorOnOff | | page 64 |
| Setting the rotation speed of the rotary speaker (only the Rotary is selected for the DSP Type parameter)* | RotarySpeed | | page 64 |
| Adjusting the depth of the DSP effect* | DSP Depth | | page 64 |
| Adjusting the brightness of the sound* | Brightness | | page 64 |
| Adjusting the resonance effect* | HarmonicContent | | page 64 |
| Setting the touch sensitivity* | TouchSense | | page 64 |
| Setting the right pedal function | RPedalFunc | SustainCont | page 65 |
| Setting the center pedal function | CPedalFunc | Sostenuto | page 65 |
| Setting the left pedal function | LPedalFunc | Soft | page 65 |
| Setting the auxiliary pedal function | AuxPedalFunc | Expression | page 65 |
| Turning the right pedal function on/off | RPedalOnOff | Depends on the Voice | page 66 |
| Turning the center pedal function on/off | CPedalOnOff | | page 66 |
| Turning the left pedal function on/off | LPedalOnOff | | page 66 |
| Turning the auxiliary pedal function on/off | AuxPedalOnOff | | page 66 |

Detailed settings of acoustic effects

| Settings | Parameter name | Default settings | Reference page |
|---|--------------------------|------------------|----------------|
| Setting the I.A. Control depth | Acoustic Control Depth | 0 | page 67 |
| Setting the GP Soundboard Speaker depth | Soundboard Speaker Depth | 110 | page 67 |

Other settings — [FUNCTION]

| Settings | Parameter name | Default settings | Reference page |
|--|----------------------|--|----------------|
| Changing the key | Transpose | Master | page 68 |
| Determines the amount of pitch transposition | | 0 | |
| Selecting a touch response | TouchResponse | Medium | page 68 |
| Determines the fixed volume setting | | 64 | |
| Fine tuning the pitch | Tune | A3 = 440.0Hz | page 69 |
| Selecting a tuning curve for a piano Voice | PianoTuningCurve | Stretch | page 69 |
| Selecting a scale | Scale | Equal | page 69 |
| Determines the fundamental (root) note for the scale | | C | |
| Specifying the Split Point | SplitPoint | F#2 | page 70 |
| Assigning the [PLAY/PAUSE] function to the pedal | PedalPlay/Pause | Off for all pedals | page 70 |
| Selecting a type of auxiliary pedal | AuxPedalType | Make | page 70 |
| Setting the point at which the damper pedal starts to affect the sound | HalfPedalPoint | 0 | page 70 |
| Adjusting the depth of the Soft pedal | SoftPedalDepth | 5 | page 70 |
| Setting the depth of String Resonance | StringResonanceDepth | 5 | page 71 |
| Setting the depth of Sustain Sampling for the damper pedal | SustainSamplingDepth | 5 | page 71 |
| Specifying the volume of the key-off sound | KeyOffSamplingDepth | 5 | page 71 |
| Setting the range of pitch bend | PitchBendRange | 2 | page 71 |
| Switching the speaker on/off | Speaker | Normal (HeadphoneSW) | page 71 |
| Setting the MIDI transmit channel | MidiOutChannel | Main: Midi/Usb1 Ch1 Left: Midi/Usb1 Ch2 M.L.(MainLayer): Midi/Usb1 Ch3 L.L.(LeftLayer): Midi/Usb1 Ch4 | page 72 |
| Selecting performance from the keyboard or Song data for MIDI transmission | | Keyboard | |
| Setting the MIDI receive channel | MidiInChannel | Midi/Usb1 Ch1 – Ch16: Song Usb2 Ch1: Keyboard Usb2 Ch2: Main Usb2 Ch3: Left Usb2 Ch4: M.L. (MainLayer) Usb2 Ch5: L.L. (LeftLayer) Usb2 Ch6 – Ch16: Off | page 72 |
| Turning Local Control on/off | LocalControl | On | page 72 |
| Selecting the type of data received via MIDI | ReceiveParameter | On for all types of data | page 72 |
| Selecting the type of data transmitted via MIDI | TransmitParameter | On for all types of data | page 73 |
| Transmitting the default settings of the panel | InitialSetup | — | page 73 |
| Selecting items saved at shutdown | MemoryBackup | The Transpose, Main/LeftVoice, MetronomeSetting, and Function parameters are set to Off. Other parameters are set to On. | page 73 |
| Restoring the factory default settings | FactorySet | MemorySongExcluded | page 73 |
| Saving/Loading backup file for internal data | FullBackup | — | page 74 |

Detailed settings for recording and playback — [FILE/SONG SETTING]

For information on the settings “Delete” through “CharacterCode,” see “Handling Song files — [FILE/SONG SETTING]” on page 41.

You can make detailed settings for the selected Song. First, select the desired Song from “PRESET,” “MEMORY,” or “USB1” (see page 28).

Select the desired Song and press the [FILE/SONG SETTING] button to access the “File/SongSetting” menu.

Select the parameters to be set by using the A [-]/[+] buttons.

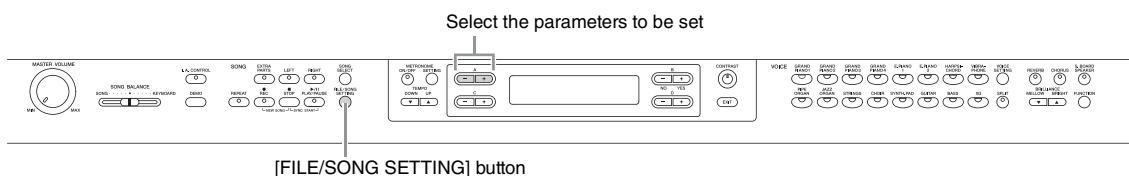

Settings marked with a “*” are effective only when a MIDI Song is selected.

Playing back a Song / all Songs repeatedly

SongRepeat

You can continuously play 50 Piano Preset Songs, all Songs saved in a designated folder in the USB storage device, or repeatedly play a single Song.

When you start playback, the instrument plays the Song you selected using the front panel, then starts repeat playback of the specified Songs until you press the [STOP] button.

Select the playback method.

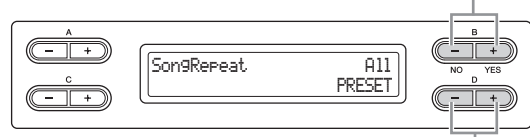

Specify the repeated Songs.

Playback method:

- **Off**
Disables repeated playback.
- **Single**
Repeatedly plays back a selected single Song.
- **All**
Continuously plays back all Songs within a designated range in order.

- **Random**
Continuously plays back all Songs within a designated range in random order.
- Range designated for repeated playback:**
- **PRESET**
All 50 Preset Songs
 - **MEMORY**
All Songs in the instrument's MEMORY drive
 - **USB1 – USBx**
All MIDI Songs in designated folder in the connected USB storage device
 - **USB AUDIO**
All Audio Songs in designated folder in the connected USB storage device

NOTE
When you selected “Off” or “Single” for Playback method, the range designated for repeated playback cannot be changed. The “---” is appeared in the lower right of the display.

Playing back the phrase specified by the phrase number*

PhraseMark

If you select a Song from an ensemble collection disk, such as the “XG for Piano” disks, you can specify phrase numbers in the score to play back from the score from the mark point, or to play back the phrase repeatedly.

If you start playing back a Song with “Repeat On” selected, the count down starts, followed by the repeated playback of the specified phrase until you press the [STOP] button.

If you select “Repeat Off,” normal playback starts without repeat.

Select repeat on or off.

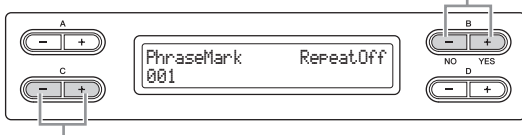

Specify the phrase number.

Setting range of the phrase number:

--- (not specified)

000 – the last phrase number of the Song

NOTE

If you select any Song without the phrase marks, you can select only “Off.”

Correcting note timing*

Quantize

You can correct the timing of notes. For example, you can adjust recorded notes to precise eighth or sixteenth notes. Changes are made by Song.

Stores the changed value.

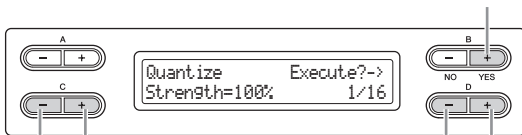

Set the Quantize strength.

Specifies the type of note.

Notes for which you can adjust the timing:

| | | |
|----------------|--|---------------------------------------|
| 1/4..... | | quarter note |
| 1/6..... | | quarter note triplet |
| 1/8..... | | eighth note |
| 1/12..... | | eighth note triplet |
| 1/16..... | | sixteenth note |
| 1/24..... | | sixteenth note triplet |
| 1/32..... | | thirty-second note |
| 1/8+1/12..... | | eighth note + eighth note triplet* |
| 1/16+1/12..... | | sixteenth note + eighth note triplet* |
| 1/16+1/24..... | | sixteenth note + sixteenth triplet* |

The three Quantize settings marked with asterisks (*) are exceptionally convenient, since they allow you to quantize two different note values at the same time. For example, when the straight eighth notes and eighth notes triplet are contained in the same part, if you quantize by the straight eighth notes, all notes in the part are quantized to straight eighth notes—completely eliminating any triplet feel.

However, if you use the eighth note + eighth note triplet setting, both the straight and triplet notes will be quantized correctly.

Default setting:

1/16

Setting the Quantize strength*

From this display, you can determine how strongly the notes will be quantized. A setting of 100% produces exact timing. If a value less than 100% is selected, notes will be moved toward the specified quantization beats according to the specified percentage. Applying less than 100% quantization lets you preserve some of the “human” feel in the recording.

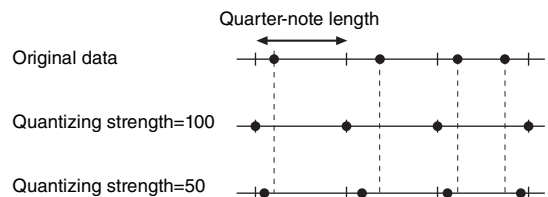

Setting range:

0% – 100%

Default setting:

100%

Specifying whether playback starts immediately along with the first voicing*

QuickPlay

This parameter enables you to specify whether a Song that starts from the middle of a bar, or a Song with a silence prior to the first note, should be played from the first note or from the top of the bar (rest or blank).

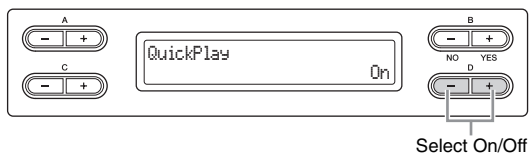

Setting range:

- **On**
Playing from the first note
- **Off**
Playing from the top of the bar (including a rest or blank)

Default setting:

On

Auditioning the channels*

ChannelListen

You can select a single channel to listen to its contents. Playback starts from the first note.

Playback continues as long as you press and hold down this button.

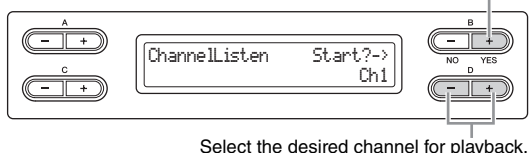

Setting range:

Ch1 – Ch16

Default setting:

Ch1

NOTE

The Song data consists of 16 channels. A channel is assigned to a part, so in this instrument, channel means the same as part.

NOTE

Even channels that contain no data are displayed.

Deleting data from each channel*

ChannelClear

You can delete data from each of the 16 channels.

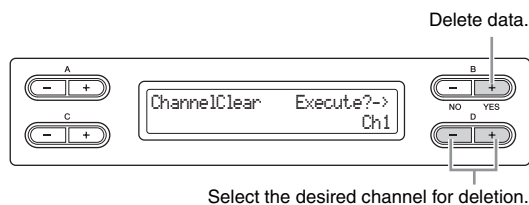

Setting range:

Ch1 – Ch16, ALL (all channels)

Default setting:

Ch1

NOTE

The Song data consists of 16 channels. A channel is assigned to a part, so in this instrument, channel means the same as part.

NOTE

Even channels that contain no data are displayed.

NOTE

When you clear all channels using the "ALL" parameter, you can overwrite the Song. In this case, the file which contains Song settings with no channel data is saved.

For information on the settings "RecStart" and "RecEnd," see "Re-recording a Song partially" on page 37.

For information on the setting "RecExtraPartsCh," see "Multi Recording of specific Parts" on page 36.

Detailed settings for the metronome — METRONOME [SETTING]

You can set the time signature, volume level, and voice of the instrument's metronome.

Press the METRONOME [SETTING] button to access the Metronome Setting menu. Select the parameters to be set by using the A [-]/[+] buttons.

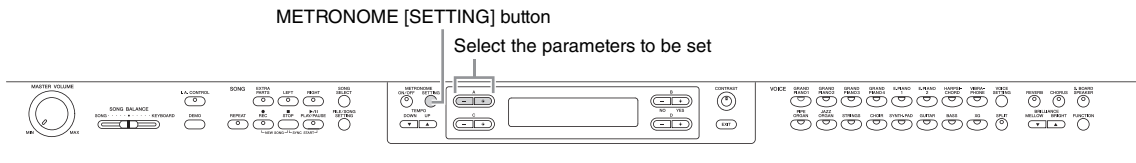

Setting the metronome time signature

TimeSignature

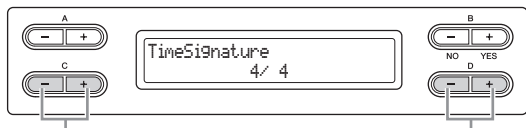

Set the numerator of the time signature.

Set the denominator of the time signature.

For example, to specify “3/4,” use the C [-]/[+] buttons to select “3” and the D [-]/[+] buttons to select “4”

Setting range for the numerator:

1 – 16

Setting options for the denominator:

2, 4, and 8

Default setting:

4/4 (when a MIDI Song is selected; depends on the particular Song)

Setting the metronome volume level

MetronomeVolume

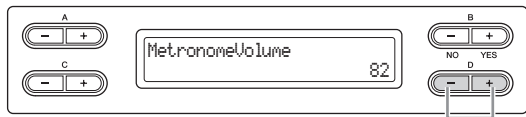

Change the setting

Setting range:

0 – 127

Default setting:

82

Selecting the metronome voice

MetronomeSound

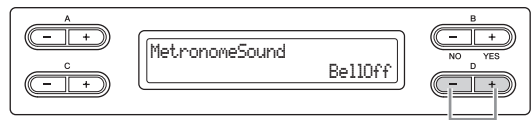

Change the setting

Setting range:

- **BellOn**
Click and bell
- **BellOff**
Click (standard metronome sound)
- **EnglishVoice**
Click and “1, 2, 3, 4” in English
- **GermanVoice**
Click and “1, 2, 3, 4” in German
- **JapaneseVoice**
Click and “1, 2, 3, 4” in Japanese
- **FrenchVoice**
Click and “1, 2, 3, 4” in French
- **SpanishVoice**
Click and “1, 2, 3, 4” in Spanish

Default setting:

BellOff

NOTE

To mute the beat count, select “BellOff.”

Detailed settings for Voices — [VOICE SETTING]

This menu enables you to make various detailed Voice settings such as Dual, Split, Acoustic Effects, and the pedal functions. You can make these settings for each Voice (or each combination of Voices) individually. You can change the settings while playing the keyboard and listening to the sound.

Select a Voice or Voices (Voices 1 – 2 for the right hand and Voices 1 – 2 for the left hand), press the [VOICE SETTING] to enter the Voice Setting mode then use the A [-][+] buttons to select the desired item.

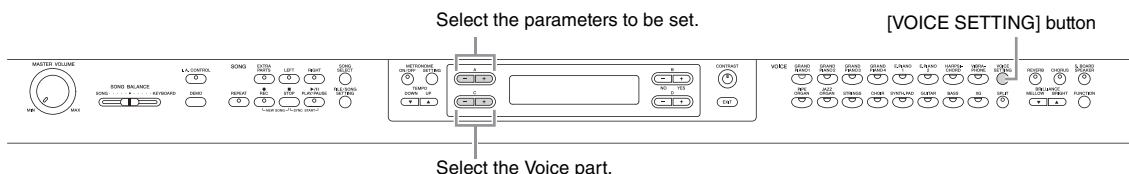

Use the C [-][+] buttons to select a Voice part to which the setting is applied, then make the setting of the selected item.

Voice part

- Main**
 When this is selected, the setting is applied to Voice 1 for the right hand.
- M.L. (Main Layer)**
 Available when the right hand area is in the Dual mode. When this is selected, the setting is applied to Voice 2 for the right hand.
- Main × Layer**
 Available when the right hand area is in the Dual mode. When this is selected, the setting is applied to both Voice 1 and Voice 2 for the right hand.
- Left**
 Available when the instrument is in the Split mode. When this is selected, the setting is applied to Voice 1 for the left hand.
- L.L. (Left Layer)**
 Available when the instrument is in the Split mode and the left hand area is in the Dual mode. When this is selected, the setting is applied to Voice 2 for the left hand.
- Left × Layer**
 Available when the instrument is in the Split mode and the left hand area is in the Dual mode. When this is selected, the setting is applied to both Voice 1 and Voice 2 for the left hand.

In the Dual mode, parameters with the “*” mark are set for Voice 1 and Voice 2 individually.

Setting the octave*

Octave

The pitch of a note can be shifted upward or downward in steps of an octave.

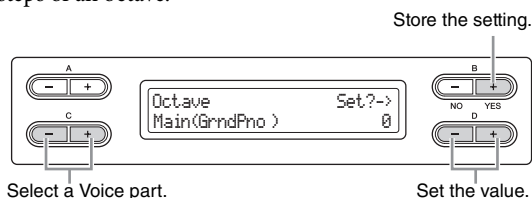

Setting range:
-2 (two octaves lower) – 0 (no pitch shift) – +2 (two octaves higher)

Default setting:
Differs depending on the Voice.

Setting the volume level*

Volume

You can set the volume level for each Voice part.

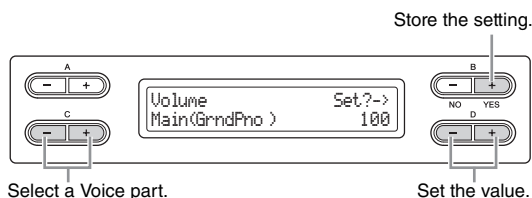

Setting range:
0 – 127

Default setting:
Differs depending on the Voice.

Setting the position of right and left channels*

Pan

You can specify the position in the stereo image from which you hear the sound.



Setting range:

L64 (hard left) – C (center) – R63 (hard right)

Default setting:

Differs depending on the Voice.

Make fine adjustments to the pitch (only in Dual mode)

Detune

The pitch of the two sounds selected in the Dual mode can be “skewed” slightly away from each other.

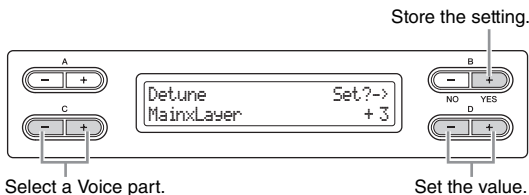

Setting range:

-20 – +20 (Positive (+) settings will raise the pitch of Voice 1 and lower the pitch of Voice 2. Negative (-) settings will do the opposite.)

Default setting:

Differs depending on the Voice.

Selecting the reverb type

ReverbType

The Reverb Type selection is applied to all the Voice parts commonly or the instrument entirely.

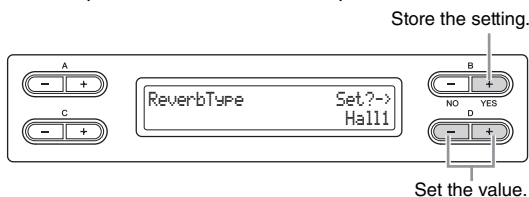

Setting range:

- **Room**
Simulates reverberation in a room.
- **Hall1**
Simulates reverberation in a concert hall.
- **Hall2**
Reverberation is slightly longer than that of “Hall1.”
- **Stage**
Reverberation suitable for a solo instrument sound.
- **Plate**
Reverberation simulating that created by vibration of a metal plate.

Default setting:

Differs depending on the Voice or Voice combination.

Setting the reverb depth*

ReverbSend

NOTE

The reverb effect is not applied if the ReverbSend parameter is set to “0.”



Setting range:

0 – 127

Default setting:

Differs depending on the Voice.

Selecting the chorus type

ChorusType

The Chorus Type selection is applied to all the Voice parts commonly or the instrument entirely.

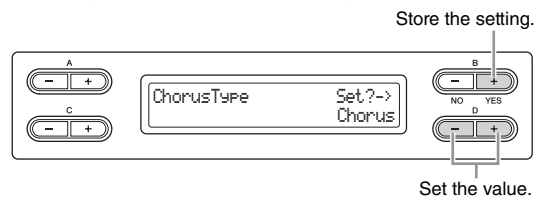

Setting range:

- **Chorus**
Adds a rich, spacious sound.
- **Celeste**
Adds swell and a spacious sound.
- **Flanger**
Adds swell effects similar to the sound of an ascending or descending jet plane.

Default setting:

Differs depending on the Voice or Voice combination.

Setting the chorus depth*

ChorusSend

NOTE

The reverb effect is not applied if the ChorusSend parameter is set to "0."

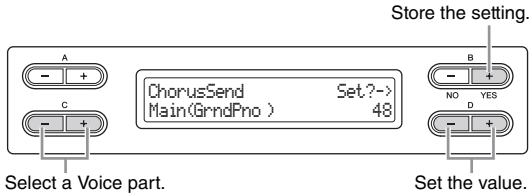

Setting range:

0 – 127

Default setting:

Differs depending on the Voice.

Setting the chorus on/off*

ChorusOnOff

You can set the [CHORUS] button on or off for each Voice. When you select a Voice, the chorus on/off setting for the Voice automatically changes according to this parameter.

NOTE

Even if this parameter is turned on, the chorus effect is disabled if the ChorusSend parameter is set to 0.

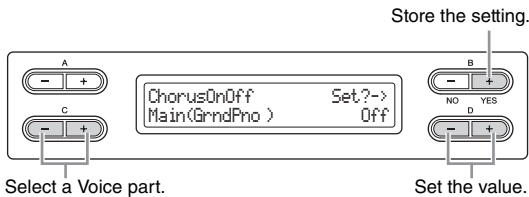

Setting range:

On/Off

Default setting:

Differs depending on the Voice.

Selecting the DSP type*

DSP Type

You can select other effects (than reverb and chorus).

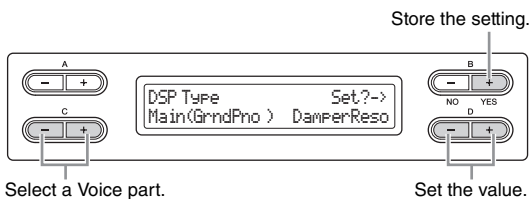

Setting range:

- **DamperReso (Damper Resonance)**
Simulates resonance obtained by pressing the damper pedal.
- **DelayLCR**
Delay applied at left, center, and right positions.
- **DelayLR**
Delay applied at left and right positions.
- **Echo**
Echo-like delay
- **CrossDelay**
Left and right delays are crossed.
- **Symphonic**
Adds a rich and deep acoustic effect.
- **Rotary**
Adds the vibrato effect of a rotary speaker.
- **Tremolo**
The volume level changes in rapid cycles.
- **VibeRotor**
The vibrato effect of a vibraphone.
- **AutoPan**
The sound pans left to right and back and forth.
- **Phaser**
The phase changes periodically, swelling the sound.
- **AutoWah**
The center frequency of the wah filter changes periodically.
- **Off**
No effect.

Default setting:

Differs depending on the Voice.

Setting the speed of the Vibraphone vibrato effect*

VibeRotorSpeed

Rotor:

The rotating portion of an electrical device etc.

This will be displayed only if VibeRotor is selected for the DSP Type parameter explained above. This sets the speed of the vibrato effect that is applied when you have selected Vibraphone and are using the VibeRotor pedal.

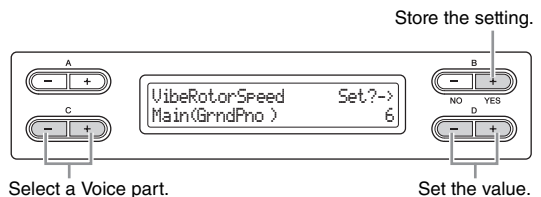

Setting range:

1 – 10

Default setting:

Differs depending on the Voice.

Turning the Vibraphone vibrato effect on/off*

VibeRotorOnOff

This will be displayed only if VibeRotor is selected for the DSP Type parameter explained above. It turns on/off the vibrato effect that is applied when you use the VibeRotor pedal.

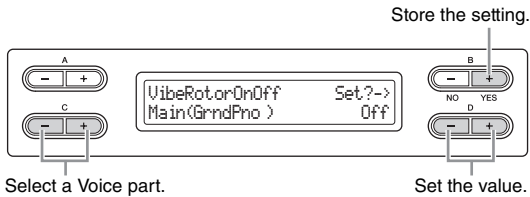

Setting range:

On/Off

Default setting:

Differs depending on the Voice.

Setting the rotation speed of the rotary speaker*

RotarySpeed

This will be displayed only if Rotary is selected for the DSP Type parameter explained above. It sets the rotation speed of the rotary speaker effect.

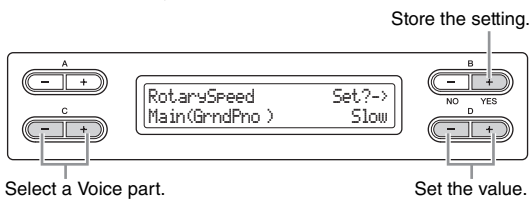

Setting range:

Slow/Fast

Default setting:

Differs depending on the Voice.

Adjusting the depth of the DSP effect*

DSP Depth

This sets the depth of the DSP effect (page 63). Some DSP Type settings do not allow you to set the DSP Depth.

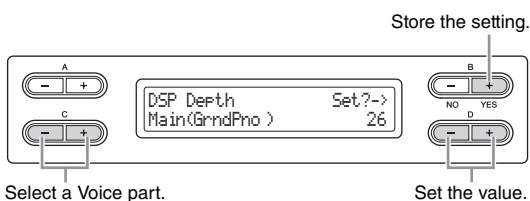

Setting range:

1 (output only the original sound with almost no effect applied) – 127 (output only the sound processed by the effect)

Default setting:

Differs depending on the Voice.

Adjusting the brightness of the sound*

Brightness

NOTE

Brightness may have little audible effect or not be applied to some Voices.



Setting range:

-64 – +63 (The higher the value, the brighter the sound.)

Default setting:

Differs depending on the Voice.

Adjusting the resonance effect*

HarmonicContent

Resonance can produce a distinctive “peaky” tone, making the sound brighter and harder.

NOTE

Harmonic content may have little audible effect or not be applied to some Voices.



Setting range:

-64 – +63

Default setting:

Differs depending on the Voice.

Setting the touch sensitivity*

TouchSense

This parameter enables determines the manner and degree to which the volume level changes in response to your touch on the keyboard (how hard you play). Since

the volume level of Voices in the [HARPSICHOARD] and [PIPE ORGAN] do not change regardless of how you play the keyboard, the default setting for these Voices is 127. (See the setting range below.)

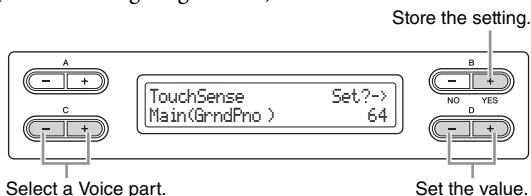

Setting range:

0 (softest) – 64 (largest changes in the level) – 127 (loudest and fixed)

Default setting:

Differs depending on the Voice.

NOTE

“TouchSense” determines the manner and degree to which the volume level changes in response to your touch on the keyboard. The MIDI note-on velocity data is not changed; the volume level is changed for the same velocity data.

Setting the right pedal function

RPedalFunc

Various functions (other than the original one) can be assigned to the right pedal.

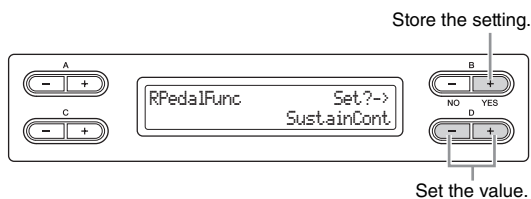

Setting range:

- **Sustain**
ON/OFF switch type damper
- **SustainCont (Sustain Continuously)**
Damper that sustains the sound proportionately to how deeply you press the pedal
- **Sostenuto**
Sostenuto (page 16)
- **Soft**
Soft (page 16)
- **Expression**
A function that lets you create changes in dynamics (volume) as you play
- **PitchBend Up**
A function that smoothly raises the pitch
- **PitchBend Down**
A function that smoothly lowers the pitch
- **RotarySpeed**
Change the rotational speed of the JazzOrgan rotary speaker (switch between fast/slow each time you press the pedal)
- **VibeRotor**
Switch the vibraphone vibrato on/off (switch on/off each time you press the pedal)

Default setting:

SustainCont

Setting the center pedal function

CPedalFunc

Various functions (other than the original one) can be assigned to the center pedal.

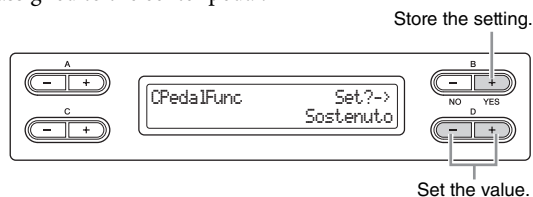

Setting range:

- **Sustain**
- **Sostenuto**
- **Soft**
- **RotarySpeed**
- **VibeRotor**

Default Setting:

Sostenuto

Setting the left pedal function

LPedalFunc

Various functions (other than the original one) can be assigned to the left pedal.

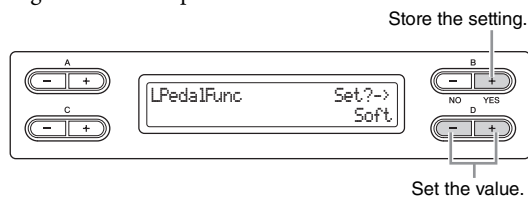

Setting range:

- **Sustain**
- **Sostenuto**
- **Soft**
- **RotarySpeed**
- **VibeRotor**

Default Setting:

Rotary Speed (JazzOrgan and MellowOrgan), Vibraphone (VibeRotor), Soft (other Voices)

Setting the auxiliary pedal function

AuxPedalFunc

You can assign a function to the pedal connected to the Clavinova's AUX PEDAL jack.

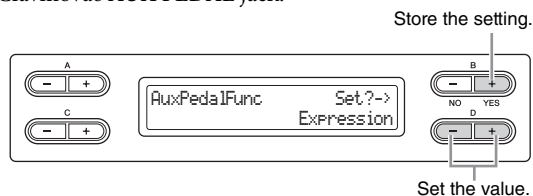

Detailed Settings

Detailed settings for Voices — [VOICE SETTING]

Setting range:

Same as "Setting the right pedal function" (page 65).

Default setting:

Expression

<Optional pedal>**Yamaha FC7 foot controller**

This foot controller is suitable for controlling Expression, SustainCont, or PitchBend Up/Down.

Yamaha FC4 foot switch**Yamaha FC5 foot switch**

These foot switches are suitable for controlling Sustain, Sostenuto, Soft, RotarySpeed, or VibeRotor.

Turning the right pedal function on/off

RPedalOnOff

This turns the right pedal function on or off for the relevant Voice part. In other words, you can select the desired Voice part and determine whether the right pedal function (set on page 65) will affect that part or not.

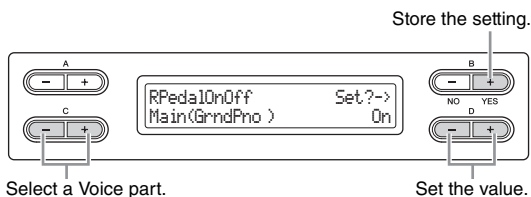
**Setting for:**

Main, M.L. (Main Layer), Left, L.L. (Left Layer)

Setting range:

On/Off

Default setting:

Differs depending on the Voice.

Turning the center pedal function on/off

CPedalOnOff

This turns the center pedal function on or off for the relevant Voice part. In other words, you can select the desired Voice part and determine whether the center pedal function (set on page 65) will affect that part or not.

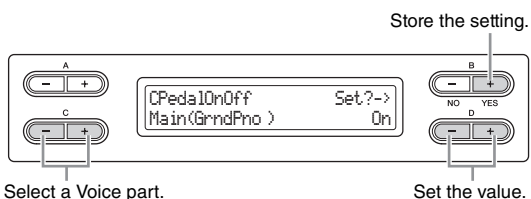
**Setting for:**

Main, M.L. (Main Layer), Left, L.L. (Left Layer)

Setting range:

On/Off

Default setting:

Differs depending on the Voice.

Turning the left pedal function on/off

LPedalOnOff

This turns the left pedal function on or off for the relevant Voice part. In other words, you can select the desired Voice part and determine whether the left pedal function (set on page 65) will affect that part or not.

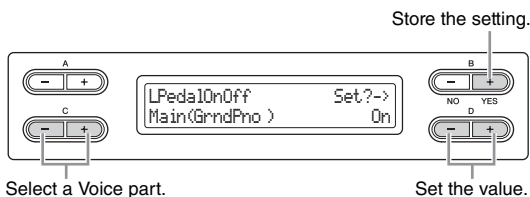
**Setting for:**

Main, M.L. (Main Layer), Left, L.L. (Left Layer)

Setting range:

On/Off

Default setting:

Differs depending on the Voice.

Turning the auxiliary pedal function on/off

AuxPedalOnOff

This turns the auxiliary pedal function on or off for the relevant Voice part. In other words, you can select the desired Voice part and determine whether the auxiliary pedal function (set on page 65) will affect that part or not.

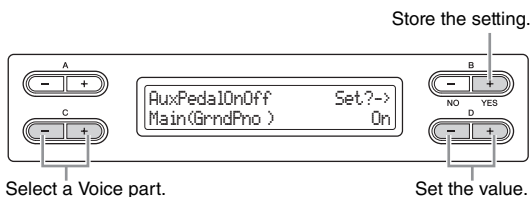
**Setting for:**

Main, M.L. (Main Layer), Left, L.L. (Left Layer)

Setting range:

On/Off

Default setting:

Differs depending on the Voice.

Detailed settings for acoustic effects

You can set the depth of the I.A. Control and GP Soundboard Speaker.

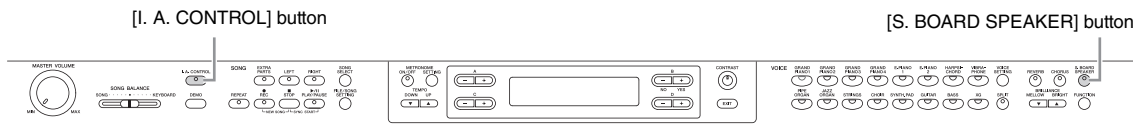

Setting the I.A. Control depth

Acoustic Control Depth

This sets the depth of the I.A. Control (page 14). Hold the [I.A. CONTROL] button and use the D [-]/[+] buttons to set the value. The higher the value, the more clearly that low and high sounds are heard at lower volume levels.

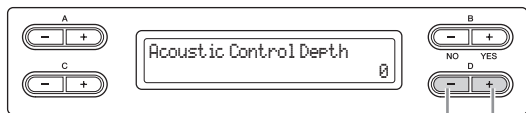

Change the setting.

Setting range:

-3 - +3

Default setting:

0

Setting the GP Soundboard Speaker depth

Soundboard Speaker Depth

This sets the depth of the GP Soundboard Speaker (page 15). Hold the [S. BOARD SPEAKER] button and use the D [-]/[+] buttons to set the value.



Change the setting.

Setting range:

0 - 127

Default setting:

110

Other settings — [FUNCTION]

You can make detailed settings for touch, tuning, scale, etc.

To call up the setting display, press the [FUNCTION] button and use the A [-]/[+] buttons.

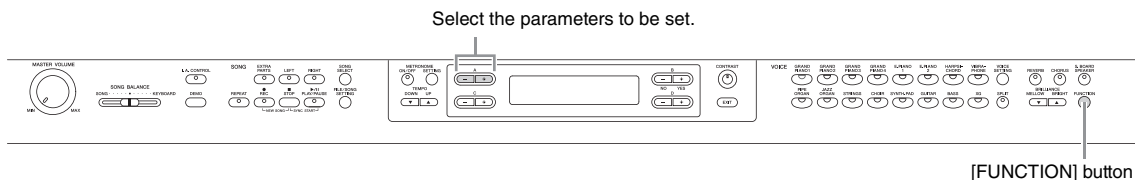

Changing the key

Transpose

TRANPOSE = To change the key

(Changing the key: To raise or lower the overall pitch of the entire Song.)

The Clavinova's Transpose function makes it possible to shift the pitch of the entire keyboard up or down in semitone intervals to facilitate playing in difficult key signatures, and to let you easily match the pitch of the keyboard to the range of a singer or other instruments. For example, if you set the transposition amount to "5," playing key C produces pitch F. In this way, you can play the Song as if it were in C major, and the Clavinova will transpose it to the key of F.

NOTE

Audio song playback cannot be transposed.

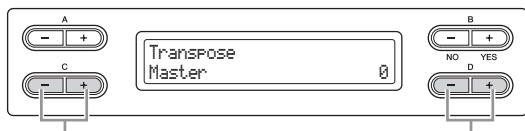

Select what sound the transpose is applied to.

Set the Transpose value.

Setting for:

- **Master**
The sound of the entire instrument (the manually-played sound and the Song playback).
- **Keyboard**
The manually-played sound.
- **Song**
The Song playback.

Default setting:

Master

Determines the amount of pitch transposition

Setting range:

-12 (-1 octave) – 0 (normal pitch) – +12 (+1 octave)

Default setting:

0

Selecting a touch response

TouchResponse

You can specify a touch response (how the sound responds to the way you play the keys).

Set the "Fixed" volume.

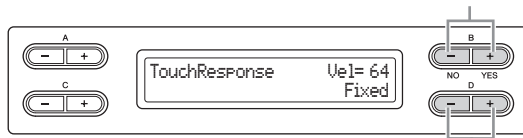

Select the setting.

Setting range:

- **Light**
With a soft touch, the Clavinova produces a loud sound. The volume level of tones tends to be consistent.
- **Medium**
Standard touch response.
- **Heavy**
You must hit the key very hard to generate a loud volume. This allows for versatile expression, from pianissimo to fortissimo tones.
- **Fixed**
No touch response. The volume level will be the same regardless of how hard you play the keys. Use the B [- (NO)] [+ (YES)] buttons to set the volume level.

Setting range of the "Fixed" volume level:

1 – 127

Default setting:

Medium

NOTE

"TouchResponse" determines the touch sensitivity of an instrument. The MIDI note-on velocity data is changed when you play the keyboard with a consistent touch.

Fine tuning the pitch

Tune

You can fine tune the pitch of the entire instrument. This function is useful when you play the Clavinova along with other instruments or CD music.

NOTE

The pitch of audio song playback cannot be fine tuned.

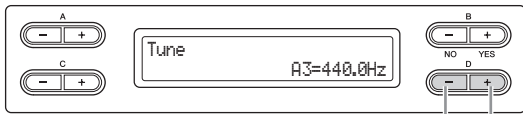

Set the value.

Setting range:

A3 = 414.8 Hz – 466.8 Hz (0.2 Hz steps)

Default setting:

A3 = 440.0 Hz

Selecting a tuning curve for a piano Voice

PianoTuningCurve

You can select a tuning curve from the Voices in the [GRAND PIANO 1] – [GRAND PIANO 4]. Select “Flat” if you feel the tuning curve of the piano Voice does not quite match that of other instruments’ Voices.

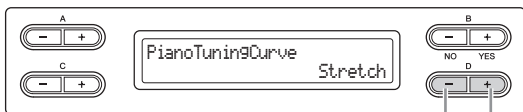

Select the setting.

Setting range:

- **Stretch**
Tuning curve particularly for pianos.
- **Flat**
Tuning curve in which the frequency is precisely octave doubled over the entire keyboard range.

Default setting:

Stretch

Selecting a scale

Scale

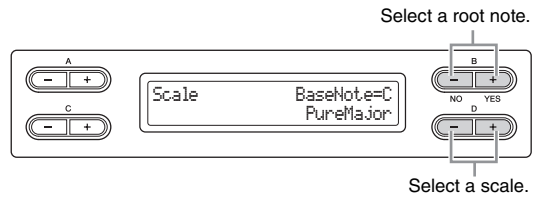

Select a root note.

Select a scale.

Setting range:

- **Equal**
One octave is divided into twelve equal intervals. Currently most popular piano tuning scale.
- **PureMajor/PureMinor**
Based on natural overtones, three major chords using these scales produce a beautiful, pure sound.
- **Pythagorean**
This scale, designed by Pythagoras, a Greek philosopher, is based on the interval of a perfect 5th. The 3rd produces swells, but the 4th and 5th are beautiful and suitable for some leads.
- **MeanTone**
This scale is an improvement of the Pythagorean in that the swell of the 3rd has been eliminated. It spread during the late 16th century through the late 18th century. Handel used this scale.
- **Werckmeister/Kirnberger**
These scales combine Mean Tone and Pythagorean in different ways. With these scales, modulation changes the impression and feel of the Songs. They were often used in the era of Bach and Beethoven. They are also often used now to reproduce the music of that era on harpsichords.

Default setting:

Equal

Determines the fundamental (root) note for the scale

If you select a scale other than Equal, you need to specify the root note using the B [- (NO)][+ (YES)] buttons.

Setting range:

C#, D, Eb, E, F, F#, G, Ab, A, Bb,

Default setting:

C

Specifying the Split Point

SplitPoint

You can specify the split point (the boundary between the right-hand and left-hand keyboard areas).

NOTE

You can also set the note for the Split Point directly from the keyboard, by pressing the desired key while "SplitPoint" is shown on the display.

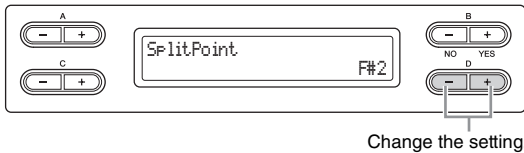

Setting range:

A -1 - C7

Default setting:

F#2

Assigning the SONG [PLAY/PAUSE] function to the pedal

PedalPlay/Pause

NOTE

If you assign the SONG PLAY/PAUSE function to a pedal and turn the function On, the pedal function assigned to the pedal in the Function menu (page 65) is disabled.

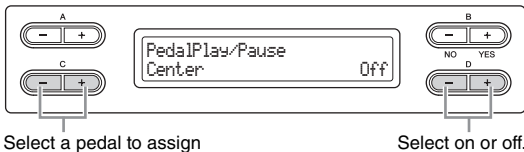

Setting for:

Left, Center, AUX

Setting range:

On/Off

Default setting:

Off for all pedals

Selecting a type of auxiliary pedal

AuxPedalType

A pedal connected to the [AUX PEDAL] jack may switch on and off differently. For example, some pedals turn on the effects and others turn them off when you press them. Use this parameter to reverse this mechanism.

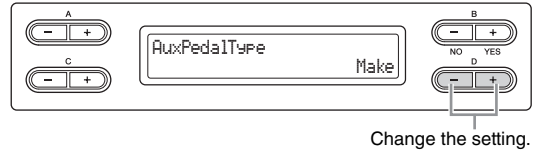

Setting range:

Make, Break

Default setting:

Make

Setting the point at which the damper pedal starts to affect the sound

HalfPedalPoint

Here you can specify the point to which you must depress the pedal (right and AUX) before the assigned effect begins to be applied. This setting applies only to the "SustainCont" effect (page 65) that is assigned to the right or AUX pedal.

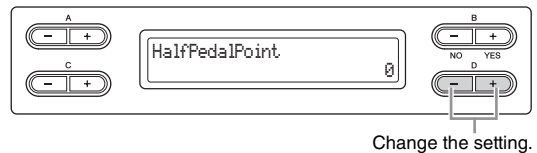

Setting range:

-2 (effective with the shallowest press) - 0 - +4 (effective with the deepest press)

Default setting:

0

Adjusting the depth of the Soft pedal

SoftPedalDepth

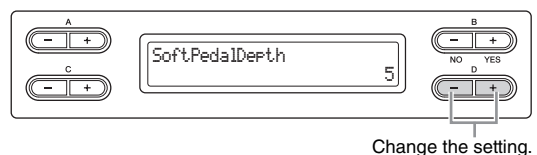

Setting range:

1 - 10

Default setting:

5

Setting the depth of String Resonance

StringResonanceDepth

This parameter is effective on the Grand Piano Voices. For details about the Voices to which the string resonance can be applied, refer to page 75.

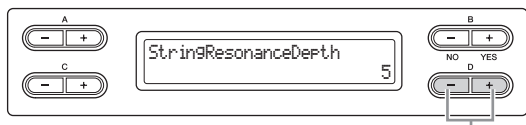

Change the setting.

Setting range:

Off, 1 – 10

Default setting:

5

Setting the depth of Sustain Sampling for the damper pedal

SustainSamplingDepth

This parameter is effective on some of the Grand Piano Voices. For details about the Grand Piano Voices to which Sustain Sampling can be applied, refer to page 75.

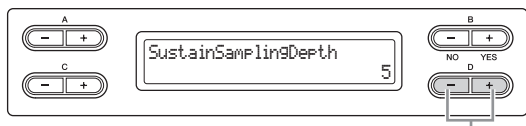

Change the setting.

Setting range:

Off, 1 – 10

Default setting:

5

Specifying the volume of the key-off sound

KeyOffSamplingDepth

You can adjust the volume of the key-off sound (the subtle sound that occurs when you release a key. This is effective on the Voices in the [GRAND PIANO1 – 3], [E.PIANO2] and [HARPSICHORD].

For details about the Voices to which the Key-Off Sampling can be applied, refer to page 75.

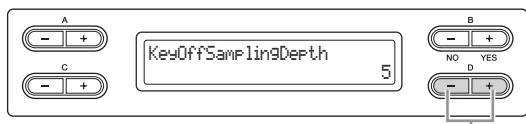

Change the setting.

Setting range:

Off, 1 – 10

Default setting:

5

Setting the range of pitch bend

PitchBendRange

This specifies the amount of change that can be produced by the pitch bend function which smoothly varies the pitch.

- This setting applies only to the manually-played sound.
- This setting can be made in semitone steps.
- You can set the pedal function (page 65) to determine whether the pitch will be raised or lowered.

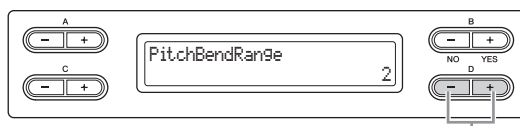

Change the setting.

Setting range:

0 – +12 (Pressing the pedal will raise/lower the pitch by 12 semitones [1 octave])

Default setting:

2

NOTE

For some Piano and Harpsichord Voices, the pitch may not be changed according to the pitch bend setting range here.

Switching the speaker on/off

Speaker

This setting lets you switch the speaker on/off.

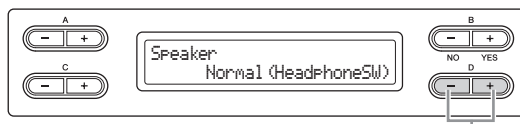

Change the setting.

Setting range:

- **Normal (HeadphoneSW)**
The speaker will sound only if headphones are not connected.
- **On**
The speaker will always sound.
- **Off**
The speaker will not sound.

Default setting:

Normal (HeadphoneSW)

Setting the MIDI transmit channel

MidiOutChannel

This parameter enables you to specify the channel on which the Clavinova transmits MIDI data.

Select the data to be transmitted.

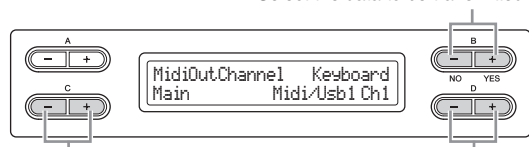

Select a Voice part.

Specify the channel.

Setting for:

Main, Left, Layer, Left Layer

Setting range:

Midi/Usb1 Ch1 – Ch16, Off (Not transmitted.)

Default setting:

MainMidi/Usb1 Ch1
 Left.....Midi/Usb1 Ch2
 M.LMidi/Usb1 Ch3
 L.L.....Midi/Usb1 Ch4

Selecting performance from the keyboard or Song data for MIDI transmission

This display also lets you select the keyboard performance or Song playback as transmission data.

Setting range:

- **Keyboard**
Transmits the MIDI messages generated via your keyboard performance.
- **Song**
Transmits the MIDI messages generated via Song playback.

Default setting:

Keyboard

Setting the MIDI receive channel

MidiInChannel

You can specify whether each channel of data from MIDI [IN] and USB [TO HOST] will be received.

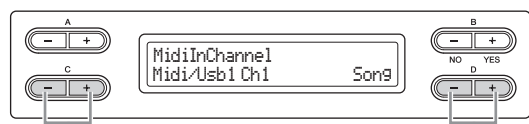

Select a channel.

Select a MIDI receive part.

Setting for:

- **Midi/Usb1 Ch1 – 16**
- **Usb2 Ch1 – 16**

Setting range:

Song, Main, Left, M.L. (Main Layer), L.L. (Left Layer), Keyboard, Off

Default setting:

Midi/Usb1 Ch1 – Ch16.....Song
 Usb2 Ch1.....Keyboard
 Usb2 Ch2.....Main
 Usb2 Ch3.....Left
 Usb2 Ch4.....Layer
 Usb2 Ch5.....LeftLayer
 OthersOff

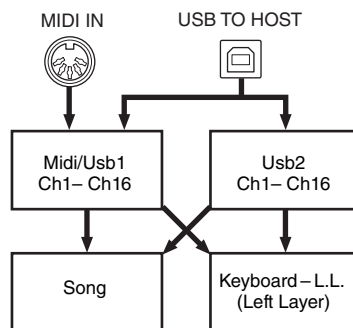

Turning Local Control on/off

LocalControl

“Local Control On” is a state in which the Clavinova produces the sound from its tone generator when you play the keyboard. In “Local Control Off” state, the keyboard and the tone generator are cut off from each other. This means that even if you play the keyboard, the Clavinova will not produce the sound. Instead, the keyboard data can be transmitted via MIDI to a connected MIDI device, which can produce the sound. The “Local Control Off” setting is useful when you wish to play an external sound source while playing the keys on the Clavinova.

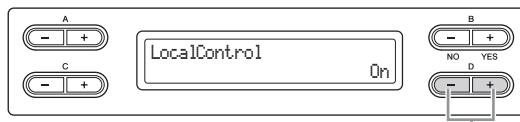

Select on or off.

Setting range:

On/Off

Default setting:

On

Selecting the type of data received via MIDI

ReceiveParameter

This parameter enables you to specify which MIDI data the Clavinova can receive.

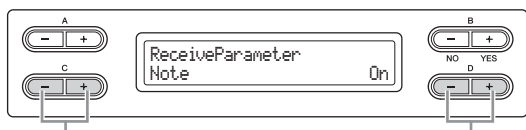

Select a type of data.

Select on or off.

Type of data:

Note, Control (Control Change), Program (Program Change), Pitch Bend, SysEx (System Exclusive)

Setting range:

On/Off

Default setting:

On for all types of data

Selecting the type of data transmitted via MIDI

TransmitParameter

This parameter enables you to specify which MIDI data the Clavinova can transmit.

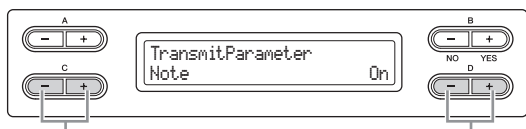

Select a type of data.

Select on or off.

Type of data:

Note, Control (Control Change), Program (Program Change), Pitch Bend, SystemRealTime, SysEx (System Exclusive)

Setting range:

On/Off

Default setting:

On for all types of data

Transmitting the initial settings on the panel

InitialSetup

You can transmit the panel data, such as Voice selection, to a connected sequencer. Before you record performance data to a sequencer, it is useful if you first send and record (at the beginning of the performance data) the panel setup data for your performance during playback.

Start transmission.

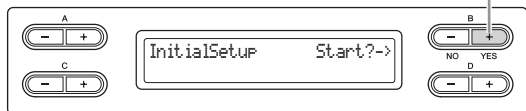

Press the B [+ (YES)] button to call up "Sure?->". Press the B [+ (YES)] button again to start actual transmission.

Selecting items saved at shutdown

MemoryBackup

You can back up some settings, such as Voice selection and metronome setting, so that they will not be lost after you turn off the power to the Clavinova. Memory Songs (saved in the Clavinova's memory), the backup on/off setting (this parameter setting), and the "CharacterCode" parameter setting (page 48) are always backed up.

NOTICE

It takes a few seconds to save the settings. If you turn off the power of the instrument right after changing the setting, the setting may not be saved.

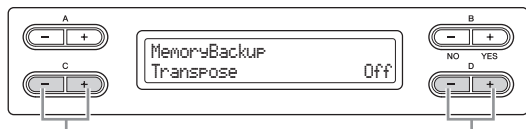

Select the desired item.

Select on or off.

Setting for:

- Transpose
- Brilliance
- ReverbOnOff
- SoundSetting (for the I.A. Control and GP Soundboard Speaker)
- SplitPoint
- Main/LeftVoice
- MetronomeSetting
- File/SongSetting
- MidiSetting ("MidiOutChannel" - "TransmitParameter" in the Function settings)
- Function (except for Transpose, SplitPoint and Midi settings).

Setting range:

On/Off

Default setting:

The Transpose, Main/LeftVoice, MetronomeSetting, and Function parameters are set to Off. Other parameters are set to On.

Restoring the factory default settings

FactorySet

You can reset the Clavinova to its factory default settings.

- The CharacterCode parameter setting does not change.
- The MemoryBackup parameter setting (On/Off) (left column) is reset to the default setting.
- You can select whether the "Memory Songs" (Songs in the MEMORY drive) are erased or kept.

NOTE

The "Default setting" refers to the initial setting preprogrammed when shipped from the factory, called up when you first turn on the power to this instrument.

NOTICE

Do not turn off the power during factory set. Doing so could result in damage to the data.

Execute the Factory Set.

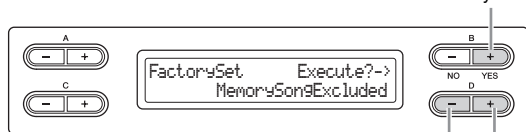

Select whether the Songs in the MEMORY drive are erased or kept.

Settings for “MemorySong”:

MemorySongExcluded..... Memory Songs are kept.
MemorySongIncluded..... Memory Songs are erased.

Alternate method for restoring the default settings

Press and hold down the white key on the right end (C7) and press the [⏻] (Power) switch to turn on the power to the Clavinova. In this case, the Memory Songs (Songs in the MEMORY drive) are not erased.

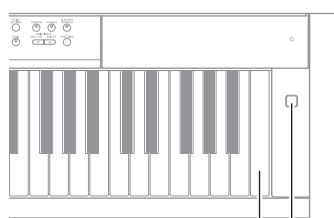

C7
Power switch

Saving/Loading backup file for internal data

FullBackup

From this display, you can save data on internal memory to the connected USB storage device as a backup file (named “clp-480.bup”). The backup file (clp-480.bup) can be loaded to the instrument on this display. Before executing this function, make sure to connect the USB storage device.

Execute the Full Backup.

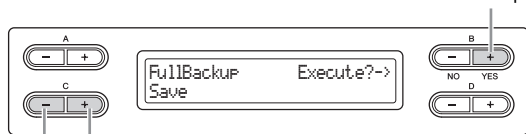

Select “Save” or “Load.”

Use the C [-][+] buttons to select “Save” or “Load” then press the B [+ (YES)] button to execute the Save or Load operation.

NOTICE

- It may take 1 – 2 minutes to complete the backup. Do not turn off the power during full backup. Doing so could result in damage to the data.
- If the backup file (clp-480.bup) is already saved in the USB storage device, the Save operation will overwrite or replace this file with new one.
- Protected Songs (indicated by MS/Ms in the display) cannot be backed up. Move such Songs to the USB storage device before executing Full Backup by following the instructions page 45. If you do not, the Protected Songs will be deleted when you load the Backup file to this instrument.
- Do not execute “FullBackup” during other file operations. Doing so could result in damage to the data.

NOTE

It is best to connect only a single USB storage device when backing up your data. When several devices are connected, a specific device cannot be identified for saving data.

Appendix

Preset Voice List (Detailed)

O: Yes, —: No

| Voice group | Voice name | Touch Response | Stereo Sampling | Key-off Sampling | Sustain Sampling | String Resonance | Voice description |
|---------------|-------------------|----------------|-----------------|------------------|------------------|------------------|--|
| GRAND PIANO 1 | Grand Piano | O | O | O | O | O | This sound was sampled from a concert grand piano. It uses different samples depending on the strength of your playing and produces smoother tonal changes. Even the tonal changes produced by the damper pedal and the subtle sounds of releasing a key are reproduced. The sympathetic vibration (string resonance) that occurs among the strings of an acoustic piano has also been simulated. Suitable not only for classical compositions but also for piano pieces of any style. |
| | Ballad Grand | O | O | O | O | O | Standard piano with a soft and warm tone. Good for playing ballads. |
| | Rock Piano | O | O | O | O | O | A bright-sounding piano. Ideal for rock styles. |
| | HonkyTonk Piano | O | O | O | O | — | A honky-tonk style piano. Enjoy a tonal character that is quite different than a grand piano. |
| GRAND PIANO 2 | Mellow Grand | O | O | O | — | O | Mellow piano sound with gradual attack. Good for quiet and slow music. |
| | Warm Grand | O | O | O | O | O | Warm and soft piano sound. Good for relaxing music. |
| GRAND PIANO 3 | Bright Grand | O | O | O | O | O | Bright piano sound. Good for clear expression and "cutting through" other instruments in an ensemble. |
| | Pop Grand | O | O | O | O | O | A slightly brighter piano sound than the Grand Piano. Good for popular styles. |
| GRAND PIANO 4 | Live Grand | O | O | — | — | — | Spacious and clear piano with bright reverb. Good for popular music. |
| | Dynamic Grand | O | O | O | O | — | A solid, bass-heavy piano sound. Good for making your performance more dynamic. |
| E.PIANO 1 | DX E.Piano | O | — | — | — | — | An electronic piano sound produced by an FM synthesizer. The tone will change as you vary your playing touch. Ideal for popular music. |
| | Synth Piano | O | — | — | — | — | This Voice simulates the electric piano sound produced by synthesizers in popular music. It also goes well with the acoustic piano sound. |
| E.PIANO 2 | Stage E.Piano | O | — | O | — | — | The sound of an electric piano using hammerstruck metallic "tines." Soft tone when played lightly, and an aggressive tone when played hard. |
| | Vintage E.Piano | O | — | — | — | — | A different type of electric piano sound. Widely used in rock and popular music. |
| HARPSICHORD | Harpsichord 8' | — | O | O | — | — | The sound of the instrument frequently used in baroque music. Variations in playing touch will not affect the volume, and a characteristic sound will be heard when you release the key. |
| | Harpsichord 8'+4' | — | O | O | — | — | A harpsichord with an added upper octave. Produces a more brilliant sound. |

| Voice group | Voice name | Touch Response | Stereo Sampling | Key-off Sampling | Sustain Sampling | String Resonance | Voice description |
|-------------|----------------------|----------------|-----------------|------------------|------------------|------------------|---|
| VIBRAPHONE | Vibraphone | ○ | ○ | — | — | — | Vibraphone played with relatively soft mallets. The tone becomes more metallic the harder you play. |
| | Marimba | ○ | ○ | — | — | — | A marimba sound, sampled in stereo for spaciousness and realism. |
| | Celesta | ○ | ○ | — | — | — | The sound of a celesta (a percussion instrument in which hammers strike metallic bars to produce sound). This instrument is well-known for its appearance in "Dance of the Sugar-plum Fairies" from Tchaikovsky's "Nutcracker Suite." |
| PIPE ORGAN | Pipe Organ Principal | — | ○ | — | — | — | This Voice features the combination of pipes (8'+4'+2') of a principal (brass instrument) organ. It is suitable for Baroque church music. |
| | Pipe Organ Tutti | — | ○ | — | — | — | This Voice features a full coupler of a pipe organ, famous for the sound used in Toccata and Fugue by Bach. |
| | Pipe Organ Flute 1 | — | ○ | — | — | — | A pipe organ sound that combines flute-type (woodwind type) stops of different pitches (8' + 4'). This is a gentle sound that is ideal for accompanying hymns. |
| | Pipe Organ Flute 2 | — | ○ | — | — | — | A pipe organ sound that combines flute-type (woodwind type) stops of different pitches (8' + 4' + 1-1/3'). This is brighter than PipeOrganFlute1, and is suitable for solos. |
| JAZZ ORGAN | Jazz Organ | — | — | — | — | — | The sound of a "tonewheel" type electric organ. Often heard in jazz and rock idioms. |
| | Rotary Organ | — | — | — | — | — | A bright electric organ sound. |
| | Mellow Organ | — | — | — | — | — | A mellow electric organ sound. Ideal for calmer songs. |
| STRINGS | Strings | ○ | ○ | — | — | — | Stereo-sampled, large-scale strings ensemble with realistic reverb. Try combining this Voice with acoustic piano in the Dual mode. |
| | Synth Strings | ○ | — | — | — | — | A bright and spacious strings sound. Suitable for sustained parts in the background of an ensemble. |
| | Slow Strings | ○ | ○ | — | — | — | The sound of a string ensemble, with a slow attack. Suitable for use in Dual mode with GRAND PIANO or E.PIANO. |
| CHOIR | Choir | ○ | — | — | — | — | A big, spacious choir Voice. Perfect for creating rich harmonies in slow pieces. |
| | Slow Choir | ○ | — | — | — | — | The sound of a choir with a slow attack. Suitable for use in Dual mode with GRAND PIANO or E.PIANO. |
| | Scat | ○ | — | — | — | — | You can enjoy jazz "scatting" with this Voice. Depending on how hard and what note range you play, different sounds will be produced. |
| SYNTH.PAD | Synth Pad 1 | ○ | — | — | — | — | A warm, mellow, and spacious synth sound. Ideal for sustained parts in the background of an ensemble. |
| | Synth Pad 2 | ○ | — | — | — | — | A clear and spacious synth sound. Ideal for sustained parts in the background of an ensemble. |
| GUITAR | Nylon Guitar | ○ | ○ | — | — | — | Stereo-sampled, nylon-string guitar with natural reality. Suitable for any style of musics. |
| | Steel Guitar | ○ | — | — | — | — | A bright steel guitar sound. Ideal for popular music. |

| Voice group | Voice name | Touch Response | Stereo Sampling | Key-off Sampling | Sustain Sampling | String Resonance | Voice description |
|-------------|---------------|----------------|-----------------|------------------|------------------|------------------|--|
| BASS | Wood Bass | ○ | — | — | — | — | The sound of a finger-plucked upright bass. Frequently used in jazz and Latin music. |
| | Bass & Cymbal | ○ | — | — | — | — | The sound of a cymbal has been layered onto the bass. Effective when used for jazz walking-bass lines. |
| | Electric Bass | ○ | — | — | — | — | The sound of an electric bass. Frequently used in jazz, rock, and popular music. |
| | Fretless Bass | ○ | — | — | — | — | The sound of a fretless bass. Suitable for styles such as jazz and fusion. |

Key-Off Sampling:

Samples of the very delicate noises that are produced when keys are released

Sustain Sampling:

Samples of the resonance of the soundboard and strings when the damper pedal is pressed.

String Resonance:

Simulated string resonance sound.

Message List

| Message | Meaning |
|---|---|
| Access error | The operation has failed. The following causes can be considered. If the following are not responsible, the file may be damaged. <ul style="list-style-type: none"> • The file operation is wrong. Follow the instructions in "Handling Song files" (page 41) or "Saving/ Loading the Backup file for internal data" (page 74). • The connected USB storage device is not compatible with this instrument. For information on compatible USB storage devices, see page 51. • The protected Song on which you attempted the operation is defective. |
| Canceled | This message indicates that the operation has been cancelled. |
| Cannot be executed | The operation has failed. The following causes can be considered. Solve the causes, and try again. <ul style="list-style-type: none"> • The file operation you attempted cannot be executed to Preset Songs and folders. For information on the limitation of handling Song files, see page 41. • The Song file operation cannot be made to drives, an empty Song file (page 34) or NoSong. NoSong: This is displayed when you select a drive which contains no song. |
| Completed | This message indicates that the operation is completed. Go on to the next step. |
| Convert to?-> | This message prompts you to select the Convert destination. Follow the instructions in "Converting a MIDI Song to an Audio Song during playback" on page 46. |
| Copy to?-> | This message prompts you to select the Copy destination. Follow the instructions in "Copying files" on page 44. |
| Device (media) busy | The operation, such as converting to the Audio Song or Audio Song playback/recording, has failed. This message appears when you attempt to use a USB storage device to which recording/deleting operations are repeated. Execute the Format operation after making sure there is no important data in the USB storage device (page 46), and try again. |
| Device (media) removed | This message appears when the USB storage device is removed from the instrument. |
| Duplicate name | This message indicates that an identically-named file already exists. Rename the file (page 43). |
| Execute?-> | This message prompts you to execute the operation. Press the B [+ (YES)] button to proceed, or press the [EXIT] button to cancel. |
| Executing | The instrument is executing the operation. Wait until the message disappears, then go on to the next step. |
| Factory set executing Memory Song excluded | The default settings (except the Songs in the MEMORY drive) have been restored (page 73). This message also appears if you press and hold down the C7 and turn on the power to the instrument. |
| Factory set executing Memory Song included | The default settings (including the Songs in the MEMORY drive) have been restored (page 73). |
| FactorySet Completed Restart | Factory set is completed. The instrument is then restarted. |
| Files still in folder | The file(s) exists in the folder which you have attempted to delete. Only folders that contain no files can be deleted; folders containing a file or files cannot be deleted. |
| FullBackup Completed Restart | Loading of the backup file is completed. The instrument is then restarted. |
| Incompatible device | This message appears when an incompatible USB storage device is connected. Use a device whose compatibility has been confirmed by Yamaha (page 51). |
| Internal hardware error | A malfunction has occurred in the instrument. Contact your nearest Yamaha dealer or authorized distributor. |
| Last power off invalid Checking memory | This message appears when the power is turned on after turning off the power while handling a Song file (page 41) or saving a backup file (page 74). The internal memory is being checked while this message appears. If the internal settings are damaged, they will be reset to the default settings. If the Songs in the MEMORY drive are damaged, they will be deleted. |

| Message | Meaning |
|--|---|
| Maximum no. of devices exceeded | The number of USB storage devices exceeds the limitation. Up to two USB storage devices can be connected simultaneously. For details, see page 51. |
| Memory full | Since the capacity and the number of files of MEMORY drive/USB storage device are full, the operation cannot be made. Delete some Songs in the MEMORY drive/USB storage device or move Songs to another USB storage device, and try again. |
| Move to?-> | This message prompts you to select the Move destination. Follow the instructions in "Moving files" on page 45. |
| Name?-> | This message prompts you to change the name of the Song/folder which is currently displayed. Follow the instructions in "Renaming files" (page 43) or "Making folders in the USB storage device" (page 45) to change the name, or press the B [- (NO)] button to cancel. |
| No device | A USB storage device was not connected to the instrument when you attempted to perform a device-related operation. Connect the device, and try again. |
| No device (media) | No media is not has been inserted to the selected USB storage device. Insert the media. |
| No file | This message appears when there is no backup file to load in the connected USB storage device. |
| No response from USB device | The instrument cannot communicate with the connected USB device. Redo the connection (page 51). If you still see this message, the USB device may be damaged. |
| Notice: Protected Song | This message appears when you attempt to handle the Protected Song. For information on the limitation of file operations, see page 41. |
| Overwrite?-> | The file already exists. This message prompts you to overwrite the existing data with new data. Press the B [+ (YES)] button to proceed, or press the B [- (NO)] button to cancel. |
| Please wait | The instrument is processing the data. Wait until the message disappears, then go on to the next step. |
| Protected device (media) | This message appears when you attempt a file operation (page 41), record your performance or save the data on a read-only USB storage device. Cancel the read-only setting, if possible, and try again. If you still see this message, the USB storage device is internally protected (such as commercially available music data). You cannot make the file operation or record your performance to such a device. |
| Protected Song | You attempted a file operation to a Protected Song or read-only file. Data of those types have handling limitations (page 41), and also cannot be used for editing (page 37). Use a read-only file after cancelling the read-only setting. |
| Remaining space on drive is low | Since the remaining space on the MEMORY drive/USB storage device is low, delete any unnecessary files (page 43) before recording. |
| Selected drive?-> | This message prompts you for confirmation to continue the operation with the currently selected USB storage device. Press the Press the B [+ (YES)] button to proceed, or press the B [- (NO)] button to cancel. |
| Set?-> | This message prompts you to save the settings. Press the B [+ (YES)] button to save, or press the [EXIT] button to cancel. |
| Song error | This message appears, if a problem is found with the Song data when you select a Song or while the Song is playing. In this case, reselect the Song, and try again to play back. If the message still appears, the Song data may have been damaged. |
| Song too large | The size of Song data (MIDI/Audio) exceeds the limitation. The following causes can be considered. <ul style="list-style-type: none"> • The Song size you attempt to play back exceeds the limitation. The limitation for playback is approx. 550KB (MIDI), 80 minutes (Audio). • The Song size exceeds the limitation during recording. The limitation for recording is approx. 550KB (MIDI), 80 minutes (Audio). The recording will end automatically and the recording data before the end is saved. • The Song size exceeds the limitation during converting a MIDI Song to an Audio Song. The limitation is 80 minutes (Audio). |
| Start?-> | This message prompts you to start the operation. Press the B [+ (YES)] button to start, or press the [EXIT] button to cancel. |
| Sure?-> | This message prompts you for confirmation of the operation. Press the B [+ (YES)] button to execute, or press the B [- (NO)] button to cancel. |

| Message | Meaning |
|---------------------------------------|---|
| System limit | This message appears when the number of files and folders exceeds the system limit. The maximum number of files/folders which can be saved in a folder is 250. Try again after deleting/moving the unnecessary file(s). |
| Unformatted device (media) | This message appears when you attempt to use an unformatted USB storage device. Format it (page 46), and try again. |
| Unsupported device | This message appears when an unsupported USB storage device is connected. Use a device whose compatibility has been confirmed by Yamaha (page 51). |
| USB device overcurrent error | Communication with the USB device has been cut off because of an abnormal power surge to the device. Disconnect the USB device from the [USB TO DEVICE] terminal and turn the power switch of the instrument off and on again. |
| USB hub hierarchical error | The USB hub is connected in two layers. USB hub use is limited to one layer. |
| USB power consumption exceeded | The power consumption of the connected USB device exceeds the predetermined value. This message appears when a bus-powered USB hub is used. The USB hub must be self powered (with its own source) and the power must be on. |
| Wrong device | <p>The file operation cannot be made to the connected USB storage device. The following causes can be considered.</p> <ul style="list-style-type: none"> • The USB storage device is not formatted. Format it (page 46), and try again. • The number of files and folders exceeds the system limit. The maximum number of files/folders which can be saved in a folder is 250. Try again after deleting/moving the unnecessary file(s). • The media is not inserted. Insert the media. |
| Wrong name | <p>The Song name is not appropriate. This message appears during the "Renaming files" (page 43) or "Making folders" (page 45) operation because of the following causes. Press the B [- (NO)] button to return to the previous display, and rename the Song correctly.</p> <ul style="list-style-type: none"> • No character has been input. • You used a period or space at the beginning/ending of a Song name. |
| Wrong selection | The file operation you attempted cannot be executed to the selected drive. For information on the limitations of handling Song files, see page 41. |

Troubleshooting

When a message is displayed, refer to the “Message List” (page 78) for troubleshooting aid.

| Problem | Possible Cause and Solution |
|---|---|
| The instrument does not turn on. | The instrument has not been plugged in properly. Securely insert the female plug into the socket on the instrument, and the male plug into a proper AC outlet (page 12). |
| A click or pop is heard when the power is turned on or off. | This is normal when electrical current is being applied to the instrument. |
| Noise is heard from the speakers or headphones. | The noise may be due to interference caused by the use of a mobile phone in close proximity to the instrument. Turn off the mobile phone, or use it further away from the instrument. |
| The overall volume is low, or no sound is heard. | The Master Volume is set too low; set it to an appropriate level using the [MASTER VOLUME] dial (page 14). |
| | The volume level for the keyboard performance is set too low. Move the [SONG BALANCE] slider toward “KEYBOARD” to increase the keyboard volume (page 40). |
| | Headphones are connected when the Speaker setting is “Normal (HeadphoneSW)” (page 71). Disconnect the headphone plug. |
| | Speaker setting is “Off.” Set the Speaker to “Normal (HeadphoneSW)” or “On” (page 71). |
| | Local Control is “Off.” Set Local Control “On” (page 72). |
| | “Expression” is assigned to the right pedal or the AUX pedal. Assign any function other than “Expression” to the pedal (page 65). |
| The speakers do not switch off when a pair of headphones is connected to the [PHONES] jack. | Speaker setting is “On.” Set the speaker setting to “Normal (HeadphoneSW)” (page 71). |
| The tone quality and/or volume from the speakers or headphones has changed. | The sound condition output from the internal speakers and the headphones changes automatically to the appropriate settings depending on how the external device is connected to the AUX OUT jacks. See chart on page 50. |
| Pedals do not function. | The pedal cord may not be securely connected to the [PEDAL] jack. Be sure to insert the pedal cord all the way until the metal part of the cord plug disappears from view (page 85). |
| The on/off setting of the pedal connected to the AUX PEDAL jack is reversed. | Some types of pedals may turn on and off in opposite fashion. Use the “AuxPedalType” parameter (page 70) in the “FUNCTION” menu to change the external pedal setting. |
| The keyboard volume is lower than the Song playback volume. | The volume level for the keyboard performance is set too low. Move the [SONG BALANCE] slider toward “KEYBOARD” to increase the keyboard volume (page 40). |
| The buttons do not respond. | While you are using a function, some buttons not used for the function are disabled. If the Song is playing, stop playback. Otherwise, press the [EXIT] button to return to the Voice display. Then, perform the desired operation. |
| Higher or lower notes do not sound correctly when the transpose or octave setting is made. | This instrument can cover the range of C -2 – G8 when you set the transposition or octave. If notes lower than C -2 are played, the sound is moved one octave higher. If notes higher than G8 are played, the sound is moved one octave lower. |
| Performance in Dual or Split mode is not recorded, or part data is lost unexpectedly. | Switching to Dual mode or Split mode in the middle of the Song is not recorded. Also, the recording part for the Voice 2 (Dual mode) or the left-hand Voice (Split mode) is automatically assigned (page 40). If the assigned part already has data, the data will be overwritten and deleted when you record. |
| The Song title is not correct. | The “CharacterCode” setting may be different than that is selected when you named the Song. Also, if the Song was recorded on another instrument, the title might be displayed incorrectly. Use the “CharacterCode” parameter (page 48) in the [FILE/SONG SETTING] menu to change the setting. However, if the Song was recorded on another instrument, changing the “CharacterCode” parameter setting may not resolve the problem. |

Assembling the Clavinova

⚠ CAUTION

- Be careful not to confuse parts, and be sure to install all parts in the correct direction. Please assemble in accordance with the sequence given below.
- Assembly should be carried out by at least two persons.
- Be sure to use the correct screw size, as indicated below. Use of incorrect screws can cause damage.
- Assemble the unit on a hard and flat floor with ample space.
- Be sure to tighten up all screws upon completing assembly of each unit.
- To disassemble, reverse the assembly sequence given below.

Have a Philips-head (+) screwdriver of the appropriate size ready.

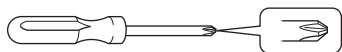

Remove all parts from the package and make sure you have all of the items.

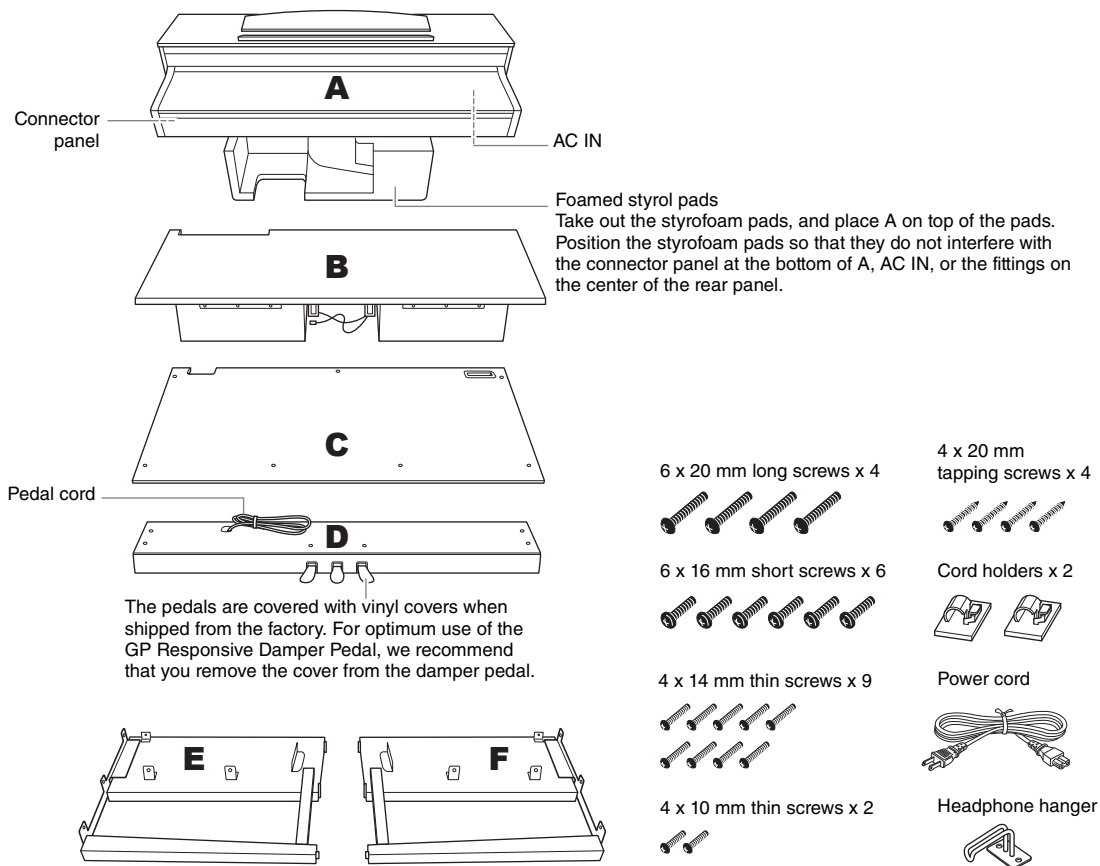

1. Attach E and F to D.

1-1 Secure D using the four 6 x 20 mm long screws.

1-2 Remove the twist tie from the folded pedal cord.

Do not remove the twist tie located next to the hole. Don't discard the twist tie, you'll need it later in step 6.

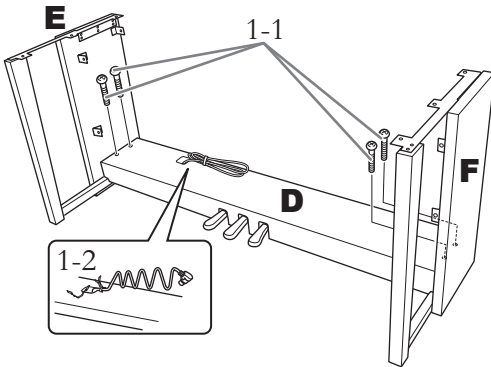

2. Attach B.

2-1 Insert B between E and F as shown in the illustration.

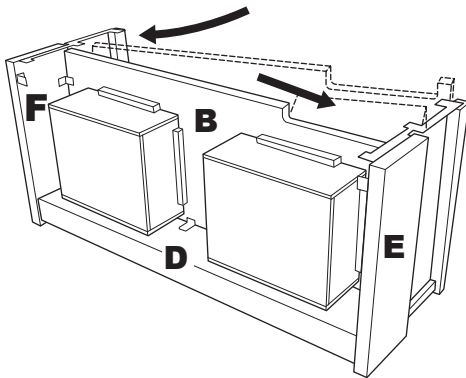

2-2 Align and attach B to the front side of D, E and F.

2-3 Secure B using the 4 x 14mm thin screws.

* Insert two screws into the smaller holes on the brackets.

2-4 Temporarily secure with 4 x 14mm thin screws.

* Insert four screws into the smaller holes on the brackets.

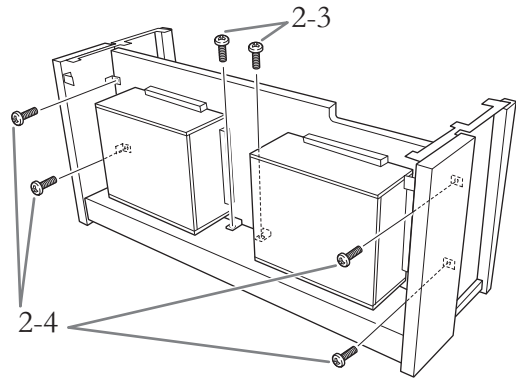

3. Lay A into position.

Align the screw threads on the bottom of A with the screw threads of E and F, while gently lowering A into position.

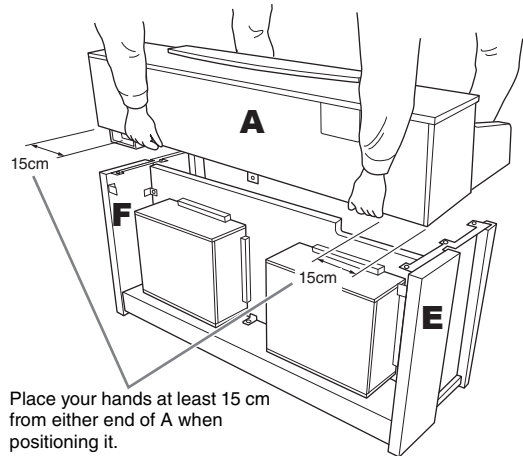

Place your hands at least 15 cm from either end of A when positioning it.

⚠ CAUTION

- Be extra careful not to drop or let your fingers be pinched by the main unit.
- Do not hold the main unit in any position other than the position specified above.

4. Attach A.

- 4-1 Adjust the position of A so that the left and right ends of A will project beyond E and F equally (as seen from the rear).
- 4-2 Secure A using two 6 x 16mm short screws from the rear.
- 4-3 Secure A using four 6 x 16mm short screws from the front.

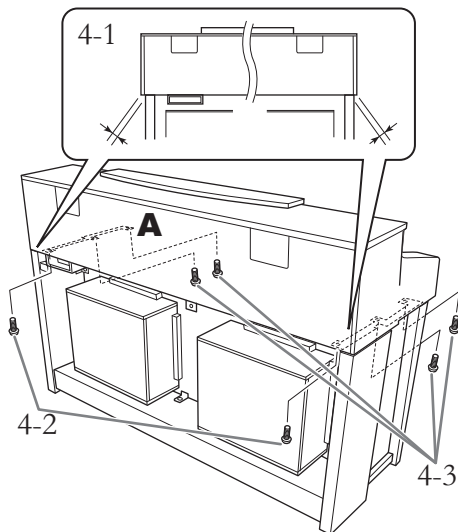

- 4-4 Firmly tighten the screws from the upper parts you temporarily fastened in step 2-4 (assembly B).

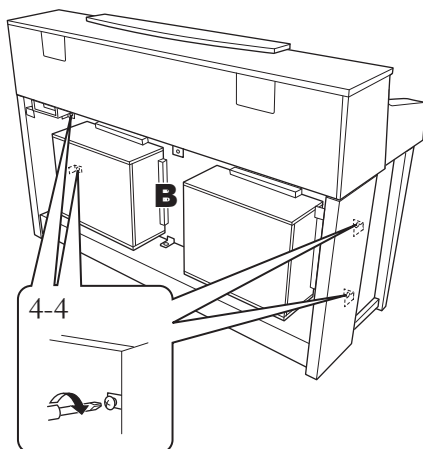

5. Connect the speaker cord.

- 5-1 Remove the twist tie attaching the speaker cord.
- 5-2 Insert the speaker cord plug into the connector so that the tab extends toward the front when viewed from the rear.

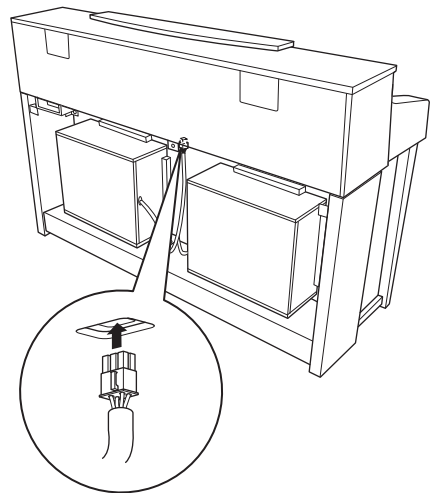

6. Connect the pedal cord.

- 6-1 Insert the pedal cord plug into the [PEDAL] connector.
- 6-2 Attach the cord holders to the instrument, then clip the cord into the holders. At this time, be careful that the pedal cord isn't loose between the plug and cord holder.
- 6-3 Use a twist tie to bundle the pedal cord.

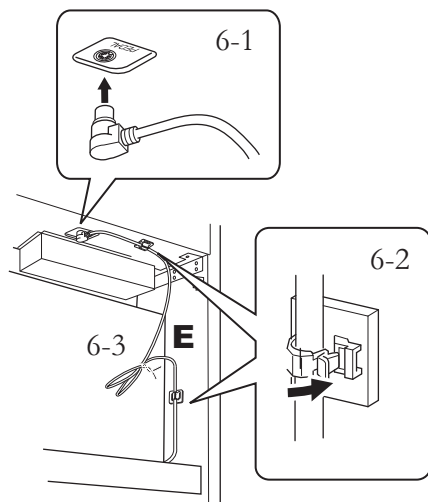

Insert the pedal cord securely until the metal part of the cord plug disappears from view. Otherwise, the pedal may not function properly.



7. Attach C.

- 7-1 Place on D, the stopper-wood at the bottom edges of C, then secure the top.
- 7-2 Secure the upper right, left, and center parts of C using three 4 x 14 mm thin screws.
- 7-3 Secure the lower part of C using four 4 x 20 mm tapping screws.

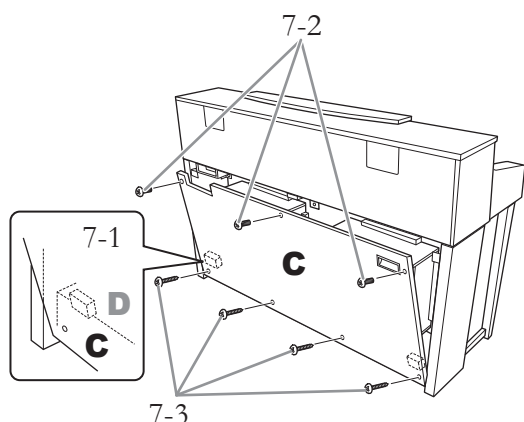

8. Connect the power cord.

- 8-1 For models that feature a voltage selector: Set the voltage selector to an appropriate voltage.

Voltage Selector

Before connecting the AC power cord, check the setting of the voltage selector which is provided in some areas. To set the selector for 110V, 127V, 220V or 240V main voltages, use a “minus” screwdriver to rotate the selector dial so that the correct voltage for your region appears next to the pointer on the panel. The voltage selector is set at 240V when the unit is initially shipped. After the proper voltage has been selected, connect the AC power cord to the AC IN and an AC wall outlet. A plug adaptor may be also provided in some areas to match the pin configuration of the AC wall outlets in your area.

⚠ WARNING

An improper voltage setting can cause serious damage to the instrument or result in improper operation.

- 8-2 Insert the plug of the power cord into the power connector.

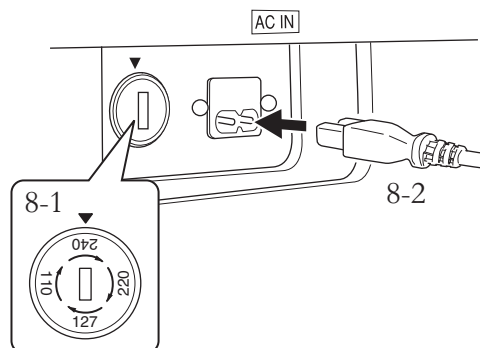

9. Set the adjuster.

Rotate the adjuster until the pedal box comes in firm contact with the floor surface.

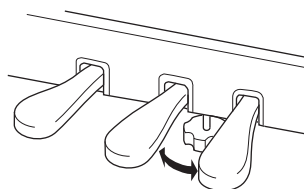

10. Attach the headphone hanger.

Use the included two screws (4 x 10 mm) to attach the hanger as shown in the illustration.

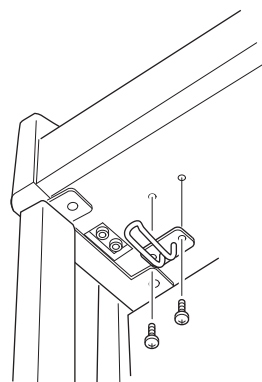

After completing the assembly, please check the following.

- **Are there any parts left over?**
Review the assembly procedure and correct any errors.
- **Is the instrument clear of doors and other movable fixtures?**
Move the instrument to an appropriate location.
- **Does the instrument make a rattling noise when you shake it?**
Tighten all screws.
- **Does the pedal box rattle or give way when you step on the pedals?**
Turn the adjuster so that it is set firmly against the floor.
- **Are the pedal and power cords inserted securely into the sockets?**
Check the connection.
- **If the unit creaks or is otherwise unsteady when you play on the keyboard, refer to the assembly diagrams and retighten all screws.**

After transporting the instrument, place the instrument so that the rear side of the instrument is 1–2cm away from the wall to ensure optimum performance of the GP Soundboard Speaker function (page 15).

⚠ CAUTION

- When moving the instrument after assembly, always hold instrument by the lower surface in the front of the main unit and by the handles in the rear panel.
- Do not hold the key cover. Improper handling can result in damage to the instrument or personal injury.

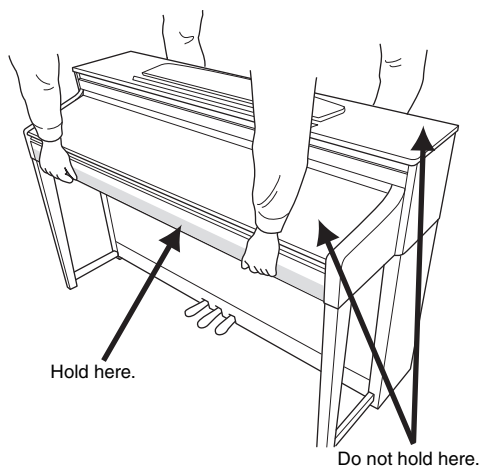

Specifications

| | | | |
|--------------------------|---|---|--|
| Size/Weight | Dimensions | Width [in the case of a model with a polished finish] | 1420mm (55-15/16") [1424mm] (56-1/16") |
| | | Height [in the case of a model with a polished finish] | 940mm (37") [943mm] (37-1/8") |
| | | Height with music rest [in the case of a model with a polished finish] | 1108mm (43-5/8") [1109mm] (43-11/16") |
| | | Depth [in the case of a model with a polished finish] | 513mm (20-3/16") [513mm] (20-3/16") |
| | Weight [in the case of a model with a polished finish] | 87.5kg (192lbs., 14oz.) [91.0kg] (200lbs., 10oz.) | |
| Control Interface | Keyboard | Number of Keys | 88 |
| | | Type | NW (Natural Wood) with Synthetic ivory keytops (with real-wood white keys) |
| | | Linear Graded Hammer | Yes |
| | | Touch Sensitivity | Yes |
| | Pedal | Number of Pedals | 3 (Damper, Sostenuto, Soft) |
| | | Half Pedal | Yes (Damper) |
| | | GP Responsive Damper Pedal | Yes |
| | Display | Type | Backlit LCD (24-character x 2-line) |
| | | Contrast | Yes |
| | | Color | Monochrome |
| | | Language | English, Japanese |
| | Panel | Language | English |
| | Cabinet | Key Cover Style | |
| Music Rest | | Yes | |
| Music Braces | | Yes | |
| Voices | Tone Generation | Tone Generation Technology | Real Grand Expression (RGE) |
| | Piano Tone Generation Effects | Smooth Release | Yes |
| | | Sustain Samples | Yes |
| | | Key-off Samples | Yes |
| | | String Resonance | Yes |
| | Polyphony | Number of Polyphony (Max.) | 256 |
| | Preset | Number of Voices | 40 + 480 XG + 12 Drum Kits |
| | Compatibility | XG | Yes |
| GS | | Yes | |
| GM | | Yes | |
| GM2 | | Yes | |
| Effects | Types | Reverb | 5 |
| | | Chorus | 3 |
| | | Brilliance | 7 |
| | | DSP | 12 |
| | | Others | Intelligent Acoustic Control, GP Soundboard Speaker |
| | Functions | Dual/Layers | Yes |
| | | Split | Yes |

| | | | |
|--|------------------------------|---------------------------|---|
| Recording/ Playback (MIDI Songs) | Recording | Number of Songs | 250 (max.) |
| | | Number of Tracks | 16 |
| | | Data Capacity | Approx. 1.5MB (max.) <Approx. 550KB/song (max.)> |
| | Playback | Data Capacity | Approx. 550KB/Song (max.) |
| | Data Format | Recording | SMF (Format 0) |
| | | Playback | SMF (Format 0, Format 1), ESEQ |
| | Data Size | Approx. 550KB/song (max.) | |
| Preset | Number of Preset Songs | 50 | |
| Recording/ Playback (Audio Songs) | Length of Recording/Playback | | 80 minutes/song (max.) |
| | Data Format | | .wav (44.1 kHz sample rate, 16-bit resolution, stereo) |
| Functions | Demo Songs | | Voice Demo: 16 |
| | Overall Controls | Metronome | Yes |
| | | Tempo Range | 5 – 500 |
| | | Transpose | -12 to 0, 0 to +12 |
| | | Tuning | Yes |
| | | Scale Type | 7 types |
| Storage and Connectivity | Storage | Internal Memory | Approx. 1.5MB |
| | | External Device | USB Storage Device (optional) |
| | Connectivity | Headphones | ×2 |
| | | MIDI | [IN][OUT][THRU] |
| | | AUX IN | [L/L+R][R] |
| | | AUX OUT | [L/L+R][R] |
| | | [AUX PEDAL] | Yes |
| | | [USB TO DEVICE] | Yes |
| | | USB [TO HOST] | Yes |
| Amplifiers/ Speakers | Amplifiers | | (30W + 30W + 20W + 20W) × 2 |
| | Speakers | | (16cm + 8cm + 2.5cm) × 2 + 8cm × 2 |
| | Tri-Amp System | | Yes |
| Accessories | Included Accessories | | Owner's Manual, "50 greats for the Piano" (Music Book), Data List, AC Power Cord, Bench (included or optional depending on locale), My Yamaha Product User Registration |

* Specifications and descriptions in this owner's manual are for information purposes only. Yamaha Corp. reserves the right to change or modify products or specifications at any time without prior notice. Since specifications, equipment or options may not be the same in every locale, please check with your Yamaha dealer.

Options (May not be available depending on your particular area.)

BC-100 Bench

A comfortable bench styled to match your Yamaha Clavinova.

HPE-160 Stereo Headphones

High-performance lightweight dynamic headphones with extra-soft ear pads.

Index

A

| | |
|------------------|----|
| A-B Repeat | 32 |
| Assembly | 82 |
| Audio Song | 27 |

B

| | |
|---------------------|----|
| Backup file | 74 |
| Backup on/off | 73 |
| BRILLIANCE | 23 |

C

| | |
|---------------------|----|
| CharacterCode | 48 |
| CHORUS | 23 |
| Computer | 52 |
| Connectors | 49 |
| CONTRAST | 14 |
| Convert | 46 |
| Copy | 44 |

D

| | |
|-----------------------------|--------|
| Damper Resonance | 63 |
| Data Format | 88 |
| Data List | 7 |
| Delete | 43 |
| Demo Song | 21 |
| Display characters | 48 |
| Display messages | 78 |
| Drive (data location) | 28 |
| DriveProperty | 47 |
| Dual | 24, 62 |

E

| | |
|---------------|----|
| Effects | 23 |
|---------------|----|

F

| | |
|--------------------|----|
| Factory Set | 73 |
| Fast forward | 29 |
| Format | 46 |
| FUNCTION | 68 |

G

| | |
|----------------------------------|----|
| GP Responsive Damper Pedal | 16 |
| GP Soundboard Speaker | 15 |

H

| | |
|---------------------------|----|
| Half-pedal | 16 |
| Handling Song files | 41 |
| Headphone hanger | 15 |
| Headphones | 15 |

I

| | |
|------------------------------------|----|
| I.A. CONTROL | 14 |
| Included Accessories | 7 |
| Intelligent Acoustic Control | 14 |

K

| | |
|--|--------|
| Key | 68 |
| Key cover | 12 |
| Key-off sound (Key-Off Sampling) | 71, 77 |

L

| | |
|--------------------------|----|
| Load (backup file) | 74 |
|--------------------------|----|

M

| | |
|-------------------------------------|--------|
| Maintenance | 19 |
| MASTER VOLUME | 14 |
| MEMORY | 28, 41 |
| Message List | 78 |
| Metronome | 17 |
| MID settings → Other settings | 56 |
| MIDI Basics | 7 |
| MIDI Song | 27 |
| MIDItoAUDIO | 46 |
| Move | 45 |
| Music braces | 14 |
| Music rest | 13 |

O

| | |
|------------------------|---|
| Online materials | 7 |
|------------------------|---|

P

| | |
|------------------------|--------|
| Part (recording) | 34 |
| Part Cancel | 31 |
| Pause | 29 |
| Pedal | 16, 70 |
| Piano Demo | 22 |
| Power | 12 |
| PRESET | 28, 41 |
| Preset Song | 41 |

R

| | |
|-----------------------|--------|
| Recorded data | 39 |
| Recording | 33 |
| Rename | 43 |
| Repeat playback | 32, 57 |
| Reset | 18 |
| Restore | 73 |
| REVERB | 23 |
| Rewind | 29 |

Root note69

S

Save (backup file)74

Scale69

Song27

Song Auto Open48

Song file operation41

Song Repeat57

Song types41

Speaker on/off71

Split25

String Resonance 71, 77

Sustain Sampling 71, 77

Sync Start30

T

Tempo (metronome)17

Tempo (Song playback)29

Time signature60

Touch Response68

Transpose68

Troubleshooting81

Tuning69

U

USB AUDIO 28, 41

USB storage device51

USB1 28, 41

V

Voice20

Voice (Dual)24

Voice Demo21

Volume (Dual/Split)61

Volume (Master Volume)14

Volume (metronome)60

Information for Users on Collection and Disposal of Old Equipment



This symbol on the products, packaging, and/or accompanying documents means that used electrical and electronic products should not be mixed with general household waste. For proper treatment, recovery and recycling of old products, please take them to applicable collection points, in accordance with your national legislation and the Directives 2002/96/EC.

By disposing of these products correctly, you will help to save valuable resources and prevent any potential negative effects on human health and the environment which could otherwise arise from inappropriate waste handling.

For more information about collection and recycling of old products, please contact your local municipality, your waste disposal service or the point of sale where you purchased the items.

[For business users in the European Union]

If you wish to discard electrical and electronic equipment, please contact your dealer or supplier for further information.

[Information on Disposal in other Countries outside the European Union]

This symbol is only valid in the European Union. If you wish to discard these items, please contact your local authorities or dealer and ask for the correct method of disposal.

(weee_eu)

The name plate of this product may be found on the bottom of the unit. The serial number of this product may be found on or near the name plate. You should note this serial number in the space provided below and retain this manual as a permanent record of your purchase to aid identification in the event of theft.

Model No.

Serial No.

(bottom)

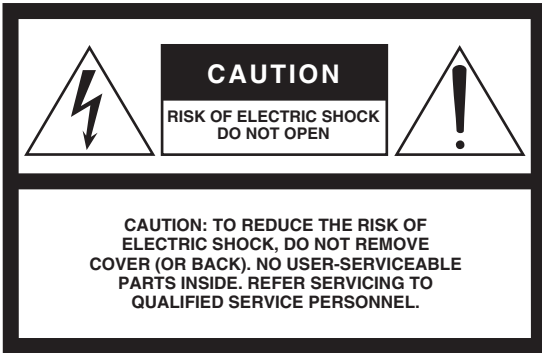

The above warning is located on the bottom of the unit.

Explanation of Graphical Symbols



The lightning flash with arrowhead symbol within an equilateral triangle is intended to alert the user to the presence of uninsulated “dangerous voltage” within the product’s enclosure that may be of sufficient magnitude to constitute a risk of electric shock to persons.



The exclamation point within an equilateral triangle is intended to alert the user to the presence of important operating and maintenance (servicing) instructions in the literature accompanying the product.

IMPORTANT SAFETY INSTRUCTIONS

- 1 Read these instructions.
- 2 Keep these instructions.
- 3 Heed all warnings.
- 4 Follow all instructions.
- 5 Do not use this apparatus near water.
- 6 Clean only with dry cloth.
- 7 Do not block any ventilation openings. Install in accordance with the manufacturer’s instructions.
- 8 Do not install near any heat sources such as radiators, heat registers, stoves, or other apparatus (including amplifiers) that produce heat.
- 9 Do not defeat the safety purpose of the polarized or grounding-type plug. A polarized plug has two blades with one wider than the other. A grounding type plug has two blades and a third grounding prong. The wide blade or the third prong are provided for your safety. If the provided plug does not fit into your outlet, consult an electrician for replacement of the obsolete outlet.
- 10 Protect the power cord from being walked on or pinched particularly at plugs, convenience receptacles, and the point where they exit from the apparatus.
- 11 Only use attachments/accessories specified by the manufacturer.

- 12 Use only with the cart, stand, tripod, bracket, or table specified by the manufacturer, or sold with the apparatus. When a cart is used, use caution when moving the cart/apparatus combination to avoid injury from tip-over.



- 13 Unplug this apparatus during lightning storms or when unused for long periods of time.
- 14 Refer all servicing to qualified service personnel. Servicing is required when the apparatus has been damaged in any way, such as power-supply cord or plug is damaged, liquid has been spilled or objects have fallen into the apparatus, the apparatus has been exposed to rain or moisture, does not operate normally, or has been dropped.

WARNING

TO REDUCE THE RISK OF FIRE OR ELECTRIC SHOCK, DO NOT EXPOSE THIS APPARATUS TO RAIN OR MOISTURE.

(UL60065_03)

Important Notice: Guarantee Information for customers in European Economic Area (EEA) and Switzerland

| | |
|--|-----------------------|
| Important Notice: Guarantee Information for customers in EEA* and Switzerland | English |
| For detailed guarantee information about this Yamaha product, and Pan-EEA* and Switzerland warranty service, please either visit the website address below (Printable file is available at our website) or contact the Yamaha representative office for your country (next page). * EEA: European Economic Area | |
| Wichtiger Hinweis: Garantie-Information für Kunden in der EWR* und der Schweiz | Deutsch |
| Für nähere Garantie-Information über dieses Produkt von Yamaha, sowie über den Pan-EWR*- und Schweizer Garantieservice, besuchen Sie bitte entweder die folgend angegebene Internetadresse (eine druckfähige Version befindet sich auch auf unserer Webseite), oder wenden Sie sich an den für Ihr Land zuständigen Yamaha-Vertrieb (nächste Seite). *EWR: Europäischer Wirtschaftsraum | |
| Remarque importante: informations de garantie pour les clients de l'EEE et la Suisse | Français |
| Pour des informations plus détaillées sur la garantie de ce produit Yamaha et sur le service de garantie applicable dans l'ensemble de l'EEE ainsi qu'en Suisse, consultez notre site Web à l'adresse ci-dessous (le fichier imprimable est disponible sur notre site Web) ou contactez directement Yamaha dans votre pays de résidence (page suivante). * EEE : Espace Economique Européen | |
| Belangrijke mededeling: Garantie-informatie voor klanten in de EER* en Zwitserland | Nederlands |
| Voor gedetailleerde garantie-informatie over dit Yamaha-product en de garantieservice in heel de EER* en Zwitserland, gaat u naar de onderstaande website (u vind een afdrukbaar bestand op onze website) of neemt u contact op met de vertegenwoordiging van Yamaha in uw land (volgende pagina). * EER: Europese Economische Ruimte | |
| Aviso importante: información sobre la garantía para los clientes del EEE* y Suiza | Español |
| Para una información detallada sobre este producto Yamaha y sobre el soporte de garantía en la zona EEE* y Suiza, visite la dirección web que se incluye más abajo (la versión del archivo para imprimir esta disponible en nuestro sitio web) o póngase en contacto con el representante de Yamaha en su país (página siguiente). * EEE: Espacio Económico Europeo | |
| Avviso importante: informazioni sulla garanzia per i clienti residenti nell'EEA* e in Svizzera | Italiano |
| Per informazioni dettagliate sulla garanzia relativa a questo prodotto Yamaha e l'assistenza in garanzia nei paesi EEA* e in Svizzera, potete consultare il sito Web all'indirizzo riportato di seguito (è disponibile il file in formato stampabile) oppure contattate l'ufficio di rappresentanza locale della Yamaha (pagina seguente). * EEA: Area Economica Europea | |
| Aviso importante: informações sobre as garantias para clientes da AEE* e da Suíça | Português |
| Para obter uma informação pormenorizada sobre este produto da Yamaha e sobre o serviço de garantia na AEE* e na Suíça, visite o site a seguir (o arquivo para impressão está disponível no nosso site) ou entre em contato com o escritório de representação da Yamaha no seu país (próxima página). * AEE: Área Económica Europeia | |
| Σημαντική σημείωση: Πληροφορίες εγγύησης για τους πελάτες στον ΕΟΧ* και Ελλάδα | Ελληνικά |
| Για λεπτομερείς πληροφορίες εγγύησης σχετικές με το παρόν προϊόν της Yamaha και την κάλυψη εγγύησης σε όλες τις χώρες του ΕΟΧ και την Ελλάδα, επισκεφτείτε την παρακάτω ιστοσελίδα (Εκτυπώσιμη μορφή είναι διαθέσιμη στην ιστοσελίδα μας) ή απευθυνθείτε στην αντιπροσωπεία της Yamaha στη χώρα σας (επόμενη σελίδα). * ΕΟΧ: Ευρωπαϊκάς Οικονομικός Χώρος | |
| Viktigt: Garantiinformation för kunder i EES-området* och Schweiz | Svenska |
| För detaljerad information om denna Yamahaprodukt samt garantiservice i hela EES-området* och Schweiz kan du antingen besöka nedanstående webbadress (en utskriftsvänlig fil finns på webbplatsen) eller kontakta Yamahas officiella representant i ditt land (nästa sida). * EES: Europeiska Ekonomiska Samarbetsområdet | |
| Viktig merknad: Garantiinformasjon for kunder i EØS* og Sveits | Norsk |
| Detaljert garantiinformasjon om dette Yamaha-produktet og garantiservice for hele EØS-området* og Sveits kan fås enten ved å besøke nettadressen nedenfor (utskriftsversjon finnes på våre nettsider) eller kontakte kontaktene Yamaha-kontoret i landet der du bor (neste side). *EØS: Det europeiske økonomiske samarbeidsområde | |
| Vigtig oplysning: Garantioplysninger til kunder i EØØ* og Schweiz | Dansk |
| De kan finde detaljerede garantioplysninger om dette Yamaha-produkt og den fælles garantiserviceordning for EØØ* (og Schweiz) ved at besøge det websted, der er angivet nedenfor (der findes en fil, som kan udskrives, på vores websted), eller ved at kontakte Yamahas nationale repræsentationskontor i det land, hvor De bor (næste side). * EØØ: Det Europæiske Økonomiske Område | |
| Tärkeä ilmoitus: Takuutiedot Euroopan talousalueen (ETA)* ja Sveitsin asiakkaille | Suomi |
| Tämän Yamaha-tuotteen sekä ETA-alueen ja Sveitsin takuuta koskevat yksityiskohtaiset tiedot saatte alla olevasta nettiosoitteesta. (Tulostettava tiedosto saatavissa sivustollamme.) Voitte myös ottaa yhteyttä paikalliseen Yamaha-edustajaan (seuraavalla sivulla). *ETA: Euroopan talousalue | |
| Ważne: Warunki gwarancyjne obowiązujące w EOG* i Szwajcarii | Polski |
| Aby dowiedzieć się więcej na temat warunków gwarancyjnych tego produktu firmy Yamaha i serwisu gwarancyjnego w całym EOG* i Szwajcarii, należy odwiedzić wskazaną poniżej stronę internetową (Plik gotowy do wydruku znajduje się na naszej stronie internetowej) lub skontaktować się z przedstawicielstwem firmy Yamaha w swoim kraju (następna strona). * EOG — Europejski Obszar Gospodarczy | |
| Důležité oznámení: Záruční informace pro zákazníky v EHS* a ve Švýcarsku | Česky |
| Podrobné záruční informace o tomto produktu Yamaha a záručním servisu v celém EHS* a ve Švýcarsku naleznete na níže uvedené webové adrese (soubor k tisku je dostupný na našich webových stránkách) nebo se můžete obrátit na zastoupení firmy Yamaha ve své zemi (další stránka). * EHS: Evropský hospodářský prostor | |
| Fontos figyelmeztetés: Garancia-információk az EGT* területén és Svájcban élő vásárlók számára | Magyar |
| A jelen Yamaha termékre vonatkozó részletes garancia-információk, valamint az EGT*-re és Svájcra kiterjedő garanciális szolgáltatás tekintetében keresse fel webhelyünket az alábbi címen (a webhelyen nyomtatható fájljt is talál), vagy pedig lépjen kapcsolatba az országában működő Yamaha képviselői irodával (következő oldal). * EGT: Európai Gazdasági Térség | |
| Oluline märkus: Garantiteave Euroopa Majanduspiirkonna (EMP)* ja Šveitsi klientidele | Eesti keel |
| Täpsemalt teada saada selle Yamaha toote garantii ning kogu Euroopa Majanduspiirkonna ja Šveitsi garantiiteeninduse kohta, külastage palun veebisaiti alljärgneval aadressil (meie saidil on saadaval printida fail) või pöörduge Teie regiooni Yamaha esinduse poole (järgmine lehekülg). * EMP: Euroopa Majanduspiirkond | |
| Svarīgs paziņojums: garantijas informācija klientiem EEZ* un Šveicē | Latviešu |
| Lai saņemtu detalizētu garantijas informāciju par šo Yamaha produktu, kā arī garantijas apkalpošanu EEZ* un Šveicē, lūdzam, apmeklējiet zemāk norādīto tīmekļa vietnes adresi (tīmekļa vietnē ir pieejams drukājams fails) vai sazinieties ar jūsu valsti apkalpojošo Yamaha pārstāvniecību (nākamā lappuse). * EEZ: Eiropas Ekonomikas zona | |
| Dėmesio: informacija dėl garantijos pirkėjams EEE* ir Šveicarijoje | Lietuvių kalba |
| Jei reikia išsamios informacijos apie šį „Yamaha“ produktą ir jo techninę priežiūrą visoje EEE* ir Šveicarijoje, apsilankykite mūsų svetainėje toliau nurodytu adresu (svetainėje yra spausdintinas failas) arba kreipkitės į „Yamaha“ atstovybę savo šaliai (kitas puslapis). *EEE – Europos ekonominė erdvė | |
| Dôležité upozornenie: Informácie o záruke pre zákazníkov v EHP* a Švajčiarsku | Slovenčina |
| Podrobnejšie informácie o záruke týkajúce sa tohto produktu od spoločnosti Yamaha a garančnom servise v EHP* a Švajčiarsku nájdete na webovej stránke uvedenej nižšie (na našej webovej stránke je k dispozícii súbor na tlač) alebo sa obráťte na zástupcu spoločnosti Yamaha vo svojej krajine (nasledujúca strana). * EHP: Európsky hospodársky priestor | |
| Pomembno obvestilo: Informacije o garanciji za kupce v EGP* in Švici | Slovenščina |
| Za podrobnejše informacije o tem Yamahinem izdelku ter garancijskem servisu v celotnem EGP in Švici, obiščite spletno mesto, ki je navedeno spodaj (natisljiva datoteka je na voljo na našem spletnem mestu), ali se obrnite na Yamahinega predstavnika v svoji državi (naslednja stran). * EGP: Evropski gospodarski prostor | |
| Важно съобщение: Информация за гаранцията за клиенти в ЕИП* и Швейцария | Български език |
| За подробна информация за гаранцията за този продукт на Yamaha и гаранционното обслужване в паневропейската зона на ЕИП* и Швейцария или посетете посочения по-долу уеб сайт (на нашия уеб сайт има файл за печат), или се свържете с представителния офис на Yamaha във вашата страна (следваща страница). * ЕИП: Европейско икономическо пространство | |
| Notificare importantă: Informații despre garanția pentru clienții din SEE* și Elveția | Limba română |
| Penru informații detaliate privind acest produs Yamaha și serviciul de garanție Pan-SEE* și Elveția, vizitați site-ul la adresa de mai jos (fișierul imprimabil este disponibil pe site-ul nostru) sau contactați biroul reprezentanței Yamaha din țara dumneavoastră (pagina următoare). * SEE: Spațiul Economic European | |

<http://europe.yamaha.com/warranty/>

Yamaha Representative Offices in Europe

AUSTRIA

Yamaha Music Europe GmbH
Branch Austria
Schleiergasse 20, A-1100 Wien Austria
Tel: +43 (0)1 602 03900
Fax: +43 (0)1 602 039051

BELGIUM

Yamaha Music Europe
Branch Benelux
Clarissenhof 5b NL, 4133 AB. Vianen
The Netherlands
Tel: +31 (0)347 358040
Fax: +31 (0)347 358060

BULGARIA

Yamaha Music Europe GmbH
Branch Austria (Central and Eastern Europe)
Schleiergasse 20, A-1100 Wien Austria
Tel: +43 (0)1 602 03900
Fax: +43 (0)1 602 039051

CYPRUS

NAKAS Music Cyprus Ltd.
31C Nikis Ave., 1086 Nicosia
Tel: +357 (0)22 510 477
Fax: +357 (0)22 511 080

CZECH REPUBLIC

Yamaha Music Europe GmbH
Branch Austria (Central and Eastern Europe)
Schleiergasse 20, A-1100 Wien Austria
Tel: +43 (0)1 602 03900
Fax: +43 (0)1 602 039051

DENMARK

YS Copenhagen Liaison Office
(Yamaha Scandinavia AB Filial Denmark)
Generatørvej 6A, 2730 Herlev, Denmark
Tel: +45 44 92 49 00
Fax: +45 44 54 47 09

ESTONIA

Yamaha Music Europe GmbH
Sp. z o.o. Oddział w Polsce
(Branch Poland)
ul. 17 Stycznia 56
PL-02-146 Warszawa Poland
Tel: +48 (0)22 500 29 25
Fax: +48 (0)22 500 29 30

FINLAND

(For Musical Instrument)
F - Musiikki OY
Kaisaniemenkatu 7, PL260
00101 Helsinki, Finland
Tel: +358 (0)9 618511
Fax: +358 (0)9 61851385

(For Pro Audio)

Yamaha Scandinavia AB
J A Wettergrens gata 1
Västra Frölunda, Sweden
(Box 300 53, 400 43 Goteborg
Sweden - Postal Address)
Tel: +46 (0)31 893400
Fax: +46 (0)31 454026

FRANCE

Yamaha Musique France
Zone d'activité de Pariest
7, rue Ambroise Croizat
77183 Croissy-Beaubourg, France
(B.P. 70, 77312 Marne la Vallée Cedex 2
France-Adresse postale)
Tel: +33 (0)1 64 61 4000
Fax: +33 (0)1 64 61 4079

GERMANY

Yamaha Music Europe GmbH
Siemensstr 22-34
D-25462 Rellingen, b. Hamburg, Germany
Tel: +49 (0)4101 3030
Fax: +49 (0)4101 303 77702

GREECE

PH. Nakas S.A.Music House/Service
19 KM Leoforos Lavriou
19002 Peania / Attiki, Greece
Tel: +30 (0)210 6686260
Fax: +30 (0)210 6686269

HUNGARY

Yamaha Music Europe GmbH
Branch Austria (Central and Eastern Europe)
Schleiergasse 20, A-1100 Wien Austria
Tel: +43 (0)1 602 03900
Fax: +43 (0)1 602 039051

ICELAND

(For Musical Instrument)
HLJODFAERAHUSID EHF
Sidumula 20
108 Reykjavik, Iceland
Tel: +354 525 50 50
Fax: +354 568 65 14

(For Pro Audio)

Yamaha Scandinavia AB
J A Wettergrens gata 1
Västra Frölunda, Sweden
(Box 300 53, 400 43 Goteborg
Sweden - Postal Address)
Tel: +46 (0)31 893400
Fax: +46 (0)31 454026

IRELAND (REPUBLIC OF IRELAND)

Yamaha Music UK Ltd.
Sherbourne Drive
Tilbrook, Milton Keynes MK7 8BL
United Kingdom
Tel: +353 (0) 1526 2449
Fax: +44 (0) 1908 369278

ITALY

Yamaha Musica Italia s.p.a.
Viale Italia 88
20020, Lainate (Milano), Italy
Tel: +39 (0)02 93577 1
Fax: +39 (0)02 937 0956

LATVIA

Yamaha Music Europe GmbH
Sp. z o.o. Oddział w Polsce
(Branch Poland)
ul. 17 Stycznia 56
PL-02-146 Warszawa Poland
Tel: +48 (0)22 500 29 25
Fax: +48 (0)22 500 29 30

LIECHTENSTEIN

Yamaha Music Europe GmbH, Rellingen,
Branch Switzerland in Zurich
Seefeldstrasse 94, CH-8008
Zürich, Switzerland
Tel: +41 (0)44 3878080
Fax: +41 (0)44 3833918

LITHUANIA

Yamaha Music Europe GmbH
Sp. z o.o. Oddział w Polsce
(Branch Poland)
ul. 17 Stycznia 56
PL-02-146 Warszawa Poland
Tel: +48 (0)22 500 29 25
Fax: +48 (0)22 500 29 30

LUXEMBOURG

Yamaha Music Europe
Branch Benelux
Clarissenhof 5b NL, 4133 AB. Vianen
The Netherlands
Tel: +31 (0)347 358040
Fax: +31 (0)347 358060

MALTA

Olimpus Music Ltd.
The Emporium, Level 3, St. Louis Street
Msida MSD06
Tel: +356 (0)2133 2093
Fax: +356 (0)2133 2144

NETHERLANDS

Yamaha Music Europe
Branch Benelux
Clarissenhof 5b NL, 4133 AB. Vianen
The Netherlands
Tel: +31 (0)347 358040
Fax: +31 (0)347 358060

NORWAY

YS Oslo Liaison Office
(Yamaha Scandinavia AB Filial Norway)
Grini Naeringspark 1
1361 Osteras, Norway
Tel: +47 67 16 77 70
Fax: +47 67 16 77 79

POLAND

YAMAHA Music Europe GmbH
Sp. z o.o. Oddział w Polsce
ul. 17 Stycznia 56
02-146 WARSZAWA/POLSKA
Tel: +48 (0)22 500 29 25
Fax: +48 (0)22 500 29 30

PORTUGAL

Yamaha Música Ibérica, S.A.U.
Sucursal Portuguesa
Rua Alfredo da Silva
2610-016 Amadora, Portugal
Tel: +351 214 704 330
Fax: +351 214 718 220

ROMANIA

Yamaha Music Europe GmbH
Branch Austria (Central and Eastern
Europe)
Schleiergasse 20, A-1100 Wien Austria
Tel: +43 (0)1 602 03900
Fax: +43 (0)1 602 039051

SLOVAKIA

Yamaha Music Europe GmbH
Branch Austria (Central and Eastern
Europe)
Schleiergasse 20, A-1100 Wien Austria
Tel: +43 (0)1 602 03900
Fax: +43 (0)1 602 039051

SLOVENIA

Yamaha Music Europe GmbH
Branch Austria (Central and Eastern
Europe)
Schleiergasse 20, A-1100 Wien Austria
Tel: +43 (0)1 602 03900
Fax: +43 (0)1 602 039051

SPAIN

Yamaha Música Ibérica, S.A.U.
Ctra. de la Coruna km.17, 200
28230 Las Rozas de Madrid, Spain
Tel: +34 902 39 8888
Fax: +34 91 638 4660

SWEDEN

Yamaha Scandinavia AB
J A Wettergrens gata 1
Västra Frölunda, Sweden
(Box 300 53, 400 43 Goteborg
Sweden - Postal Address)
Tel: +46 (0)31 893400
Fax: +46 (0)31 454026

SWITZERLAND

Yamaha Music Europe GmbH, Rellingen,
Branch Switzerland in Zurich
Seefeldstrasse 94, CH-8008
Zürich, Switzerland
Tel: +41 (0)44 3878080
Fax: +41 (0)44 3833918

UNITED KINGDOM

Yamaha Music UK Ltd.
Sherbourne Drive
Tilbrook, Milton Keynes MK7 8BL
United Kingdom
Tel: +44 (0) 870 4445575
Fax: +44 (0) 1908 369278



Yamaha Home Keyboards Home Page

<http://music.yamaha.com/homekeyboard/>

Yamaha Manual Library

<http://www.yamaha.co.jp/manual/>

C.S.G., Digital Musical Instruments Division
© 2011-2013 Yamaha Corporation

WV81530

304MW***.*C1