



YPR-50

Owner's Manual



SPECIAL MESSAGE SECTION

This product utilizes batteries or an external power supply (adapter). DO NOT connect this product to any power supply or adapter other than one described in the manual, on the name plate, or specifically recommended by Yamaha.

WARNING: Do not place this product in a position where anyone could walk on, trip over, or roll anything over power or connecting cords of any kind. The use of an extension cord is not recommended! IF you must use an extension cord, the minimum wire size for a 25' cord (or less) is 18 AWG. NOTE: The smaller the AWG number, the larger the current handling capacity. For longer extension cords, consult a local electrician.

This product should be used only with the components supplied or; a cart, rack, or stand that is recommended by Yamaha. If a cart, etc., is used, please observe all safety markings and instructions that accompany the accessory product.

SPECIFICATIONS SUBJECT TO CHANGE:

The information contained in this manual is believed to be correct at the time of printing. However, Yamaha reserves the right to change or modify any of the specifications without notice or obligation to update existing units.

This product, either alone or in combination with an amplifier and headphones or speaker/s, may be capable of producing sound levels that could cause permanent hearing loss. DO NOT operate for long periods of time at a high volume level or at a level that is uncomfortable. If you experience any hearing loss or ringing in the ears, you should consult an audiologist. IMPORTANT: The louder the sound, the shorter the time period before damage occurs.

NOTICE:

Service charges incurred due to a lack of knowledge relating to how a function or effect works (when the unit is operating as designed) are not covered by the manufacturer's warranty, and are therefore the owners responsibility. Please study this manual carefully and consult your dealer before requesting service.

ENVIRONMENTAL ISSUES:

Yamaha strives to produce products that are both user safe and environmentally friendly. We sincerely believe that our products and the production methods used to produce them, meet these goals. In keeping with both the letter and the spirit of the law, we want you to be aware of the following:

Battery Notice:

This product MAY contain a small non-rechargeable battery which (if applicable) is soldered in place. The average life span of this type of battery is approximately five years. When replacement becomes necessary, contact a qualified service representative to perform the replacement.

This product may also use "household" type batteries. Some of these may be rechargeable. Make sure that the battery being charged is a rechargeable type and that the charger is intended for the battery being charged.

When installing batteries, do not mix batteries with new, or with batteries of a different type. Batteries MUST be installed correctly. Mismatches or incorrect installation may result in overheating and battery case rupture.

Warning:

Do not attempt to disassemble, or incinerate any battery. Keep all batteries away from children. Dispose of used batteries promptly and as regulated by the laws in your area. Note: Check with any retailer of household type batteries in your area for battery disposal information.

Disposal Notice:

Should this product become damaged beyond repair, or for some reason its useful life is considered to be at an end, please observe all local, state, and federal regulations that relate to the disposal of products that contain lead, batteries, plastics, etc. If your dealer is unable to assist you, please contact Yamaha directly.

NAME PLATE LOCATION:

The name plate is located on the bottom of the product. The model number, serial number, power requirements, etc., are located on this plate. You should record the model number, serial number, and the date of purchase in the spaces provided below and retain this manual as a permanent record of your purchase.

Model

Serial No.

Purchase Date

PLEASE KEEP THIS MANUAL

92-BP (bottom)

FCC INFORMATION (U.S.A.)

1. IMPORTANT NOTICE: DO NOT MODIFY THIS UNIT!

This product, when installed as indicated in the instructions contained in this manual, meets FCC requirements. Modifications not expressly approved by Yamaha may void your authority, granted by the FCC, to use the product.

2. IMPORTANT: When connecting this product to accessories and/or another product use only high quality shielded cables. Cable/s supplied with this product MUST be used. Follow all installation instructions. Failure to follow instructions could void your FCC authorization to use this product in the USA.

3. NOTE: This product has been tested and found to comply with the requirements listed in FCC Regulations, Part 15 for Class "B" digital devices. Compliance with these requirements provides a reasonable level of assurance that your use of this product in a residential environment will not result in harmful interference with other electronic devices. This equipment generates/uses radio frequencies and, if not installed and used according to the instructions found in the users manual, may cause interference harmful to the operation of other electronic devices. Compliance with FCC regulations does not guarantee that interference will not occur in all installations. If this product is found to be the source of interference, which can be determined by turning the unit "OFF" and "ON", please try to eliminate the problem by using one of the following measures:

Relocate either this product or the device that is being affected by the interference.

Utilize power outlets that are on different branch (circuit breaker or fuse) circuits or install AC line filter/s.

In the case of radio or TV interference, relocate/reorient the antenna. If the antenna lead-in is 300 ohm ribbon lead, change the lead-in to co-axial type cable.

If these corrective measures do not produce satisfactory results, please contact the local retailer authorized to distribute this type of product. If you can not locate the appropriate retailer, please contact Yamaha Corporation of America, Electronic Service Division, 6600 Orangethorpe Ave, Buena Park, CA90620

The above statements apply ONLY to those products distributed by Yamaha Corporation of America or its subsidiaries.

(class B)

* This applies only to products distributed by YAMAHA CORPORATION OF AMERICA.

PRECAUTIONS

PLEASE READ CAREFULLY BEFORE PROCEEDING

* Please keep these precautions in a safe place for future reference.



WARNING

Always follow the basic precautions listed below to avoid the possibility of serious injury or even death from electrical shock, short-circuiting, damages, fire or other hazards. These precautions include, but are not limited to, the following:

- Do not open the instrument or attempt to disassemble the internal parts or modify them in any way. The instrument contains no user-serviceable parts. If it should appear to be malfunctioning, discontinue use immediately and have it inspected by qualified Yamaha service personnel.
- Do not expose the instrument to rain, use it near water or in damp or wet conditions, or place containers on it containing liquids which might spill into any openings.
- If the AC adaptor cord or plug becomes frayed or damaged, or if there is a sudden loss of sound during use of the instrument, or if any unusual smells or smoke should appear to be caused by it, immediately turn off the power switch, disconnect the adaptor plug from the outlet, and have the instrument inspected by qualified Yamaha service personnel.
- Use the specified adaptor (PA-3B or an equivalent recommended by Yamaha) only. Using the wrong adaptor can result in damage to the instrument or overheating.
- Before cleaning the instrument, always remove the electric plug from the outlet. Never insert or remove an electric plug with wet hands.
- Check the electric plug periodically and remove any dirt or dust which may have accumulated on it.



CAUTION

Always follow the basic precautions listed below to avoid the possibility of physical injury to you or others, or damage to the instrument or other property. These precautions include, but are not limited to, the following:

- Do not place the AC adaptor cord near heat sources such as heaters or radiators, and do not excessively bend or otherwise damage the cord, place heavy objects on it, or place it in a position where anyone could walk on, trip over, or roll anything over it.
- When removing the electric plug from the instrument or an outlet, always hold the plug itself and not the cord.
- Do not connect the instrument to an electrical outlet using a multiple-connector. Doing so can result in lower sound quality, or possibly cause overheating in the outlet.
- Unplug the AC power adaptor when not using the instrument, or during electrical storms.
- Always make sure all batteries are inserted in conformity with the +/- polarity markings. Failure to do so might result in overheating, fire, or battery fluid leakage.
- Always replace all batteries at the same time. Do not use new batteries together with old ones. Also, do not mix battery types, such as alkaline batteries with manganese batteries, or batteries from different makers, or different types of batteries from the same maker, since this can cause overheating, fire, or battery fluid leakage.
- Do not dispose of batteries in fire.
- Do not attempt to recharge batteries that are not intended to be charged.
- If the instrument is not to be in use for a long time, remove the batteries from it, in order to prevent possible fluid leakage from the battery.
- Keep batteries away from children.
- Before connecting the instrument to other electronic components, turn off the power for all components. Before turning the power on or off for all components, set all volume levels to minimum. Also, be sure to set the volumes of all components at their minimum levels and gradually raise the volume controls while playing the instrument to set the desired listening level.
- Do not expose the instrument to excessive dust or vibrations, or extreme cold or heat (such as in direct sunlight, near a heater, or in a car during the day) to prevent the possibility of panel disfiguration or damage to the internal components.
- Do not use the instrument near other electrical products such as televisions, radios, or speakers, since this might cause interference which can affect proper operation of the other products.
- Do not place the instrument in an unstable position where it might accidentally fall over.
- Before moving the instrument, remove all connected adaptor and other cables.
- When cleaning the instrument, use a soft, dry cloth. Do not use paint thinners, solvents, cleaning fluids, or chemical-impregnated wiping cloths. Also, do not place vinyl, plastic or rubber objects on the instrument, since this might discolor the panel or keyboard.
- Do not rest your weight on, or place heavy objects on the instrument, and do not use excessive force on the buttons, switches or connectors.
- Use only the stand/rack specified for the instrument. When attaching the stand or rack, use the provided screws only. Failure to do so could cause damage to the internal components or result in the instrument falling over.
- Do not operate the instrument for a long period of time at a high or uncomfortable volume level, since this can cause permanent hearing loss. If you experience any hearing loss or ringing in the ears, consult a physician.

Yamaha cannot be held responsible for damage caused by improper use or modifications to the instrument, or data that is lost or destroyed.

Always turn the power off when the instrument is not in use.

Make sure to discard used batteries according to local regulations.

The illustrations as shown in this owner's manual are for instructional purposes only, and may be different from the ones your instrument.

Congratulations on your purchase of the Yamaha YPR-50 Portable Piano!

You now own a portable piano that combines advanced functions, great sound and exceptional ease-of-use in a highly compact package. Its outstanding features also make it a remarkably expressive and versatile instrument.

Read this Owner's Manual carefully while playing your new YPR-50 in order to take full advantage of its various features.

Main Features

The YPR-50 is a sophisticated yet easy-to-use keyboard with the following features and functions:

- Exceptionally realistic and dynamic sounds with five voices – Grand Piano, Electric Piano, Harpsichord, Organ, and Strings – each created from digital recordings of actual instruments.
- Stereo Sampled Piano – The Grand Piano voice is especially realistic, thanks to sophisticated stereo sampling.
- Full-size 76-key keyboard, with adjustable Touch Sensitivity.
- Full 32-note polyphony lets you play complex sustained chords and passages, without worrying about notes being cut off.
- Pianist feature automatically produces stylistically appropriate piano accompaniment, instantly and effortlessly making your performances sound more professional. A total of twenty Pianist styles are available. Also included is a Song Book that gives you easy-to-read sheet music for exploring and enjoying these styles to the fullest.
- Convenient control over songs and Pianist styles – including Tempo and CD-player-like "transport" buttons.
- Metronome function with modifiable time signature, for practice purposes.
- Twenty songs, for listening enjoyment – or for learning and playing along with, using the powerful Melody Guide functions.
- MIDI terminals for interfacing with other MIDI devices, and a Damper switch jack.
- Built-in, high-quality stereo amplifier/speaker system.



Contents

Main Features	4	Touch Response	20
		Setting the Touch Sensitivity	20
Panel Controls and Terminals	6	Using the Metronome	21
		Setting the Metronome Time Signature ..	22
Setting Up	8	The Pianist – Automatic	
Power Requirements	8	Accompaniment Styles	23
Accessory Jacks	8	Selecting a Pianist Style and Playing the	
Music Stand	9	Accompaniment	23
Quick Guide	10	Using the Pianist Accompaniment – Multi	
Playing Your New YPR-50!	10	Fingering	24
Using the metronome	11	Single Finger Chords	24
Other important functions	11	Fingered Chords	25
Playing the Songs	12	Song Controls	26
Playing all 20 songs in order	12	Song “transport” buttons	26
Controlling the song	12	START/STOP, SELECT	26
Playing a single selected song	13	PAUSE	26
Practicing Along With the Song	14	REW (Rewind)	26
Practicing different song parts	14	FF (Fast Forward)	27
Beat lamps	14	Part on/off control	27
Changing the tempo	15	MIDI	28
Using the metronome	15	About MIDI	28
Professional-sounding “Pianist”		How Can MIDI be Used?	28
Stylings	16	PIANIST STYLE Default Tempos	29
Changing the tempo	16	Troubleshooting	29
Beat lamps	17	Keyboard Stand Assembly Instructions ..	30
Using the metronome	17	Specifications	32
Transpose and Tuning	18	MIDI Implementation Chart	33
Transpose	18		
Tuning	18		

Panel Controls and Terminals

Front Panel

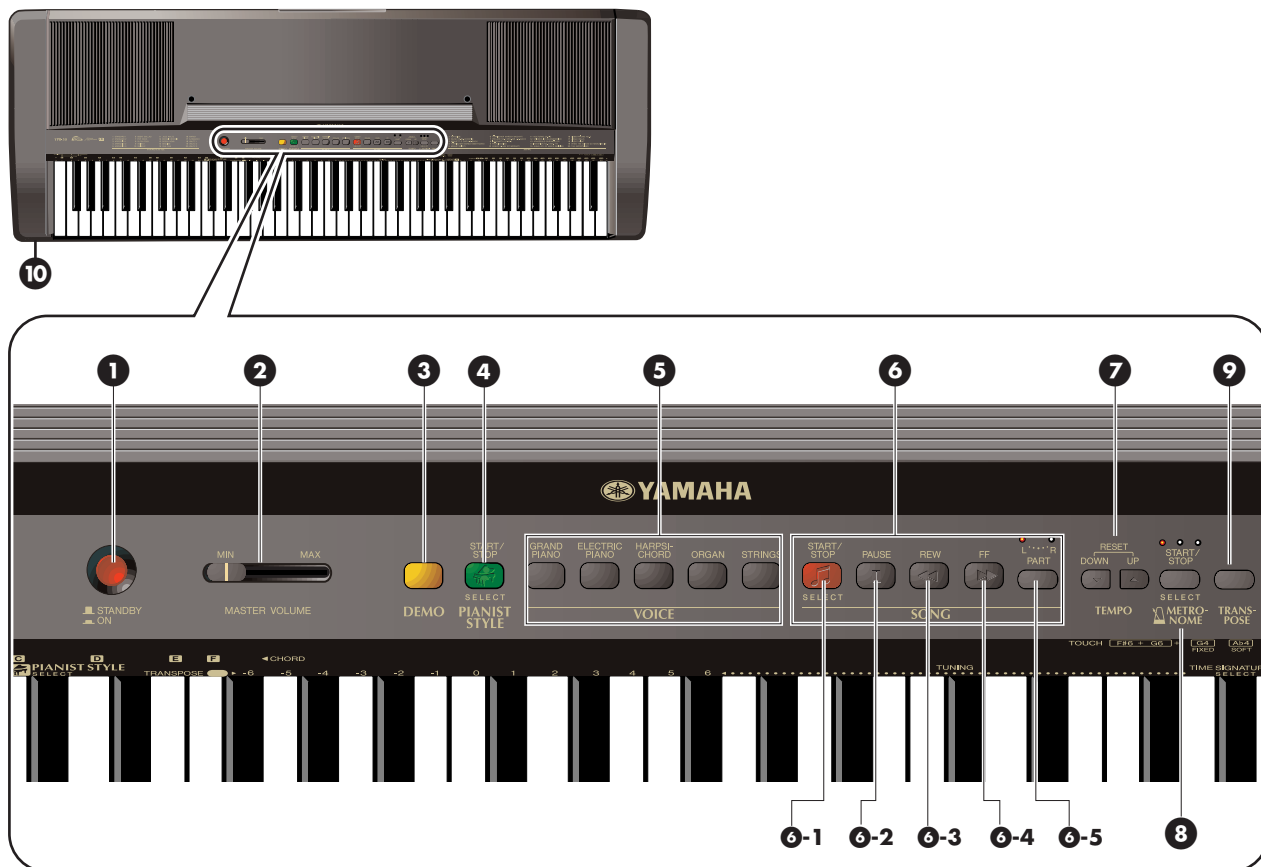

① Power switch (STANDBY/ON)

② MASTER VOLUME control

This determines the overall volume of the YPR-50. (Page 10.)

③ DEMO button

This is for starting and stopping song playback. (Page 12.)

④ PIANIST STYLE button (START/STOP, SELECT)

This turns the Pianist feature on and off. It is also used with certain keys on the keyboard (E0 - B1) to select the various Pianist styles, as well as play back the ending patterns. (Pages 16, 23.)

⑤ VOICE buttons (GRAND PIANO, E. PIANO, HARPSICHORD, ORGAN, STRINGS)

These are used to select the various voices of the YPR-50. (Page 11.)

⑥ SONG buttons

These are used to control playback of the songs. (Pages 12, 13, 26.)

⑥-1 START/STOP, SELECT button

This is used to start and stop song playback. It is also used with certain keys on the keyboard (C5 - G6) to select the songs. (Pages 13, 26.)

⑥-2 PAUSE button

This is used during song playback to alternately pause and resume song playback. (Pages 12, 26.)

⑥-3 REW button

This is used to move measure-by-measure in reverse through a selected song. (Pages 13, 26.)

⑥-4 FF button

This is used to move measure-by-measure forward through a selected song. (Pages 13, 27.)

⑥-5 PART button

This is used to select one or both of the left- and right-hand parts of the songs. (Pages 14, 27.)



7 TEMPO buttons (DOWN, UP)

These are used to adjust the tempo of the song or Pianist accompaniment. They can also be used with certain keys on the keyboard (E \flat 5 - G6) to select preset tempo values. (Pages 15, 21.)

8 METRONOME START/STOP, SELECT button

This is used to start and stop the metronome. (Pages 15, 21.) This is also used to select the time signature. (Page 22.)

9 TRANSPOSE button

This is used with certain keys on the keyboard (F \sharp 2 - F \sharp 3) to set the key transposition for the instrument. (Page 18.)

10 PHONES/OUTPUT jack

This is for connection to a set of stereo headphones or to an external amplifier/speaker system. (Page 8.)

Rear Panel

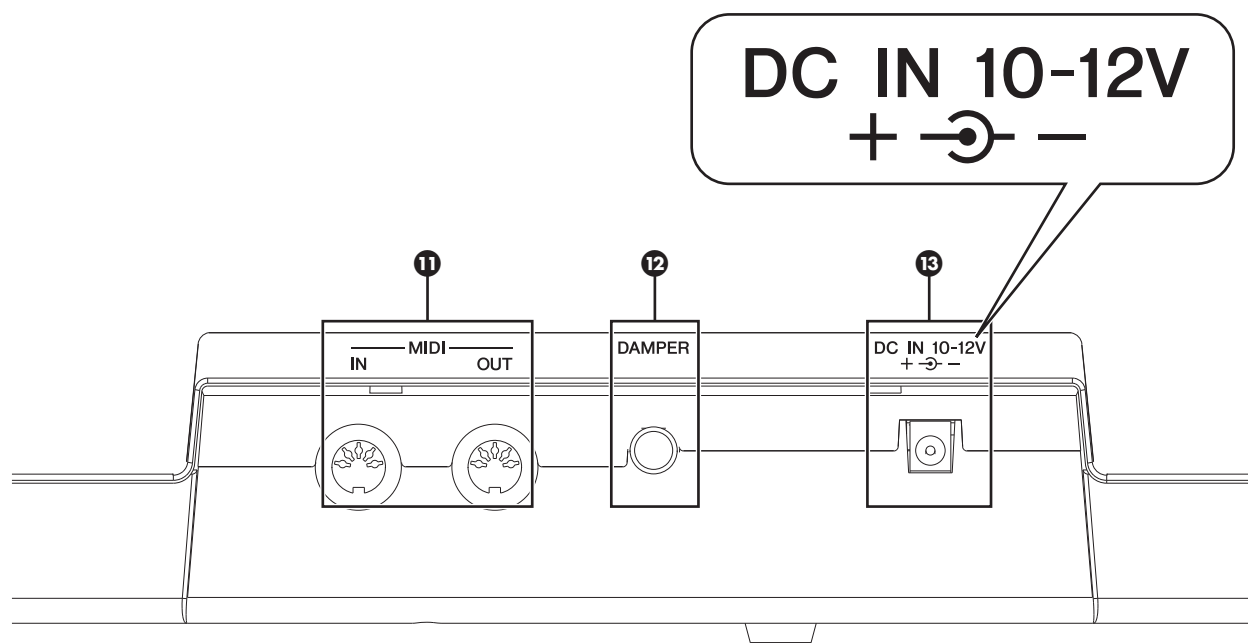
**11 MIDI IN, OUT terminals**

These are for connection to other MIDI instruments and devices. (Pages 9, 28.)

12 DAMPER jack

This is for connection to the included Footswitch. (Page 9.)

13 DC IN 10-12V jack

This is for connection to a PA-3B AC power adaptor. (Page 8.)

Setting Up

This section contains useful information about setting up your YPR-50 for playing. Make sure to read this section carefully before using the instrument.

Power Requirements

Although the YPR-50 will run either from an optional AC adaptor or batteries, Yamaha recommends use of an AC adaptor whenever possible. An AC adaptor is more environmentally friendly than batteries and does not deplete resources.

Using an AC Power Adaptor

To connect your YPR-50 to a wall socket, you will need the optionally available Yamaha PA-3B Power Adaptor. Use of other AC adaptors could result in damage to the instrument, so be sure to ask for the right kind. Connect one end of the adaptor to the DC IN 10-12V jack on the rear panel of your YPR-50, and the other end to a suitable electrical outlet.

WARNING
Use ONLY a Yamaha PA-3B AC Power Adaptor (or other adaptor specifically recommended by Yamaha) to power your instrument from the AC mains. The use of other adaptors may result in irreparable damage to both the adaptor and the YPR-50.

CAUTION
Unplug the AC Power Adaptor when not using the YPR-50, or during electrical storms.

Using Batteries

■ Inserting Batteries

Turn the instrument upside-down and remove the battery compartment lid. Insert six 1.5-volt size "D" (SUM-1, R-20 or equivalent) batteries as shown in the illustration, making sure that the positive and negative terminals are properly aligned, and replace the lid.

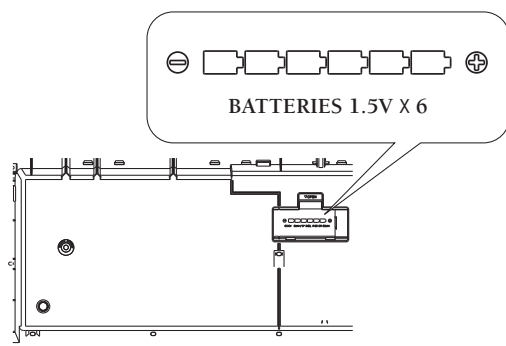

■ When the Batteries Run Down

When the batteries run low and the battery voltage drops below a certain level, the YPR-50 may not sound or function properly. As soon as this happens, replace them with a complete set of six new batteries.

CAUTION
Never mix old and new batteries or different types of batteries (e.g., alkaline and manganese).

CAUTION
To prevent possible damage from battery leakage, remove the batteries from the instrument if it is not to be used for a long time.

Accessory Jacks

Using Headphones

For private practicing and playing without disturbing others, connect a set of stereo headphones to the rear panel PHONES/OUTPUT jack. Sound from the built-in speaker system is automatically cut off when you insert a headphone plug into this jack.

Connecting a Keyboard Amplifier or Stereo System

Though the YPR-50 is equipped with a built-in speaker system, you can also play it through an external amplifier/speaker system. First, make sure the YPR-50 and any external devices are turned off, then connect one end of a stereo audio cable to the LINE IN or AUX IN jack(s) of the other device and the other end to the rear panel PHONES/OUTPUT jack on the YPR-50.

CAUTION
To prevent damage to the speakers, set the volume of the external devices at the minimum setting before connecting them. Failure to observe these cautions may result in electric shock or equipment damage. Also, be sure to set the volumes of all devices at their minimum levels and gradually raise the volume controls while playing the instrument to set the desired listening level.

Using a Sustain Footswitch

This feature lets you use the included footswitch (Yamaha FC-5) or an optional footswitch (Yamaha FC-4) to sustain the sound of the keyboard voice. This is used in the same way as a damper pedal on an acoustic piano – press and hold down the footswitch as you play the keyboard to sustain the sound.

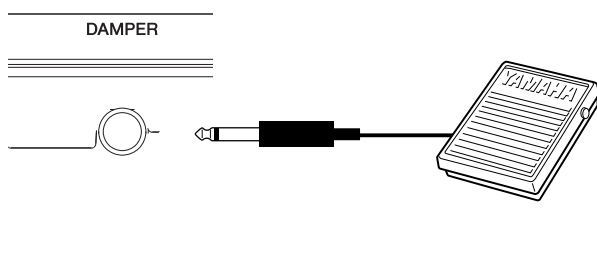

NOTE Make sure that the footswitch plug is properly connected to the DAMPER jack before turning on the power.

NOTE Do not press the footswitch while turning the power on. Doing this changes the recognized polarity of the footswitch, resulting in reversed footswitch operation.

Using the MIDI Terminals

The YPR-50 also features MIDI terminals, allowing you to interface the YPR-50 with other MIDI instruments and devices. (For more information, see page 28.)

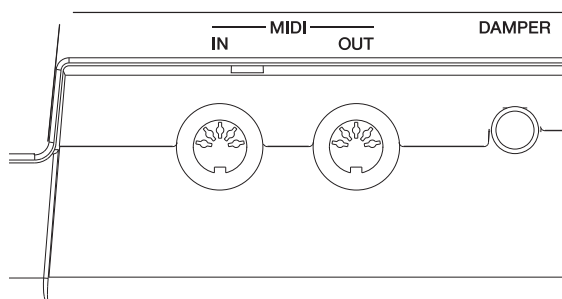

Music Stand

Insert the bottom pins of the included music stand into the holes located at the center of the YPR-50 control panel.

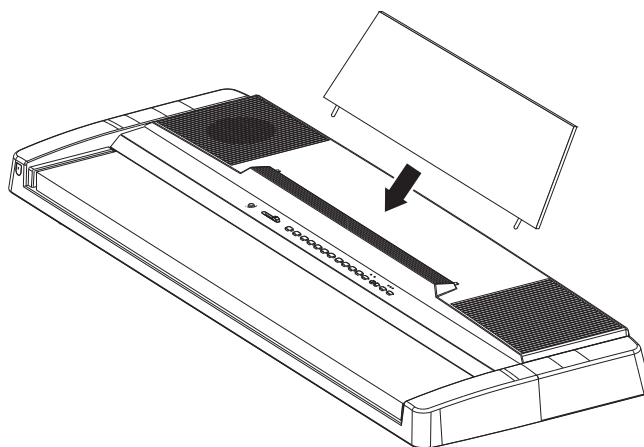

Quick Guide

Playing Your New YPR-50!

The YPR-50 features a set of exceptionally realistic stereo sampled piano sounds and other instrument sounds, including organ and strings — all created with state-of-the-art digital recording. It also features an extraordinarily expressive 76-key keyboard, with dynamic touch response. Try selecting some of these voices and start playing the YPR-50!

1. Turn on the power

Press the STANDBY/ON switch to turn on the power.

To turn off the power, press the switch again.

NOTE Even when the switch is in the "STANDBY" position, electricity is still flowing to the instrument at the minimum level. When you are not using the YPR-50 for a long time, make sure you unplug the AC power adaptor from the wall AC outlet, and/or remove the batteries from the instrument.

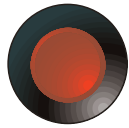

■ STANDBY
■ ON

2. Adjust the volume

Play the keyboard and move the MASTER VOLUME control or slider, until the sound reaches a comfortable level.

Slide the control to the left to turn the volume down. Slide the control to the right to turn the volume up.

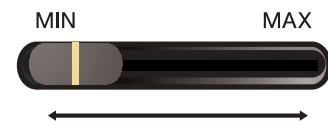

MASTER VOLUME

3. Play the YPR-50's keyboard

The YPR-50 features an extended 76-key keyboard (from E0 - G6), and has full touch response for dynamic, expressive control.

NOTE The touch response sensitivity can be set. (See page 20.)

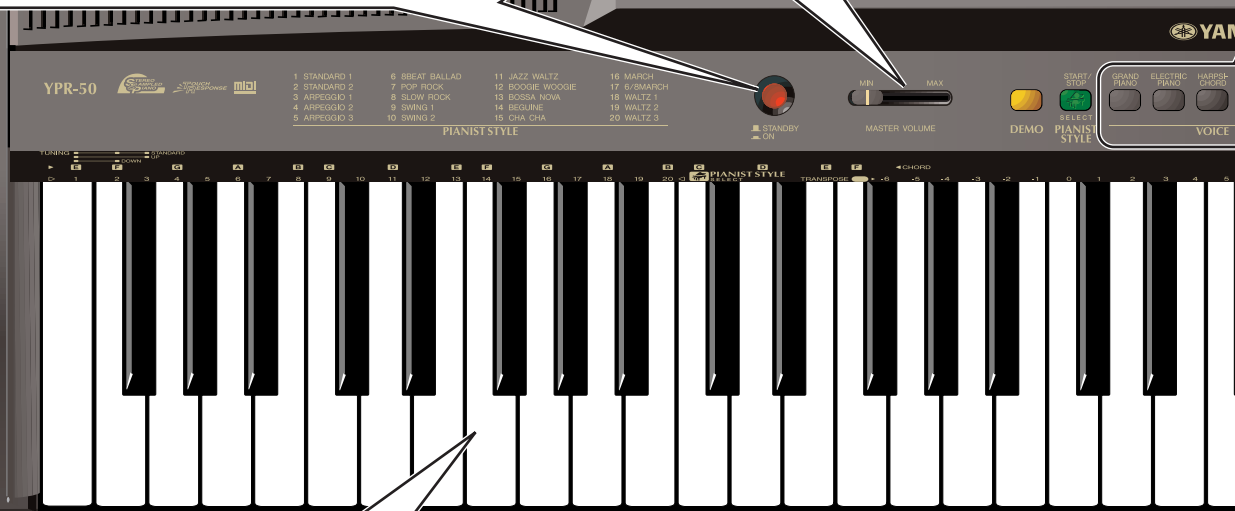

Select one of the voices.

Press the desired VOICE button.

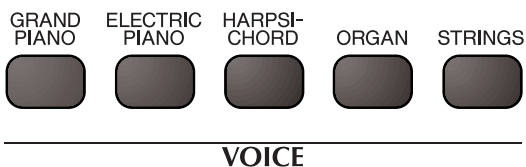

Using the metronome

The metronome is an exceptionally convenient tool for practicing.

To start the metronome at the currently selected tempo, press the METRONOME button. To stop the metronome, press the METRONOME button again.

NOTE The Beat lamp flashes while the metronome is running.

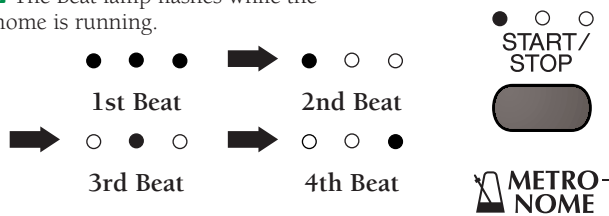

NOTE You can freely change the tempo or time signature. (See page 22.)

Other important functions

The YPR-50 also features the following other convenient functions:

Transpose (Page 18)

This lets you change the overall key transposition of the instrument in semitone steps.

Tuning (Page 18)

This lets you make fine adjustments to the overall tuning of the instrument.

Sustain Pedal (Page 9)

This pedal can be used to sustain the sound, in the same way as a damper pedal on an actual acoustic piano.



Playing a single selected song

Hold down the SONG (SELECT) button and press the appropriate key (C5 - G6, as indicated on the panel) to select the desired song. The selected song starts playing back as soon as you release the SONG button.

To stop the song, press the SONG button again.

NOTE If you press the SONG button without selecting a specific song, the currently selected song will play.

1 FÜR ELISE	6 TÜRKISCHER MARSCH (MOZART)	11 NOCTURNE, OP. 9-2	16 LIEBESTRÄUME NO. 3
2 WALSE, OP. 84-1 (CHOPIN)	7 PRELUDE NO. 1, BWV, 846 (J.S. BACH)	12 SPINNERLIED (ELLEMENREICH)	17 JINGLE BELLS
3 MENUETT G. DUR (J.S. BACH)	8 IMPROMPTU, OP. 90-2	13 ARABESQUE (BURGMÜLLER)	18 SILENT NIGHT
4 TÜRKISCHER MARSCH (BEETHOVEN)	9 FRÜHLINGSLIED	14 INVENTION NO. 1, BWV, 772	19 WHEN THE SAINTS GO MARCHING IN
5 MENUETT (BIZET)	10 SONATE K. 545 1ST (MOZART)	15 JESUS, JOY OF MAN'S DESIRING	20 THE ENTERTAINER

ANS-OSE

SOFT MEDIUM BRIGHT

START/STOP SELECT

SONG

TEMPO 40 60 70 80 90 100 110 120 130 140 150 160 170 180 200

C5 G6



REW (Rewind)

Hold this button down to move measure-by-measure in reverse through the song. The song automatically starts playing back from the selected point as soon as the REW button is released.

FF (Fast Forward)

Hold this button down to fast forward through the song. The song automatically starts playing back from the selected point as soon as the FF button is released.

NOTE The REW and FF buttons can also be used when playback is paused; to start playback again from the selected position, press the SELECT (START/STOP) button. (In this case, the PAUSE button cannot be used to start playback.)

NOTE The song cannot be heard when holding down the REW button.



Practicing Along With the So

The YPR-50 provides a variety of useful tools to help you practice. You can change the tempo (speed) of the song, and select Parts L (LEFT) and R (RIGHT) for playback. There's even a special Song Book with easy-to-learn pieces that gets you started.

Practicing different song parts

The YPR-50 lets you independently play back the left-hand and right-hand parts of the songs. For example, you may want have only the left-hand accompaniment part sound while you practice the melody part with your right hand.

Pressing the PART button switches among the following three Part On/Off settings:

Both parts are on (default)

Only the left part is on – letting you play the other part with your right hand

Only the right part is on – letting you play the other part with your left hand

The Part lamps indicate which part is selected and active.

Both parts can be heard.



Only the left part can be heard.



Only the right part can be heard.



NOTE The Part setting can be changed even during song playback.

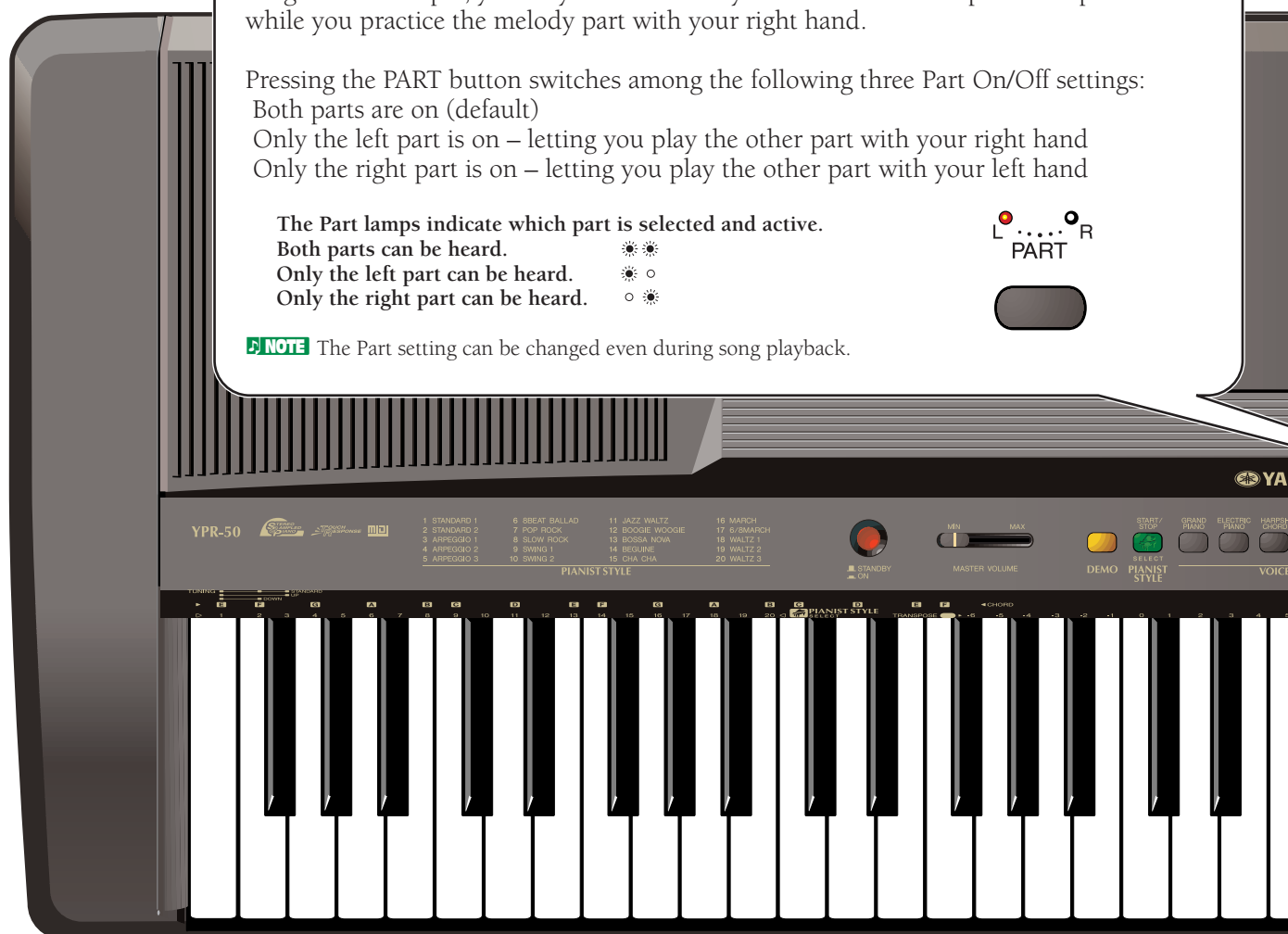

Beat lamps

The Beat lamps flash in time at the currently set tempo and time signature.

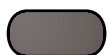

1st Beat

2nd Beat

3rd Beat

4th Beat



Changing the tempo

The tempo of the song can be set to any desired speed. This is particularly convenient for practice purposes, letting you set the tempo of the song to a comfortable speed for playing along with. You can also slow the tempo down to whatever speed you need when trying to learn difficult passages by ear.

Adjusting the tempo

To raise or lower the tempo, press the TEMPO UP or DOWN button. (The range is 40-240 beats per minute.)

The tempo speeds up by a small amount with each press of the TEMPO UP button.

The tempo slows down by a small amount with each press of the TEMPO DOWN button.

Each song has been given a "preset" or ideal tempo for playback. To instantly reset the preset tempo for the song, simultaneously press both the TEMPO UP and TEMPO DOWN buttons.

Setting the tempo value directly

You can also select preset tempo values with this alternate method, convenient for when you want to quickly "jump" to a certain tempo range. For the preset tempo values, the range is 40-200 quarter-note beats per minute.

To set the tempo, simultaneously hold down both the TEMPO UP and TEMPO DOWN buttons and press the appropriate key (E \flat 5 - G6) corresponding to the desired tempo.

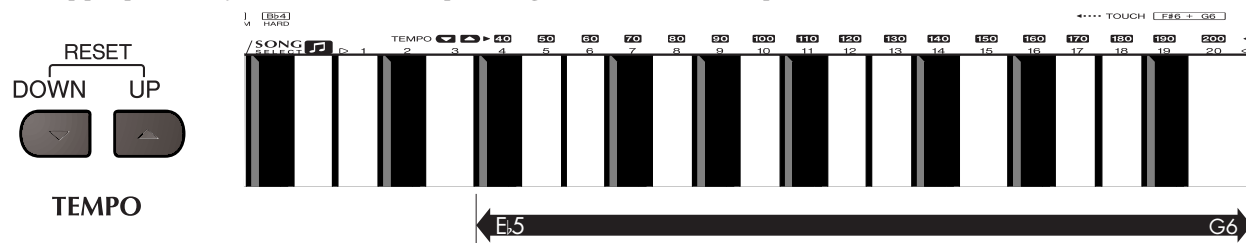

Using the metronome

The metronome is convenient practice tool, since it helps you stay in time when playing with a difficult song or playing with only one of the song parts. The metronome beats in perfect time with the music, helping you to play more accurately.

To use the metronome, press the METRONOME START/STOP button while the song is playing back. The metronome automatically sounds at the same tempo and time signature of the selected song. To stop the metronome, press the METRONOME button again.



NOTE If you wish, you can change the time signature and tempo. (See above and page 22.)

Professional-sounding "Pianist"

The powerful yet easy-to-use Pianist feature automatically provides professional-quality piano accompaniment for your own performances – all you have to do is play the desired chords with your left hand and use your right hand to play the melody. Twenty different Pianist styles are available. The included Song Book also gives you easy-to-read sheet music to help you get the most out of these styles. Try it out now and see how easy it is to sound like a pro!

1. Select the desired Pianist style

To select the desired Pianist style pattern, simultaneously hold down the PIANIST STYLE button and press the appropriate key (E0 - B1). The style is automatically set to standby.

NOTE Pressing only the PIANIST STYLE button (without selecting a style) sets the previously selected style to standby.

NOTE Pressing the PIANIST STYLE button while standby is active turns off the Pianist feature.

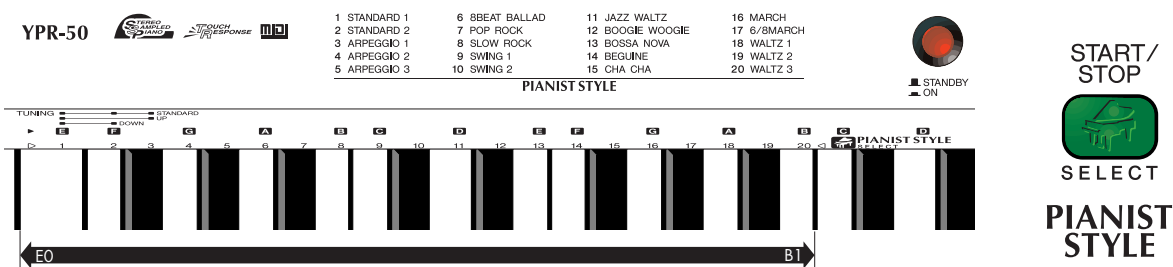

3. Stop the Pianist style

To stop the Pianist style, press the PIANIST STYLE button again. An ending pattern automatically plays back before the style is stopped.

Changing the tempo

When you select the Pianist style, the best-suited tempo and time signature is automatically called up as well. Naturally, you can change the tempo of the song – for example, you can make it slower to help when you practice.

Adjusting the tempo

To raise or lower the tempo, press the TEMPO UP or DOWN button.

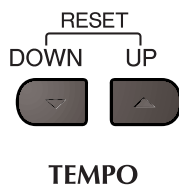

The tempo speeds up by a small amount with each press of the TEMPO UP button. The tempo slows down by a small amount with each press of the TEMPO DOWN button. Each song has been given a "preset" or ideal tempo for playback. To instantly reset the preset tempo for the song, simultaneously press both the TEMPO UP and TEMPO DOWN buttons.

Setting the tempo value directly

Simultaneously hold down both the TEMPO UP and TEMPO DOWN buttons and press the appropriate key (E♭5 - G6) corresponding to the desired tempo.

Stylings

2. Start the Pianist style

The Pianist accompaniment starts automatically when you play a key or chord in the left-hand (accompaniment) section of the keyboard. You can perform along with the professional accompaniment by playing the melody with your right hand.

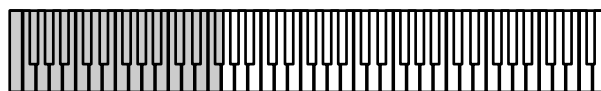

Accompaniment Section

About accompaniment fingering

You can "play" the Pianist accompaniment with one of two different methods: Single Finger or Fingered Chord.

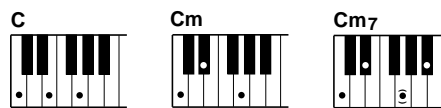
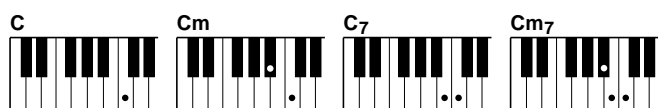

With Single Finger, you can change to the desired chords by playing simple one-, two- or three-finger chord indications.

With Fingered Chord, you can change chords by playing all the notes of the chord, with conventional voicing and fingering.

NOTE For more information on fingering, see "Multi Fingering" on page 24.

NOTE You can change the Pianist style even if another style is playing.

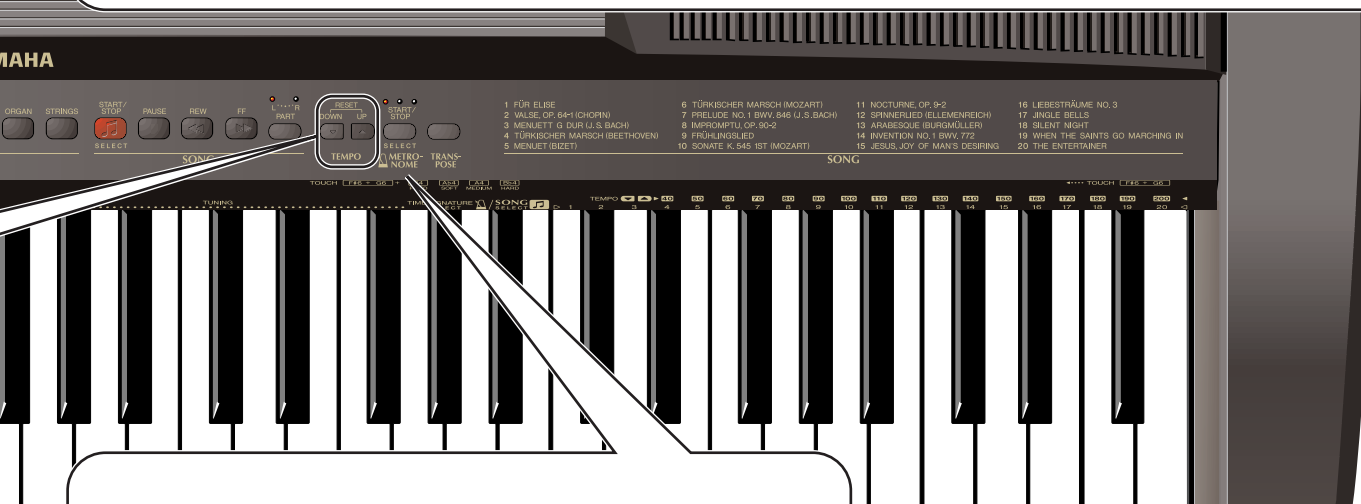

Using the metronome

The metronome is extremely useful, since it helps you stay in time with the Pianist accompaniment. The metronome beats in perfect time with the music, helping you to play more accurately.

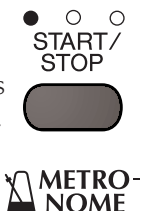

Turning the metronome on/off

To start the metronome at the currently selected tempo, press the METRONOME button. To stop the metronome, press the METRONOME button again.

NOTE The tempo and time signature can be changed. (See pages 15, 22.)

Beat lamps

The Beat lamps flash in time at the currently set tempo and time signature.

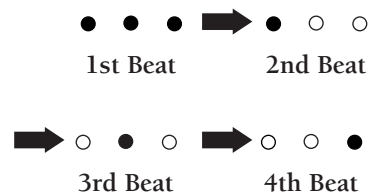

Transpose and Tuning

You can also adjust the tuning and change the transposition (key) of the YPR-50 with the Transpose and Tuning functions.

Transpose

Transpose determines the key of both the main voice and the accompaniment of the selected Pianist style. It also determines the pitch of the songs. This allows you to easily match the pitch of the YPR-50 to other instruments or singers, or play in a different key without changing your fingering. The Transpose settings can be adjusted over a range of +/- 6 semitones (1 octave).

Operation

Simultaneously hold down the TRANSPOSE button and press the appropriate key in the TRANSPOSE section of the keyboard.

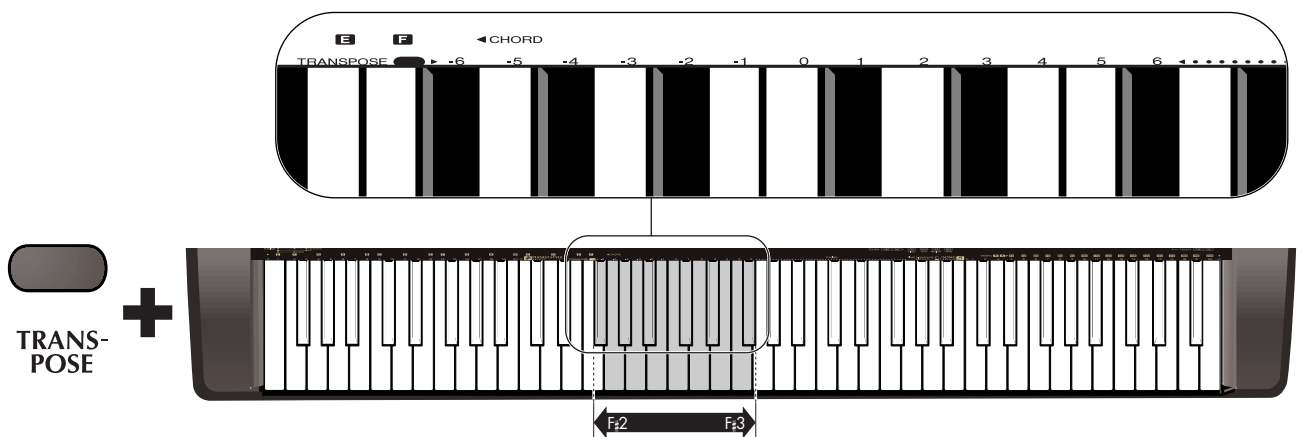

The Transpose values are printed above the keys, indicating the number of semitones up or down from normal pitch. (Normal pitch is "0," at C3.) For example, to raise the transposition by a whole step – so that playing the keyboard in the key of C will actually sound in the key of D – hold down the TRANSPOSE button and press D3.

NOTE The Transpose setting cannot be changed during song playback or when the Pianist feature is on.

NOTE If you use the transpose function during song playback, the octave register of some notes may be different than the original.

Tuning

Tuning determines the fine pitch setting of both the main voice and the accompaniment of the selected Pianist style. It also determines the pitch of the songs. This allows you to accurately match the tuning with that of other instruments. The Tuning settings can be adjusted over a range of +/- 50 (approx. +/- 0.5 semitones).

Operation

Simultaneously hold down the appropriate TUNING control keys (at the left-most side of the keyboard) and press the appropriate key in the TUNING section of the keyboard.

Lowering the pitch:

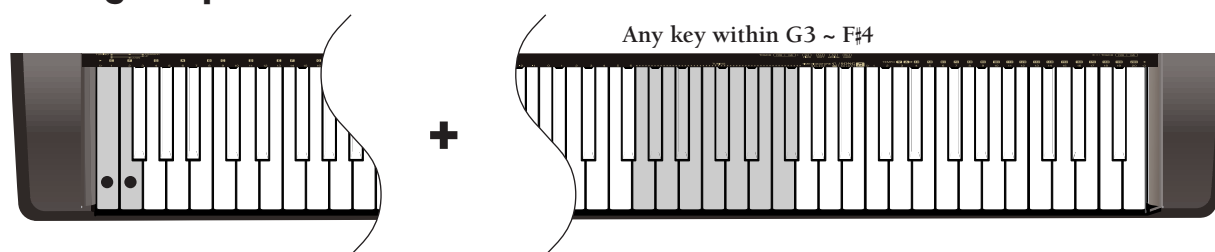

Hold down these keys and press one of the keys in the TUNING section to lower the pitch.

The pitch can be lowered in one-step increments over the TUNING key range of G3 - F#4. The LEDs indicate the amount of detuning from normal pitch (see below).

Raising the pitch:

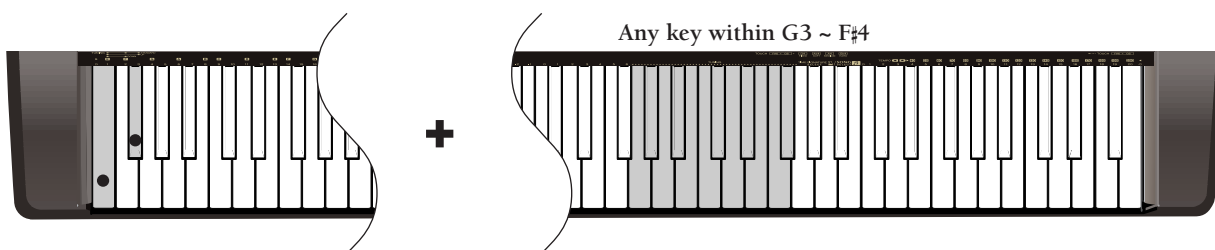

Hold down these keys and press one of the keys in the TUNING section to raise the pitch.

The pitch can be raised in one-step increments over the TUNING key range of G3 - F#4. The LEDs indicate the amount of detuning from normal pitch (see below).

Restoring the normal pitch:

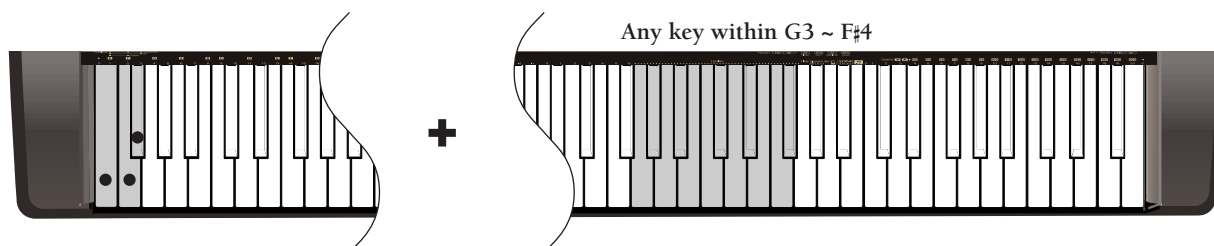

Simultaneously hold down these three keys and press one of the keys in the TUNING section to restore the pitch to normal (0).

Tuning LED indications:

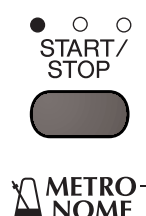

High (sharp)



Normal (in tune)



Low (flat)

LEDs	Tuning value
○ ○ ●	50
○ ● ●	1 ~ 49
○ ● ○	0
● ● ○	-49 ~ -1
● ○ ○	-50

NOTE The Tuning setting cannot be changed when the Pianist feature is on.

Touch Response

The YPR-50 keyboard is equipped with a highly expressive Touch Response function, letting you play the voices with virtually the same dynamic control that you would have on an actual acoustic piano. What's more, the sensitivity of the function can be set to match your own playing style and performance preferences.

Setting the Touch Sensitivity

Touch Sensitivity gives you custom control over the Touch Response feature, by letting you set how the level of the instrument responds to your playing strength. Four different sensitivity types are available.

Operation

Simultaneously hold down the two Touch Sensitivity keys (at the right-most side of the keyboard) and press the appropriate key in the Touch Sensitivity section of the keyboard.

For example, to select SOFT, simultaneously hold down the two highest keys (F#6 and G6) and press A♭4.

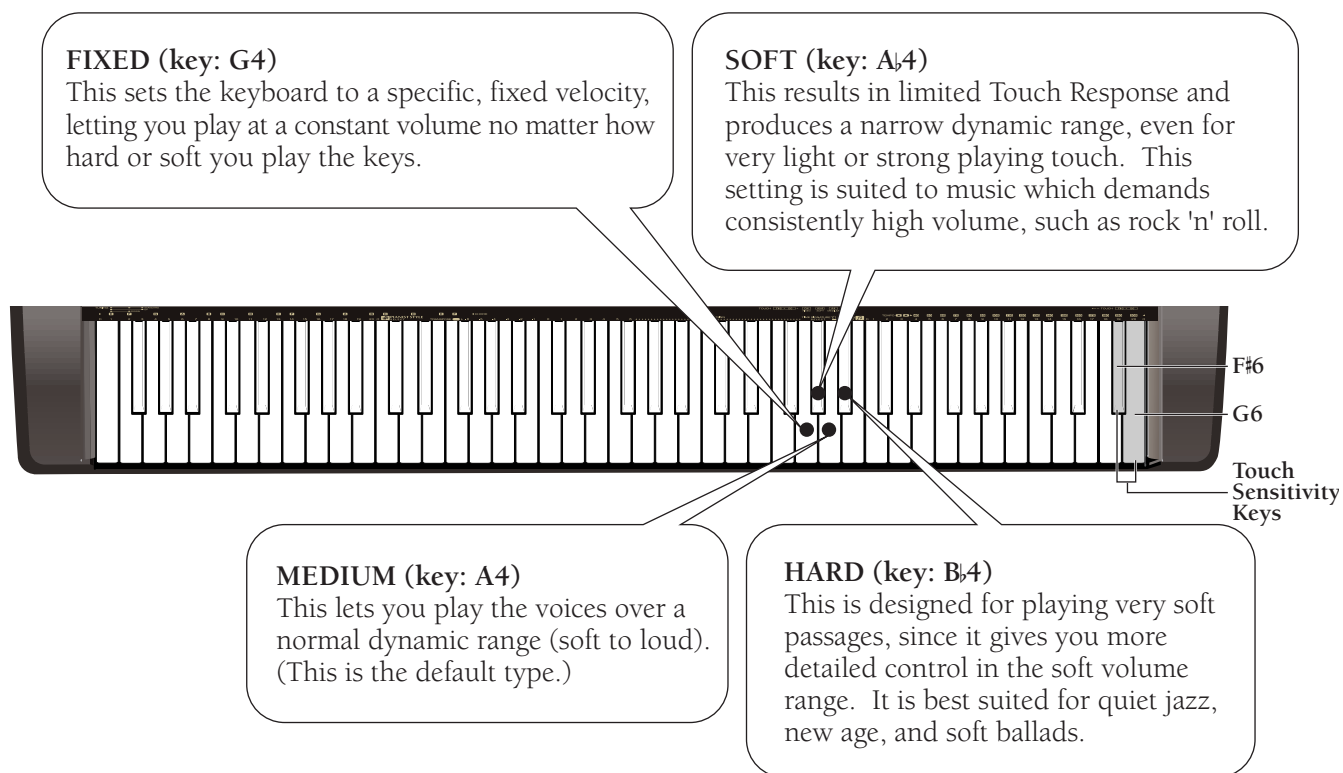

Using the Metronome

The YPR-50 features a built-in metronome for practicing purposes. Both the tempo and the time signature of the metronome click can be set.

Operation

1 Set the desired tempo.

Use the TEMPO DOWN/UP buttons to adjust the tempo. (For more details on changing the tempo, see page 15.) The range is 40 - 240 bpm (beats per minute).

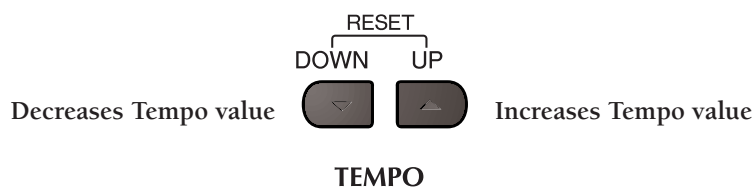

To restore the default tempo, simultaneously press both TEMPO buttons.

2 Turn on the Metronome.

Press the METRONOME START/STOP button.

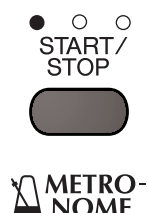

The Beat lamp flashes in time while the metronome is running.

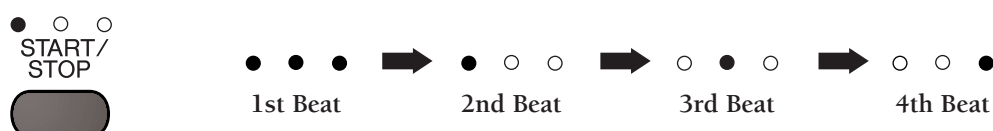

3 To turn the Metronome off, press the METRONOME button again.

Setting the Metronome Time Signature

The time signature of the Metronome can be set to various quarter-note based meters.

NOTE The time signature may change automatically when a Pianist style or song is selected.

Operation

Simultaneously hold down the METRONOME button and press the key that corresponds to the desired time signature (see chart below).

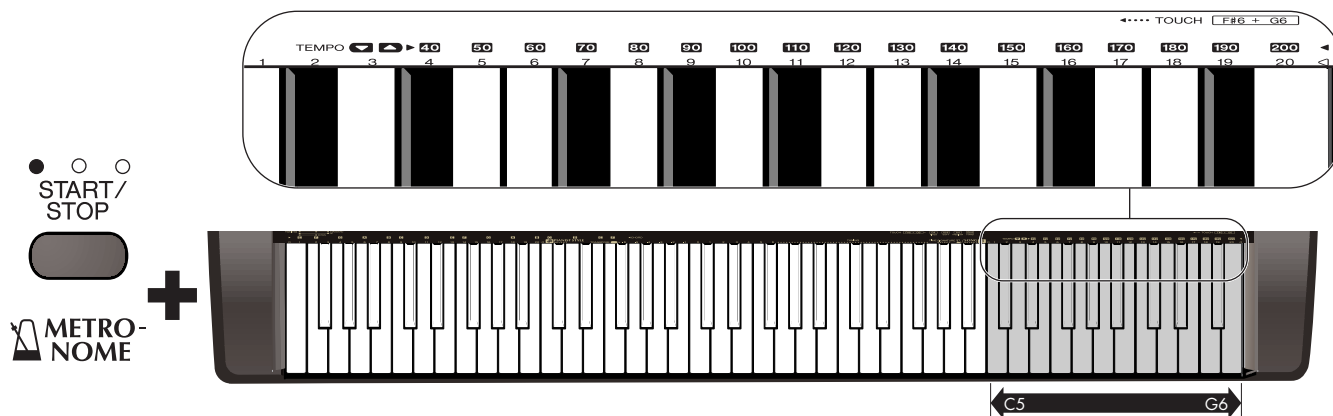

Key	Setting	Time signature
C5	1	Plays only "1" beats (no accents)
C#5	2	2/4
D5	3	3/4
E♭5	4	4/4
E5	5	5/4
F5	6	6/4
F#5	7	7/4
G5	8	8/4
A♭5	9	9/4
A5	10	10/4
B♭5	11	11/4
B5	12	12/4
C6	13	13/4
C#6	14	14/4
D6	15	15/4
E♭6	16	16/4
E6	17	17/4
F6	18	18/4
F#6	19	19/4
G6	20	20/4

The Pianist - Automatic Accompaniment Styles

The powerful Pianist feature provides professional-quality piano accompaniment for your own performances. Simply play the desired chords with your left hand, and the YPR-50 automatically produces stylistically appropriate chords and embellishments for you. This means that you can play simple parts with your left hand (yet sound like a pro!), and concentrate more fully on your right-hand melodies and solos. Twenty different Pianist styles are available.

Selecting a Pianist Style and Playing the Accompaniment

1 Select the desired Pianist style.

Simultaneously hold down the PIANIST STYLE button and press the appropriate key (E0 - B1). The style is automatically set to standby.

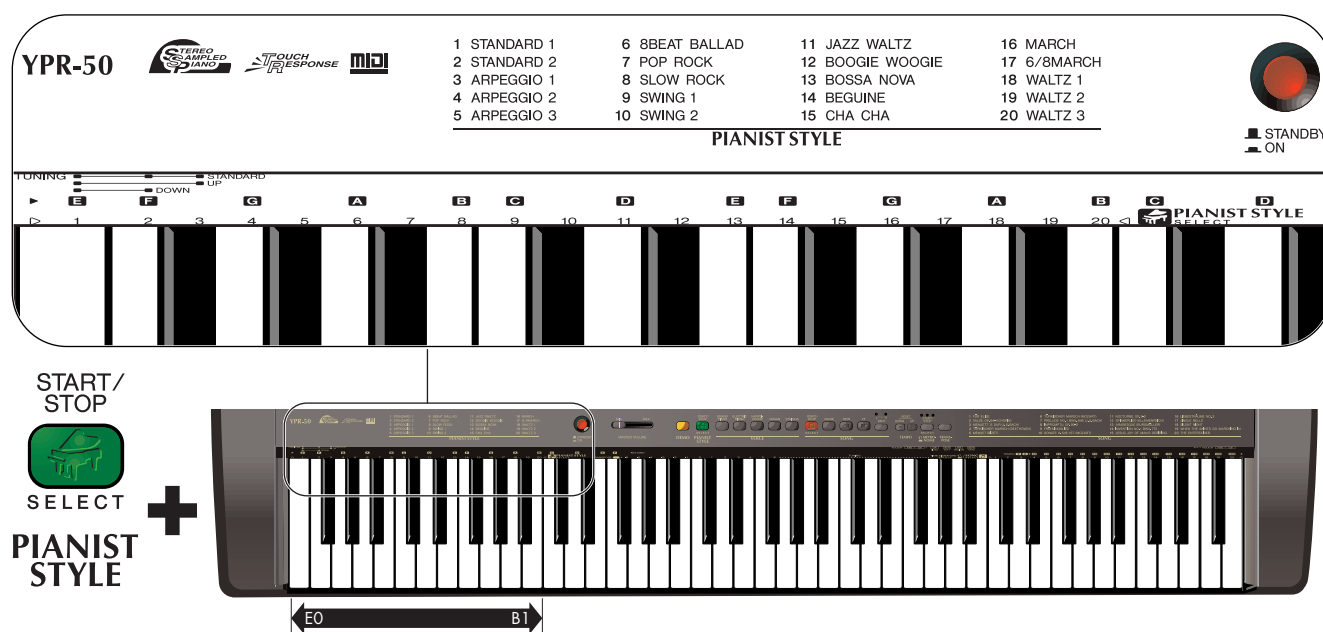

Each Pianist style has its own tempo setting; however, you can change the tempo if desired. See pages 15, 21.

NOTE Pressing only the PIANIST STYLE button (without selecting a style) sets the previously selected style to standby.

NOTE Pressing the PIANIST STYLE button while standby is active turns off the Pianist feature.

2 Start the selected Pianist accompaniment.

The Pianist accompaniment starts automatically when you play a key or chord in the left-hand (accompaniment) section of the keyboard. You can perform along with the accompaniment by playing the melody with your right hand.

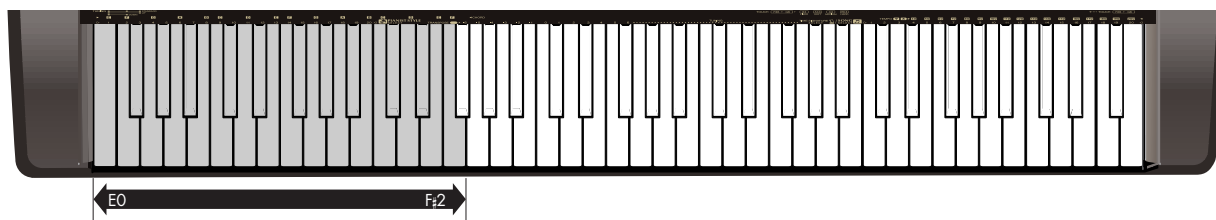

For details on playing the accompaniment chords, see "Using the Pianist Accompaniment – Multi Fingering" below.

NOTE You can change the Pianist style even if another style is playing.

3 Stop the accompaniment.

Press the PIANIST STYLE or START/STOP button. The accompaniment stops with a short pattern.

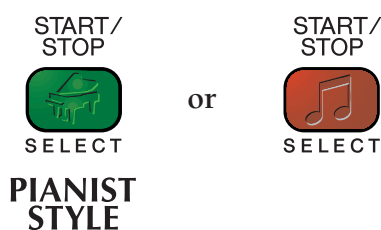

Using the Pianist Accompaniment – Multi Fingering

Pianist feature automatically generates professional-quality piano accompaniment for you to play along with, by using Multi Fingering operation.

To change the chords of the accompaniment, simply play the appropriate keys in the CHORD section of the keyboard (E0 - F#2) using either the "Single Finger" or "Fingered" method. With Single Finger you can simply play a one-, two- or three-finger chord indication (see Single Finger Chords below). The Fingered technique is that of conventionally playing all the notes of the chord. Whichever method you use, the YPR-50 "understands" what chord you indicate and then automatically generates the accompaniment.

Single Finger Chords

Chords that can be produced in Single Finger operation are major, minor, seventh and minor seventh. The illustration below shows how to produce the four chord types. (The key of C is used here as an example; other keys follow the same rules. For example, B \flat 7 is played as B \flat and A.)



To play a major chord: Press the root note of the chord.



To play a minor chord: Press the root note together with any black key to the left of it.



To play a seventh chord: Press the root note together with any white key to the left of it.



To play a minor seventh chord: Press the root note together with any white and black keys to the left of it (three keys altogether).

Fingered Chords

Using the key of C as an example, the chart below shows the types of chords that can be recognized in the Fingered mode.

Fingered Chords in the Key of C

C 	Cm 	Caug (7aug) 	Cdim (dim7)
Csus4 	C7 	Cm7 	CM7
CmM7 	C7^b5 	Cm7^b5 	C7sus4
Cm6 	C(9) 		

Notes enclosed in parentheses are optional; the chords will be recognized without them.

NOTE If the chord is inverted (i.e., C-E-G is played as G-C-E), the YPR-50 will still recognize it as a C chord. The chord recognition system also has the following rules and exceptions:

- Minor 6th chords are recognized only in root position, however; all other inversions are interpreted as minor 7th/ flatted 5th.
- If augmented and diminished 7th chords are inverted, the lowest note will be recognized as the root.
- 7th flatted 5th chords may be played with the lowest note as the root or the flatted 7th.
- Augmented 7th and diminished 7th chords are interpreted as simple augmented and diminished.

Song Controls

The YPR-50 features various song controls, including "transport" buttons (such as REW and FF) and Part on/off control that lets you selectively and independently play back the left- or right-hand parts of a song.

Song "transport" buttons

These convenient buttons let you control song playback just as you would on a CD player or tape deck.

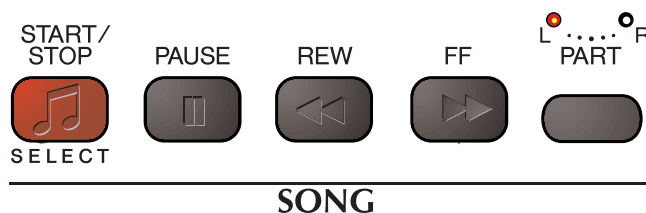

START/STOP, SELECT

With the songs, this button is used for two different functions: 1) to select a specific song, and 2) to start/stop playback of the selected song. Also, when a Pianist style is playing, it can be used to stop the Pianist style.

Selecting a song

Simultaneously hold down the SONG SELECT button and press the appropriate key (C5 - G6, as indicated on the panel) to select the desired song. The selected song starts playing back as soon as you release the SONG button. To stop the song, press the SONG button again.

Starting and stopping playback of a selected song

Press the SONG START/STOP button to start playback of the selected song. While a song is playing back, press this button to stop playback.

PAUSE

Pressing this pauses playback of the song at the current point in the song. Press the PAUSE button again to resume playback of the song from the paused point.

REW (Rewind)

Hold this button down during song playback to move measure-by-measure in reverse through the song. The song automatically starts playing back from the selected point as soon as the REW button is released.

FF (Fast Forward)

Hold this button down during song playback to fast forward through the song. The song automatically starts playing back from the selected point as soon as the FF button is released.

NOTE The REW and FF buttons can also be used when playback is paused; to start playback again from the selected position, press the SONG button. (In this case, the PAUSE button cannot be used to start playback.)

NOTE The song cannot be heard when holding down the REW button.

Part on/off control

The YPR-50 lets you independently play back the left-hand and right-hand parts of the songs. For example, you may want have only the left-hand accompaniment part sound while you practice the melody part with your right hand.

Pressing the PART button switches among the following three Part On/Off settings:

- Both parts are on (default)
- Only the left part is on – letting you play the other part with your right hand
- Only the right part is on – letting you play the other part with your left hand

The Part lamps indicate which part is selected and active.



Both parts can be heard.

Only the left part can be heard.

Only the right part can be heard.



NOTE The Part setting can be changed even during song playback.

NOTE Pressing the PART button during Demo song playback automatically cancels the Demo mode and switches to Song mode.

MIDI

The YPR-50 also features MIDI terminals, allowing you to interface the YPR-50 with other MIDI instruments and devices.

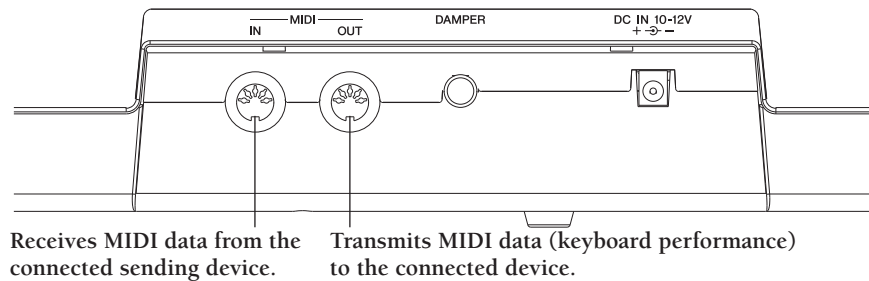

About MIDI

MIDI (Musical Instrument Digital Interface) is a worldwide standard that is built into many electronic musical instruments and other digital music related devices, allowing them to be connected and "communicate" with each other. For two MIDI instruments to communicate, they must be connected by MIDI cables. In a basic example, the MIDI IN and MIDI OUT terminals of the YPR-50 could be connected to the MIDI OUT and MIDI IN terminals of a sequencer, allowing you to record and play back performance data from the YPR-50.

The instruments communicate with each other by sending "messages" or MIDI data. The sending instrument usually assigns the data to one of sixteen MIDI channels, then transmits it over the MIDI cable. The cable itself, however, is not divided up into sixteen channels. Just as with a television set that receives programs on different channels, it is up to the receiving instrument to "tune into" the proper MIDI channel. If the sending and receiving channels on the respective instruments do not match, the receiving instrument may not understand or respond to the one sending.

How Can MIDI be Used?

In the simple, yet powerful MIDI application example below, the sequencer is used to record and play back performance data played on the YPR-50 keyboard.

Before actually recording to the sequencer, press the PIANIST STYLE button to make sure that the current settings are sent. When the data is played back from the sequencer, the YPR-50 will sound with the exact same settings as you used during recording.

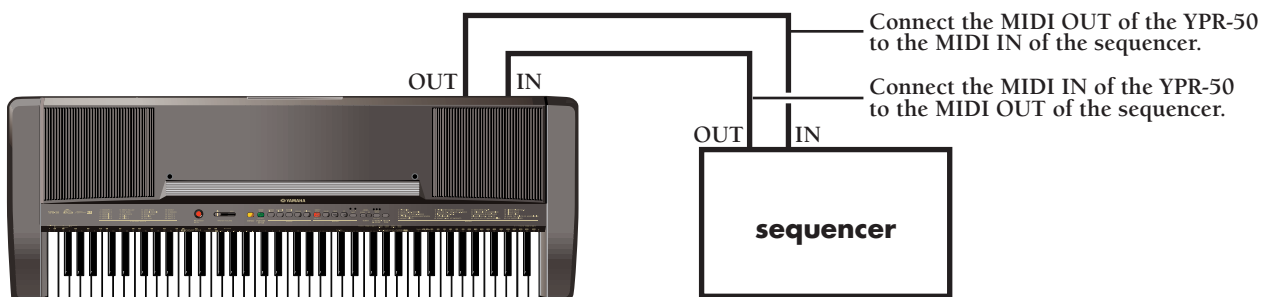

- NOTE**
- On the YPR-50, the following channels (seven total) are enabled for MIDI reception: 1, 2, 3, 4, 5, 6, 7. The MIDI transmit channels are fixed to the following data:
 - Ch. 1 : Keyboard
 - Ch. 2 : Bass
 - Ch. 3 : Chord
 - Ch. 4 - 7 : Other
 - Parts that have been recorded using the YPR-50 should also be played back from the YPR-50. Data may not play back as expected when using other sound sources (such as the internal sounds of the sequencer). Also, a connected sound source may sound at a different octave from that originally played on the YPR-50.
 - MIDI data cannot be transmitted during song playback.
 - Avoid using MIDI cables 15 meters or longer, since doing so can result in MIDI errors.

PIANIST STYLE Default Tempos

PIANIST STYLE	DEFAULT TEMPO
Standard1	108
Standard2	108
Arpeggio1	64
Arpeggio2	112
Arpeggio3	88
8Beat Ballad	68
Pop Rock	116
Slow Rock	64
Swing1	152
Swing2	152
Jazz Waltz	120
BoogieWoogie	160
Bossa Nova	140
Beguine	120
Cha Cha	124
March	120
6/8 March	120
Waltz1	160
Waltz2	88
Waltz3	116

Troubleshooting

Problem	Possible Cause and Solution
When the YPR-50 is turned on or off, a popping sound is temporarily produced.	This is normal and indicates that the YPR-50 is receiving electrical power.
When using a mobile phone, noise is produced.	Using a mobile phone in close proximity to the YPR-50 may produce interference. To prevent this, turn off the mobile phone or use it further away from the YPR-50.
The sound of the voices or rhythms seems unusual or strange.	The battery power is too low. Replace the batteries. (See page 8.)
There is no sound even when the keyboard is played or when a Song is being played back.	Check that nothing is connected to the PHONES/OUTPUT jack on the rear panel. When a set of headphones is plugged into this jack, no sound is output.
Not all notes are heard when playing a number of notes simultaneously.	Too many keys are pressed at the same time. The YPR-50 is polyphonic up to a maximum of 32 notes.
The sound of the voice changes from note to note.	The AWM tone generation method uses multiple recordings (samples) of an instrument across the range of the keyboard; thus, the actual sound of the voice may be slightly different from note to note.

Keyboard Stand Assembly Instructions

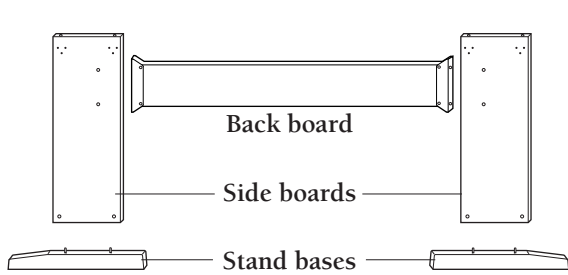

① 6 x 70 mm round head screws (4 pcs.)

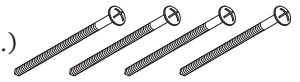

② Joint connectors (4 pcs.)



③ 3.5 x 16 mm tapping screws (12 pcs.)



④ 6 x 30 mm round head screws (4 pcs.)



⑤ 5 x 16 mm round head screws (4 pcs.)



⑥ Angle brackets (4 pcs.)

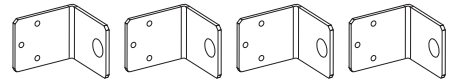

CAUTION

Be careful not to interchange any of the parts, and make sure to install all parts in the correct direction. Also, carefully follow the instruction steps in the order given.

Make sure to use the correct screw sizes, as indicated above.

Using the screws incorrectly can result in damage to the stand.

After assembly, make sure all screws have been properly tightened.

To disassemble the stand, simply remove each part in the reverse order of the instruction steps.

① Open the box and remove all the parts.

Inside the box you should find all the parts shown in the illustration above. Check to make sure that all the necessary parts have been included.

② Use a standard phillips screwdriver for assembly.

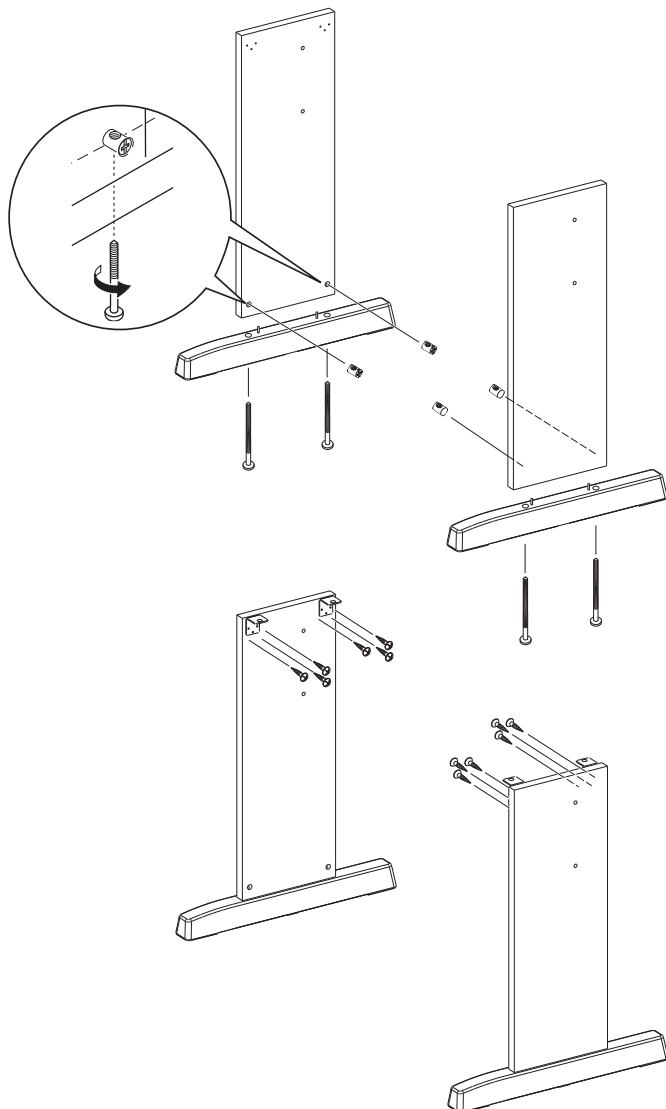
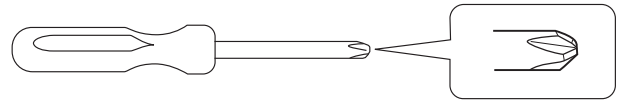

③ Attach the stand bases.

Making sure that the boards are facing the proper direction (the holes should face inside), insert the joint connectors ② into the holes as shown. The joint connectors have been installed properly if you can see a plus mark on the connector.

Attach the stand bases to the rear of the side boards, using the 6 x 70 mm round head screws ①.

④ Attach the angle brackets.

Attach the angle brackets ⑥ to the side boards using the 3.5 x 16 mm tapping screws ③.

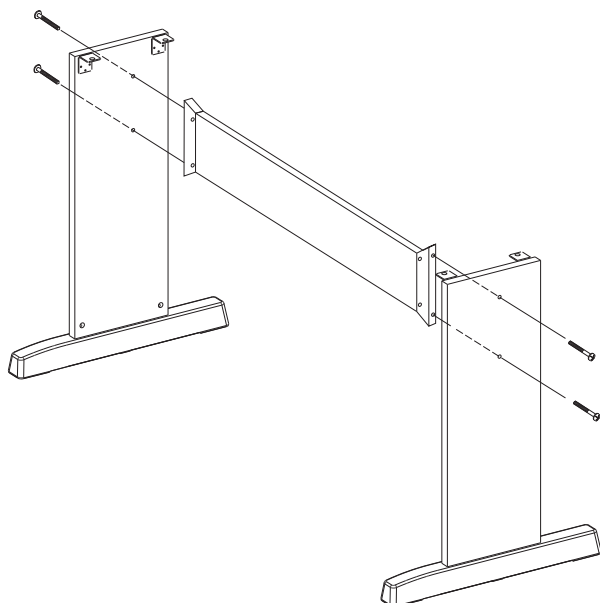

- 5 Attach the back board.**
Attach the back board, using the 6 x 30 mm round head screws **4**.

**CAUTION**

Be careful not to drop the back board or touch the sharp metal fittings.

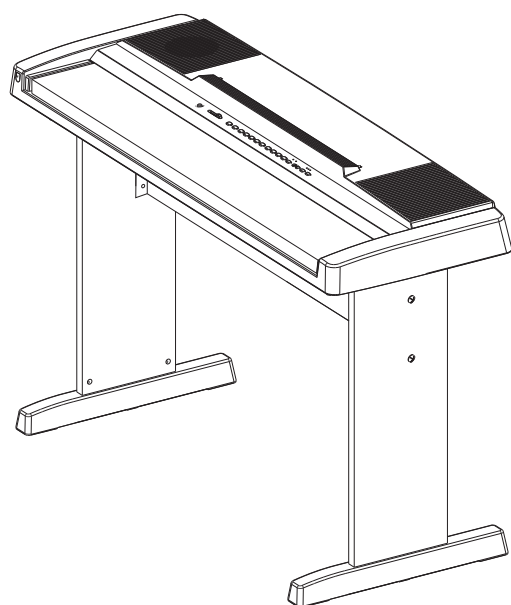

- 6 Put the keyboard on the stand.**
Carefully place the keyboard on the side panels. Slowly move the keyboard so that the holes on the bottom of the keyboard are properly aligned with the holes on the angle brackets.

**CAUTION**

Be careful not to drop the keyboard or to get your fingers caught between the keyboard and the stand parts.

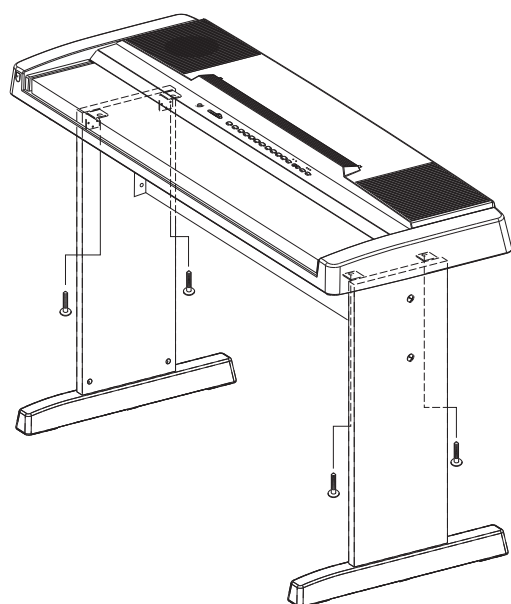

- 7 Install the keyboard to the stand.**
Fix the keyboard to the angle brackets, using the 5 x 16 mm round head screws **5**.

Post-assembly checklist
.....

Once you've assembled the stand, check the following points:

- Are there any parts left over?
- If so, read the assembly instructions again and correct any errors you might have made.
- Is the instrument clear of doors and other movable fixtures?
- If not, move the instrument to an appropriate location.
- Does the instrument make a rattling noise when you play it or move it?
- If so, properly tighten all screws.
- Also, if the keyboard makes a creaking noise or seems unsteady when you play it, refer carefully to the assembly instructions and diagrams and retighten all screws.

Specifications

Keyboard

76 standard-size keys (E0 - G6) with touch response

Voices

5 panel voices (max. polyphony: 32)

Pianist Style

20 styles

Fingering: Multi Fingering

Overall controls

Transpose, Tuning, Touch Sensitivity

Style controls

Start, Stop, Select

Song controls

Start, Stop, Pause, Fast Forward, Rewind, Part

Panel controls

DEMO, Tempo up, Tempo down
Metronome, Start, Stop

Preset songs

20 songs

Amplifier

3.0W + 3.0W

MIDI

IN/OUT

Auxiliary jacks

PHONES/OUTPUT, DC IN 10-12V, MIDI
IN/OUT, DAMPER

Speakers

12cm x 2

Power consumption

UL/CSA 6.6W (when using PA-3B power adaptor)
CE 7.3W (when using PA-3B power adaptor)

Power supply

Adaptor: Yamaha PA-3B AC power adaptor
Rated Voltage DC 10-12V
Rated Current 700mA
Batteries: Six "D" size, SUM-1, R-20 or
equivalent batteries

Dimensions

1188 x 780 x 485 mm
(W x H x D, including the Keyboard stand)
(46-3/4" x 30-3/4" x 19-1/8")

1188 X 138 X 435 mm
(W x H x D, not including the Keyboard stand)
(46-3/4" x 5-7/16" x 17-1/8")

Weight

13.8 Kg (including the Keyboard stand)
(30 lbs.,7 oz.)

7.5 Kg (not including the Keyboard stand)
(16 lbs.,9 oz.)

Supplied accessories

Music Stand, Owner's Manual, Song Book,
Footswitch FC-5, Keyboard Stand

Optional accessories

Headphones:	HPE-150
AC power adaptor:	PA-3B
Footswitch:	FC-4

* Specifications and descriptions in this owner's manual are for information purposes only. Yamaha Corp. reserves the right to change or modify products or specifications at any time without prior notice. Since specifications, equipment or options may not be the same in every locale, please check with your Yamaha dealer.

MIDI Implementation Chart

[Portable Keyboard] / Model: YPR-50

Date: 10. May 1999
Version: 1.0

Function		Transmit	Receive	Remarks
Basic Channel	Default Changed	1-7,10 X	1-7,10 X	
Mode	Default Messages Altered	3 X *****	3 X X	
Note Number	True Voice	0-127 *****	0-127 0-127	
Velocity	Note ON Note OFF	○ 9nH, v=1-127 *1 ○ 9nH, v=0	○ 9nH, v=1-127 ○ 9nH, v=0 or 8nH	
After Touch	Key's Ch's	X X	X X	
Pitch Bend		X	X	
Control Change	0, 32 1 6, 38 7 10 11 64 66 84 91 96 97 100, 101 120 121	○ *2 X X ○ ○ X ○ X ○ X X X X X X X	○ *2 X X ○ ○ X ○ X ○ X X X X X X	Bank Select MSB, LSB Modulation Depth Data Entry MSB, LSB Volume Pan Expression Sustain Sostenuto Portamento Controllers Reverb Depth RPN Inc RPN Dec RPN LSB, MSB All Sound Off Reset All Controllers
Program Change	Change : True #	X *2 *****	○ *2 *2	
System Exclusive		○ *3	○ *3	
System Common	: Song Position : Song Select : Tune	X X X	X X X	
System Real Time	Clock Commands	X X	X X	
Aux Messages	Local ON/OFF All Notes OFF Active Sense Reset	X X ○ X	X X ○ X	
Notes	<p>*1 Depending on the selected voice, the transmitted velocity value may differ, even for notes played with identical strength. *2 Program change and other like channel messages received will not affect the YPR-50 panel settings or what is being played on the keyboard. *3 < GM System on > F0H, 7EH, 7FH, 09H, 01H, F7H All data is restored to the default values. *4 MIDI does not function (transmit/receive) during song playback.</p>			

Mode 1 : OMNI ON, POLY
Mode 3 : OMNI OFF, POLY

Mode 2 : OMNI ON, MONO
Mode 4 : OMNI OFF, MONO

○ : Yes
X : No

Limited Warranty

90 DAYS LABOR

1 YEAR PARTS

Yamaha Corporation of America, hereafter referred to as Yamaha, warrants to the original consumer of a product included in the categories listed below, that the product will be free of defects in materials and/or workmanship for the periods indicated. This warranty is applicable to all models included in the following series of products:

YPR SERIES OF PORTATONE ELECTRONIC KEYBOARDS

If during the first 90 days that immediately follows the purchase date, your new Yamaha product covered by this warranty is found to have a defect in material and/or workmanship, Yamaha and/or its authorized representative will repair such defect without charge for parts or labor.

If parts should be required after this 90 day period but within the one year period that immediately follows the purchase date, Yamaha will, subject to the terms of this warranty, supply these parts without charge. However, charges for labor, and/or any miscellaneous expenses incurred are the consumers responsibility. Yamaha reserves the right to utilize reconditioned parts in repairing these products and/or to use reconditioned units as warranty replacements.

THIS WARRANTY IS THE ONLY EXPRESS WARRANTY WHICH YAMAHA MAKES IN CONNECTION WITH THESE PRODUCTS. ANY IMPLIED WARRANTY APPLICABLE TO THE PRODUCT, INCLUDING THE WARRANTY OF MERCHANT ABILITY IS LIMITED TO THE DURATION OF THE EXPRESS WARRANTY. YAMAHA EXCLUDES AND SHALL NOT BE LIABLE IN ANY EVENT FOR INCIDENTAL OR CONSEQUENTIAL DAMAGES.

Some states do not allow limitations that relate to implied warranties and/or the exclusion of incidental or consequential damages. Therefore, these limitations and exclusions may not apply to you.

This warranty gives you specific legal rights. You may also have other rights which vary from state to state.

CONSUMERS RESPONSIBILITIES

If warranty service should be required, it is necessary that the consumer assume certain responsibilities:

1. Contact the Customer Service Department of the retailer selling the product, or any retail outlet authorized by Yamaha to sell the product for assistance. You may also contact Yamaha directly at the address provided below.
2. Deliver the unit to be serviced under warranty to: the retailer selling the product, an authorized service center, or to Yamaha with an explanation of the problem. Please be prepared to provide proof purchase date (sales receipt, credit card copy, etc.) when requesting service and/or parts under warranty.
3. Shipping and/or insurance costs are the consumers responsibility.* Units shipped for service should be packed securely.

*Repaired units will be returned PREPAID if warranty service is required within the first 90 days.

IMPORTANT: Do NOT ship anything to ANY location without prior authorization. A Return Authorization (RA) will be issued that has a tracking number assigned that will expedite the servicing of your unit and provide a tracking system if needed.

4. Your owners manual contains important safety and operating instructions. It is your responsibility to be aware of the contents of this manual and to follow all safety precautions.

EXCLUSIONS

This warranty does not apply to units whose trade name, trademark, and/or ID numbers have been altered, defaced, exchanged removed, or to failures and/or damages that may occur as a result of:

1. Neglect, abuse, abnormal strain, modification or exposure to extremes in temperature or humidity.
2. Improper repair or maintenance by any person who is not a service representative of a retail outlet authorized by Yamaha to sell the product, an authorized service center, or an authorized service representative of Yamaha.
3. This warranty is applicable only to units sold by retailers authorized by Yamaha to sell these products in the U.S.A., the District of Columbia, and Puerto Rico. This warranty is not applicable in other possessions or territories of the U.S.A. or in any other country.

Please record the model and serial number of the product you have purchased in the spaces provided below.

Model _____ Serial # _____ Sales Slip # _____

Purchased from _____ Date _____
(Retailer)

YAMAHA CORPORATION OF AMERICA
Electronic Service Division
6600 Orangethorpe Avenue
Buena Park, CA 90620

KEEP THIS DOCUMENT FOR YOUR RECORDS. DO NOT MAIL!

For details of products, please contact your nearest Yamaha or the authorized distributor listed below.

Pour plus de détails sur les produits, veuillez-vous adresser à Yamaha ou au distributeur le plus proche de vous figurant dans la liste suivante.

Die Einzelheiten zu Produkten sind bei Ihrer unten aufgeführten Niederlassung und bei Yamaha Vertragshändlern in den jeweiligen Bestimmungsländern erhältlich.

Para detalles sobre productos, contacte su tienda Yamaha más cercana o el distribuidor autorizado que se lista debajo.

NORTH AMERICA

CANADA

Yamaha Canada Music Ltd.
135 Milner Avenue, Scarborough, Ontario,
M1S 3R1, Canada
Tel: 416-298-1311

U.S.A.

Yamaha Corporation of America
6600 Orangethorpe Ave., Buena Park, Calif. 90620,
U.S.A.
Tel: 714-522-9011

CENTRAL & SOUTH AMERICA

MEXICO

**Yamaha de Mexico S.A. De C.V.,
Departamento de ventas**
Javier Rojo Gomez No.1149, Col. Gpe Del
Moral, Deleg. Iztapalapa, 09300 Mexico, D.F.
Tel: 686-00-33

BRAZIL

Yamaha Musical do Brasil LTDA.
Av. Rebouças 2636, São Paulo, Brasil
Tel: 011-853-1377

ARGENTINA

Yamaha Music Argentina S.A.
Viamonte 1145 Piso 2-B 1053,
Buenos Aires, Argentina
Tel: 1-371-7021

PANAMA AND OTHER LATIN AMERICAN COUNTRIES/ CARIBBEAN COUNTRIES

Yamaha de Panama S.A.
Torre Banco General, Piso 7, Urbanización Marbella,
Calle 47 y Aquilino de la Guardia,
Ciudad de Panamá, Panamá
Tel: 507-269-5311

EUROPE

THE UNITED KINGDOM

Yamaha-Kemble Music (U.K.) Ltd.
Sherbourne Drive, Tilbrook, Milton Keynes,
MK7 8BL, England
Tel: 01908-366700

IRELAND

Danfay Ltd.
61D, Sallynoggin Road, Dun Laoghaire, Co. Dublin
Tel: 01-2859177

GERMANY/SWITZERLAND

Yamaha Europa GmbH.
Siemensstraße 22-34, 25462 Rellingen,
F.R. of Germany
Tel: 04101-3030

AUSTRIA

Yamaha Music Austria
Schleiergasse 20, A-1100 Wien Austria
Tel: 01-60203900

THE NETHERLANDS

Yamaha Music Nederland
Kanaalweg 18G, 3526KL, Utrecht, The Netherlands
Tel: 030-2828411

BELGIUM

Yamaha Music Belgium
Keiberg Imperiastraat 8, 1930 Zaventem, Belgium
Tel: 02-7258220

FRANCE

**Yamaha Musique France,
Division Claviers**
BP 70-77312 Marne-la-Vallée Cedex 2, France
Tel: 01-64-61-4000

ITALY

**Yamaha Musica Italia S.P.A.,
Home Keyboard Division**
Viale Italia 88, 20020 Lainate (Milano), Italy
Tel: 02-935-7711

SPAIN/PORTUGAL

Yamaha-Hazen Electronica Musical, S.A.
Jorge Juan 30, 28001, Madrid, Spain
Tel: 91-577-7270

GREECE

Philippe Nakas S.A.
Navarinou Street 13, P.Code 10680, Athens, Greece
Tel: 01-364-7111

SWEDEN

Yamaha Scandinavia AB
J. A. Wettergrens Gata 1
Box 30053
S-400 43 Göteborg, Sweden
Tel: 031 89 34 00

DENMARK

YS Copenhagen Liaison Office
Generatorvej 8B
DK-2730 Herlev, Denmark
Tel: 44 92 49 00

FINLAND

F-Musiikki Oy
Kluuvikatu 6, P.O. Box 260,
SF-00101 Helsinki, Finland
Tel: 09 618511

NORWAY

Norsk filial av Yamaha Scandinavia AB
Grini Næringspark 1
N-1345 Østerås, Norway
Tel: 67 16 77 70

ICELAND

Skeifan HF
Skeifan 17 P.O. Box 8120
IS-128 Reykjavik, Iceland
Tel: 525 5000

OTHER EUROPEAN COUNTRIES

Yamaha Europa GmbH.
Siemensstraße 22-34, 25462 Rellingen, F.R. of
Germany
Tel: 04101-3030

AFRICA

**Yamaha Corporation,
International Marketing Division**
Nakazawa-cho 10-1, Hamamatsu, Japan 430-8650
Tel: 053-460-2312

MIDDLE EAST

TURKEY/CYPRUS

Yamaha Europa GmbH.
Siemensstraße 22-34, 25462 Rellingen,
F.R. of Germany
Tel: 04101-3030

OTHER COUNTRIES

Yamaha Music Gulf FZE
LB21-128 Jebel Ali Freezone
P.O.Box 17328, Dubai, U.A.E.
Tel: 971-4-81-5868

ASIA

HONG KONG

Tom Lee Music Co., Ltd.
11/F., Silvercord Tower 1, 30 Canton Road,
Tsimshatsui, Kowloon, Hong Kong
Tel: 2737-7688

INDONESIA

**PT. Yamaha Music Indonesia (Distributor)
PT. Nusantik**
Gedung Yamaha Music Center, Jalan Jend. Gatot
Subroto Kav. 4, Jakarta 12930, Indonesia
Tel: 21-520-2577

KOREA

Cosmos Corporation
1461-9, Seocho Dong, Seocho Gu, Seoul, Korea
Tel: 02-3486-0011

MALAYSIA

Yamaha Music Malaysia, Sdn., Bhd.
Lot 8, Jalan Perbandaran, 47301 Kelana Jaya,
Petaling Jaya, Selangor, Malaysia
Tel: 3-703-0900

PHILIPPINES

Yupango Music Corporation
339 Gil J. Puyat Avenue, P.O. Box 885 MCPO,
Makati, Metro Manila, Philippines
Tel: 819-7551

SINGAPORE

Yamaha Music Asia Pte., Ltd.
11 Ubi Road #06-00, Meiban Industrial Building,
Singapore
Tel: 65-747-4374

TAIWAN

Yamaha KHS Music Co., Ltd.
10F, 150, Tun-Hwa Northroad,
Taipei, Taiwan, R.O.C.
Tel: 02-2713-8999

THAILAND

Siam Music Yamaha Co., Ltd.
121/60-61 RS Tower 17th Floor,
Ratchadaphisek RD., Dindaeng,
Bangkok 10320, Thailand
Tel: 02-641-2951

THE PEOPLE'S REPUBLIC OF CHINA AND OTHER ASIAN COUNTRIES

**Yamaha Corporation,
International Marketing Division**
Nakazawa-cho 10-1, Hamamatsu, Japan 430-8650
Tel: 053-460-2317

OCEANIA

AUSTRALIA

Yamaha Music Australia Pty. Ltd.
17-33 Market Street, South Melbourne, Vic. 3205,
Australia
Tel: 3-699-2388

NEW ZEALAND

Music Houses of N.Z. Ltd.
146/148 Captain Springs Road, Te Papapa,
Auckland, New Zealand
Tel: 9-634-0099

COUNTRIES AND TRUST TERRITORIES IN PACIFIC OCEAN

**Yamaha Corporation,
International Marketing Group**
Nakazawa-cho 10-1, Hamamatsu, Japan 430-8650
Tel: 053-460-2312

HEAD OFFICE Yamaha Corporation, Electronic Musical Instrument Division
Nakazawa-cho 10-1, Hamamatsu, Japan 430-8650
Tel: 053-460-3273

