

Thank you for selecting this YAMAHA Soavo-1 speaker system.

PRECAUTIONS

Read this before using the speakers.

- To assure the finest performance, please read this manual carefully. Keep it in a safe place for future reference.
- Install the speakers in a cool, dry, clean place – away from windows, heat sources, sources of excessive vibration, dust, moisture and cold. Avoid sources of humming (transformers, motors). To prevent fire or electrical shock, do not expose the speakers to rain or water.
- To prevent the enclosure from warping or discoloring, do not place the speakers where they will be exposed to direct sunlight or excessive humidity.
- Do not place the following objects on the speakers:
Glass, china, etc.
If glass etc. falls by vibrations and breaks, it may cause personal injury.
A burning candle etc.
If the candle falls by vibrations, it may cause fire and personal injury.
A vessel with water in it
If the vessel falls by vibrations and water spills, it may cause damage to the speakers, and/or you may get an electric shock.
- Do not place the speakers where foreign objects such as water drips might fall. It might cause a fire, damage to the speakers, and/or personal injury.
- Do not place the speaker where it is liable to be knocked over or struck by falling objects. Stable placement will also ensure better sound performance.
- Placing the speakers on the same shelf or rack as the turntable can result in feedback.
- Never put a hand or a foreign object into the port located on the front of the speaker as this might cause personal injury and/or damage to the speaker.
- When moving the speaker, do not hold the port as it might cause personal injury and/or damage to the speaker.
- Any time you note distortion, reduce the volume control on your amplifier to a lower setting. Never allow your amplifier to be driven into “clipping”. Otherwise the speakers may be damaged.
- When using an amplifier with a rated output power higher than the nominal input power of the speakers, care should be taken never to exceed the speakers' maximum input.
- Do not attempt to clean the speakers with chemical solvents as this might damage the finish. Use a clean, dry cloth.
- Do not attempt to modify or fix the speakers. Contact qualified YAMAHA service personnel when any service is needed. The cabinet should never be opened for any reasons.
- As this unit is heavy, whenever it is moved, two people are required to transport it safely.
- **Secure placement or installation is the owner's responsibility.**
YAMAHA shall not be liable for any accident caused by improper placement or installation of speakers.

PRECAUTIONS WHEN POSITIONING

The speaker is constructed with the majority of the weight located in its upper portion, and is thus susceptible to falling over if proper care is not taken to insure its stability. If the speaker falls over, it may damage the speaker or be the cause of injury (or even death) to persons and/or damage to personal property.



For safe and proper use of the speaker:

- Position the speaker in a location that is solid, level, smooth, and low (with respect to the floor).
- Do not push or apply pressure to the side of the speaker when moving, or lean objects against the side of the speaker.
- Do not sit on or set objects on top of the speaker.
- Do not remove the stands attached to the bottom of the speaker as this might cause the serious accidents, resulting from falling over of the speaker.

Vibrations or jolts associated with earthquakes and other phenomena or activities may cause the speaker to fall over. For safety reasons, using commercially available products that increase stability in the speaker is recommended (metal fittings or chains, etc.).

FEATURES

- **Type:** 3-way, 4-speaker bass-reflex floor standing tower speaker for main channels. Aluminum diecast stand included.
- **Woofer:** Dual 16 cm A-PMD cone, **Midrange:** 13 cm A-PMD cone, **Tweeter:** 3 cm Aluminum dome.

PLACING THE SPEAKERS

■ Using as 2ch stereo speakers

Better stereo images will be obtained when the speakers are slightly angled in towards the listeners.

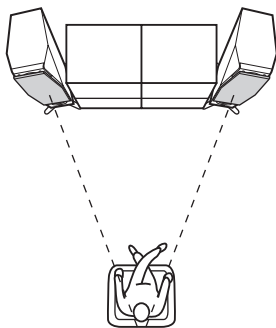

■ Using as front speakers in a multi channel system

Position the speakers on both sides of the TV. The positioning of speakers is important, because it controls the whole sound quality of a multi channel system. Set up the speakers on the basis of your listening position by following the owner's manual supplied with your amplifier.

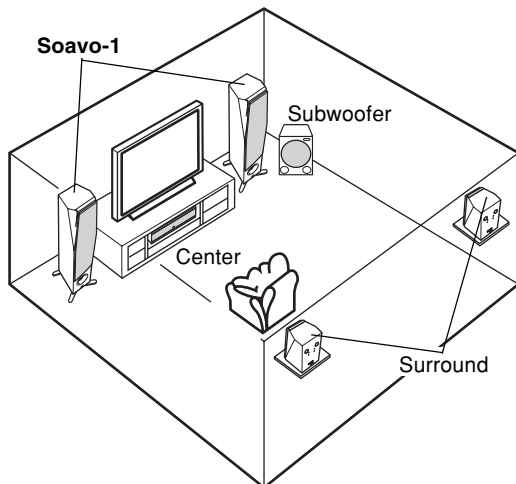

Notes

- These speakers feature a magnetically shielded design, but there is still a chance that placing them too close to a TV set might impair picture color or buzzing noise. Should this happen, move the speakers away from the TV set.
- Do not remove the stands attached to the bottom of the speaker as this might cause the serious accidents, resulting from falling over of the speaker.

When setting up this unit on a thick carpet etc.



Spike x 4



Nut x 4

Attach the spikes at the four point on the speaker stand to increase stability and improve sound quality.

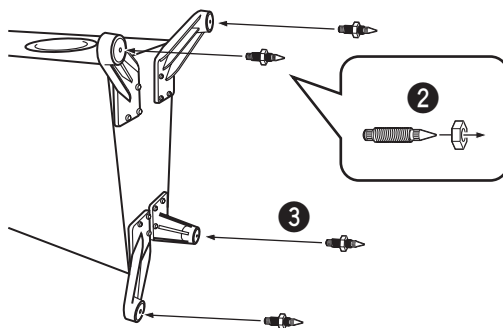

How to attach the spikes:

- 1 Lay down this unit on the floor.
- 2 Turn the nut and position it near the tip of the spike.
- 3 Screw the spikes into the hole of the stands.
- 4 Place the speaker in the desired location in an upright position and adjust the length of the spike to match the depth of the carpet. (repeat step 1, 2 and 3.)
- 5 When adjustment is finished, turn the nut up to the base of the stand firmly.

Notes

- The tips of the spikes may scratch or damage the flooring. Please be careful when positioning the speakers.
- Do not push or lean against the speaker to prevent falling over, which may cause damage to this unit or personal injury.
- As this unit is heavy, whenever it is moved, two people are required to transport it safely.

<Bi-wired connections>

To connect the speaker to the output terminals of the amplifier, two pairs of cables for each of the woofer and the tweeter/mid-range are used instead of standard connections. This type of connection decreases the modulation distortion caused by electric resistance of the cables and driving current of the speakers. Consequently, purer sound quality can be expected.

To utilize bi-wired connections, remove the jumper cables from the terminals first, and then connect the woofer and the tweeter/mid-range to the amplifier separately using two pairs of cables.

When your amplifier has only one set of speaker output terminals.

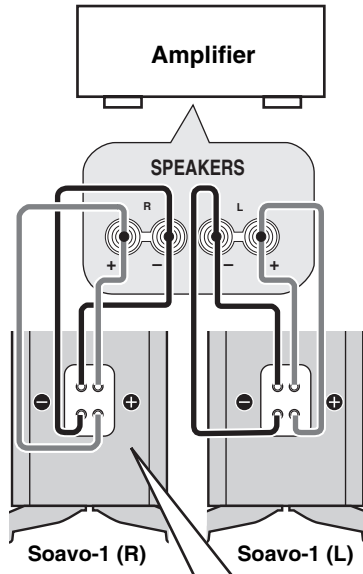

When your amplifier has two sets of speaker output terminals.

Both **SPEAKERS A** and **B** should be selected.

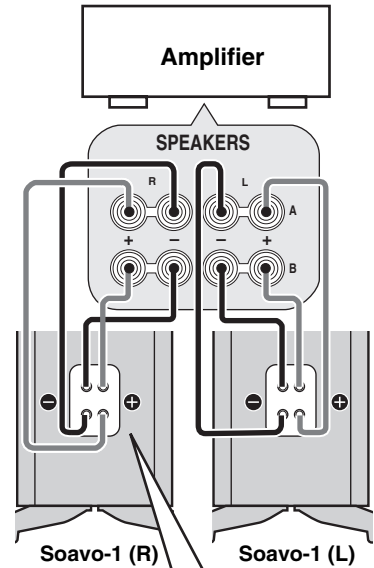

Remove the jumper cables before connecting.

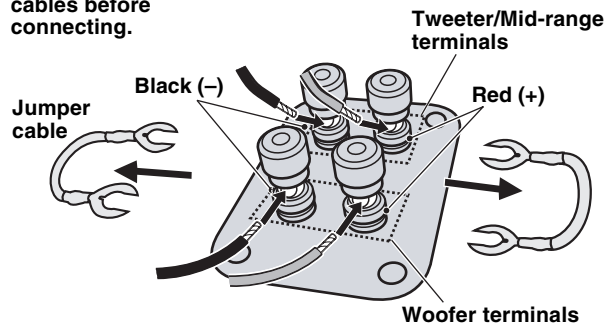

When using a banana plug

- 1 Unscrew the terminal knob.
- 2 Remove the cover by pulling it toward you.
- 3 Tighten the terminal knob.
- 4 Simply insert the banana plug into the terminal.

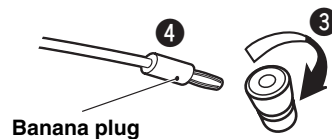
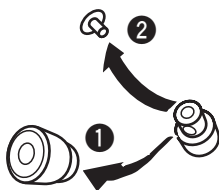

ATTACHING THE FRONT COVER

The speaker and the front cover are packed separately. To attach the front cover, line up the six salients (magnet) on the reverse side of the front cover with the six corresponding pegs.

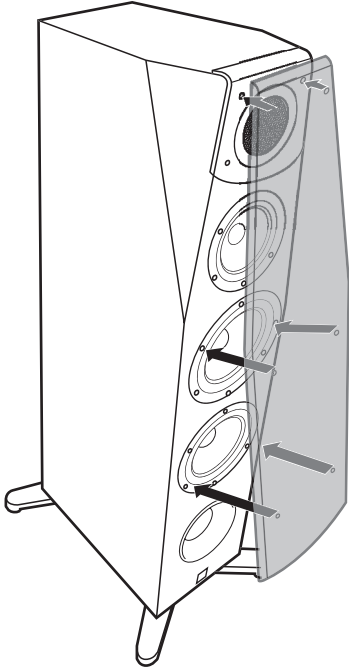

Notes

- When the cover is not attached, take care not to touch the speaker units with your hands or to exert excessive force with tools.
- There are magnets on the reverse side of the front cover. Do not place the front cover close to objects that might be affected by magnets, such as TVs, clocks, magnetic cards, diskettes etc. when you don't use it.

SPECIFICATIONS

Type	3-way 4-speaker bass reflex speaker system Magnetic shielding type
Driver	16 cm (6-1/2") cone woofer 13 cm (5") cone midrange 3 cm (1") aluminum dome tweeter
Impedance	6 Ω
Frequency Response	35 Hz to 50 kHz (-10 dB) to 100 kHz (-30 dB)
Nominal Input Power	50 W
Maximum Input Power	200 W
Sensitivity	89 dB/2.83 V/m
Crossover Frequency	500 Hz, 5 kHz
Dimensions (WxHxD)	349 x 1051 x 487 mm (13-11/16" x 41-3/8" x 19-3/16")
Weight	27 kg (59 lbs. 8 oz.)

- Specifications subject to change without notice due to product improvements.
- Care should be taken not to exceed the input power values noted above.

Taking care of the speaker

When you wipe this unit, do not use chemical solvents (ex. alcohol or thinners etc.); this might damage the finish. Use a clean, dry cloth. For heavy dirt, dampen a soft cloth in detergent diluted with the water, wring it out, and then clean this unit up with a soft cloth.



© 2006 YAMAHA CORPORATION All rights reserved.

YAMAHA ELECTRONICS CORPORATION, USA 6660 ORANGETHORPE AVE., BUENA PARK, CALIF. 90620, U.S.A.
YAMAHA CANADA MUSIC LTD. 135 MILNER AVE., SCARBOROUGH, ONTARIO M1S 3R1, CANADA
YAMAHA ELECTRONIK EUROPA G.m.b.H. SIEMENSSTR. 22-34, 25462 RELINGEN BEI HAMBURG, GERMANY
YAMAHA ELECTRONIQUE FRANCE S.A. RUE AMBROISE CROIZAT BP70 CROISSY-BEAUBOURG 77312 MARNE-LA-VALLEE CEDEX02, FRANCE
YAMAHA ELECTRONICS (UK) LTD. YAMAHA HOUSE, 200 RICKMANSWORTH ROAD WATFORD, HERTS WD18 7GQ, ENGLAND
YAMAHA SCANDINAVIA A.B. J A WETTERGRENS GATA 1, BOX 30053, 400 43 VÄSTRA FRÖLUNDA, SWEDEN
YAMAHA MUSIC AUSTRALIA PTY, LTD. 17-33 MARKET ST., SOUTH MELBOURNE, 3205 VIC., AUSTRALIA

YAMAHA CORPORATION

Printed in Indonesia  WH59840