

# YAMAHA AVC-30/U

*Natural Sound Stereo Amplifier*

*Amplificateur stéréo de la série "Natural Sound"*

*Natural Sound Stereoverstärker*

*Natural Sound stereoförstärkare*

*Amplificatore stereo dal suono naturale*



CENTER

## Die Deutsche Bundespost informiert

Sehr geehrter Rundfunkteilnehmer!

Dieses Gerät ist von der Deutschen Bundespost als Ton- bzw. Fernseh-Rundfunkempfänger zugelassen. Es entspricht den zur Zeit geltenden Technischen Vorschriften der Deutschen Bundespost und ist zum Nachweis dafür mit dem DBP-Zulassungszeichen ..... gekennzeichnet. Bitte überzeugen Sie sich selbst.

Dieses Gerät darf im Rahmen der umseitig abgedruckten "Allgemeinen Genehmigung für Ton- und Fernseh-Rundfunkempfänger" in der Bundesrepublik Deutschland betrieben werden. Beachten Sie aber bitte, daß aufgrund dieser Allgemeinen Genehmigung nur Sendungen des Rundfunks empfangen werden dürfen.\*) Wer unbefugt andere Sendungen (z.B. des Polizeifunks, des Seefunks, der öffentlichen beweglichen Landfunkdienste) empfängt, verstößt gegen die Genehmigungsaufgaben und macht sich daher nach § 15 Absatz 2 a des Gesetzes über Fernmeldeanlagen strafbar.

Die Kennzeichnung mit dem DBP-Zulassungszeichen bietet Ihnen die Gewähr, daß dieses Gerät keine anderen Fernmeldeanlagen einschließlich Funkanlagen stört. Die Zusatzbuchstaben S oder SK bei dem DBP-Zulassungszeichen besagen außerdem, daß das Gerät gegen störende Beeinflussungen durch andere Funkanlagen (z.B. des Amateurfunks, des CB-Funks) weitgehend unempfindlich ist. Sollten ausnahmsweise trotzdem Störungen auftreten, so wenden Sie sich bitte an die örtlich zuständige Funkstörungsmeßstelle.

\*) Zum Empfang anderer Sendungen darf dieses Gerät nur mit Genehmigung der Deutschen Bundespost benutzt werden. Allgemein genehmigt ist zur Zeit der Empfang der Aussendungen von Amateurfunkstellen und der Normalfrequenz- und Zeitzeichensendungen.

## Allgemeine Genehmigung für Ton- und Fernseh-Rundfunkempfänger

Die Allgemeine Ton- und Fernseh-Rundfunkgenehmigung vom 11. Dezember 1970 (veröffentlicht im Bundesanzeiger Nr. 234 vom 16. Dezember 1970) wird unter Bezug auf Abschnitt III der Genehmigung durch folgende Fassung der Allgemeinen Genehmigung für Ton- und Fernseh-Rundfunkempfänger gemäß den §§ 1 und 2 des Gesetzes über Fernmeldeanlagen ersetzt.

### Genehmigung für Ton- und Fernseh-Rundfunkempfänger

1. Die Errichtung und der Betrieb von Ton- und Fernseh-Rundfunkempfängern werden nach §§ 1 und 2 des Gesetzes über Fernmeldeanlagen in der Fassung der Bekanntmachung vom 17. 3. 77 (BGBl. I S. 459) allgemein genehmigt.

2. Ton- und Fernseh-Rundfunkempfänger im Sinne dieser Genehmigung sind Funkanlagen gemäß § 1 Abs. 1 des Gesetzes über Fernmeldeanlagen, die ausschließlich die für Rundfunkempfänger zugelassenen Frequenzabstimmbereiche\*) aufweisen und zum Aufnehmen und gleichzeitigen Hör- oder Sichtbarmachen von Ton- oder Fernseh-Rundfunksendungen bestimmt sind. Zum Empfänger gehören auch eingebaute oder mit ihm fest verbundene Antennen sowie bei Unterteilung in mehrere Geräte die funktionsmäßig zugehörigen Geräte.

Außer für den Empfänger von Rundfunksendungen dürfen Ton- und Fernseh-Rundfunkempfänger nur mit besonderer Genehmigung der Deutschen Bundespost für andere Fernmeldezwecke zusätzlich benutzt werden.

In den Empfänger eingebaute oder sonst mit ihm verbundene Zusatzgeräte (z.B. Ultraschallfernmeldeanlagen, Infrarotfernmeldeanlagen) werden von dieser Genehmigung nicht erfaßt (ausgenommen die Einrichtungen zum Empfang des Verkehrs Rundfunks). Desgleichen sind andere technische Empfängereigenschaften, die über den eigentlichen Zweck eines Rundfunkempfängers hinausgehen (z.B. zum Empfang anderer Funkdienste, für die Wiedergabe im Rahmen von Textübertragungsverfahren) hierdurch nicht genehmigt. Hierfür gelten besondere Regelungen.

### II.

Diese Genehmigung wird unter nachstehenden Auflagen erteilt.

1. Ton- und Fernseh-Rundfunkempfänger müssen den jeweils geltenden Technischen Vorschriften für Ton- und Fernseh-Rundfunkempfänger entsprechen. Eingebaute Zusatzgeräte müssen den für sie geltenden Bestimmungen und technischen Vorschriften genügen.

Änderungen der Technischen Vorschriften, die im Amtsblatt des Bundesministers für das Post- und Fernmeldewesen veröffentlicht werden, muß bei schon errichteten und in Betrieb genommenen Ton- und Fernseh-Rundfunkempfängern nachgekommen werden, wenn durch den Betrieb dieser Rundfunkempfänger andere elektrische Anlagen gestört werden.

Serienmäßig hergestellte Ton- und Fernseh-Rundfunkempfänger müssen zum Nachweis dafür, daß sie den technischen Vorschriften entsprechen, mit einer FTZ-Prüfnummer gekennzeichnet sein.\*\*) Die FTZ-Prüfnummer sagt über die elektrische und mechanische Sicherheit und die Einhaltung der Strahlenschutzbestimmungen nichts aus.

2. Ton- und Fernseh-Rundfunkempfänger dürfen an ortsfesten oder nichtortsfesten Rundfunk-Empfangsantennenanlagen, Verteilanlagen oder Kabelfernsehanlagen betrieben und im Rahmen der Bestimmungen über private Drahtfernmeldeanlagen mit Drahtfernmeldeanlagen verbunden werden.

Auf demselben Grundstück oder innerhalb eines Fahrzeuges dürfen Ton- und Fernseh-Rundfunkempfänger mit anderen Geräten oder sonstigen Gegenständen (z.B. Plattenspieler, Magnetaufzeichnungs- und -Wiedergabegeräten, Antennen) verbunden werden, sofern diese Geräte von der Deutschen Bundespost genehmigt sind oder keiner Genehmigung bedürfen.

Die räumliche Kombination von Funkanlagen mit Ton- oder Fernseh-Rundfunkempfängern ist nur dann zulässig, wenn die betreffenden Funkanlagen je für sich genehmigt sind.

3. Mit Ton- oder Fernseh-Rundfunkempfängern dürfen aufgrund dieser Genehmigung nur Sendungen des Rundfunks empfangen werden, also übertragene Tonsignale (Musik, Sprache) und Fernsignale (nur Bildinformationen). Andere Sendungen (z. B. des Polizeifunks, der öffentlichen beweglichen Landfunkdienste, Datenübertragungen) dürfen nicht aufgenommen werden; werden sie jedoch unbeabsichtigt empfangen, so dürfen sie weder aufgezeichnet noch anderen mitgeteilt noch für irgendwelche Zwecke ausgewertet werden. Das Vorhandensein solcher Sendungen darf auch nicht anderen zur Kenntnis gebracht werden.

4. Durch Ton- oder Fernseh-Rundfunkempfänger darf der Betrieb anderer elektrischer Anlagen nicht gestört werden.

5. Änderungen der Ton- oder Fernseh-Rundfunkempfänger, die die zulässigen Frequenzabstimmbereiche der Empfänger erweitern, gehen über den Umfang dieser Genehmigung hinaus und bedürfen vor ihrer Ausführung einer besonderen Genehmigung der Deutschen Bundespost.

Wer aufgrund dieser Genehmigung einen Ton- oder Fernseh-Rundfunkempfänger betreibt, hat bei einer Änderung der kennzeichnenden Merkmale von Ton- oder Fernseh-Rundfunksendern (insbesondere bei Änderung des Sendeverfahrens oder bei Frequenzwechsel) die ggf. notwendig werdenden Änderungen an dem Rundfunkempfänger auf seine Kosten vornehmen zu lassen.

6. Die Deutsche Bundespost ist berechtigt, Rundfunkempfänger und mit ihnen verbundene Geräte darauf zu prüfen, ob die Auflagen der Genehmigung und die Technischen Vorschriften eingehalten werden.

Den Beauftragten der Deutschen Bundespost ist das Betreten der Grundstücke oder Räume, in denen sich Ton- oder Fernseh-Rundfunkempfänger befinden, zu den verkehrsüblichen Zeiten zu gestatten. Befinden sich die Rundfunkempfänger oder mit ihnen verbundene Geräte nicht im Verfügungsbereich desjenigen, der die Empfänger betreibt, so hat er den Beauftragten der Deutschen Bundespost Zutritt zu diesen Teilen zu ermöglichen.

### III.

Bei Funkstörungen, die nicht durch Mängel der Rundfunkempfänger oder der mit ihnen verbundenen Geräte verursacht werden, können die Funkmelddienste der Deutschen Bundespost zur Feststellung der Störung in Anspruch genommen werden.

1. Diese Genehmigung kann allgemein oder durch die örtlich zuständige Oberpostdirektion einem einzelnen Betreiber gegenüber für einen bestimmten Rundfunkempfänger widerrufen werden. Ein Widerruf ist insbesondere zulässig, wenn die unter Abschnitt II aufgeführten Auflagen nicht erfüllt werden.

Anstatt die Genehmigung zu widerrufen, kann die Deutsche Bundespost anordnen, daß bei einem Verstoß gegen eine Auflage ein Ton- oder Fernseh-Rundfunkempfänger außer Betrieb zu setzen ist und erst bei Einhaltung der Auflagen wieder betrieben werden darf.

Die Auflagen dieser Genehmigung können jederzeit ergänzt oder geändert werden.

2. Diese Genehmigung ersetzt die Allgemeine Ton- und Fernseh-Rundfunkgenehmigung vom 11. Dezember 1970, sie gilt ab 1. Juli 1979.

Bonn, den 14. 5. 1979

Der Bundesminister für  
das Post- und Fernmeldewesen  
im Auftrag  
Haist

\*) Siehe Technische Vorschriften für Ton- und Fernseh-Rundfunkempfänger, veröffentlicht im Amtsblatt des Bundesministers für das Post- und Fernmeldewesen.

\*\*\*) Für ausnahmsweise noch nicht gekennzeichnete, vor dem 1. Juli 1979 errichtete und in Betrieb genommene Ton-Rundfunkempfänger wird die Kennzeichnung nicht verlangt.

**SUPPLIED ACCESSORIES  
ACCESSOIRES FOURNIS  
MITGELIEFERTES ZUBEHÖR  
MEDFÖLJANDE TILLBEHÖR  
ACCESSORI IN DOTAZIONE**

Remote Control Transmitter (RS-AVC30)  
Emetteur de télécommande (RS-AVC30)  
Fernbedienungsgeber (RS-AVC30)  
Fjärrkontroll-sändare (RS-AVC30)  
Trasmettitore del telecomando (RS-AVC30)

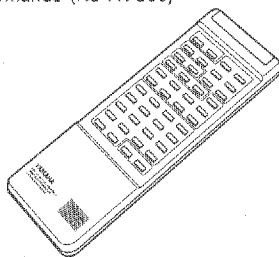

Remote Control Cable (5-pin, tuner)  
Câble de télécommande (5 broches, syntoniseur)  
Fernbedienungskabel (5-pol., Tuner)  
Fjärrkontroll-sladd (5-stift, tuner)  
Cavo di telecomando  
(a 5 piedini, sintonizzatore)

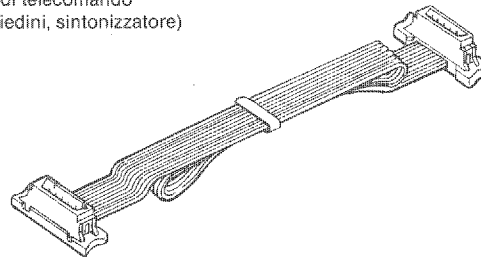

Remote Control Cable (mini-plug, turntable)  
Câble de télécommande (mini-prise, platine tourne-disque)  
Fernbedienungskabel (Ministecker, Plattenspieler)  
Fjärrkontroll-sladd (miniplugg, skivspelare)  
Cavo di telecomando (minispina audio, giradischi)

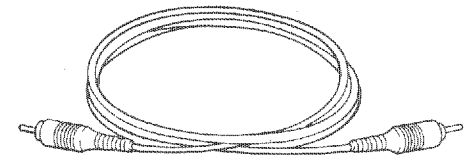

Batteries (size "AA", R06)  
Piles (Taille "AA", R06)  
Batterien (Größe "AA", R06)  
Batterier (storlek "AA", R06)  
Batterie (taglia "AA", R06)

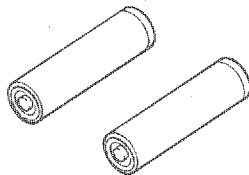

Remote Control Cable (6-pin, cassette deck)  
Câble de télécommande (6 broches, platine à cassette)  
Fernbedienungskabel (6-pol., Kassettendeck)  
Fjärrkontroll-sladd (6-stift, kassetband-spelardäck)  
Cavo di telecomando (a 6 piedini, registratore a cassette)

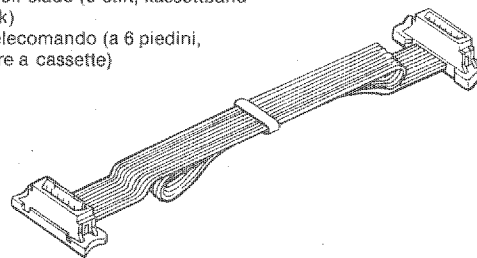

**2 FRONT PANEL**    **PANNEAU AVANT**    **FRONTPLATTE**  
**FRAMSIDA**    **PANNELLO ANTERIORE**

**6 REMOTE CONTROL TRANSMITTER**  
**EMETTEUR DE TELECOMMANDE**  
**FERNBEDIENUNGSGEBER**  
**FJÄRRKONTROLL-SÄNDARE**  
**TRANSMETTITORE DEL TELECOMANDO**

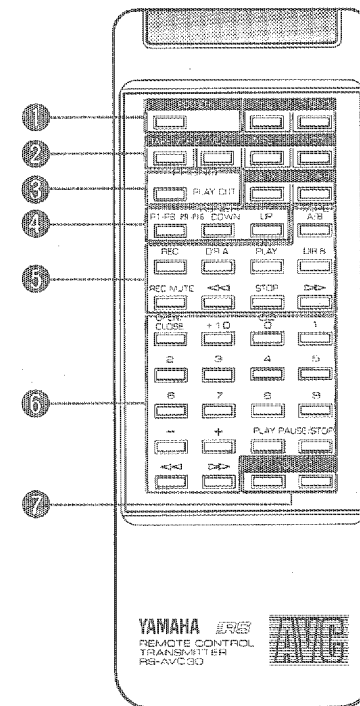
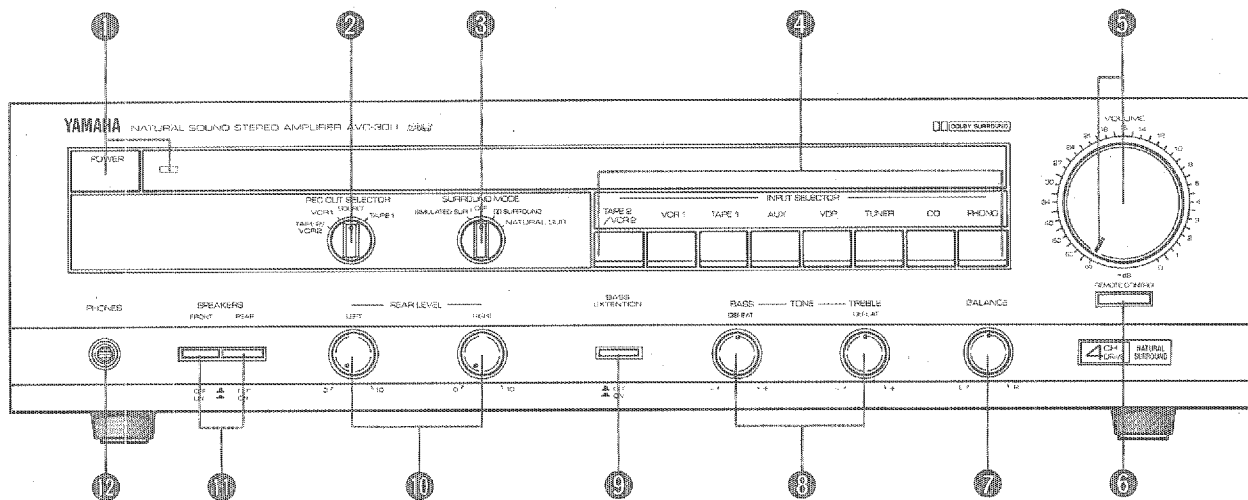

**REAR PANEL**    **PANNEAU ARRIERE**    **RÜCKPLATTE**  
**BAKSIDA**    **PANNELLO POSTERIORE**

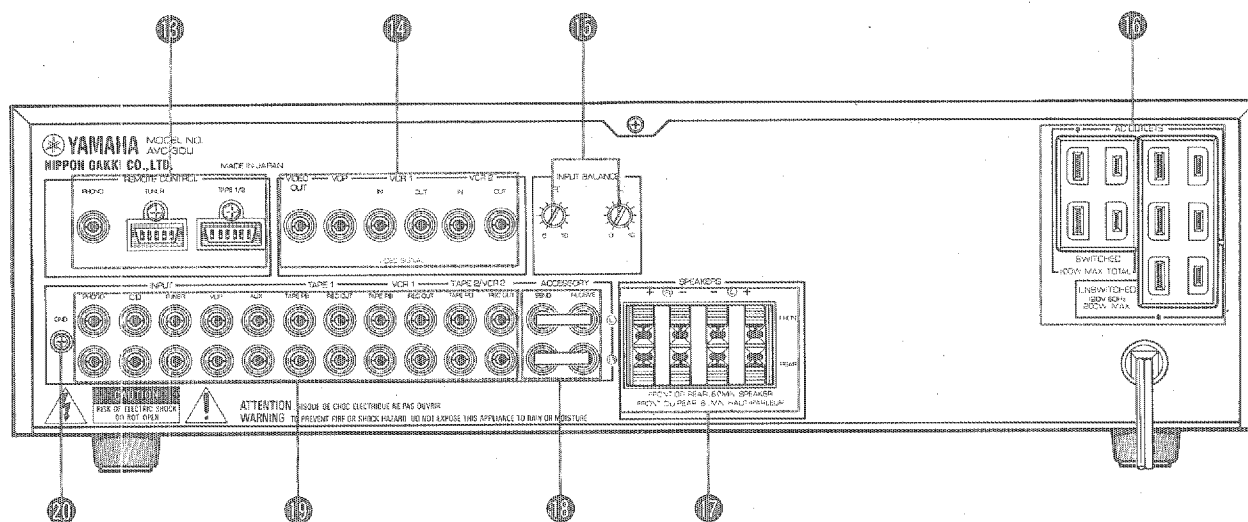

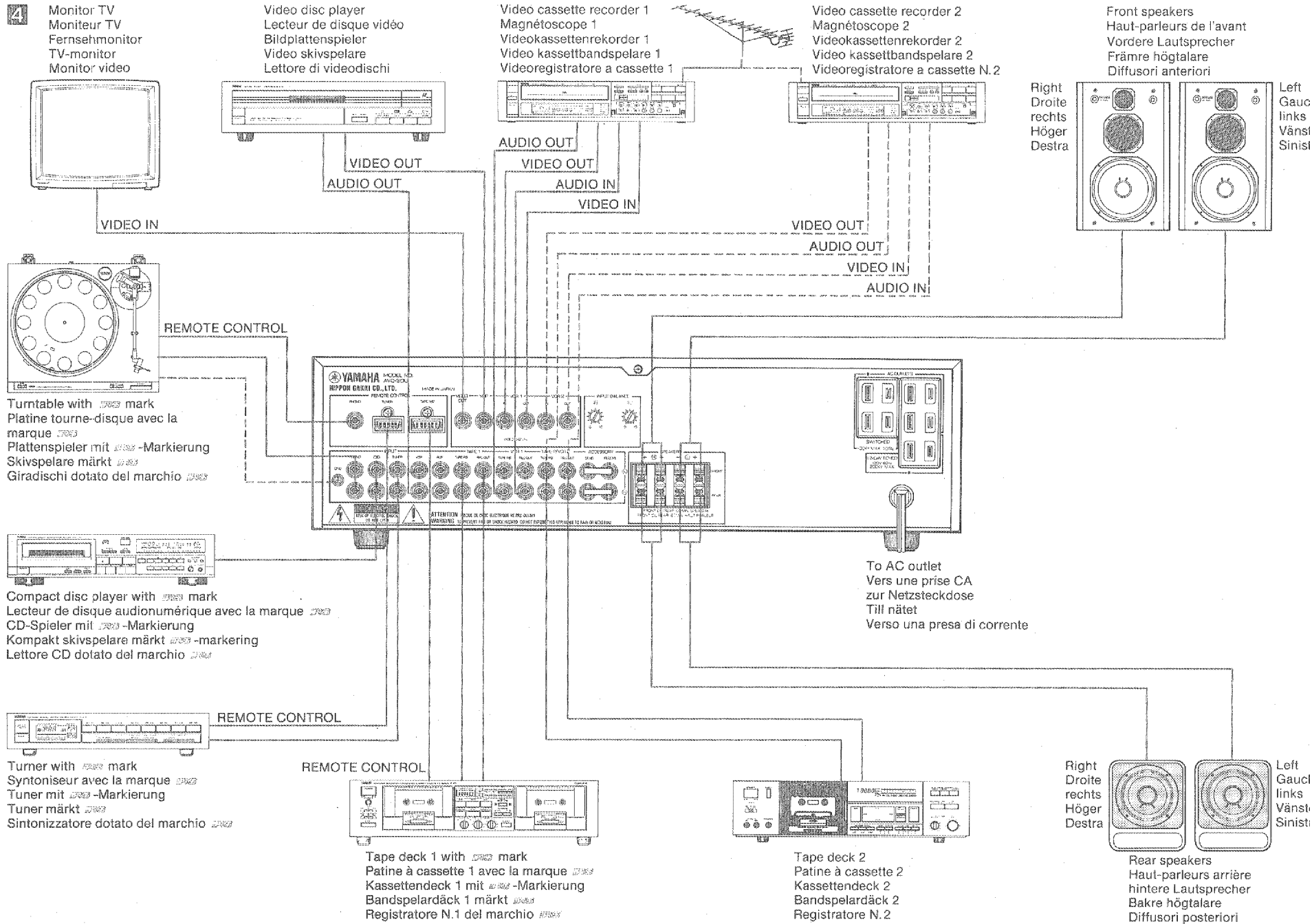

**5 REAR SPEAKER PLACEMENT**  
**EMPLACEMENT DES HAUT-PARLEURS ARRIERE**  
**AUFSTELLUNG DER HINTEREN LAUTSPRECHER**  
**UPPSTÄLLNING AV BAKRE HÖGTALARE**  
**POSIZIONE DEI DIFFUSORI POSTERIORE**

A

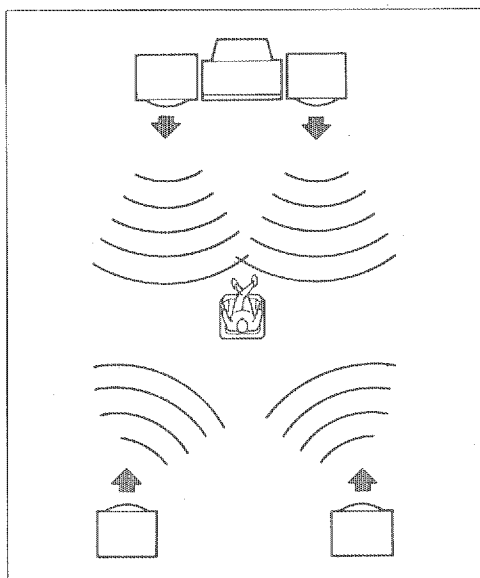

B

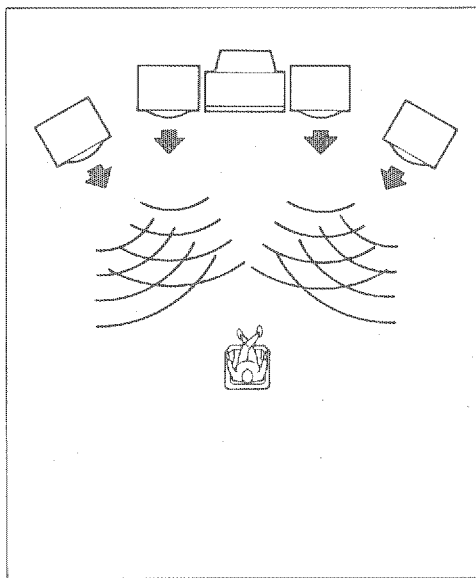

C

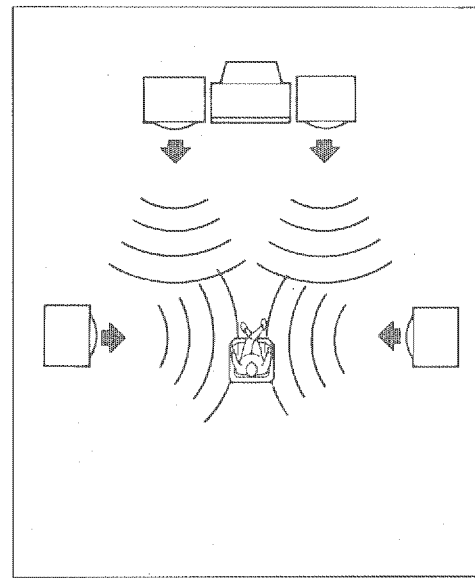



# ENGLISH

• Thank you for purchasing the YAMAHA AVC-30/U stereo amplifier.

## CAUTION: READ THIS BEFORE OPERATING YOUR AVC-30/U.

1. To ensure the finest performance, please read this manual carefully. Keep it in a safe place for future reference.
2. Install your unit in a cool, dry, clean place — away from windows, heat sources, and too much vibration, dust, moisture or cold. Avoid sources of hum (transformers, motors). To prevent fire or electrical shock, do not expose to rain and water.
3. Never open the cabinet. If a foreign object drops into the set, contact your dealer.
4. Do not use force on switches, knobs or cords. When moving the unit, first disconnect the power plug and the cords connecting the other equipment. Never pull the cord itself.
5. Always set the volume control to “-∞” while lowering the tonearm to play a record; turn the volume up with the stylus in the groove.
6. Do not attempt to clean the unit with chemical solvents; this might damage the finish. Use a clean, dry cloth.
7. Be sure to read the “Troubleshooting” section on common operating errors before concluding that your unit is faulty.
8. Grounding or polarization — The precautions should be taken so that the grounding or polarization of an appliance is not defeated.
9. Do not connect audio equipment to the AC outlet on the rear panel if that equipment requires more power than the outlets are rated to provide.
10. If your unit has a voltage selector (General model only), check that it is set to your local voltage before you plug it in. If not properly set, reset the switch to indicate your supply voltage.

### IMPORTANT

Please record the serial number of your unit in the space below.

Model: AVC-30/U  
Serial No.:

The serial number is located on the rear of the unit. Retain this Owner's Manual in a safe place for future reference.

### WARNING

TO PREVENT FIRE OR ELECTRICAL SHOCK, DO NOT EXPOSE THIS APPLIANCE TO RAIN OR MOISTURE.

### CAUTION

TO PREVENT ELECTRIC SHOCK DO NOT USE THIS (POLARIZED) PLUG WITH AN EXTENSION CORD RECEPTACLE OR OTHER OUTLET UNLESS THE BLADES CAN BE FULLY INSERTED TO PREVENT BLADE EXPOSURE.

## Special Instructions for U.K. Model

### IMPORTANT

The wires in the mains lead are coloured in accordance with the following code:

Blue: NEUTRAL  
Brown: LIVE

As the colours of the wires in the mains lead of this apparatus may not correspond with the coloured markings identifying the terminals in your plug, proceed as follows. The wire which is coloured BLUE must be connected to the terminal which is marked with the letter N or coloured BLACK. The wire which is coloured BROWN must be connected to the terminals which is marked with the letter L or coloured RED.

## SUPPLIED ACCESSORIES

(See Fig. 1.)

After unpacking, check that the following parts are contained.

- Remote control transmitter
- Batteries
- Remote control cable (5-pin)
- Remote control cable (6-pin)
- Remote control cable (mini-plug)

## CONTROL PARTS AND THEIR FUNCTIONS

(See Fig. 2.)

### FRONT PANEL

#### POWER switch

Press this switch to turn the power on. Press the switch again to turn the power off.

#### Power indicator (Canada, Australia and General models)

When the power is supplied, the indicator lights.

#### Standby indicator (Europe and U.K. models)

When the unit is connected to an AC outlet, this indicator lights. Press the POWER switch of the unit or POWER of the remote control transmitter to operate the unit.

#### REC OUT SELECTOR

Used to select the program source to be recorded.



### ③ SURROUND MODE selector

Used to select the surround mode according to the source played.

#### **SIMULATED SURROUND**

Natural surround effects can be given to monaural sources. While the front speakers reproduce ordinary monaural sound, the rear speakers reproduce the sound which has been distributed to the left and right speakers by the comb filter.

#### **OFF**

Set to this position when listening to the normal 2-channel stereo sound without reverberation effect. The rear speaker signals are not output.

#### **□□ DOLBY SURROUND**

Set to this position when playing the program source having a "□□ DOLBY SURROUND" marking.

#### **□□ DOLBY SURROUND**

\* Manufactured under license from Dolby Laboratories Licensing Corporation. Additionally license under one or more of the following patents: U.S. numbers 3,632,886, 3,746,792 and 3,959,590; Canadian numbers 1,004,603 and 1,037,887. "Dolby" and the Double-D symbol are trademarks of Dolby Laboratories Licensing Corporation.

#### **NATURAL SURROUND**

Natural surround effects can be reproduced from ordinary stereo sources, using YAMAHA's original surround processor circuit.

\* No sound is output from the rear speakers when the played source is monaural.

### ④ INPUT selectors and indicators

Used to select the audio or video source to be heard.

### ⑤ VOLUME control and indicator

This control is used to raise or lower the output volume level. It acts as a master volume control, increasing or decreasing the signal level to both front and rear speaker pairs. The built-in indicator lights when the POWER switch is set to ON.

### ⑥ REMOTE CONTROL sensor

This is used to receive signals from the remote control transmitter.

### ⑦ BALANCE control

Use this control to concurrently change the left and right output volume to the speaker terminals.

### ⑧ TONE controls

#### **BASS**

Used to increase or decrease the low frequency response. The DEFEAT position produces flat response.

#### **TREBLE**

Used to increase or decrease the high frequency response. The DEFEAT position produces flat response.

### ⑨ BASS EXTENSION switch

Used to activate a circuit which effectively extends the low frequency output of the amplifier.

### ⑩ REAR LEVEL controls

These controls raise or lower the volume at REAR SPEAKERS terminals.

### ⑪ FRONT/REAR SPEAKERS selectors

Set these selectors to select the speakers to be driven.

### ⑫ PHONES jack

Plugging in the headphones mutes the sound from the front speakers. To shut off the sound from the rear speakers, set the SURROUND MODE selector to OFF.

## ■ REAR PANEL

### ⑬ REMOTE CONTROL connectors

Use these to connect compatible YAMAHA components with an *RS* mark to your amplifier for remote control of each component.

#### **PHONO**

Connect to a turntable using the cable with a mini-plug connectors.

#### **TUNER**

Connect to a tuner using the cable with a 5-pin connector.

#### **TAPE**

Connect to a cassette deck using the cable with 6-pin connector.

### ⑭ Video signal jacks

Use these to connect the video signal cords from your components to the amplifier. They should be connected to the proper input/output jacks for each unit.

#### **VIDEO OUT**

Connect this to the video in jack on a video monitor or antenna terminal on a TV.\*

#### **VDP**

Connect a video disc player.

#### **VCR 1**

Connect a first video recorder for both recording and playback.

#### **VCR 2**

Connect a second video recorder for both recording and playback.

### ⑮ INPUT BALANCE controls

Used to obtain the best surround condition. Disconnect the front speakers and adjust these controls so that the center sound image of the rear speakers is minimum. For normal operation, set these controls to MAX position.

### ⑯ AC OUTLETS

Use these to connect the power cords from your components to the amplifier.

The power to the SWITCHED outlets is controlled by the amplifier's POWER switch. They will supply power to any component whenever this unit is turned on, whether by the front panel POWER switch.

The power to the UNSWITCHED (General, U.S.A. and Canada models) outlet is not controlled by the amplifier. It will continually supply power to any unit connected.

The maximum power (total power consumption of components) that can be connected to the SWITCHED AC OUTLETS is 100 watts (General model: 150 watts) and to the UNSWITCHED AC OUTLET is 200 watts.

Note that the AC outlets are size-coded for polarity, so insert plugs correctly.

### ⑰ FRONT and REAR SPEAKERS terminals

Connect front and rear speakers to these terminals. See the Connections section of this manual for details on speaker connections.

### ⑪ ACCESSORY jacks

Use these jacks to connect an optional graphic equalizer, sound processor, etc. For normal operation, keep the pins connected.

### ⑫ Audio signal connection jacks

Use these to connect the audio signal cords from your components to the amplifier. They should be connected to the proper input/output jacks for each unit. Be sure that L and R channels are connected consistently.

#### TAPE 2/VCR 2

Connect a second cassette deck or audio signal of the video cassette recorder for both recording and playback.

#### VCR 1

Connect a video cassette recorder for both recording and playback.

#### TAPE 1

Connect a first cassette deck for both recording and playback.

#### AUX

Connect another audio component. A turntable cannot be connected to these jacks.

#### VDP

Connect an audio signal of the video disc player.

#### TUNER

Connect a tuner.

#### CD

Connect a compact disc player.

#### PHONO

Connect a turntable.

### ⑬ GND terminal

Connect the ground wire of a turntable.

## ■ REMOTE CONTROL TRANSMITTER

(See Fig. ⑬.)

### ① POWER switch

Press this key to turn the power of amplifier ON and OFF.

### ② INPUT selector keys

Select the desired programs source with these keys.

### ③ Turntable section

This key is used to start and stop record play on the turntable with *RS* mark connected to this unit. This key functions same as the PLAY/CUT key on the turntable. Pressing this key starts record play and pressing it again stops playing.

### ④ Tuner section

These keys are used to select the broadcast station preset on the tuner with *RS* mark connected to this unit.

#### UP

Press to select the broadcast station preset on the tuner. Each time this key is pressed, the preset number is increased by one. (Ex: P7 → P8) When the key is pressed during the P8 (P16) station is received, the preset number will be changed to P1 (P9).

#### DOWN

Press to select the broadcast station preset on the tuner. Each time this key is pressed, the preset number is decreased by one. (Ex: P8 → P7) When the key is pressed during the P1 (P9) station is received, the preset number will be changed to P8 (P16).

#### P1-8/9-16

Each time this key is pressed, the preset station range is changed between P1-8 and P9-16 alternately.

### ⑤ Tape deck section

These keys are used to operate the cassette deck with *RS* mark connected to this unit.

#### A/B

Press to select the deck to be operated between the deck A and B on the double cassette deck.

#### DIR A

Press to change the tape running direction of the deck A on the double cassette deck.

### PLAY

Press to start tape play. When the double cassette deck used, pressing the key starts tape play on the last playing deck.

### DIR B

Press to change the tape running direction of the deck B on the double cassette deck.

### REC

Press to start recording.

### REC MUTE

Press to make the non-recorded section during recording



Press to fast forward the tape.

### STOP

Press to stop the tape.



Press to rewind the tape.

### ⑥ CD player section

The CD player with *RS* mark connected to this unit can be controlled directly with the remote control transmitter.

#### 0-9

Used to select the tune directly.

#### +10

Used to select the tune directly. For 11th tune, press +10 and 1.

### OPEN/CLOSE

Press to open or close the disc tray.

### PAUSE/STOP

Used to set the player to pause or stop mode. Pressing it key once to stop play temporarily and pressing it again stops play.

### PLAY

Press this key to start play.



Press to advance to the beginning of the next tune.



Press to return to the beginning of the current tune. When this key is pressed at the beginning of the tune, the play will start at the beginning of the previous tune.



Press to fast forward the tune.



Press to fast forward the tune.

### ⑦ VOLUME control keys

These keys are used to adjust the volume level heard from

## USING THE REMOTE CONTROL TRANSMITTER

The remote control transmitter supplied with your amplifier is designed to control all the most commonly used features of the amplifier. If the CD player, tuner, turntable and cassette deck connected to your amplifier are YAMAHA components designed for remote control compatibility (components with an *ERS* mark), then this remote control transmitter will also control various functions of each component. Please consult your YAMAHA dealer for information on which components are compatible with the remote control transmitter. Note that this Remote Control will directly operate any compatible YAMAHA CD player.

## BATTERY INSTALLATION

The remote control unit uses 2 batteries (size "AA", R06). Install them according to the following illustration. Be sure that they are installed correctly.

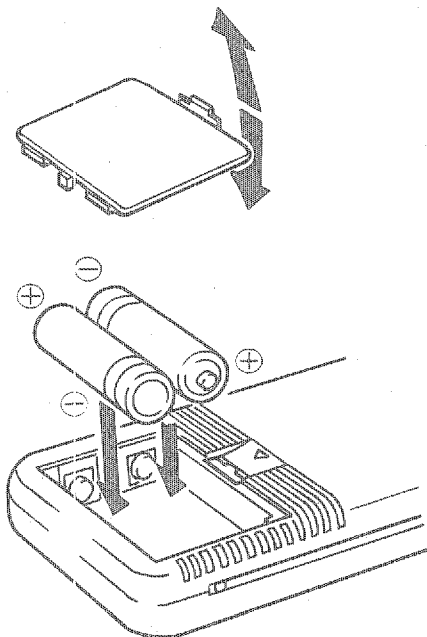

## OPERATION RANGE

You must point the remote control unit toward the amplifier and be within about 7 meters (23 feet) of it for proper operation.

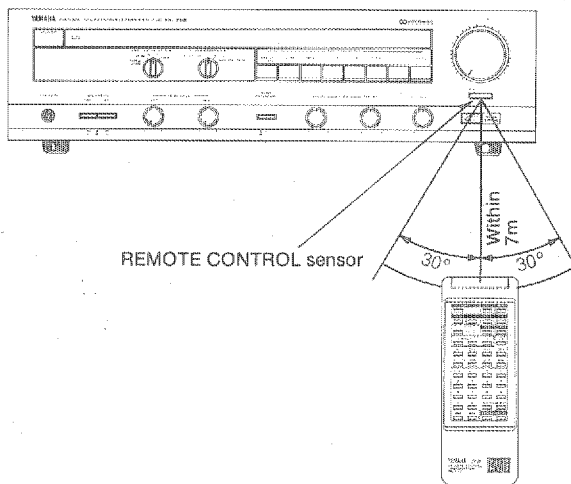

## CONNECTIONS

(See Fig. 4.)

## NOTES ON CONNECTIONS

- Be sure to turn off the power to all units before making any connections.
- The power cord and AC outlet have polarity indicators — a minus sign with the cord and sockets of a different size with the AC outlet. The purpose of this is to match polarities. Observe the polarity marks when connecting the AC outlets of amplifier and other equipment.

## POWER CORDS

Connect the power cord of your amplifier to an AC outlet.

## SPEAKERS

Connect the SPEAKERS terminals to your front and rear speakers with the proper gauge of wire, cut to be as short as possible. Press the speaker wire terminal tabs down, then insert the bare wires and secure them by releasing the tabs. If these connections are faulty, no sound will be heard from the speakers. Make sure that the polarity of the speaker wires is correct, that is, that the + and - markings are observed. If these wires are reversed, the sound will be unnatural and will lack bass. Do not coil up excess speaker wire or bundle the speaker wires with the power cords.

## TURNTABLE

Connect the output cords of the turntable to the PHONO jacks, and connect the ground cord to the GND terminal. This should produce minimum hum, but in some cases better results are obtained with this cord disconnected.

## ■ COMPACT DISC PLAYER

Connect the output jacks of the compact disc player to the CD jacks.

## ■ TUNER

Connect the output jacks of the tuner to the TUNER jacks.

## ■ VIDEO DISC PLAYER

Connect the video output jack from a video disc player to the VDP jack.

Connect the audio output jacks from a video disc player to the VDP jacks.

## ■ OTHER AUDIO COMPONENTS

Connect the output jacks of another audio source to the AUX jacks. A turntable cannot be connected to the AUX jacks.

## ■ TAPE DECK 1

Connect the cords from a cassette deck to the TAPE 1 jacks. The playback (LINE OUT) jacks go to the TAPE PB jacks, and the record (LINE IN) jacks go to the REC OUT jacks.

## ■ VCR 1

Connect the video jacks of a video cassette recorder to the VCR 1 jacks. The playback (VIDEO OUT) jack of the VCR goes to the TAPE PB jack, and the record (VIDEO IN) jack goes to the REC OUT jack.

Connect the audio output jacks of a video cassette recorder to the VCR 1 jacks. The playback (AUDIO LINE OUT) jacks of the VCR go to the TAPE PB jacks, and the record (AUDIO LINE IN) jacks go to the REC OUT jacks.

## ■ TAPE DECK 2/VCR 2

Connect the audio jacks of a second cassette recorder or video cassette recorder to the TAPE 2/VCR 2 jacks in the same way.

Connect the video jacks of a second video cassette recorder to the VCR 2 jacks in the same way.

## ■ MONITOR TV

Connect the video jack from a monitor to the VIDEO OUT jack.

Note that the audio connections to the monitor are not necessary as the audio portion of the signal is sent to your speakers through the amplifier.

## ■ OTHER COMPONENTS

To connect a graphic equalizer, sound processor, etc., remove the pins from the ACCESSORY jacks as shown below.

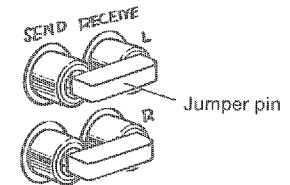

Connect the input jacks of the audio component to the SEND jacks and output jacks to the RECEIVE jacks with correct right and left polarities.

## ■ REMOTE CONTROL CABLE

The REMOTE CONTROL connectors are used when you have YAMAHA compatible components with an **ERS** mark.

These connections allow you to control the components from the supplied remote control transmitter.

Connect the remote control cables from the component to the correct connectors on your amplifier (i.e. PHONO TUNER, TAPE).

Note that no cable is necessary for a compatible CD player as the remote control transmitter operates the player directly.

## OPERATIONS

### ■ TO PLAY PROGRAM SOURCE

1. Press the POWER switch.
2. Select the program source to be heard with the INPUT SELECTOR.
3. Play the program source.
4. Adjust the VOLUME and TONE controls.

For details of the surround mode, refer to "USING THE SURROUND PROCESSOR" on page 13.

### ■ TO RECORD PROGRAM SOURCE

1. Press the POWER switch.
2. Select the program source to be recorded with the REC OUT SELECTOR.
3. Play the program source to be recorded and set the tape deck or video cassette recorder to record mode.

The settings of the SURROUND MODE selector, TONE controls, VOLUME control and BASS EXTENSION switch do not affect the recording.

### ■ TO DUB AUDIO TAPES

1. Press the POWER switch.
2. Set the REC OUT SELECTOR to select the program source to be dubbed.
3. Set the tape decks or video cassette recorders to play and record mode respectively.
4. To listen to other program source during dubbing, select the program source to be listened to with the INPUT SELECTOR.

The settings of the SURROUND MODE selector, TONE controls, VOLUME control and BASS EXTENSION switch do not affect the dubbing.

### ■ TO RECORD VIDEO SOURCES

1. Select the desired program source to be recorded with the REC OUT SELECTOR.  
It is possible to record the video source from the video equipment and the audio source from the another audio equipment together.  
In this case, set the REC OUT SELECTOR to the SOURCE position and select the desired video and audio sources with the INPUT SELECTOR.
2. Set the VCR for recording to the record-pause mode.
3. Play the video source to be recorded and start recording with the recording VCR at the same time.

### ■ TO DUB VIDEO TAPES



1. Press the POWER switch.
2. Set the REC OUT SELECTOR to select the program source to be dubbed.
3. Set the video cassette recorders to play and record mode respectively.
4. To listen to other program source during dubbing, select the program source to be listened to with the INPUT SELECTOR.

The settings of the SURROUND MODE selector, TONE controls, VOLUME control and BASS EXTENSION switch do not affect the dubbing.

## ■ USING THE SURROUND PROCESSOR

This unit incorporates a sophisticated, multi-mode surround processing circuitry which allows you to expand the audio sound field for a theater-like experience in the listening/viewing room.

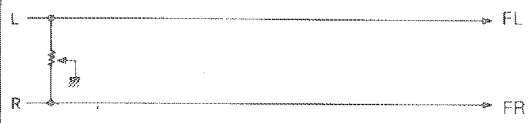
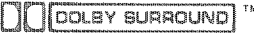
● The surround processor in this unit is effective only when the unit is used in a 4-speaker system setup.

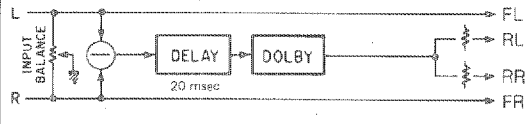
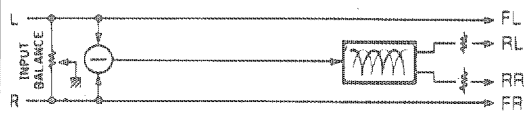
|                       | Source   | Position   | Signal processing routes  | Rear speaker output   |
|-----------------------|--|--|---|---|
| <b>Mono sources</b>   | Video/Sound<br>Sports programs   | SIMULATED<br>SURROUND  |   | A comb filter distributes each band to right and left.  |
| <b>All sources</b>    |  | OFF  |   | The rear speaker signals are not output.  |
| <b>Stereo sources</b> |  <b>DOLBY SURROUND™</b><br>For video programs with<br>the Dolby |  SURROUND |   | Dolby surround decoder reverberation components are delayed, and output via the rear, left and right speakers.  |
|                       | Video/Sound<br>Sports programs   | NATURAL<br>SURROUND  |  | Reverberation components are divided between the rear, left and right speakers by a comb filter. This results in a naturally expansive sound with a broad band. |

When replaying mono sources in the  SURROUND or NATURAL SURROUND positions, no sound is heard from the rear speakers.

FL: Front left speaker output  
FR: Front right speaker output  
PL: Rear left speaker output  
PR: Rear right speaker output

## ■ REAR SPEAKER PLACEMENT

(See Fig. 5.)

The placement of a rear speaker pair in the listening room will greatly affect the overall sound field created. A small pair of speakers is all that is really required to create the full effect, and the most basic speaker placement configuration is the one shown in Fig. A. This setup is ideal for creating a theaterlike atmosphere for movies and other video programs.

The "B" setup creates a sound field with added depth, much like that experienced in a live concert hall, where all the sound is coming at you from the front. It is most appropriate for musical sources, rather than videos.

The "C" speaker placement configuration effectively "widens" the sound field, and is suitable for movies and other video programs.

While the most basic speaker placement setup is recommended at first, by experimenting with different speaker placements for each musical or video source, and with each surround mode, you will be able to create a wide variety of sound field effects suited to your listening environment, and to your own particular tastes.

## ■ □□ (Dolby) SURROUND

With a great number of movies made today, the sound track is specially encoded with the Dolby surround mode for playback in movie theaters equipped with Dolby surround processing sound systems. This is responsible for the incredibly lifelike effect you experience at movie theaters: while dialogue comes at you from the front speakers, sound effects, background noise, and other ambient noise in the sound track comes at you from behind as well. You are literally surrounded in sound.

Dolby surround is encoded on the sound track of commercially available video cassettes and video discs as well. When you play tapes encoded with Dolby surround on your home video system, the Dolby surround mode on this unit decodes the signal and feeds the sound effects, background noise, ambient noise, etc. through your rear speakers so the same surround effect experienced in the theater is experienced in your living room as well. The Dolby surround mode will have no effect on video sources not encoded with Dolby surround.

## ■ SIMULATED SURROUND

The Simulated Surround mode is also intended for monaural audio sources, such as video and TV programs, it creates a surround sound effect, and employs a comb filter for an extra dimension of depth and imaging.

## ■ NATURAL SURROUND

The Natural Surround is an exclusive YAMAHA surround processing mode which is effective with all music and audio sources of video sound. It creates a natural, lifelike surround effect without the use of delay circuitry, adding considerable depth and imaging to all audio sources. It is recommended for both music listening and for viewing stereo video sources.

### NOTE

If a monaural sound source is used in the Natural Surround mode, no sound will be heard from the rear speakers.

## ■ OFF

When the selector is set to OFF, no surround processing is in effect.

## ■ OPERATION

1. Play the program source.
2. Select the surround mode with the SURROUND MODE selector.
3. Adjust the REAR LEVEL controls.
4. Use the VOLUME control to adjust the whole sound level.



## SPECIFICATIONS

### ■ AUDIO SECTION

|   |   |
|---|---|
| <b>Minimum RMS Output Power per Channel</b>       |   |
| 8 ohms, FRONT 20 Hz to 20 kHz,<br>0.05% THD ..... | 100W<br>(Except Europe model)                   |
|   | 80W<br>(Europe model)                           |
| 8 ohms, REAR 1 kHz, 0.5% THD .....                | 20W<br>(SIMULATED SURROUND or NATURAL SURROUND) |
| <b>Damping Factor</b>                             |   |
| (8 ohms, 1 kHz) .....                             | 50  |
| <b>Input Sensitivity/Impedance</b>                |   |
| PHONO MM .....                                    | 2.5 mV/47 k-ohms                                |
| VIDEO .....                                       | 1Vp-p/75 ohms                                   |
| CD/TAPE/TUNER/AUX/VDP/VCR/<br>ACCESSORY .....     | 150 mV/47 k-ohms                                |
| <b>Maximum Input Level (1 kHz, 0.01% THD)</b>     |   |
| PHONO MM .....                                    | 130 mV  |
| <b>Output Level/Impedance</b>                     |   |
| REC OUT .....                                     | 150 mV/470 ohms                                 |
| VIDEO .....                                       | 1Vp-p/75 ohms                                   |
| <b>Headphone Jack Rated Output/Impedance</b>      |   |
| 8 ohms, 0.05% THD .....                           | 0.8V/270 ohms                                   |
| <b>Frequency Response (20 Hz to 20 kHz)</b>       |   |
| CD/TAPE/TUNER/AUX/VDP/VCR/<br>ACCESSORY .....     | 0±0.5 dB  |
| <b>RIAA Equalization Deviation</b>                |   |
| PHONO MM .....                                    | ±0.5 dB   |

|  |                 |
|--|-----------------|
| <b>Total Harmonic Distortion (20 Hz to 20 kHz)</b>                       |                 |
| PHONO MM (3V) .....  | 0.008%          |
| CD/TAPE/TUNER to SP OUT<br>(50W/8 ohms) .....                            | 0.05%           |
| <b>Signal to Noise Ratio (IHF-A Network)</b>                             |                 |
| PHONO MM (5 mV Input Shorted) .....                                      | 80 dB           |
| CD/TAPE/TUNER/AUX/VDP/VCR/ACCESSORY<br>(Shorted) .....                   | 100 dB          |
| <b>Residual Noise</b>  |                 |
| (IHF-A Network) .....  | 150 µV          |
| <b>Channel Separation (1 kHz, Vol. —30 dB)</b>                           |                 |
| PHONO MM Input Shorted .....   | 60 dB           |
| CD/TAPE/TUNER/AUX/VDP/VCR/ACCESSORY<br>Input 5.1 k-ohms Terminated ..... | 60 dB           |
| <b>Tone Control Characteristics</b>                                      |                 |
| <b>BASS</b>  |                 |
| boost/cut .....  | ±10 dB (50 Hz)  |
| turnover frequency .....   | 350 Hz          |
| <b>TREBLE</b>  |                 |
| boost/cut .....  | ±10 dB (20 kHz) |
| turnover frequency .....   | 3.5 kHz         |
| <b>BASS EXTENTION</b> .....  | 75 Hz + 7 dB    |

### ■ GENERAL

|                                     |  |
|-------------------------------------|--|
| <b>Power Supply</b>                 |  |
| Europe Model .....                  | 220V, 50   |
| General Model .....                 | 110/120/220/240V, 50/60  |
| U.K. and Australia Models .....     | 240V, 50   |
| Canada Model .....                  | 120V, 60   |
| <b>Power Consumption</b>            |  |
| Europe Model .....                  | 38   |
| General Model .....                 | 26   |
| U.K. and Australia Models .....     | 26   |
| Canada Model .....                  | 420W (550 W)   |
| <b>AC Outlets</b>                   |  |
| Switched x 4 .....                  | 150W max. (To<br>(General model<br>100W max. (To<br>(Canada, Europe, U.K. and Australia mode |
| Unswitched x 1 .....                | 200W m<br>(General and Canada mode   |
| <b>Dimensions (W x H x D)</b> ..... | 435 x 121 x 315.5 r<br>(17-1/8" x 4-3/4" x 12-7/1  |
| <b>Weight</b> .....                 | 10.2 kg (22 lbs. 8 oz)   |
| <b>Accessories</b> .....            |  |
|                                     | Remote control cable (mini-plug)   |
|                                     | Remote control cable (5-pin)   |
|                                     | Remote control cable (6-pin)   |
|                                     | Remote control transmitter (RS-AVC30)  |
|                                     | Battery (size "AA", R06)   |

Specifications subject to change without notice.

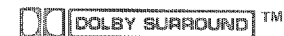

Manufactured under license from Dolby Laboratories Licensing Corporation. Additionally licensed under one or more of the following patents: U.S. numbers 3,632,886, 3,746,792, and 3,959,590; Canada numbers 1,004,603 and 1,037,877. "Dolby" and the double-D symbol are trademarks of Dolby Laboratories Licensing Corporation.

## TROUBLESHOOTING

If the unit fails to operate normally, check the following points to determine whether the fault can be corrected by the simple measures suggested. If it cannot be corrected, or if the fault is not listed in the SYMPTOM column, disconnect the power cord and contact your dealer or service center for help.

| SYMPTOM   | CAUSE  | REMEDY  |
|---|--|---|
| <b>The amplifier fails to turn on when the POWER switch is pressed.</b> | <ul style="list-style-type: none"> <li>● Power cord is not plugged in or is not completely inserted.</li> </ul>  | <ul style="list-style-type: none"> <li>● Firmly plug in the power cord.</li> </ul>  |
| <b>No sound.</b>  | <ul style="list-style-type: none"> <li>● Incorrect output cord connections.</li> </ul>   | <ul style="list-style-type: none"> <li>● Connect cord properly. If the problem persists, the cords may be defective.</li> </ul>                             |
|   | <ul style="list-style-type: none"> <li>● Incorrect amplifier operation.</li> </ul>   | <ul style="list-style-type: none"> <li>● Set the amplifier controls to the correct input selection.</li> </ul>  |
| <b>Sound "hums".</b>  | <ul style="list-style-type: none"> <li>● Incorrect cord connections.</li> </ul>  | <ul style="list-style-type: none"> <li>● Firmly connect the audio plugs. If the problem persists, the cord may be defective.</li> </ul>                     |
| <b>No picture.</b>  | <ul style="list-style-type: none"> <li>● Incorrect cord connections.</li> <li>● Video unit not turned on.</li> <li>● Wrong video unit selected.</li> </ul> | <ul style="list-style-type: none"> <li>● Connect the video plugs correctly.</li> <li>● Turn video unit on.</li> <li>● Select correct video unit.</li> </ul> |

SINCE 1887



**YAMAHA**

NIPPON GAKKI CO., LTD. HAMAMATSU, JAPAN