



MUSIC SYNTHESIZER

MONTAGE 6

MONTAGE 7

MONTAGE 8

Data List

Contents

Performance List	2
Performance Category List	21
Drum Kit Assign List	22
Waveform List	65
Live Set List	85
Arpeggio Type List	88
Effect Type List	147
Effect Parameter List	149
Effect Preset List	161
Effect Data Assign Table	164
Control List	178
Algorithm Chart	182
MIDI Data Format	186
MIDI Data Table	190
MIDI Implementation Chart	221

Performance List

*1 The new Performances added by firmware version 2.50 update.

No.	Performance Name	Main Category	Sub Category
1	CFX + FM EP	Piano	Acoustic
2	CFX + FM EP 2	Piano	Acoustic
3	CFX Concert	Piano	Acoustic
4	CFX Stage	Piano	Acoustic
5	CFX Pop/Rock	Piano	Acoustic
6	CFX PopStudioGrand	Piano	Acoustic
7	CFX Moody	Piano	Acoustic
8	CFX & Pad	Piano	Acoustic
9	CFX & Pad 2	Piano	Acoustic
10	CFX & Orch	Piano	Acoustic
11	CFX & Orch 2	Piano	Acoustic
12	CFX Shrine	Piano	Acoustic
13	CFX Shrine 2	Piano	Acoustic
14	CFX Padded	Piano	Acoustic
15	CFX Padded 2	Piano	Acoustic
16	CFX & Pad & Sub	Piano	Acoustic
17	Sky Keys	Piano	Acoustic
18	Lonely Keys	Piano	Acoustic
19	S700 for Montage	Piano	Acoustic
20	Upright Piano	Piano	Acoustic
21	Upright Mod 1	Piano	Acoustic
22	Upright Mod 2	Piano	Acoustic
23	Upright Tack Piano	Piano	Acoustic
24	Upright Atmos	Piano	Acoustic
25	Imaginary Upright	Piano	Acoustic
26	Cold Upright	Piano	Acoustic
27	Acoustic Piano DA	Piano	Modern
28	AcPiano+FM Piano DA	Piano	Modern
29	AcPf+FM Pf+Pad DA	Piano	Modern
30	Full AP/EP/Pd/Str	Piano	Acoustic
31	Full AP/FMEP/Pd/St	Piano	Acoustic
32	FM EP & CFX Grand	Piano	Acoustic
33	FM EP & CFX Grand 2	Piano	Acoustic
34	Schlager Weapon 1	Piano	Modern
35	The New Ballad	Piano	Modern
36	CP80 Layer	Piano	Vintage
37	CP80	Piano	Vintage
38	CP80 Amp	Piano	Vintage
39	CP80 Chorus	Piano	Vintage
40	CP80 & Pad	Piano	Vintage
41	FM Grand Piano	Piano	Vintage
42	FM Digi Ac Piano	Piano	Vintage
43	FM Bright Piano	Piano	Vintage
44	FM Ragtime Piano	Piano	Vintage
45	DX CP	Piano	Vintage
46	FM Toy Piano	Piano	Vintage
47	The Bridge	Piano	Acoustic
48	The Prepared Piano	Piano	Acoustic
49	CFX Chill	Piano	Acoustic
50	Rd 1 Gallery	Keyboard	Electric Piano
51	Rd 1 Gallery 2	Keyboard	Electric Piano
52	Rd 2 Gallery	Keyboard	Electric Piano
53	88 key Case Hard	Keyboard	Electric Piano
54	88 key Case Soft	Keyboard	Electric Piano
55	Case 73 Soft	Keyboard	Electric Piano
56	Case 75 Medium	Keyboard	Electric Piano
57	Case 75 Amp	Keyboard	Electric Piano
58	Case 78 Hard	Keyboard	Electric Piano
59	Rd 73	Keyboard	Electric Piano
60	Rd Old	Keyboard	Electric Piano
61	Rd Stage	Keyboard	Electric Piano
62	SuperDynoChorus DI	Keyboard	Electric Piano
63	SuperDynoChorusAmp	Keyboard	Electric Piano
64	Rd Echo	Keyboard	Electric Piano
65	74 Phase	Keyboard	Electric Piano
66	Rd Soft Touch Wah	Keyboard	Electric Piano
67	Rd Phase	Keyboard	Electric Piano
68	Dyno Chorus Rd	Keyboard	Electric Piano
69	Rd Scratched	Keyboard	Electric Piano
70	Rd 78 Brite Tremolo	Keyboard	Electric Piano

No.	Performance Name	Main Category	Sub Category
71	Rd 75 Soft Dist	Keyboard	Electric Piano
72	Neo R&B Clean	Keyboard	Electric Piano
73	Rd HD Warm Chorus	Keyboard	Electric Piano
74	J Phased Rd 73	Keyboard	Electric Piano
75	Tine Transformer	Keyboard	Electric Piano
76	Nu Hybrid EP	Keyboard	Electric Piano
77	Rd & Pad	Keyboard	Electric Piano
78	EP goes to 11	Keyboard	Electric Piano
79	Case 73 + FM	Keyboard	Electric Piano
80	Early 80s DiscoPop	Keyboard	Electric Piano
81	Wr Gallery	Keyboard	Electric Piano
82	Wr Gallery 2	Keyboard	Electric Piano
83	Wr EP 2	Keyboard	Electric Piano
84	Wr EP 2 Bright	Keyboard	Electric Piano
85	Wr Tremolo Amp	Keyboard	Electric Piano
86	Wr Amp	Keyboard	Electric Piano
87	Wr Rock	Keyboard	Electric Piano
88	Wr Pops	Keyboard	Electric Piano
89	Velo EP FX	Keyboard	Electric Piano
90	FM Wr 1	Keyboard	Electric Piano
91	FM Wr 2	Keyboard	Electric Piano
92	Ring Echo EP	Keyboard	Electric Piano
93	EP & Jazz Gt Comp	Keyboard	Electric Piano
94	Chill Me	Keyboard	Electric Piano
95	Wr 8ths	Keyboard	Electric Piano
96	FM Piano DA	Keyboard	FM Piano
97	SparkleDegree Full	Keyboard	FM Piano
98	FM - What else	Keyboard	FM Piano
99	GS E.Piano	Keyboard	FM Piano
100	FM EP Brite > Comp	Keyboard	FM Piano
101	FM Roads	Keyboard	FM Piano
102	EP 1980	Keyboard	FM Piano
103	DX Road	Keyboard	FM Piano
104	The FM E.Piano	Keyboard	FM Piano
105	DX FM EP	Keyboard	FM Piano
106	Heart of FM EP	Keyboard	FM Piano
107	Urban EP	Keyboard	FM Piano
108	Full Tine 2	Keyboard	FM Piano
109	Gentle FM EP	Keyboard	FM Piano
110	Mellow DX AF 1&2	Keyboard	FM Piano
111	TV Show FM EP	Keyboard	FM Piano
112	Glass Tines	Keyboard	FM Piano
113	Classic 80's DX7 EP	Keyboard	FM Piano
114	The TX816 E.Piano 1	Keyboard	FM Piano
115	The TX416 E.Piano 1	Keyboard	FM Piano
116	The TX816 E.Piano 2	Keyboard	FM Piano
117	The TX416 E.Piano 2	Keyboard	FM Piano
118	FM EP Plus	Keyboard	FM Piano
119	Margot's Song	Keyboard	FM Piano
120	FM Morph Keys	Keyboard	FM Piano
121	FM EP & Strings	Keyboard	FM Piano
122	Grace EP	Keyboard	FM Piano
123	FM Heavens Harp	Keyboard	FM Piano
124	Midnight Funk	Keyboard	FM Piano
125	FM EP Dyna Swell	Keyboard	FM Piano
126	Bell Tines	Keyboard	FM Piano
127	FM - What else X	Keyboard	FM Piano
128	DX Chill	Keyboard	FM Piano
129	Toy EP	Keyboard	Electric Piano
130	Toy EP Amp Hybrid	Keyboard	Electric Piano
131	Clavi Amp Gallery	Keyboard	Clavi
132	Nu Touch Clavi	Keyboard	Clavi
133	Super Clavi 2	Keyboard	Clavi
134	PhaserClavi Mt AF1	Keyboard	Clavi
135	Clavi/Toy EP Duo	Keyboard	Clavi
136	Power Clavi	Keyboard	Clavi
137	Clavi Touch Wah 2	Keyboard	Clavi
138	Clavi Amp Phaser AF1	Keyboard	Clavi
139	FM Clavi>FretlessB	Keyboard	Clavi
140	Clavi Stuff	Keyboard	Clavi

No.	Performance Name	Main Category	Sub Category
141	Hybrid Clavi	Keyboard	Clavi
142	EL Grand Clavi	Keyboard	Clavi
143	E.Harpsichord	Keyboard	Clavi
144	FM Harpsichord	Keyboard	Clavi
145	Harpsi > Celesta	Keyboard	Clavi
146	Easy Filter	Keyboard	Synth
147	All 9 Bars!	Organ	Tone Wheel
148	The Basics	Organ	Tone Wheel
149	8.8.8.8.6.2.2.0.0	Organ	Tone Wheel
150	8.8.8.8.6.2.2.0.0 2	Organ	Tone Wheel
151	Hot Smoky	Organ	Tone Wheel
152	J's Jazz	Organ	Tone Wheel
153	J's Jazz 2	Organ	Tone Wheel
154	Dave's Nu Organ	Organ	Tone Wheel
155	X Draw Organ	Organ	Tone Wheel
156	All Bar None	Organ	Tone Wheel
157	More Shade	Organ	Tone Wheel
158	The Jazz Organ	Organ	Tone Wheel
159	Jazz To All Out	Organ	Tone Wheel
160	Jazz To All Out 2	Organ	Tone Wheel
161	Gospel To Reggae	Organ	Tone Wheel
162	Curved To Straight	Organ	Tone Wheel
163	Groove Organ	Organ	Tone Wheel
164	The Preacher	Organ	Tone Wheel
165	The Preacher 2	Organ	Tone Wheel
166	Evens and Odds	Organ	Tone Wheel
167	Glassy	Organ	Tone Wheel
168	Two Blue Hands	Organ	Tone Wheel
169	Lovin' Happiness	Organ	Tone Wheel
170	Bowed Bars CV	Organ	Tone Wheel
171	The Grinder	Organ	Tone Wheel
172	Rock Organ 2	Organ	Tone Wheel
173	Overdriven Organ	Organ	Tone Wheel
174	Whiter Bars	Organ	Tone Wheel
175	Hybrid Organ	Organ	Tone Wheel
176	Rich Bars	Organ	Tone Wheel
177	Clarinet Bars	Organ	Tone Wheel
178	Rock Hard	Organ	Tone Wheel
179	Lake Fire	Organ	Tone Wheel
180	FM Full Organ	Organ	Tone Wheel
181	FM Draw Organ 1	Organ	Tone Wheel
182	FM Jazz Organ	Organ	Tone Wheel
183	FM Draw Organ 2	Organ	Tone Wheel
184	The FM DX7 Organ	Organ	Tone Wheel
185	FM Rock Organ 3	Organ	Tone Wheel
186	FM Rock Organ 4	Organ	Tone Wheel
187	Multi Bars Organ	Organ	Tone Wheel
188	Perc Alone	Organ	Tone Wheel
189	Up Close B	Organ	Tone Wheel
190	Go-Come Organ	Organ	Tone Wheel
191	FM YC Combo Organ	Organ	Combo
192	BOX FM Combo Organ	Organ	Combo
193	FM Perc Organ 1	Organ	Synth
194	FM Perc Organ 2	Organ	Synth
195	FM Perc Organ 3	Organ	Synth
196	FM Rock Organ 1	Organ	Synth
197	FM Rock Organ 2	Organ	Synth
198	Digital Tonewheels	Organ	Electronic
199	Bright Perc Organ	Organ	Synth
200	Foolish Organ	Organ	Rock/Pop
201	Flying Bars	Organ	Tone Wheel
202	Tempo Bars	Organ	Tone Wheel
203	Morse Organ	Organ	Tone Wheel
204	Cathedral	Organ	Pipe
205	Cathedral 2	Organ	Pipe
206	FM Church Pipes	Organ	Pipe
207	FM Pipe Organ	Organ	Pipe
208	FM Puff Organ	Organ	Pipe
209	FM Accordion 1	Organ	Pipe
210	FM Accordion 2	Organ	Pipe

No.	Performance Name	Main Category	Sub Category
211	AccordionTrnsfrmer	Organ	Pipe
212	Jahrmart	Organ	Pipe
213	ScotsAccordion MMM	Organ	Jazz/World
214	OrganSubBass Swell	Organ	Synth
215	Steel Twin Gallery	Guitar	Acoustic
216	6 String Finger	Guitar	Acoustic
217	Picked Son of Gt	Guitar	Acoustic
218	Fingered Steel	Guitar	Acoustic
219	Picked Steel	Guitar	Acoustic
220	Flamenco Guitar	Guitar	Acoustic
221	Fiesta Guitar	Guitar	Acoustic
222	Ac Chicken Pick	Guitar	Acoustic
223	Fingered 12 String	Guitar	Acoustic
224	American 12 String	Guitar	Acoustic
225	American Steel Duo	Guitar	Acoustic
226	Two Acoustics 2	Guitar	Acoustic
227	Songwriter 2015	Guitar	Acoustic
228	Serenity	Guitar	Acoustic
229	Proximity Effect	Guitar	Acoustic
230	Acoustic Jam	Guitar	Acoustic
231	8 Amps and a TC	Guitar	Electric Clean
232	Clean Fingers	Guitar	Electric Clean
233	TC Clean Pick	Guitar	Electric Clean
234	Clean BalladFinger	Guitar	Electric Clean
235	Clean Ballad Pick	Guitar	Electric Clean
236	American Garage	Guitar	Electric Clean
237	Texas Chicken Pick	Guitar	Electric Clean
238	Duo TC Clean	Guitar	Electric Clean
239	Hybrid 1coil E.Gtr	Guitar	Electric Clean
240	French Br ED	Guitar	Electric Clean
241	1 Finger Gangster	Guitar	Electric Clean
242	Lead Feedbacker	Guitar	Distortion
243	Comp Hero	Guitar	Distortion
244	Modern Finger Hero	Guitar	Distortion
245	Texas Chicken MW	Guitar	Distortion
246	Modern Pick Hero	Guitar	Distortion
247	Duo TC Drive	Guitar	Distortion
248	FM Ac Guitar 1	Guitar	Synth
249	FM Ac Guitar 2	Guitar	Synth
250	FM Pick Guitar 1	Guitar	Synth
251	FM Pick Guitar 2	Guitar	Synth
252	FM Tight Guitar	Guitar	Synth
253	FM EPish Guitar	Guitar	Synth
254	FM The Jazz Guitar	Guitar	Synth
255	FM Clean E.Gt 1	Guitar	Synth
256	FM Clean E.Gt 2	Guitar	Synth
257	FM Clean 12st E.Gt	Guitar	Synth
258	FM Clean E.Gt 3	Guitar	Synth
259	FM Mute E.Gt	Guitar	Synth
260	FM Distortion E.Gt	Guitar	Synth
261	Rock Star	Guitar	Synth
262	Upright Bass AF1	Bass	Acoustic
263	Bass+RideCym/Piano	Bass	Acoustic
264	New Grunge Bass	Bass	Synth
265	DX SuperBass+ DA	Bass	Synth
266	Bass Morpher	Bass	Synth
267	Dub Rock Bass	Bass	Synth
268	FM Boogie Syn Bass	Bass	Synth
269	FM The DX E.Bass	Bass	Synth
270	FM Hybrid Bass	Bass	Synth
271	FM Octaves	Bass	Synth
272	FM Wood Bass	Bass	Synth
273	FM Smooth WoodBass	Bass	Synth
274	FM Finger Bass	Bass	Synth
275	FM Prog Elec Bass	Bass	Synth
276	FM Pick Bass	Bass	Synth
277	FM Pick Pluck Bass	Bass	Synth
278	FM Owl Bass	Bass	Synth
279	FM Fretless Bass 1	Bass	Synth
280	FM Fretless Bass 2	Bass	Synth

No.	Performance Name	Main Category	Sub Category
281	FM Round Wound EB	Bass	Synth
282	FM Super Bass	Bass	Synth
283	FM SuperUnisonBass	Bass	Synth
284	FM Slap Bass	Bass	Synth
285	FM Syn Bass	Bass	Synth
286	FM Lately Bass	Bass	Synth
287	Judgement Bass	Bass	Synth
288	Round Sync	Bass	Synth
289	FM Flange Bass	Bass	Synth
290	Phat Bass	Bass	Synth
291	Johnny Bass	Bass	Synth
292	T3 Uber funk	Bass	Synth
293	Warped Bass Traxx	Bass	Synth
294	FM Abstracts	Bass	Synth
295	Tektonic Dub	Bass	Synth
296	Tremble Bass	Bass	Synth
297	Tear Bass	Bass	Synth
298	Sweep Motion Bass	Bass	Synth
299	FM Bouncer FX	Bass	Synth
300	Mr Producer	Bass	Synth
301	Chronic Circuits	Bass	Synth
302	Dub Me...SK	Bass	Synth
303	Mega Complexro	Bass	Electronic
304	The Frog	Bass	Electronic
305	Trap 'n' Bass	Bass	Electronic
306	Solo 1stViolin AF1	Strings	Solo
307	Solo 2ndViolin AF1	Strings	Solo
308	Celtic Violin	Strings	Solo
309	Secret Violin	Strings	Solo
310	Solo Viola AF1	Strings	Solo
311	Solo Cello AF1	Strings	Solo
312	Seattle Violins 1	Strings	Ensemble
313	Seattle Violins 2	Strings	Ensemble
314	Seattle Violas	Strings	Ensemble
315	Seattle Cellos	Strings	Ensemble
316	Seattle Basses	Strings	Ensemble
317	Chamber Strings	Strings	Ensemble
318	Ballad Strings	Strings	Ensemble
319	Classical Strings	Strings	Ensemble
320	Romance Strings	Strings	Ensemble
321	Seattle Sections	Strings	Ensemble
322	A Few Strings	Strings	Ensemble
323	Rich Strings	Strings	Ensemble
324	String Sect Swell	Strings	Ensemble
325	St Ensemble K	Strings	Ensemble
326	Strings & Brass	Strings	Ensemble
327	Strings&BrassSwell	Strings	Ensemble
328	Hybrid Violins	Strings	Ensemble
329	Hybrid Violas	Strings	Ensemble
330	Hybrid Cellos	Strings	Ensemble
331	Share The Shed	Strings	Ensemble
332	Concert Harp	Strings	Pizzicato
333	Mellow Harp	Strings	Pizzicato
334	CelticHarpEthereal	Strings	Pizzicato
335	Celtic Harp Choral	Strings	Pizzicato
336	FM Harp	Strings	Pizzicato
337	Disk Dusk	Strings	Pizzicato
338	Pizza Insomniato	Strings	Pizzicato
339	FM Strings	Strings	Synth
340	FM Syn Strings	Strings	Synth
341	FM Tron Strings	Strings	Synth
342	FM Square Strings	Strings	Synth
343	Yo Luv	Strings	Synth
344	Slow and Steady	Strings	Synth
345	Trumpet 3	Brass	Solo
346	Piccolo Trumpet	Brass	Solo
347	Scott's Teacher	Brass	Solo
348	Trombone	Brass	Solo
349	Bass Trombone	Brass	Solo
350	French Horn 2	Brass	Solo

No.	Performance Name	Main Category	Sub Category
351	Euphonium 2	Brass	Solo
352	Trumps and Bones	Brass	Solo
353	Attack Brass	Brass	Solo
354	Horn To Horns	Brass	Solo
355	Orch Trumpets	Brass	Orchestra
356	Trumpet Ensemble	Brass	Ensemble
357	Trumpets Swell	Brass	Ensemble
358	Orch Trombones	Brass	Orchestra
359	Trombone Ensemble	Brass	Ensemble
360	Trombones Swell	Brass	Ensemble
361	Orchestra Horns	Brass	Orchestra
362	Orchestral Horns	Brass	Orchestra
363	FrenchHornSection3	Brass	Ensemble
364	Fr Horns Swell	Brass	Ensemble
365	Orch Brass Tutti	Brass	Orchestra
366	Orch Brass Oct	Brass	Ensemble
367	Orchestral Brass	Brass	Ensemble
368	Orch Brass Swell	Brass	Ensemble
369	PopHorns Dyn Shake	Brass	Ensemble
370	Pop Horns Mellow	Brass	Ensemble
371	Modern Jazz Horns	Brass	Ensemble
372	Pop Horns Bright	Brass	Ensemble
373	Pop Horns Accent	Brass	Ensemble
374	Pop Horns Swell	Brass	Ensemble
375	Slow and Speedy	Brass	Ensemble
376	Pop Brass Swell	Brass	Ensemble
377	Trapped Brass!	Brass	Ensemble
378	Hybrid Ana Brass	Brass	Synth
379	Brassy Synth MW	Brass	Synth
380	FM Dual Trumpets	Brass	Synth
381	FM Horn	Brass	Synth
382	FM Mallet Horn	Brass	Synth
383	FM Alps Horn	Brass	Synth
384	FM GX1 Brass 1	Brass	Synth
385	FM GX1 Brass 2	Brass	Synth
386	DX Brass	Brass	Synth
387	FM Warm Brass	Brass	Synth
388	FM CS80 Brass	Brass	Synth
389	FM JP Brass	Brass	Synth
390	FM The Brass	Brass	Synth
391	FM Brass	Brass	Synth
392	FM BrassEnsemble 1	Brass	Synth
393	FM BrassEnsemble 2	Brass	Synth
394	The Synth Brass 1	Brass	Synth
395	The Synth Brass 2	Brass	Synth
396	PopBrass & SynBrass	Brass	Synth
397	The Hybrid BRASS Sec	Brass	Synth
398	Piccolo 2	Woodwind	Flute
399	Concert Flute	Woodwind	Flute
400	Latin Flutist	Woodwind	Flute
401	Penny Whistle	Woodwind	Flute
402	Low D Whistle	Woodwind	Flute
403	FM Pan Flute	Woodwind	Flute
404	Oboe 3	Woodwind	Woodwind
405	Orch Clarinet	Woodwind	Woodwind
406	Bassoon 3	Woodwind	Woodwind
407	Contra Bassoon	Woodwind	Woodwind
408	Wind Ensemble	Woodwind	Reed / Pipe
409	Inauguration	Woodwind	Woodwind
410	60s Movie Melody	Woodwind	Flute
411	FM Harmonica	Woodwind	Reed / Pipe
412	FM Saxophone	Woodwind	Saxophone
413	Singleline 2	Syn Lead	Analog
414	FM Vocal Lead	Syn Lead	Analog
415	Monster Lead	Syn Lead	Analog
416	MainRoomRiff Maker	Syn Lead	Dance
417	EDM PiTch Bomb	Syn Lead	Dance
418	3o3 Talker	Syn Lead	Dance
419	ComercialLd & Cmp	Syn Lead	Dance
420	Major Fazor	Syn Lead	Dance

No.	Performance Name	Main Category	Sub Category
421	FM MotionSeq Ld DA	Syn Lead	Digital
422	FM Sync	Syn Lead	Digital
423	FM Syn Lead 1	Syn Lead	Digital
424	FM Syn Lead 2	Syn Lead	Digital
425	FM SynLeadSubHarmo	Syn Lead	Digital
426	FM Syn Lead 3	Syn Lead	Digital
427	Anemone Lead	Syn Lead	Analog
428	Milk & Honey	Syn Lead	Analog
429	Milky Way	Syn Lead	Analog
430	Dust to Gold	Syn Lead	Digital
431	Soft and Dirty FM	Syn Lead	Digital
432	Kool FM Disco Lead	Syn Lead	Digital
433	Hybrid Sync	Syn Lead	Digital
434	Mr. Coin	Syn Lead	Digital
435	FM Motion Lead	Syn Lead	Digital
436	Radiation	Syn Lead	Digital
437	Synchronizers	Syn Lead	Digital
438	Motion Grid	Syn Lead	Digital
439	Aogashima	Syn Lead	Analog
440	Star Poly	Syn Lead	Analog
441	Double Triller	Syn Lead	Digital
442	Arcade	Syn Lead	Dance
443	Growling Wolf	Syn Lead	Dance
444	Legato Pitcher	Syn Lead	Dance
445	Catatonix	Syn Lead	Dance
446	Electronix Chat	Syn Lead	Dance
447	Freaky Dancer	Syn Lead	Electronic
448	Flying Dub	Syn Lead	Digital
449	Illuminator	Syn Lead	Dance
450	WaveRunner MW DA	Syn Lead	Digital
451	SuperGlider MW DA	Syn Lead	Digital
452	Reflection Twinkle	Syn Lead	Analog
453	Synth Noise Vocoder	Syn Lead	Analog
454	Wax And Wane	Pad/Choir	Bright
455	Trigger Horizon	Pad/Choir	Bright
456	Chillomatik	Pad/Choir	Bright
457	Padderday	Pad/Choir	Bright
458	DX Classix	Pad/Choir	Bright
459	PITCh Up Vowel Pad	Pad/Choir	Bright
460	Dreamy FM Keys	Pad/Choir	Bright
461	FM Astral Pad	Pad/Choir	Bright
462	FM Double Filtered	Pad/Choir	Bright
463	Fizzy FM Mod Pad	Pad/Choir	Bright
464	Deep Filter Kino	Pad/Choir	Bright
465	Deep Pitch Kino	Pad/Choir	Bright
466	FM PWM Pad	Pad/Choir	Bright
467	FM Forest Pad	Pad/Choir	Bright
468	FM Bell SquarePad	Pad/Choir	Bright
469	Poly Pad MW DA	Pad/Choir	Bright
470	FM Ice Heaven Pad	Pad/Choir	Bright
471	FM Bow RingMod Pad	Pad/Choir	Bright
472	FM Crystal Pad	Pad/Choir	Bright
473	FM 5th Pad	Pad/Choir	Bright
474	Schlager Weapon 4	Pad/Choir	Bright
475	FM Strings & Bells	Pad/Choir	Bright
476	HyperTrance Stereo	Pad/Choir	Bright
477	Fluctuations	Pad/Choir	Bright
478	Introduce Me	Pad/Choir	Bright
479	Satellite	Pad/Choir	Bright
480	Ethereal	Pad/Choir	Warm
481	Ocean Pad	Pad/Choir	Warm
482	Isle of Skye	Pad/Choir	Warm
483	Momentary FM	Pad/Choir	Warm
484	Stardust FM	Pad/Choir	Warm
485	FM Warm Shivers	Pad/Choir	Warm
486	Nu Age Designer FM	Pad/Choir	Warm
487	FM Slow Square Pad	Pad/Choir	Warm
488	Tranquility AF1&2	Pad/Choir	Warm
489	FM Film Pad	Pad/Choir	Warm
490	FM Saw Pad	Pad/Choir	Warm

No.	Performance Name	Main Category	Sub Category
491	FM Cloud Sine Pad	Pad/Choir	Warm
492	Apollo	Pad/Choir	Warm
493	FM Heavenly Pad	Pad/Choir	Warm
494	FM Ambient Keys	Pad/Choir	Warm
495	Rotary Bell Voices	Pad/Choir	Warm
496	Groovin Spheres	Pad/Choir	Warm
497	Whip Motion	Pad/Choir	Warm
498	Snow Run	Pad/Choir	Warm
499	Creation	Pad/Choir	Warm
500	Universal Comp	Pad/Choir	Analog
501	Square don't care	Pad/Choir	Analog
502	Octo Supreme	Pad/Choir	Analog
503	UnderWater Worlds	Pad/Choir	Analog
504	R's Logo	Pad/Choir	Analog
505	FM Sweeping Poly	Pad/Choir	Analog
506	Firey Pad	Pad/Choir	Analog
507	That's a Pad	Pad/Choir	Analog
508	FM Analogy Pad	Pad/Choir	Analog
509	FM Sweep AnalogPad	Pad/Choir	Analog
510	SinePad<->Strs<->Nz	Pad/Choir	Analog
511	New Groove Pad	Pad/Choir	Analog
512	Meteor Shower	Pad/Choir	Electronic
513	Subspace Oceans	Pad/Choir	Electronic
514	Choir Service	Pad/Choir	Choir
515	Gospel Hmm	Pad/Choir	Choir
516	Gospel Wow	Pad/Choir	Choir
517	Gospel Hey	Pad/Choir	Choir
518	Latin Vocal	Pad/Choir	Choir
519	Jazz Singers	Pad/Choir	Choir
520	BoysChoir MW Xfade	Pad/Choir	Choir
521	FM Choir	Pad/Choir	Choir
522	Choir/Str/Pipe Org	Pad/Choir	Choir
523	FM Linear Synth	Pad/Choir	Bright
524	Color Wheel	Pad/Choir	Bright
525	Drift & Pulse	Pad/Choir	Bright
526	Filter & Funky	Pad/Choir	Bright
527	Chilled Vocoder	Pad/Choir	Bright
528	Scorpius	Pad/Choir	Bright
529	Flexi Filters AF1&2	Pad/Choir	Bright
530	Morph Waveforms	Pad/Choir	Bright
531	Orient Envelope	Pad/Choir	Bright
532	Art Strealla	Pad/Choir	Analog
533	Funk Motion Pad	Pad/Choir	Analog
534	Praise Mr. 80	Pad/Choir	Analog
535	Vintage Arp LFO	Pad/Choir	Analog
536	Power of Emotion	Pad/Choir	Analog
537	The Golden Key	Pad/Choir	Analog
538	Pink Oracle	Pad/Choir	Analog
539	Particles in Space	Pad/Choir	Analog
540	Galactic Nucleus	Pad/Choir	Analog
541	Glistening Grove	Pad/Choir	Analog
542	Motion PAD & ARP	Pad/Choir	Analog
543	Polyphonic LFOs	Pad/Choir	Analog
544	Journey Within	Pad/Choir	Analog
545	Deep Dreams	Pad/Choir	Analog
546	Cloud Electric	Pad/Choir	Analog
547	Choir SEQ	Pad/Choir	Choir
548	Envelope Seq Scenes	Pad/Choir	Choir
549	Spaced Voices	Pad/Choir	Choir
550	Free Running	Pad/Choir	Warm
551	The Great Red Spot	Pad/Choir	Warm
552	Particle Pad	Pad/Choir	Electronic
553	Increasing Tension	Pad/Choir	Electronic
554	EDM Fun 2	Pad/Choir	Bright
555	EDM Fun 1	Pad/Choir	Bright
556	Schlager Herz	Pad/Choir	Analog
557	Mr. Side Chain	Pad/Choir	Analog
558	Chart Topper	Pad/Choir	Analog
559	Travel Frontiers	Pad/Choir	Analog
560	Ethno ARP Beat	Pad/Choir	Analog

No.	Performance Name	Main Category	Sub Category
561	Honeyfaces	Pad/Choir	Warm
562	One Chord EDM	Pad/Choir	Analog
563	Chasing Clouds	Pad/Choir	Warm
564	Breathless Safri	Syn Comp	Analog
565	Pluck Away	Syn Comp	Analog
566	One&Only massive	Syn Comp	Analog
567	FM Harpune AF1&2	Syn Comp	Decay
568	FM Atmos Decay	Syn Comp	Decay
569	FM Baroque Decay	Syn Comp	Decay
570	FM Koto & Shamisen	Syn Comp	Decay
571	Percussive Dance 2	Syn Comp	Decay
572	Rising Comp	Syn Comp	Decay
573	90s Harp	Syn Comp	Digital
574	Schlager Weapon 2	Syn Comp	Digital
575	Turn It On	Syn Comp	Digital
576	Kool Dis Comp	Syn Comp	Digital
577	Saws Vs Bells	Syn Comp	Digital
578	FM Comper	Syn Comp	Digital
579	Schlager Weapon 3	Syn Comp	Digital
580	FM Wave Dreams	Syn Comp	Digital
581	FM Polyesterday	Syn Comp	Digital
582	Angel Hood	Syn Comp	Digital
583	Hybrid Comp	Syn Comp	Digital
584	Fusion Keys	Syn Comp	Digital
585	FM Hard Comp	Syn Comp	Digital
586	FM Brite Comp	Syn Comp	Digital
587	Epiphany	Syn Comp	Digital
588	FM India Ethnic	Syn Comp	Digital
589	FM Two Kalimbas	Syn Comp	Digital
590	FM Funky Companion	Syn Comp	Digital
591	FM Clabgrass	Syn Comp	Digital
592	Red Ones	Syn Comp	Digital
593	EDM Chord Playa	Syn Comp	Digital
594	Dynamic Pad	Syn Comp	Digital
595	ArpFilteredSynth	Syn Comp	Digital
596	LaidBack House	Syn Comp	Digital
597	Multi Saw MW DA	Syn Comp	Hook
598	Dance Synth MW DA	Syn Comp	Hook
599	Percussive Dance	Syn Comp	Hook
600	Mega Stack	Syn Comp	Hook
601	Power Hook	Syn Comp	Hook
602	Dance Survivor	Syn Comp	Hook
603	FM&AN Classic Arps	Syn Comp	Digital
604	Caramel Ice	Syn Comp	Analog
605	DJ Montage	Syn Comp	Decay
606	DNA Lounge	Syn Comp	Decay
607	Solaris	Syn Comp	Decay
608	Crumbler	Syn Comp	Digital
609	Moving Floor	Syn Comp	Digital
610	Hands Up!	Syn Comp	Hook
611	Horizon	Syn Comp	Digital
612	Trance Master	Syn Comp	Hook
613	Spark Saw	Syn Comp	Hook
614	my saw	Syn Comp	Hook
615	Bell Majestic	Chromatic Perc	Bell
616	Expanded DX Bells	Chromatic Perc	Bell
617	Far Away FM	Chromatic Perc	Bell
618	FM Music Box	Chromatic Perc	Bell
619	FM Carillon	Chromatic Perc	Bell
620	Glassbell Pindrops	Chromatic Perc	Bell
621	Vibraphone MotorOn	Chromatic Perc	Mallet
622	Orch Xylophone	Chromatic Perc	Mallet
623	Orch Marimba	Chromatic Perc	Mallet
624	Orch Glockenspiel	Chromatic Perc	Mallet
625	FM Woody Keys	Chromatic Perc	Mallet
626	FM Vibe 1	Chromatic Perc	Mallet
627	FM Vibe 2	Chromatic Perc	Mallet
628	FM Marimba	Chromatic Perc	Mallet
629	FM Xylophone	Chromatic Perc	Mallet
630	FM Marimba Guitar	Chromatic Perc	Mallet

No.	Performance Name	Main Category	Sub Category
631	FM Celesta	Chromatic Perc	Mallet
632	FM Glocken	Chromatic Perc	Mallet
633	FM Metal Glocken	Chromatic Perc	Mallet
634	FM Lullaby AF1&2	Chromatic Perc	Mallet
635	Beaten Gong	Chromatic Perc	Mallet
636	Shape of Marimbas	Chromatic Perc	Mallet
637	Ethno Festivo	Chromatic Perc	Mallet
638	FM Vibraphone	Chromatic Perc	Electronic
639	Haccato Steaven	Chromatic Perc	Synth Bell
640	Fantasy	Chromatic Perc	Synth Bell
641	FM Fantasy	Chromatic Perc	Synth Bell
642	FM Vari Bell	Chromatic Perc	Synth Bell
643	FM Tubular Bells	Chromatic Perc	Synth Bell
644	FM Hand Bell	Chromatic Perc	Synth Bell
645	Super Bell	Chromatic Perc	Synth Bell
646	FM Smart Bells	Chromatic Perc	Synth Bell
647	FM Dulcimer	Chromatic Perc	Pitched Drum
648	FM Steel Drum	Chromatic Perc	Pitched Drum
649	FM Japanese Taiko	Chromatic Perc	Pitched Drum
650	FM Electric Drums	Chromatic Perc	Pitched Drum
651	Real Drums Kit	Drum / Perc	Drums
652	Real Drums Kit 2	Drum / Perc	Drums
653	New Oak Custom Kit	Drum / Perc	Drums
654	NewMapleCustom Kit	Drum / Perc	Drums
655	BeechwoodSnare Kit	Drum / Perc	Drums
656	BeechwoodSnareKit2	Drum / Perc	Drums
657	Real Brushes Kit	Drum / Perc	Drums
658	Jazz Brushes Kit	Drum / Perc	Drums
659	Jazz Sticks Kit	Drum / Perc	Drums
660	D'elo Kit	Drum / Perc	Drums
661	T's EDM Kit	Drum / Perc	Drums
662	T's EDM Kit 2	Drum / Perc	Drums
663	T's Hip Hop Kit	Drum / Perc	Drums
664	T's Hip Hop Kit 2	Drum / Perc	Drums
665	Trap Kit	Drum / Perc	Drums
666	Trap Kit 2	Drum / Perc	Drums
667	Downtempo HipHop Kit	Drum / Perc	Drums
668	EDM Kit	Drum / Perc	Drums
669	House-Techno Kit	Drum / Perc	Drums
670	House-Techno Kit 2	Drum / Perc	Drums
671	Electro Kit	Drum / Perc	Drums
672	Electro Kit 2	Drum / Perc	Drums
673	DUB Kit	Drum / Perc	Drums
674	DUB Kit 2	Drum / Perc	Drums
675	European EDM Kit 1	Drum / Perc	Drums
676	European EDM Kit 2	Drum / Perc	Drums
677	Dancefloor Kit	Drum / Perc	Drums
678	Dancefloor Kit 2	Drum / Perc	Drums
679	Psychedelic Dub Kit	Drum / Perc	Drums
680	Brachial Kit	Drum / Perc	Drums
681	Epic Kit	Drum / Perc	Drums
682	Arabic Mixed Kit 2	Drum / Perc	Drums
683	Iranian Mix Kit	Drum / Perc	Drums
684	Modern Rock Kit 2	Drum / Perc	Drums
685	Brazil Kit 1	Drum / Perc	Percussion
686	Brazil Kit 2	Drum / Perc	Percussion
687	Turkish St Kit	Drum / Perc	Percussion
688	New Arabic Kit 1	Drum / Perc	Percussion
689	New Arabic Kit 2	Drum / Perc	Percussion
690	New Maghrebi Kit	Drum / Perc	Percussion
691	New Khaligi Kit 1	Drum / Perc	Percussion
692	New Khaligi Kit 2	Drum / Perc	Percussion
693	New Iranian Kit 1	Drum / Perc	Percussion
694	New Iranian Kit 2	Drum / Perc	Percussion
695	Darbuka Sagat Riq	Drum / Perc	Percussion
696	Bodhran&Cajon Kit	Drum / Perc	Percussion
697	Bones&Spoons Kit	Drum / Perc	Percussion
698	Highland Snares	Drum / Perc	Percussion
699	Experimental Work	Drum / Perc	Electronic
700	Flix Flux FM	Drum / Perc	Electronic

No.	Performance Name	Main Category	Sub Category
701	FM Techre	Drum / Perc	Electronic
702	FM Scraper	Drum / Perc	Electronic
703	DubStepping	Drum / Perc	Drums
704	Minimal Techno	Drum / Perc	Drums
705	Surprise Package	Drum / Perc	Drums
706	ATL Flexin	Drum / Perc	Drums
707	Infamous	Drum / Perc	Drums
708	Plastic Beat	Drum / Perc	Drums
709	Bodhran Scrape	Drum / Perc	Percussion
710	Handcussion	Drum / Perc	Percussion
711	Scatter Dance	Drum / Perc	Percussion
712	FM Landscapes	Sound FX	Electronic
713	FM Flight	Sound FX	Moving
714	FM The Wave	Sound FX	Nature
715	Warp Speed Atmos	Sound FX	Moving
716	Telharmonics	Sound FX	Moving
717	MOON BASE	Sound FX	Moving
718	Spiral Feedbacker	Sound FX	Moving
719	Spirals	Sound FX	Moving
720	4Bar1NoteRisers	Sound FX	Moving
721	Galactic Static	Sound FX	Sci-Fi
722	Robot Junkyard	Sound FX	Sci-Fi
723	Entropy	Sound FX	Sci-Fi
724	Blaster Beam	Sound FX	Sci-Fi
725	InsideTheWormhole	Sound FX	Moving
726	Creeping Voltage	Sound FX	Electronic
727	Start The Machine	Sound FX	Electronic
728	Dernr to Bwow	Sound FX	Ambient
729	Sentimental Boy	Musical FX	Ambient
730	The Green Flash	Musical FX	Ambient
731	FM For Airports	Musical FX	Ambient
732	Slow Fast	Musical FX	Electronic
733	Smartbar Funk	Musical FX	Electronic
734	Fusion Science	Musical FX	Electronic
735	Kreuzberg Funk	Musical FX	Electronic
736	Electro Boo	Musical FX	Electronic
737	More & More	Musical FX	Electronic
738	Magnetism	Musical FX	Electronic
739	Freaky FM AF1&2	Musical FX	Electronic
740	Electron	Musical FX	Electronic
741	Envelope Beatz	Musical FX	Electronic
742	Tribaltronic	Musical FX	Electronic
743	Electrone	Musical FX	Electronic
744	CirrocumulusClouds	Musical FX	Jazz/World
745	FM Tribal Council	Musical FX	Jazz/World
746	Cricket Night	Musical FX	Sweep
747	Canterbury Tales	Musical FX	Moving
748	FM Chillout	Musical FX	Moving
749	Pearly Gates	Musical FX	Moving
750	Thursday Evening	Musical FX	Moving
751	Marine Life	Musical FX	Moving
752	Wave Surfer	Musical FX	Moving
753	The Undecided	Musical FX	Moving
754	Motion Sweep	Musical FX	Moving
755	Bit Performer	Musical FX	Moving
756	Pacific	Musical FX	Moving
757	Pond Ripples	Musical FX	Moving
758	Emerald Forest	Musical FX	Moving
759	Piano Asylum	Musical FX	Moving
760	Pad Pulsations	Musical FX	Moving
761	Motion Filters AF	Musical FX	Moving
762	Turn It Up! AF1&2	Musical FX	Moving
763	Waveseq FM	Musical FX	Moving
764	FM Wallop	Musical FX	Moving
765	Iceworld	Musical FX	Moving
766	Fax Science	Musical FX	Moving
767	FM Spectral Spheres	Musical FX	Moving
768	Granular Motion	Musical FX	Moving
769	Mysterious Invention	Musical FX	Moving
770	M-Seq Choir Pad	Musical FX	Moving

No.	Performance Name	Main Category	Sub Category
771	Cold Motion	Musical FX	Moving
772	Shades of Yesterday	Musical FX	Moving
773	Shaking Trees	Musical FX	Moving
774	Hypnosis	Musical FX	Moving
775	Cliff	Musical FX	Moving
776	Vocal&Marim Ld	Musical FX	Moving
777	Vocal&Marim Ld 2	Musical FX	Moving
778	VoxTriX	Musical FX	Moving
779	FM Spiral Dist	Musical FX	Ambient
780	Shapeshifter	Musical FX	Moving
781	Hot Corner	Musical FX	Moving
782	Run It	Musical FX	R&B/Hip Hop
783	Under Dirt	Musical FX	R&B/Hip Hop
784	Rock Ready	Musical FX	Rock/Pop
785	Motion Pad	Musical FX	Sweep
786	EDM SideChainer	Musical FX	Sweep
787	Santur-A-Delic	Ethnic	Struck
788	African Garage Beat	Ethnic	Jazz/World
789	Vocoder & Follower	Pad/Choir	Choir
790	Vocoder Dance	Pad/Choir	Choir
791	Full Concert Grand	Piano	Acoustic
792	Rock Grand Piano	Piano	Modern
793	Mellow Grand Piano	Piano	Acoustic
794	Glasgow	Piano	Acoustic
795	Romantic Piano	Piano	Acoustic
796	Aggressive Grand	Piano	Modern
797	Tacky	Piano	Modern
798	House Piano	Piano	Modern
799	Old and Squashed	Piano	Vintage
800	Ballad Key	Piano	Layer
801	80s Layer	Piano	Layer
802	Ballad Stack	Piano	Layer
803	Piano Back	Piano	Layer
804	Piano & Strings	Piano	Layer
805	Piano & Ooh Choir	Piano	Layer
806	Monaural Grand MW	Piano	Acoustic
807	Old Blues	Piano	Vintage
808	1968	Piano	Vintage
809	CP 1979	Piano	Vintage
810	CP70 Chorus	Piano	Vintage
811	Journey	Piano	Vintage
812	Vintage'74	Keyboard	Electric Piano
813	R&B Soft	Keyboard	Electric Piano
814	Early 70's	Keyboard	Electric Piano
815	Soft Case	Keyboard	Electric Piano
816	Crunchy Comp	Keyboard	Electric Piano
817	Vintage Case	Keyboard	Electric Piano
818	Hard Vintage	Keyboard	Electric Piano
819	Sweetness MW	Keyboard	Electric Piano
820	Phaser Vintage	Keyboard	Electric Piano
821	Vintage Phase	Keyboard	Electric Piano
822	Early Fusion	Keyboard	Electric Piano
823	Neo Soul MW	Keyboard	Electric Piano
824	1983 MW	Keyboard	Electric Piano
825	Contempo	Keyboard	Electric Piano
826	Clicky Dyno MW	Keyboard	Electric Piano
827	DynoStraightMW	Keyboard	Electric Piano
828	Dyno Chorus MW	Keyboard	Electric Piano
829	80s Boosted	Keyboard	Electric Piano
830	Chorus Hard	Keyboard	Electric Piano
831	Max Tine	Keyboard	Electric Piano
832	Bell Chorus	Keyboard	FM Piano
833	Drive EP	Keyboard	Electric Piano
834	Vinyl EP	Keyboard	Electric Piano
835	Natural Wr	Keyboard	Electric Piano
836	Wr EP 1 Bright	Keyboard	Electric Piano
837	Wr Distortion	Keyboard	Electric Piano
838	Phaze Wr	Keyboard	Electric Piano
839	DX Legend	Keyboard	FM Piano
840	Bell DX	Keyboard	FM Piano

No.	Performance Name	Main Category	Sub Category
841	DX Woody	Keyboard	FM Piano
842	Full Tine 1	Keyboard	FM Piano
843	DX Mellow	Keyboard	FM Piano
844	DX Crisp	Keyboard	FM Piano
845	DX Celesta EP	Keyboard	FM Piano
846	DX Pluck EP	Keyboard	FM Piano
847	DX-7 II	Keyboard	FM Piano
848	GS Tines AF1&2	Keyboard	FM Piano
849	Galaxy DX	Keyboard	FM Piano
850	TX816 Bell Piano	Keyboard	FM Piano
851	Marimba DX	Keyboard	FM Piano
852	DX5-Zero	Keyboard	FM Piano
853	Hybrid EP	Keyboard	Electric Piano
854	Mixed Up	Keyboard	Electric Piano
855	Dyno Wr	Keyboard	Electric Piano
856	Analog Piano	Keyboard	Synth
857	AhrAml	Keyboard	Synth
858	Electro Piano	Keyboard	Electric Piano
859	Transistor Piano	Keyboard	Synth
860	EP Pad	Keyboard	Electric Piano
861	DX Pad	Keyboard	Electric Piano
862	Dyno Choir	Keyboard	Electric Piano
863	Vintage Clavi	Keyboard	Clavi
864	Super Clavi 1	Keyboard	Clavi
865	Stereo Clavi	Keyboard	Clavi
866	Hollow Clavi	Keyboard	Clavi
867	Nu Phasing	Keyboard	Clavi
868	Touch Clavi	Keyboard	Clavi
869	PedalWah Clavi FC2	Keyboard	Clavi
870	Pulse Clavi	Keyboard	Clavi
871	Guitarpsichord	Keyboard	Clavi
872	Hipsichord	Keyboard	Clavi
873	16 + 8 + 5&1/3	Organ	Tone Wheel
874	Jazz 2nd Perc + C3	Organ	Tone Wheel
875	First 3 w/Perc	Organ	Tone Wheel
876	Slow Jam	Organ	Tone Wheel
877	Cool Cat	Organ	Tone Wheel
878	Jazzy 1	Organ	Tone Wheel
879	Jazzy 2	Organ	Tone Wheel
880	Jazzy Chorus	Organ	Tone Wheel
881	On Road	Organ	Tone Wheel
882	Progressy	Organ	Tone Wheel
883	Rocky	Organ	Tone Wheel
884	Crunchy	Organ	Tone Wheel
885	1972	Organ	Combo
886	Glassy AF1	Organ	Tone Wheel
887	Clean	Organ	Tone Wheel
888	All Bars Perc AF	Organ	Tone Wheel
889	Rotor Vibrato	Organ	Tone Wheel
890	Vib Chorus AF1	Organ	Tone Wheel
891	Souleln	Organ	Tone Wheel
892	Mellow	Organ	Tone Wheel
893	Fully	Organ	Tone Wheel
894	FullDraw/CVibrato	Organ	Tone Wheel
895	Even Out	Organ	Tone Wheel
896	Harmonic Hole	Organ	Tone Wheel
897	A Few Wheels	Organ	Tone Wheel
898	Left Manual	Organ	Tone Wheel
899	Draw Control	Organ	Tone Wheel
900	Stop Rotar	Organ	Tone Wheel
901	Clean Noise	Organ	Tone Wheel
902	Walking Bass	Organ	Tone Wheel
903	Greasy	Organ	Tone Wheel
904	Swishie	Organ	Tone Wheel
905	Solo Percussion AF	Organ	Tone Wheel
906	Percussion Vibrato	Organ	Tone Wheel
907	Tiny Combo Bars 1	Organ	Combo
908	Tiny Combo Bars 2	Organ	Combo
909	Panther	Organ	Combo
910	1967 Keys	Organ	Combo

No.	Performance Name	Main Category	Sub Category
911	YD-45C	Organ	Combo
912	Diamond Head	Organ	Synth
913	Early Bird	Organ	Tone Wheel
914	Moet	Organ	Synth
915	Bollinger	Organ	Synth
916	Vinyl Organ	Organ	Synth
917	Alternator	Organ	Tone Wheel
918	Flying Rhythm Bars	Organ	Synth
919	Roundabout	Organ	Electronic
920	Tradi	Organ	Tone Wheel
921	Petit	Organ	Tone Wheel
922	Fluty	Organ	Tone Wheel
923	Fluty Pipe	Organ	Pipe
924	St. Peter	Organ	Pipe
925	St. Paul AF1&2	Organ	Pipe
926	Impromptu	Organ	Pipe
927	Mixture	Organ	Pipe
928	Reed Split	Organ	Pipe
929	Medieval MW	Organ	Pipe
930	Breath Pipe	Organ	Pipe
931	Reedy Pipe	Organ	Pipe
932	Sunday	Organ	Pipe
933	Accordions AF1&2	Organ	Pipe
934	Soft Marimba	Chromatic Perc	Mallet
935	Vibes Bow MW	Chromatic Perc	Mallet
936	Twinkle	Chromatic Perc	Bell
937	Stick Bell	Chromatic Perc	Bell
938	Ice Bells	Chromatic Perc	Bell
939	Bell Ice	Chromatic Perc	Bell
940	Stack Bell	Chromatic Perc	Synth Bell
941	J-Pop	Chromatic Perc	Bell
942	Chorus Bell	Chromatic Perc	Bell
943	Handbell	Chromatic Perc	Bell
944	Bell Chiff	Chromatic Perc	Synth Bell
945	Sako Bell	Chromatic Perc	Synth Bell
946	Nice Bell	Chromatic Perc	Synth Bell
947	Noisy Bell	Chromatic Perc	Synth Bell
948	Pop Bells & Pad MW	Chromatic Perc	Bell
949	Going To Heaven	Chromatic Perc	Rock/Pop
950	Digibox	Chromatic Perc	Synth Bell
951	Nibelungen	Chromatic Perc	Bell
952	Wood Bell	Chromatic Perc	Bell
953	Marimbell	Chromatic Perc	Synth Bell
954	Synth Steel Drum	Chromatic Perc	Pitched Drum
955	Gamelan	Chromatic Perc	Bell
956	Ethnic Dream	Chromatic Perc	Mallet
957	Mystic Bowl	Chromatic Perc	Bell
958	Mbira	Ethnic	Plucked
959	Glass Mbira	Chromatic Perc	Pitched Drum
960	Island Bell	Chromatic Perc	Synth Bell
961	Tibetan	Chromatic Perc	Bell
962	Rimba Bells	Chromatic Perc	Synth Bell
963	Lost in Asia	Chromatic Perc	Bell
964	Coconuts Random	Chromatic Perc	Jazz/World
965	Kodo	Chromatic Perc	Pitched Drum
966	Timp/Bell/Glocken	Chromatic Perc	Bell
967	Orc Percussion	Chromatic Perc	Bell
968	Classical AF1&2	Guitar	Acoustic
969	High Tension AF1&2	Guitar	Acoustic
970	Sao Paulo	Guitar	Acoustic
971	Barcelona	Guitar	Acoustic
972	Nylon Slide Vel	Guitar	Acoustic
973	NylonHarmonics Vel	Guitar	Acoustic
974	Classical12Strings	Guitar	Acoustic
975	Hip-HopNylonGuitar	Guitar	Acoustic
976	Steel String AF1&2	Guitar	Acoustic
977	Old Strings AF1&2	Guitar	Acoustic
978	Steel Slide Vel	Guitar	Acoustic
979	Mute & Slide Vel	Guitar	Acoustic
980	SteelHarmonics Vel	Guitar	Acoustic

No.	Performance Name	Main Category	Sub Category
981	Hip-HopSteelGuitar	Guitar	Acoustic
982	Hi Strings	Guitar	Acoustic
983	Two Acoustics 1	Guitar	Acoustic
984	2 Steel Strings	Guitar	Acoustic
985	Big 12 Strings	Guitar	Acoustic
986	Airy 12 AF1&2	Guitar	Acoustic
987	Wide 12 strings AF	Guitar	Acoustic
988	12Strings Mono	Guitar	Acoustic
989	Clean EI & Ac 1	Guitar	Electric Clean
990	Clean EI & Ac 2	Guitar	Electric Clean
991	Clean EI & Ac 3	Guitar	Electric Clean
992	Strange 12	Guitar	Electric Clean
993	Jazzy Pick	Guitar	Electric Clean
994	Melodic Jazz	Guitar	Electric Clean
995	Fat Oil Jazz AF1&2	Guitar	Electric Clean
996	Touch Wah AF1	Guitar	Electric Clean
997	Baby AF1	Guitar	Electric Clean
998	Good Night	Guitar	Electric Clean
999	Dynamic Clean AF	Guitar	Electric Clean
1000	Single Coil Chorus	Guitar	Electric Clean
1001	Distant	Guitar	Electric Clean
1002	Some Hair	Guitar	Distortion
1003	Clean Slide Vel	Guitar	Electric Clean
1004	Hit It Hard	Guitar	Electric Clean
1005	Paddy Clean	Guitar	Electric Clean
1006	BluesyClean Legato	Guitar	Electric Clean
1007	Dual Coil '65	Guitar	Distortion
1008	Dual Coil Amp	Guitar	Electric Clean
1009	Roto Guitar MW	Guitar	Electric Clean
1010	Dual Coil SlideVel	Guitar	Electric Clean
1011	Dual Coil Slap Vel	Guitar	Electric Clean
1012	Dual Coil 80sClean	Guitar	Electric Clean
1013	Dual Coil Rotary	Guitar	Electric Clean
1014	Electric 12Strings	Guitar	Electric Clean
1015	Rotator AF1&2	Guitar	Distortion
1016	Middy Tremolo	Guitar	Distortion
1017	Retro Flanger	Guitar	Electric Clean
1018	Vintage Strum	Guitar	Electric Clean
1019	Spanky	Guitar	Distortion
1020	Rockabilly	Guitar	Distortion
1021	2 Electrics AF1&2	Guitar	Electric Clean
1022	Light Blues AF1&2	Guitar	Distortion
1023	DualCoil SemiClean	Guitar	Electric Clean
1024	Chorus Dist AF1&2	Guitar	Distortion
1025	Tex Boogie	Guitar	Distortion
1026	59 Combo AF1&2	Guitar	Distortion
1027	Alternative Rocker	Guitar	Distortion
1028	Overdrive Mt&Harmo	Guitar	Distortion
1029	Crunched Up 376	Guitar	Distortion
1030	Dynamic Amp	Guitar	Distortion
1031	Chuggin' Guitar	Guitar	Distortion
1032	Chugga	Guitar	Distortion
1033	Small Amp	Guitar	Distortion
1034	Metal Mute	Guitar	Distortion
1035	DistortionMt&Harmo	Guitar	Distortion
1036	Cool Drive	Guitar	Distortion
1037	Hard Drive	Guitar	Distortion
1038	Hard Ramp	Guitar	Distortion
1039	Heavy Drive	Guitar	Distortion
1040	No.1 GTR	Guitar	Distortion
1041	Snake Finger	Guitar	Distortion
1042	Dual Coil BlueLead	Guitar	Distortion
1043	Over The Top	Guitar	Distortion
1044	VoodooMan	Guitar	Distortion
1045	Killer Whammy	Guitar	Distortion
1046	Latin Lover	Guitar	Distortion
1047	Oct Fuzz PdWah FC2	Guitar	Distortion
1048	DualCoilLeadWahFC2	Guitar	Distortion
1049	DualCoil Harmo Vel	Guitar	Distortion
1050	Crunchy Guitar	Guitar	Distortion

No.	Performance Name	Main Category	Sub Category
1051	Beater	Guitar	Distortion
1052	HIP Mute	Guitar	Electric Clean
1053	Pedal Steel	Guitar	Electric Clean
1054	DualCoil80sCleanMt	Guitar	Electric Clean
1055	Mid Drive(2handGt)	Guitar	Distortion
1056	HrdRocker(2handGt)	Guitar	Distortion
1057	ToughTube(2handGt)	Guitar	Distortion
1058	DriveWah (2handGt)	Guitar	Distortion
1059	Resonator Guitar	Guitar	Acoustic
1060	Velo Growl	Bass	Acoustic
1061	Groove Acoustic AF	Bass	Acoustic
1062	Upright	Bass	Acoustic
1063	Prec Flat Wound	Bass	Electric
1064	Round Wound	Bass	Electric
1065	Active P	Bass	Electric
1066	Mid Range Finger	Bass	Electric
1067	Active TRB	Bass	Electric
1068	Passive BB AF1&2	Bass	Electric
1069	Vintage JB AF1&2	Bass	Electric
1070	Straight Finger AF	Bass	Electric
1071	JB Flat Wound AF	Bass	Electric
1072	Finger PickBass AF	Bass	Electric
1073	Prec Amped AF1	Bass	Electric
1074	Finger Bass Amp AF	Bass	Electric
1075	Fret Buzzy	Bass	Electric
1076	Small Cabinet	Bass	Electric
1077	Simple Pick	Bass	Electric
1078	Pick Open	Bass	Electric
1079	Pick Mute	Bass	Electric
1080	Pick Pull	Bass	Electric
1081	Straight Pick AF	Bass	Electric
1082	Velo Bass	Bass	Electric
1083	Slap Switch	Bass	Electric
1084	Fretless Dry	Bass	Electric
1085	Fretless Solo	Bass	Electric
1086	PBassFingerDist AF	Bass	Electric
1087	Fuzz Bass AF1	Bass	Electric
1088	Gnarly Bass	Bass	Electric
1089	BaCement	Bass	Electric
1090	Dist Tama Bass	Bass	Electric
1091	5th Fuzz Bass	Bass	Electric
1092	Chili Bass	Bass	Electric
1093	Big Cabinet	Bass	Electric
1094	Hybrid Bass 1	Bass	Electric
1095	Hybrid Bass 2	Bass	Electric
1096	3 VCOs	Bass	Synth
1097	Brain Bass AF1&2	Bass	Synth
1098	Lo Boy AF1&2	Bass	Synth
1099	Dark Bass	Bass	Synth
1100	Rn Bass RB	Bass	Synth
1101	Fundamental	Bass	Synth
1102	Fat Sine Resonance	Bass	Synth
1103	Moon Bass	Bass	Synth
1104	More Fatty	Bass	Synth
1105	Chill Out Bass AF1	Bass	Synth
1106	Growler	Bass	Synth
1107	Smacked	Bass	Synth
1108	booooooooooom	Bass	Synth
1109	Biting	Bass	Synth
1110	Boogie A Legato RB	Bass	Synth
1111	Uni Punch	Bass	Synth
1112	Noise Bass	Bass	Synth
1113	Single Oscillator	Bass	Synth
1114	Unison	Bass	Synth
1115	Long Spit AF2	Bass	Synth
1116	Big Bass	Bass	Synth
1117	Bass & Comp!	Bass	Synth
1118	Rave Blade	Bass	Synth
1119	Plastic Bass	Bass	Synth
1120	Funky Resonance RB	Bass	Synth

No.	Performance Name	Main Category	Sub Category
1121	Phat Three	Bass	Synth
1122	Needle Bass	Bass	Synth
1123	Acidd	Bass	Synth
1124	Boom Bass AF1	Bass	Synth
1125	West Coast	Bass	Synth
1126	Wazzo	Bass	Synth
1127	Fast PWM Bass	Bass	Synth
1128	Bass Pedal	Bass	Synth
1129	Oxide	Bass	Synth
1130	Bowngo	Bass	Synth
1131	Wide Synth Bass	Bass	Synth
1132	Dry Synth Bass	Bass	Synth
1133	Kick Bass Legato	Bass	Synth
1134	Keep Dancin'	Bass	Synth
1135	Velo Master	Bass	Synth
1136	Wah Bass	Bass	Synth
1137	Pulse Step AF1	Bass	Synth
1138	Phat Step	Bass	Synth
1139	Octave Analog	Bass	Synth
1140	Sync Bass	Bass	Synth
1141	Sync Big	Bass	Synth
1142	Puncher	Bass	Synth
1143	Dark Comp AF1&2	Bass	Synth
1144	Simple Bass	Bass	Synth
1145	Fat Sine	Bass	Synth
1146	Kompressor	Bass	Synth
1147	Dark Uni	Bass	Synth
1148	Fight Bass	Bass	Synth
1149	Byon Bass	Bass	Synth
1150	One Voice	Bass	Synth
1151	Pro-Attack AF1	Bass	Synth
1152	Bobby Bass	Bass	Synth
1153	Trance Bass	Bass	Synth
1154	Short SequenceBass	Bass	Synth
1155	Lately	Bass	Synth
1156	Faaat Pulse	Bass	Synth
1157	Short PWM Bass	Bass	Synth
1158	Hyper Velocity AF1	Bass	Synth
1159	Deep Point	Bass	Synth
1160	Pulse Stop	Bass	Synth
1161	Oh Bee Bass	Bass	Synth
1162	Booming Bass	Bass	Synth
1163	Army Bass	Bass	Synth
1164	Punchy Drone RB	Bass	Synth
1165	Dee Tune	Bass	Synth
1166	Chorus Pulse	Bass	Synth
1167	Sweeper	Bass	Synth
1168	Old House Organ	Bass	Synth
1169	Data Run	Bass	Synth
1170	Sharp 3o3	Bass	Synth
1171	Short 3o3 Saw	Bass	Synth
1172	Acid Fun	Bass	Synth
1173	Compu Bass	Bass	Synth
1174	Squeaker Bass	Bass	Synth
1175	Violin Solo 1	Strings	Solo
1176	Violin Solo 2 AF1	Strings	Solo
1177	Viola Solo 1	Strings	Solo
1178	Viola Solo 2 AF1	Strings	Solo
1179	Cello Solo	Strings	Solo
1180	Cello Duo AF1	Strings	Solo
1181	ContrabassSolo1	Strings	Solo
1182	ContrabassSolo2 AF	Strings	Solo
1183	Quartet	Strings	Ensemble
1184	Small Section	Strings	Ensemble
1185	Small Ensemble	Strings	Ensemble
1186	Almighty	Strings	Ensemble
1187	Medium Section	Strings	Ensemble
1188	Medium Hall	Strings	Ensemble
1189	MediumLargeSection	Strings	Ensemble
1190	Quick Bows	Strings	Ensemble

No.	Performance Name	Main Category	Sub Category
1191	Aggressive AF1	Strings	Ensemble
1192	Large Section	Strings	Ensemble
1193	Octave Ensemble	Strings	Ensemble
1194	Full Chamber	Strings	Ensemble
1195	Stryngs	Strings	Ensemble
1196	Dynamik Bow	Strings	Ensemble
1197	SymphonicPizzicato	Strings	Pizzicato
1198	Plucky Pizzicato	Strings	Pizzicato
1199	Octave Pizzes	Strings	Pizzicato
1200	Tremolo Strings 1	Strings	Ensemble
1201	Tremolo Strs Small	Strings	Ensemble
1202	Spicato Large	Strings	Pizzicato
1203	Disco AF1	Strings	Pizzicato
1204	Ens Mix	Strings	Ensemble
1205	Lush	Strings	Ensemble
1206	Back Ground	Strings	Ensemble
1207	Romantic	Strings	Ensemble
1208	Warm Back	Strings	Ensemble
1209	Stringy	Strings	Ensemble
1210	Big Strings	Strings	Ensemble
1211	PWM Strings	Strings	Synth
1212	Mourn Strings	Strings	Synth
1213	VP Soft	Strings	Synth
1214	PWM Simple	Strings	Synth
1215	Glassy Rezonant	Strings	Synth
1216	Superstrings	Strings	Synth
1217	Light Pad	Strings	Synth
1218	Noble Pad	Strings	Synth
1219	Warm Big	Strings	Ensemble
1220	Sentimental	Strings	Synth
1221	Analog Sweep	Strings	Synth
1222	Phase Strings	Strings	Synth
1223	Octave Strings	Strings	Synth
1224	JP Strings	Strings	Synth
1225	3 Oscillators Vin	Strings	Synth
1226	Silver Strings	Strings	Synth
1227	String Machine	Strings	Synth
1228	3 Octave Strings	Strings	Synth
1229	TranceIntroduction	Strings	Synth
1230	Mystic Trance	Strings	Synth
1231	F.Horn + Strings	Strings	Ensemble
1232	Wood Winds+Strings	Strings	Synth
1233	Electric Violin AF	Strings	Solo
1234	Tron Violin	Strings	Synth
1235	Tron Strings	Strings	Synth
1236	Tape Strings	Strings	Synth
1237	Orchestronic	Strings	Synth
1238	Vinyltron	Strings	Synth
1239	Analog Strings	Strings	Synth
1240	Analog Ensemble	Strings	Ensemble
1241	Pizz-o-matic	Strings	Pizzicato
1242	Ambient Pizza	Strings	Pizzicato
1243	Beauty Harp	Strings	Pizzicato
1244	Stereo Harp	Strings	Pizzicato
1245	Trumpet 1 AF1	Brass	Solo
1246	Tp Romantic Legato	Brass	Solo
1247	Classical Trumpet	Brass	Solo
1248	Baby Trumpet AF1	Brass	Solo
1249	Bright Trumpet AF1	Brass	Solo
1250	Tp SoftJazz Legato	Brass	Solo
1251	Legend Mute AF1	Brass	Solo
1252	Jazzy Flugel AF1	Brass	Solo
1253	Trumpet Section	Brass	Ensemble
1254	Trombone 1 AF1	Brass	Solo
1255	Blown Bone Legato	Brass	Solo
1256	Bright Trombone AF	Brass	Solo
1257	NewOrleansTrombone	Brass	Solo
1258	French Horn 1 AF1	Brass	Solo
1259	French Horn Solo	Brass	Solo
1260	BassTuba(Bb)	Brass	Solo

No.	Performance Name	Main Category	Sub Category
1261	Euphonium 1	Brass	Orchestra
1262	Bony Section	Brass	Ensemble
1263	FrenchHornSection1	Brass	Orchestra
1264	F.Horn + Trombone	Brass	Orchestra
1265	F.Hrn+Trombone+Trp	Brass	Orchestra
1266	Orchestra Brass	Brass	Orchestra
1267	Movie Horns	Brass	Orchestra
1268	Symphonic	Brass	Orchestra
1269	Smooth Brass	Brass	Orchestra
1270	Soft Brass mp-mf	Brass	Orchestra
1271	Dynamic Brass AF	Brass	Orchestra
1272	Accent mf-fall AF	Brass	Ensemble
1273	Small BrassSection	Brass	Ensemble
1274	MediumBrassSection	Brass	Ensemble
1275	Lots O' Brass	Brass	Ensemble
1276	Bright Section	Brass	Ensemble
1277	Power Section	Brass	Ensemble
1278	Shiny Brass	Brass	Ensemble
1279	Big Brass AF1&2	Brass	Ensemble
1280	Sforzando AF1&2	Brass	Ensemble
1281	Soft Brass & Sax	Brass	Ensemble
1282	Big Band	Brass	Ensemble
1283	Sax Big Band	Brass	Ensemble
1284	Velo Falls	Brass	Ensemble
1285	Hybrid Section	Brass	Synth
1286	Hybrid Bright	Brass	Synth
1287	Hybrid Brass Swell	Brass	Synth
1288	T Brass	Brass	Synth
1289	Lo-fi	Brass	Ensemble
1290	Quiet Brass	Brass	Synth
1291	Big Syn	Brass	Synth
1292	Thinth	Brass	Synth
1293	XP Brass Stereo	Brass	Synth
1294	Simple Saw Brass	Brass	Synth
1295	Brassy	Brass	Synth
1296	Kustom	Brass	Synth
1297	After 1984	Brass	Synth
1298	Finale	Brass	Synth
1299	Huge CS80	Brass	Synth
1300	CS-90	Brass	Synth
1301	Ob Soft	Brass	Synth
1302	Ob Horns	Brass	Synth
1303	Slow PWM Brass	Brass	Synth
1304	Soft 5th Brass	Brass	Synth
1305	Soprano Legato	Woodwind	Saxophone
1306	Soprano Soft AF1	Woodwind	Saxophone
1307	Alto Vib Legato	Woodwind	Saxophone
1308	Alto Legato	Woodwind	Saxophone
1309	Alto	Woodwind	Saxophone
1310	Tenor Dynamic AF1	Woodwind	Saxophone
1311	Tenor Soft Legato	Woodwind	Saxophone
1312	Velo Growl Legato	Woodwind	Saxophone
1313	Tenor Growl AF1	Woodwind	Saxophone
1314	Baritone	Woodwind	Saxophone
1315	Hip Bari	Woodwind	Saxophone
1316	Tenor Section	Woodwind	Saxophone
1317	Sax Octave Section	Woodwind	Saxophone
1318	Mixed Sax Section	Woodwind	Saxophone
1319	Flute Legato	Woodwind	Flute
1320	Sweet Flute AF1	Woodwind	Flute
1321	Wood Flute	Woodwind	Flute
1322	Oboe 1 AF1	Woodwind	Woodwind
1323	Sweet Oboe Legato	Woodwind	Woodwind
1324	Oboe Soft Legato	Woodwind	Woodwind
1325	Clarinet 1 AF1	Woodwind	Woodwind
1326	Jazzy Cla Legato	Woodwind	Woodwind
1327	Bassoon 1 AF1	Woodwind	Woodwind
1328	Irish Pipe Legato	Woodwind	Reed / Pipe
1329	2 Flutes	Woodwind	Flute
1330	Flute & Clari	Woodwind	Flute

No.	Performance Name	Main Category	Sub Category
1331	2 Oboes & Bassoon	Woodwind	Woodwind
1332	WoodWind Quartet	Woodwind	Woodwind
1333	Gentle Harp	Woodwind	Reed / Pipe
1334	Woody Harp	Woodwind	Reed / Pipe
1335	Bluz Distort	Woodwind	Reed / Pipe
1336	Campfire	Woodwind	Reed / Pipe
1337	Tron Flute	Woodwind	Flute
1338	Flootz	Woodwind	Flute
1339	Huge Lead	Syn Lead	Analog
1340	Bleep Lead AF2	Syn Lead	Analog
1341	Detuned Vintage	Syn Lead	Analog
1342	Space Lead	Syn Lead	Analog
1343	Dual Square Lead	Syn Lead	Analog
1344	Vintage Sync	Syn Lead	Analog
1345	Dirty Hook	Syn Lead	Analog
1346	Nu Mini	Syn Lead	Analog
1347	ProgressiveRk Lead	Syn Lead	Analog
1348	Lucky	Syn Lead	Analog
1349	Opening	Syn Lead	Analog
1350	Rap Lead 1	Syn Lead	Analog
1351	Mini Soft	Syn Lead	Analog
1352	Feeling	Syn Lead	Analog
1353	Early Lead	Syn Lead	Analog
1354	Funky Pulse	Syn Lead	Digital
1355	Mr. Finger	Syn Lead	Analog
1356	Singleline 1	Syn Lead	Analog
1357	Soft RnB	Syn Lead	Analog
1358	Wind Synth	Syn Lead	Analog
1359	Broken Sine RB	Syn Lead	Analog
1360	Duck Lead	Syn Lead	Analog
1361	In da Night	Syn Lead	Analog
1362	Mayday MW	Syn Lead	Analog
1363	On D Line	Syn Lead	Analog
1364	Early Soloist	Syn Lead	Analog
1365	Heterodyne	Syn Lead	Analog
1366	Classic 5th	Syn Lead	Analog
1367	Vintage Saw	Syn Lead	Analog
1368	Mini Three	Syn Lead	Digital
1369	Phat Dino	Syn Lead	Digital
1370	Dynamic Mini	Syn Lead	Digital
1371	PWM Lead	Syn Lead	Digital
1372	Pulse Wound	Syn Lead	Digital
1373	Think Sync	Syn Lead	Digital
1374	Punch Lead	Syn Lead	Digital
1375	Bright Saw	Syn Lead	Digital
1376	Trojan	Syn Lead	Digital
1377	Wood Panel	Syn Lead	Digital
1378	Push Ahead	Syn Lead	Digital
1379	Eight	Syn Lead	Digital
1380	Sync Power	Syn Lead	Digital
1381	Glisten Lead	Syn Lead	Digital
1382	Big Drone	Syn Lead	Digital
1383	Screameemy	Syn Lead	Digital
1384	Flange Filter	Syn Lead	Digital
1385	Sutra	Syn Lead	Digital
1386	Free LFO	Syn Lead	Digital
1387	Rap Lead 2	Syn Lead	Digital
1388	Space Power Lead	Syn Lead	Digital
1389	Nyquist	Syn Lead	Digital
1390	Digimetal	Syn Lead	Digital
1391	Saw destroy	Syn Lead	Digital
1392	Vinalog saw	Syn Lead	Digital
1393	Mady SQU	Syn Lead	Digital
1394	Low Undulation	Syn Lead	Digital
1395	Impact	Syn Lead	Hip Hop
1396	Talk Mod	Syn Lead	Hip Hop
1397	Digital Gangsta	Syn Lead	Hip Hop
1398	Plastic Squeeze	Syn Lead	Hip Hop
1399	Pinz Lead	Syn Lead	Hip Hop
1400	Dancy Saw Lead	Syn Lead	Dance

No.	Performance Name	Main Category	Sub Category
1401	Buzz Around	Syn Lead	Dance
1402	Xtreme Wheel	Syn Lead	Dance
1403	Supertrance	Syn Lead	Dance
1404	Poly Hook	Syn Lead	Dance
1405	HPF Dance	Syn Lead	Dance
1406	Tekk Glide	Syn Lead	Dance
1407	Growl Tekk	Syn Lead	Dance
1408	Plucked Chordz	Syn Lead	Dance
1409	Chordz	Syn Lead	Dance
1410	Cool Body	Syn Lead	Dance
1411	Twist Sync	Syn Lead	Dance
1412	TEKIE	Syn Lead	Dance
1413	Sonix	Syn Lead	Dance
1414	Big SkidHookLead 1	Syn Lead	Dance
1415	Big SkidHookLead 2	Syn Lead	Dance
1416	Porta Queen	Syn Lead	Electronic
1417	Vicious Dogs	Syn Lead	Digital
1418	Saw Pad	Pad/Choir	Analog
1419	Dark ModulationPad	Pad/Choir	Analog
1420	Dark Light	Pad/Choir	Warm
1421	Ambient Synth Pad	Pad/Choir	Analog
1422	5th Lite	Pad/Choir	Analog
1423	Smooth BPF Sweep	Pad/Choir	Analog
1424	High Wire	Pad/Choir	Analog
1425	Trance MW	Pad/Choir	Analog
1426	Xtreme Sweep	Pad/Choir	Analog
1427	Nu Warm Pad	Pad/Choir	Warm
1428	5th Atmosphere	Pad/Choir	Warm
1429	Dim	Pad/Choir	Warm
1430	Simple Air	Pad/Choir	Warm
1431	Nature Sine	Pad/Choir	Warm
1432	Analog	Pad/Choir	Warm
1433	Perc Pad	Pad/Choir	Warm
1434	Dark Atmo Pad	Pad/Choir	Warm
1435	Dark Organ Pad	Pad/Choir	Warm
1436	Soft Brassy	Pad/Choir	Warm
1437	Road to Nowhere	Pad/Choir	Warm
1438	Sweep Strings	Pad/Choir	Warm
1439	Brass Motion Pad	Pad/Choir	Warm
1440	Luminous	Pad/Choir	Warm
1441	Mother Ship	Pad/Choir	Choir
1442	Warm Backing Pad	Pad/Choir	Warm
1443	Feather	Pad/Choir	Warm
1444	Pan Sphere	Pad/Choir	Warm
1445	Square	Pad/Choir	Analog
1446	Shaper	Pad/Choir	Bright
1447	Early Digital	Pad/Choir	Warm
1448	Dramana	Pad/Choir	Bright
1449	Dream Shift	Pad/Choir	Bright
1450	Remote Space	Pad/Choir	Warm
1451	Fathoms	Pad/Choir	Warm
1452	SY22 2007	Pad/Choir	Warm
1453	Mother Earth	Pad/Choir	Warm
1454	Landing Pad	Pad/Choir	Warm
1455	The Breath	Pad/Choir	Bright
1456	Humanity	Pad/Choir	Warm
1457	Vowel Pad	Pad/Choir	Choir
1458	Feather Pad	Pad/Choir	Bright
1459	Slow Attack Pad	Pad/Choir	Bright
1460	Hi Brite	Pad/Choir	Bright
1461	Pad & Syn	Pad/Choir	Bright
1462	Cosmic Swell Pad	Pad/Choir	Bright
1463	Sweet Flange	Pad/Choir	Bright
1464	Waterfall	Pad/Choir	Bright
1465	Phase Pad	Pad/Choir	Bright
1466	Pure Synth	Pad/Choir	Bright
1467	Pearls	Pad/Choir	Bright
1468	Flange Wall	Pad/Choir	Bright
1469	Tornado	Pad/Choir	Bright
1470	Ice Rink	Pad/Choir	Bright

No.	Performance Name	Main Category	Sub Category
1471	Turbulence	Pad/Choir	Bright
1472	Bell Pad	Pad/Choir	Bright
1473	Paradise	Pad/Choir	Bright
1474	Yellow River	Pad/Choir	Bright
1475	Love Me	Pad/Choir	Bright
1476	Frozen Pad	Pad/Choir	Bright
1477	Pensive	Pad/Choir	Warm
1478	Space Vocals	Pad/Choir	Choir
1479	Haah Pad	Pad/Choir	Choir
1480	Oooh Pad	Pad/Choir	Choir
1481	Back in Itopian	Pad/Choir	Choir
1482	Strings & Choir	Pad/Choir	Choir
1483	Angel Eyes	Pad/Choir	Choir
1484	Glass Choir	Pad/Choir	Choir
1485	Nativity	Pad/Choir	Choir
1486	Seraphim	Pad/Choir	Choir
1487	Analog Shine	Pad/Choir	Analog
1488	Cosmic Gate	Pad/Choir	Bright
1489	CatchingWildHorses	Pad/Choir	Bright
1490	High Pass Gate	Pad/Choir	Bright
1491	RhythmicFilterPad1	Pad/Choir	Warm
1492	RhythmicFilterPad2	Pad/Choir	Bright
1493	P5 Resonance Comp	Syn Comp	Analog
1494	P5 Analog Punch	Syn Comp	Analog
1495	Cool Trance	Syn Comp	Analog
1496	>Attack<	Syn Comp	Analog
1497	Club Finger	Syn Comp	Analog
1498	Wobbly RB	Syn Comp	Analog
1499	Ana Dayz	Syn Comp	Analog
1500	Airy Nylon	Syn Comp	Analog
1501	Progressive Attack	Syn Comp	Analog
1502	Oracle	Syn Comp	Analog
1503	Big Comp	Syn Comp	Digital
1504	Rezz Punch	Syn Comp	Digital
1505	Resonant Clavi	Syn Comp	Digital
1506	Straight RB	Syn Comp	Digital
1507	Psych Noise	Syn Comp	Digital
1508	SquiffyMisbehaving	Syn Comp	Digital
1509	Lektro Codes	Syn Comp	Digital
1510	Hard FM Keys	Syn Comp	Digital
1511	W Phaser	Syn Comp	Digital
1512	DPCM Attack	Syn Comp	Digital
1513	Talk	Syn Comp	Digital
1514	Digy_SEQ	Syn Comp	Digital
1515	Nerve Nasty	Syn Comp	Analog
1516	Ring_Zplus	Syn Comp	Digital
1517	Trance Attack	Syn Comp	Digital
1518	Tekno Attack AF1&2	Syn Comp	Digital
1519	PWM Percussion	Syn Comp	Digital
1520	Stabby	Syn Comp	Digital
1521	Detroit Stab	Syn Comp	Digital
1522	Corrado	Syn Comp	Digital
1523	Syntheticque	Syn Comp	Digital
1524	Noiz Rezz	Syn Comp	Digital
1525	Tuxedo	Syn Comp	Digital
1526	Queens	Syn Comp	Digital
1527	Hip Voice	Syn Comp	Digital
1528	GX1	Syn Comp	Decay
1529	Night Watch	Syn Comp	Decay
1530	Pluck Bells	Syn Comp	Decay
1531	Power Dance Chords	Syn Comp	Hook
1532	Hyper Trance	Syn Comp	Digital
1533	Cosmic Psyche	Syn Comp	Digital
1534	Chillin' Chords	Syn Comp	Hook
1535	Dirty Chordz	Syn Comp	Hook
1536	Wild Horses	Syn Comp	Electronic
1537	Sixpack AF1&2	Syn Comp	Electronic
1538	Percussive Chords	Syn Comp	Electronic
1539	Chordmaster	Syn Comp	Electronic
1540	In the Mirror	Syn Comp	Electronic

No.	Performance Name	Main Category	Sub Category
1541	Come together!	Syn Comp	Electronic
1542	Happy Hour	Syn Comp	Electronic
1543	Recycling	Syn Comp	Electronic
1544	Digital Dreaming	Syn Comp	Electronic
1545	Carpenter's Wife	Syn Comp	Electronic
1546	Electronic Games	Syn Comp	Electronic
1547	Dancing Waves	Syn Comp	Electronic
1548	Hit Factory	Syn Comp	Electronic
1549	Freaky Loop	Syn Comp	Electronic
1550	Mr. Wah!	Syn Comp	Electronic
1551	Chill Comp 1	Syn Comp	Jazz/World
1552	Chill Comp 2	Syn Comp	Jazz/World
1553	Kalimboidal	Syn Comp	Jazz/World
1554	Bippus	Syn Comp	Electronic
1555	Virtuoso Sequencia	Syn Comp	Electronic
1556	Fat Saw Arpeggio	Syn Comp	Electronic
1557	Trancious Line	Syn Comp	Electronic
1558	Metal Plate	Syn Comp	Electronic
1559	Fifth Dancer	Syn Comp	Electronic
1560	PercussiveSequence	Syn Comp	Electronic
1561	Simply Faaat	Syn Comp	Electronic
1562	Bright Dance	Syn Comp	Electronic
1563	Quadro Tune	Syn Comp	Electronic
1564	Champ	Syn Comp	Electronic
1565	Men In Yellow	Sound FX	Moving
1566	Metamorphosis	Sound FX	Moving
1567	Perplex	Sound FX	Moving
1568	Outer Planet	Sound FX	Moving
1569	Industrial	Sound FX	Moving
1570	Space Walking	Sound FX	Moving
1571	Scraper	Sound FX	Moving
1572	SE_02 <Zero Two>	Sound FX	Moving
1573	Talking Machines	Sound FX	Moving
1574	Tobi Mage	Sound FX	Moving
1575	Bitzz MW	Sound FX	Moving
1576	Thexism	Sound FX	Moving
1577	In My Head	Sound FX	Moving
1578	Toda	Sound FX	Ambient
1579	Water Tank	Sound FX	Ambient
1580	Auto Trapeze	Sound FX	Ambient
1581	Harpist'sNightmare	Sound FX	Ambient
1582	Find Newgt!	Sound FX	Ambient
1583	Nile River	Sound FX	Nature
1584	New Age Atmo	Sound FX	Nature
1585	Wind Blows	Sound FX	Nature
1586	Fire!	Sound FX	Nature
1587	Scratching Machine	Sound FX	Sci-Fi
1588	Goa Psyche	Sound FX	Sci-Fi
1589	WaitForBadWeather	Sound FX	Sci-Fi
1590	Reverse The Audio	Sound FX	Sci-Fi
1591	Radio Static	Sound FX	Sci-Fi
1592	Modifier X	Sound FX	Sci-Fi
1593	Surveillance	Sound FX	Sci-Fi
1594	Noise FX	Sound FX	Sci-Fi
1595	Sample&HoldVintage	Sound FX	Sci-Fi
1596	Lazerzz	Sound FX	Sci-Fi
1597	uhohhrr	Sound FX	Sci-Fi
1598	On The Fritz	Sound FX	Sci-Fi
1599	Scratch Thing MW	Sound FX	Moving
1600	Trash Can Lid Band	Sound FX	Moving
1601	Piston Engine	Sound FX	Moving
1602	Waka Waka Noize	Sound FX	Moving
1603	Argentina	Sound FX	Moving
1604	Gate of Eden	Musical FX	Moving
1605	Wave Journey	Musical FX	Moving
1606	Whispering Ghosts	Musical FX	Moving
1607	NightrainToMunich	Musical FX	Moving
1608	Morning Dew	Musical FX	Moving
1609	Calling Mr. Reso	Musical FX	Moving
1610	2 SwitchesToHeaven	Musical FX	Moving

No.	Performance Name	Main Category	Sub Category
1611	Cell Division	Musical FX	Moving
1612	Jumping Needle	Musical FX	Moving
1613	SEKAI-ISAN	Musical FX	Moving
1614	Setsunai AF2	Musical FX	Moving
1615	Week End	Musical FX	Moving
1616	Dragonfly	Sound FX	Sci-Fi
1617	TIRIPAD	Musical FX	Moving
1618	Cluster	Musical FX	Moving
1619	Xtreme Rezz	Musical FX	Moving
1620	Bit Space	Musical FX	Moving
1621	My Reality	Musical FX	Moving
1622	Waterproof	Musical FX	Moving
1623	Magnetics	Musical FX	Moving
1624	Sand	Musical FX	Moving
1625	Felicity	Musical FX	Moving
1626	Vibrancy	Musical FX	Moving
1627	Metalfake	Musical FX	Moving
1628	Radio Venus	Musical FX	Moving
1629	Elec Blue	Musical FX	Moving
1630	Chyo Ethno	Musical FX	Moving
1631	Metal Shaper	Musical FX	Moving
1632	Calculator	Musical FX	Moving
1633	konjoh BEAM	Musical FX	Moving
1634	Blizzard	Musical FX	Ambient
1635	SINGING BOWL	Musical FX	Ambient
1636	Vektris	Musical FX	Ambient
1637	Metalvox Pad	Musical FX	Ambient
1638	Refraction	Musical FX	Ambient
1639	Philanger	Musical FX	Ambient
1640	Slippery Ambience	Musical FX	Moving
1641	Ellipsotron	Musical FX	Moving
1642	Envelope	Musical FX	Moving
1643	Whatsis	Musical FX	Ambient
1644	Pearl Collection	Musical FX	Ambient
1645	Four Dimensions	Musical FX	Ambient
1646	Hallucination	Musical FX	Ambient
1647	Arctic Sequence	Musical FX	Ambient
1648	Drifting	Musical FX	Ambient
1649	Electraid	Musical FX	Ambient
1650	Bed Time Story	Musical FX	Ambient
1651	Clearing	Musical FX	Sweep
1652	Long HiPa	Musical FX	Sweep
1653	Quad Swell	Musical FX	Sweep
1654	New Stab	Musical FX	Hit
1655	Vinyl Hit	Musical FX	Hit
1656	Hit Me	Musical FX	Hit
1657	Ambient Bite	Musical FX	Hit
1658	Green Valley	Musical FX	Ambient
1659	Everlasting Glory	Musical FX	Ambient
1660	Thinking of You	Musical FX	Ambient
1661	FestivalOfHarmony	Musical FX	Ambient
1662	Paris at Night	Musical FX	Ambient
1663	On my Way to UK	Musical FX	Ambient
1664	Chillin' Ibiza	Musical FX	Ambient
1665	Heavens Door	Musical FX	Ambient
1666	Cocktail	Musical FX	Ambient
1667	Vanilla	Musical FX	Ambient
1668	Ibiza Groove	Musical FX	Ambient
1669	Nylon Chill	Musical FX	Ambient
1670	Xtreme Harp	Musical FX	Ambient
1671	TrancingInTheRain	Musical FX	Ambient
1672	Gated Detune	Musical FX	Moving
1673	Gated Choir	Musical FX	Moving
1674	Exotic	Musical FX	Moving
1675	Syncscrapper	Musical FX	Moving
1676	Ethnotic	Musical FX	Moving
1677	Com Sat	Musical FX	Moving
1678	Investikator	Musical FX	Moving
1679	Monkey Bars	Musical FX	Moving
1680	Chilltrancer	Musical FX	Moving

No.	Performance Name	Main Category	Sub Category
1681	Random Beatz	Musical FX	Moving
1682	Electro Hood	Musical FX	Moving
1683	My Subwoofers	Musical FX	Moving
1684	Mister Sinister	Musical FX	Moving
1685	Polyrhythm	Musical FX	Moving
1686	Blood Flow	Musical FX	Moving
1687	On The Verge	Musical FX	Moving
1688	Droid	Musical FX	Moving
1689	Worker Ant	Musical FX	Moving
1690	Chopp Lingo	Musical FX	Moving
1691	Vinyl Beatnik	Musical FX	Moving
1692	Drop Zone ARP	Musical FX	Moving
1693	Particle	Musical FX	Moving
1694	Simple Arp	Musical FX	Moving
1695	Cyber Cycle	Musical FX	Moving
1696	Bollog Puls	Musical FX	Moving
1697	Octopus	Musical FX	Moving
1698	Electronic Beatz	Musical FX	Moving
1699	Dreamin' of You	Musical FX	Moving
1700	Brothers & Sisters	Musical FX	Moving
1701	Pizza No.1	Musical FX	Moving
1702	Electronix	Musical FX	Moving
1703	Tekk Now	Musical FX	Moving
1704	Hollow Sequence	Musical FX	Ambient
1705	Icicle	Musical FX	Ambient
1706	Jegog	Musical FX	Moving
1707	Octo Strobe 1	Musical FX	Moving
1708	Octo Strobe 2	Musical FX	Moving
1709	Random Waves	Musical FX	Moving
1710	Semar	Musical FX	Moving
1711	TrailingHeadlights	Musical FX	Moving
1712	Dream Winds	Musical FX	Moving
1713	Kemence	Ethnic	Bowed
1714	Kemen Wet	Ethnic	Bowed
1715	Yayli	Ethnic	Bowed
1716	Kawala	Ethnic	Bowed
1717	Santur	Ethnic	Struck
1718	Baglama	Ethnic	Plucked
1719	Kotoun	Ethnic	Plucked
1720	Kanun	Ethnic	Plucked
1721	Bouzuki	Ethnic	Plucked
1722	Oud Tremolo Vel	Ethnic	Plucked
1723	Saz Feeze	Ethnic	Plucked
1724	Where Am I?	Ethnic	Plucked
1725	Sakura	Ethnic	Plucked
1726	Nomad	Ethnic	Plucked
1727	Pluk-o-dy	Ethnic	Plucked
1728	Tambura	Ethnic	Plucked
1729	Sitar MW	Ethnic	Plucked
1730	Tabla Zone	Ethnic	Struck
1731	Udu	Ethnic	Struck
1732	Djembe	Ethnic	Struck
1733	Dhol	Ethnic	Struck
1734	Khol	Ethnic	Struck
1735	Ney	Ethnic	Blown
1736	Zurna	Ethnic	Blown
1737	Pungi	Ethnic	Blown
1738	Shehnai 1	Ethnic	Blown
1739	Didgeridoo	Ethnic	Blown
1740	Snake Charmer	Ethnic	Blown
1741	Mythic Flute	Ethnic	Blown
1742	Ethnology	Ethnic	Jazz/World
1743	Oztralian	Ethnic	Jazz/World
1744	8Z Destruct	Drum / Perc	Drums
1745	8Z Jarrin	Drum / Perc	Drums
1746	8Z Romps	Drum / Perc	Drums
1747	8Z Glitch	Drum / Perc	Drums
1748	8Z Oxidized	Drum / Perc	Drums
1749	8Z D&B Machine	Drum / Perc	Drums
1750	8Z Down Tempo	Drum / Perc	Drums

No.	Performance Name	Main Category	Sub Category
1751	8Z Early Lo-Fi	Drum / Perc	Drums
1752	8Z Noize Xpress	Drum / Perc	Drums
1753	8Z Trance Basics 1	Drum / Perc	Drums
1754	8Z Reverse Beatz	Drum / Perc	Drums
1755	8Z Crush Dance	Drum / Perc	Drums
1756	8Z Heavy Hearts	Drum / Perc	Drums
1757	8Z Chilly Breakz	Drum / Perc	Drums
1758	8Z Gated Beatz	Drum / Perc	Drums
1759	8Z Hip Hop Shakers	Drum / Perc	Drums
1760	8Z Blip Hop	Drum / Perc	Drums
1761	8Z Nasty Glitch	Drum / Perc	Drums
1762	8Z Scratch	Drum / Perc	Drums
1763	8Z Tod	Drum / Perc	Drums
1764	8Z Psychedelic 1	Drum / Perc	Drums
1765	8Z Psychedelic 2	Drum / Perc	Drums
1766	8Z Dub Element	Drum / Perc	Drums
1767	Mega Nylon	Guitar	Acoustic
1768	Mega Steel	Guitar	Acoustic
1769	Mega 12 Steel	Guitar	Acoustic
1770	Mega 60s Clean	Guitar	Electric Clean
1771	Mega60sChorusCombo	Guitar	Electric Clean
1772	Mega 60s Tremolo	Guitar	Electric Clean
1773	Mega 60s BluesTone	Guitar	Electric Clean
1774	Mega 60s Phaser	Guitar	Electric Clean
1775	Mega 60s Tube Tone	Guitar	Distortion
1776	Mega 60sDistStack	Guitar	Distortion
1777	Mega 60sRoadHouse	Guitar	Distortion
1778	Mega 60sSmallBlues	Guitar	Electric Clean
1779	Mega 60s Pedal Wah	Guitar	Distortion
1780	Mega 60s VCM T.Wah	Guitar	Distortion
1781	Mega 60sT.Wah&Dist	Guitar	Distortion
1782	Mega 60sJetFlanger	Guitar	Distortion
1783	Mega 1coil Clean	Guitar	Electric Clean
1784	Mega 1coil Chorus	Guitar	Electric Clean
1785	Mega 1coil Tremolo	Guitar	Electric Clean
1786	Mega1coilBluesTone	Guitar	Electric Clean
1787	Mega 1coil Phaser	Guitar	Electric Clean
1788	Mega 1coilTubeTone	Guitar	Electric Clean
1789	Mega 1coilTubeAmp1	Guitar	Distortion
1790	Mega 1coilTubeAmp2	Guitar	Distortion
1791	Mega1coilRoadhouse	Guitar	Distortion
1792	Mega 1coilVCM T.Wah	Guitar	Electric Clean
1793	Mega 60sCleanDelay	Guitar	Electric Clean
1794	Mega 60s SlapClean	Guitar	Electric Clean
1795	Mega 60s Slap Dist	Guitar	Electric Clean
1796	Mega1coilSlapClean	Guitar	Electric Clean
1797	Mega 1coilSlapDist	Guitar	Distortion
1798	Mega 1coilSlpPdWah	Guitar	Electric Clean
1799	MegaOvdrDistortion	Guitar	Distortion
1800	Mega Ovdr Fuzz	Guitar	Distortion
1801	Mega Acoustic Bass	Bass	Acoustic
1802	Mega Finger+Harmo	Bass	Electric
1803	Mega Fretless Bass	Bass	Electric
1804	Mega PickOpenAmped	Bass	Electric
1805	Mega PickMuteAmped	Bass	Electric
1806	Mega Slap Bass	Bass	Electric
1807	Mega Finger+Slap	Bass	Electric
1808	MegaFinger+PullAmp	Bass	Electric
1809	Mega Pick OpenMute	Bass	Electric
1810	Mega Pick OpMtDark	Bass	Electric
1811	Vocoder with Delay	Pad/Choir	Choir
1812	Funky Vocoder	Pad/Choir	Choir
1813	Vocoder Pad 1	Pad/Choir	Choir
1814	Vocoder Pad 2	Pad/Choir	Choir
1815	Concert GrandPiano	Piano	Acoustic
1816	Rock Brite Piano	Piano	Modern
1817	CP 2007	Piano	Vintage
1818	Honkytonk	Piano	Vintage
1819	E.Piano 1	Keyboard	Electric Piano
1820	E. Piano 2	Keyboard	FM Piano

No.	Performance Name	Main Category	Sub Category
1821	Harpichord	Keyboard	Clavi
1822	Brite Clavi	Keyboard	Clavi
1823	Celesta	Chromatic Perc	Mallet
1824	Glocken	Chromatic Perc	Mallet
1825	Music Box	Chromatic Perc	Bell
1826	Vibes	Chromatic Perc	Mallet
1827	Marimba	Chromatic Perc	Mallet
1828	Xylophone	Chromatic Perc	Mallet
1829	Tubular Bell 1	Chromatic Perc	Bell
1830	Dulcimer	Chromatic Perc	Pitched Drum
1831	Draw Organ	Organ	Tone Wheel
1832	Percussive Organ	Organ	Tone Wheel
1833	Rock Organ 1	Organ	Tone Wheel
1834	Church Organ	Organ	Pipe
1835	Reed Organ	Organ	Pipe
1836	Accordion	Organ	Pipe
1837	Harmonica	Woodwind	Reed / Pipe
1838	Tango Accordion 1	Organ	Pipe
1839	Nylon Guitar	Guitar	Acoustic
1840	Steel Guitar	Guitar	Acoustic
1841	Jazz Guitar	Guitar	Electric Clean
1842	Clean Guitar	Guitar	Electric Clean
1843	Mute Guitar	Guitar	Electric Clean
1844	Overdrive Guitar	Guitar	Distortion
1845	Distortion Guitar	Guitar	Distortion
1846	Guitar Harmonics	Guitar	Distortion
1847	Acoustic Bass	Bass	Acoustic
1848	Finger Bass	Bass	Electric
1849	Pick Bass	Bass	Electric
1850	Fretless Bass	Bass	Electric
1851	Slap Bass 1	Bass	Electric
1852	Slap Bass 2 Vel	Bass	Electric
1853	Synth Bass 1	Bass	Synth
1854	Synth Bass 2	Bass	Synth
1855	Violin	Strings	Solo
1856	Viola	Strings	Solo
1857	Cello	Strings	Solo
1858	Contrabass	Strings	Solo
1859	Tremolo Strings 2	Strings	Ensemble
1860	Pizzicato	Strings	Pizzicato
1861	Harp	Strings	Pizzicato
1862	Timpani + Cymbal	Chromatic Perc	Pitched Drum
1863	Strings Section 1	Strings	Ensemble
1864	Strings Section 2	Strings	Ensemble
1865	Synth Strings 1	Strings	Synth
1866	Synth Strings 2	Strings	Synth
1867	Aah Choir	Pad/Choir	Choir
1868	Ooh Choir	Pad/Choir	Choir
1869	Syn Voice	Pad/Choir	Choir
1870	Orchestra Hit	Musical FX	Hit
1871	Trumpet 2	Brass	Solo
1872	Trombone 2	Brass	Solo
1873	Tuba	Brass	Solo
1874	Mute Trumpet	Brass	Solo
1875	French Horns	Brass	Orchestra
1876	Brass Section	Brass	Ensemble
1877	Synth Brass 1	Brass	Synth
1878	Synth Brass 2	Brass	Synth
1879	Soprano Sax	Woodwind	Saxophone
1880	Alto Sax	Woodwind	Saxophone
1881	Tenor Sax	Woodwind	Saxophone
1882	Baritone Sax	Woodwind	Saxophone
1883	Oboe 2	Woodwind	Woodwind
1884	English Horn	Woodwind	Woodwind
1885	Bassoon 2	Woodwind	Woodwind
1886	Clarinet 2	Woodwind	Woodwind
1887	Piccolo 1	Woodwind	Flute
1888	Flute	Woodwind	Flute
1889	Recorder	Woodwind	Woodwind
1890	Panflute	Woodwind	Flute

No.	Performance Name	Main Category	Sub Category
1891	Bottle	Woodwind	Flute
1892	Shakuhachi	Woodwind	Flute
1893	Whistle	Woodwind	Woodwind
1894	Ocarina	Woodwind	Woodwind
1895	Square Lead	Syn Lead	Analog
1896	Saw Lead	Syn Lead	Analog
1897	Calliope Lead	Syn Lead	Analog
1898	Chiff Lead	Syn Lead	Analog
1899	Charan Lead	Syn Lead	Digital
1900	Voice Lead	Syn Lead	Analog
1901	Fifth Lead	Syn Lead	Analog
1902	Bass & Lead	Syn Lead	Analog
1903	New Age Pad	Pad/Choir	Bright
1904	Warm Pad	Pad/Choir	Warm
1905	Poly Synth Pad	Pad/Choir	Analog
1906	Choir Pad	Pad/Choir	Choir
1907	Bowed Pad	Pad/Choir	Warm
1908	Metal Pad	Pad/Choir	Bright
1909	Halo Pad	Pad/Choir	Bright
1910	Sweep Pad	Pad/Choir	Bright
1911	Rain Pad	Musical FX	Moving
1912	Sound Track	Pad/Choir	Bright
1913	Crystal	Chromatic Perc	Bell
1914	Atmosphere	Pad/Choir	Warm
1915	Brightness	Syn Comp	Digital
1916	Goblin	Musical FX	Sweep
1917	Echoes	Musical FX	Moving
1918	Sci-Fi	Pad/Choir	Bright
1919	Sitar 1	Ethnic	Plucked
1920	Banjo 1	Ethnic	Plucked
1921	Shamisen	Ethnic	Plucked
1922	Koto	Ethnic	Plucked
1923	Kalimba	Chromatic Perc	Mallet
1924	Bagpipe	Woodwind	Reed / Pipe
1925	Fiddle	Ethnic	Bowed
1926	Shehnai 2	Woodwind	Woodwind
1927	Tinkle Bell	Chromatic Perc	Bell
1928	Agogo	Drum / Perc	Percussion
1929	Steel Drum	Chromatic Perc	Pitched Drum
1930	Woodblock	Drum / Perc	Percussion
1931	Taiko Drum	Drum / Perc	Percussion
1932	Melodic Tom	Drum / Perc	Drums
1933	Synth Drum	Drum / Perc	Drums
1934	Reverse Cymbal	Sound FX	Moving
1935	Fret Noise	Sound FX	Nature
1936	Breath Noiz	Sound FX	Nature
1937	Seashore	Sound FX	Nature
1938	Tweet	Sound FX	Nature
1939	Telephone	Sound FX	Nature
1940	Helicopter	Sound FX	Nature
1941	Applause	Sound FX	Nature
1942	Gunshot	Sound FX	Nature
1943	Natural Grand S6	Piano	Acoustic
1944	Piano Rock S6	Piano	Modern
1945	Woody Piano S6	Piano	Vintage
1946	Intimate S6	Piano	Vintage
1947	Clavi Bril Treble	Keyboard	Clavi
1948	Clavi Amped	Keyboard	Clavi
1949	Clavi Phaser	Keyboard	Clavi
1950	Clavi Touch Wah	Keyboard	Clavi
1951	Clavi PdWah FC2&MW	Keyboard	Clavi
1952	NaturalHarpichord	Keyboard	Clavi
1953	Octave Harpichord	Keyboard	Clavi
1954	Vx Full Bars	Organ	Combo
1955	Vx Dark Bars	Organ	Combo
1956	Fr All Tabs	Organ	Combo
1957	Fr Bright Boost	Organ	Combo
1958	Fr String Tabs	Organ	Combo
1959	Vx Full Bars Amped	Organ	Combo
1960	Vx Surf Organ	Organ	Combo

No.	Performance Name	Main Category	Sub Category
1961	Fr Raspy Tabs	Organ	Combo
1962	Master Accordion	Organ	Pipe
1963	French Musette	Organ	Pipe
1964	Cassotto	Organ	Pipe
1965	Tango Accordion 2	Organ	Pipe
1966	Vibraphone	Chromatic Perc	Mallet
1967	Vibraphone Soft	Chromatic Perc	Mallet
1968	Tubular Bell 2	Chromatic Perc	Bell
1969	RealTimpani AF Mfl	Chromatic Perc	Mallet
1970	1coil Clean AF1&2	Guitar	Electric Clean
1971	1coil Amped Vel	Guitar	Electric Clean
1972	Vintage1coilChorus	Guitar	Electric Clean
1973	Surfin' 60s 1coil	Guitar	Electric Clean
1974	Breakback Mountain	Guitar	Distortion
1975	Grunged Up	Guitar	Distortion
1976	Jazz Clean AF1&2	Guitar	Electric Clean
1977	Arched Top	Guitar	Electric Clean
1978	Jazz Blues	Guitar	Electric Clean
1979	Round Wound Finger	Bass	Electric
1980	Tube Finger Bass	Bass	Electric
1981	Slightly Grunged	Bass	Electric
1982	Prec Pick	Bass	Electric
1983	Pick Amp	Bass	Electric
1984	Universal AF1&2	Bass	Synth
1985	Analog Bullet Bass	Bass	Synth
1986	Analog Perc Bass	Bass	Synth
1987	Analog Step Bass	Bass	Synth
1988	Short Buzz AF1&2	Bass	Rock/Pop
1989	Bass Machine AF1	Bass	Electronic
1990	Deep Ramp AF1&2	Bass	Electronic
1991	Section Strings 1	Strings	Ensemble
1992	Section Strings 2	Strings	Ensemble
1993	Section Strings 3	Strings	Ensemble
1994	Section Strings 4	Strings	Ensemble
1995	Tremolo Section	Strings	Ensemble
1996	Pizzicato Vel	Strings	Pizzicato
1997	Orchestra Harp	Strings	Pizzicato
1998	Harp Ambient	Strings	Pizzicato
1999	Gleaming Pad AF1&2	Strings	Synth
2000	Fat PWM Synth Vel	Strings	Synth
2001	VintagePolyStrings	Strings	Synth
2002	SoftTrumpetLegato	Brass	Solo
2003	Trumpet Vibrato	Brass	Solo
2004	Trumpet Shake Vel	Brass	Solo
2005	FrenchHornSection2	Brass	Orchestra
2006	Flugelhorn	Brass	Solo
2007	Jazz Brass Section	Brass	Ensemble
2008	Ob Syncomp	Brass	Synth
2009	Tacky Brass AF1&2	Brass	Synth
2010	Mellow Soprano	Woodwind	Saxophone
2011	Alto Accent Legato	Woodwind	Saxophone
2012	Tenor Max	Woodwind	Saxophone
2013	SoftTenorSaxLegato	Woodwind	Saxophone
2014	Piccolo Legato	Woodwind	Flute
2015	Bizz AF2	Syn Lead	Electronic
2016	The Bitch AT AF1&2	Syn Lead	Electronic
2017	Mellow Swell AF1&2	Pad/Choir	Warm
2018	Frozen Glasspad	Pad/Choir	Warm
2019	Lunar Eclipse AF	Pad/Choir	Bright
2020	Melting Steel AF	Pad/Choir	Choir
2021	Prayer Call	Pad/Choir	Choir
2022	Bass n' Gate	Pad/Choir	Rock/Pop
2023	PWM Stabs	Syn Comp	Analog
2024	Queen of Pop AF1&2	Syn Comp	Analog
2025	Multi Bell	Syn Comp	Electronic
2026	Acid 'n Space AF	Syn Comp	Electronic
2027	Middle Ear AF1&2	Syn Comp	Electronic
2028	Badger AF1&2	Syn Comp	Electronic
2029	Voodoo Wah	Syn Comp	Electronic
2030	Jumping Wheel AF	Syn Comp	Electronic

No.	Performance Name	Main Category	Sub Category
2031	Devils Wah AF1&2	Syn Comp	Electronic
2032	Horizons AF1&2	Syn Comp	Electronic
2033	Hypnotic AF1&2	Syn Comp	Electronic
2034	Airy Buzz AF1&2	Syn Comp	Electronic
2035	Trancious Stepz	Syn Comp	Electronic
2036	Trilogy AF1&2	Syn Comp	Electronic
2037	PWM Picks AF1&2	Syn Comp	Electronic
2038	VariChord AT AF1&2	Syn Comp	Electronic
2039	Voxdance AT AF1&2	Syn Comp	Electronic
2040	Spacewave Dancer	Sound FX	Moving
2041	Berimbau Ookawatton	Musical FX	Moving
2042	Club Telemetrix	Musical FX	Moving
2043	Venusian Rhumba	Musical FX	Moving
2044	Dripping Quarks	Musical FX	Ambient
2045	Undulator	Musical FX	Ambient
2046	Expanse	Musical FX	Ambient
2047	Deep Motion AF1&2	Musical FX	Ambient
2048	Metallic Airstabs	Musical FX	Ambient
2049	Descendant	Musical FX	Ambient
2050	Angel in Love	Musical FX	Moving
2051	Berlin Dreamz	Musical FX	Moving
2052	Complexions AF1&2	Musical FX	Moving
2053	Crazy Groove AF1&2	Musical FX	Moving
2054	Da Thumperz	Musical FX	Moving
2055	Meister Chilla	Musical FX	Moving
2056	X-Generator AF1&2	Musical FX	Moving
2057	Glaring Message AF	Musical FX	Moving
2058	Sitar 2	Ethnic	Plucked
2059	India Harmonium	Ethnic	Jazz/World
2060	Berimbau	Ethnic	Struck
2061	Banjo 2	Ethnic	Plucked
2062	Nu Orc Percussion	Drum / Perc	Percussion
2063	8Z Cajon	Drum / Perc	Drums
2064	8Z Djembe	Drum / Perc	Drums
2065	8Z Static	Drum / Perc	Drums
2066	8Z RX11	Drum / Perc	Drums
2067	8Z Trance Basics 2	Drum / Perc	Drums
2068	8Z Tom Heartz	Drum / Perc	Drums
2069	Mega 1coil Old R&R	Guitar	Electric Clean
2070	Mega Jazz Guitar	Guitar	Electric Clean
2071	PowerStandardKit 1	Drum / Perc	Drums
2072	PowerStandardKit 2	Drum / Perc	Drums
2073	Hyper Standard Kit	Drum / Perc	Drums
2074	Dry Standard Kit	Drum / Perc	Drums
2075	Modern Rock Kit	Drum / Perc	Drums
2076	Rock Stereo Kit 1	Drum / Perc	Drums
2077	Rock Stereo Kit 2	Drum / Perc	Drums
2078	Nu Hip Hop Kit 1	Drum / Perc	Drums
2079	Nu Hip Hop Kit 2	Drum / Perc	Drums
2080	Hip Hop Kit 1	Drum / Perc	Drums
2081	Hip Hop Kit 2	Drum / Perc	Drums
2082	Hip Hop Kit 3	Drum / Perc	Drums
2083	Hip Hop Kit 4	Drum / Perc	Drums
2084	Hip Stick Kit 1	Drum / Perc	Drums
2085	Hip Stick Kit 2	Drum / Perc	Drums
2086	R&B Kit 1	Drum / Perc	Drums
2087	R&B Kit 2	Drum / Perc	Drums
2088	R&B Kit 3	Drum / Perc	Drums
2089	Trance Kit	Drum / Perc	Drums
2090	Psychedelic Kit	Drum / Perc	Drums
2091	Chill Out Kit	Drum / Perc	Drums
2092	Brush Kit	Drum / Perc	Drums
2093	Jazz Kit	Drum / Perc	Drums
2094	Pop Latin Kit	Drum / Perc	Percussion
2095	Analog T9 Kit	Drum / Perc	Drums
2096	Analog T8 Kit	Drum / Perc	Drums
2097	Tekno Kit	Drum / Perc	Drums
2098	House Kit 1	Drum / Perc	Drums
2099	House Kit 2	Drum / Perc	Drums
2100	HouseCompressedKit	Drum / Perc	Drums

No.	Performance Name	Main Category	Sub Category
2101	Big Kit	Drum / Perc	Drums
2102	Break Kit	Drum / Perc	Drums
2103	Drum'n'Bass Kit	Drum / Perc	Drums
2104	Acid Kit	Drum / Perc	Drums
2105	Jungle Kit	Drum / Perc	Drums
2106	Electric Kit	Drum / Perc	Drums
2107	Human Kit	Drum / Perc	Drums
2108	Hard Kit	Drum / Perc	Drums
2109	Distorted Kit	Drum / Perc	Drums
2110	Ambient Kit	Drum / Perc	Drums
2111	Garage Kit	Drum / Perc	Drums
2112	Synth Pop Kit	Drum / Perc	Drums
2113	Orchestra Kit	Drum / Perc	Drums
2114	Drum Machines Kit	Drum / Perc	Drums
2115	Rock Multiple Kits	Drum / Perc	Drums
2116	HipHopMultipleKits	Drum / Perc	Drums
2117	Percussion Kit	Drum / Perc	Percussion
2118	LatinPercussionKit	Drum / Perc	Percussion
2119	Guitar/Bass FX Kit	Drum / Perc	Percussion
2120	Wacko Kit	Drum / Perc	Percussion
2121	Wood Bits Kit	Drum / Perc	Percussion
2122	Metal Bits Kit	Drum / Perc	Percussion
2123	Hands Kit	Drum / Perc	Percussion
2124	Scratches	Drum / Perc	Percussion
2125	Acoustic Snares	Drum / Perc	Drums
2126	Grouped St Snares	Drum / Perc	Drums
2127	All Kicks	Drum / Perc	Drums
2128	Dance Kicks	Drum / Perc	Drums
2129	Arabic Mixed Kit 1	Drum / Perc	Drums
2130	Belly Dance Kit	Drum / Perc	Drums
2131	Dance Snares	Drum / Perc	Drums
2132	Special SFXs	Drum / Perc	Percussion
2133	Synthetic Kit	Drum / Perc	Drums
2134	SFX Kit	Drum / Perc	Percussion
2135	Stereo GM Kit	Drum / Perc	Drums
2136	Maple Custom Kit	Drum / Perc	Drums
2137	Oak Custom Kit	Drum / Perc	Drums
2138	Nu Jazzy Kit	Drum / Perc	Drums
2139	Illest Hip Hop Kit	Drum / Perc	Drums
2140	Perc Master Kit	Drum / Perc	Percussion
2141	Nu Orchestra Kit	Drum / Perc	Drums
2142	Japan Kit	Drum / Perc	Percussion
2143	Turkish Kit	Drum / Perc	Percussion
2144	*1 Piano Electro	Piano	Electronic
2145	*1 Neon Girlz	Syn Comp	Electronic
2146	*1 Altered States	Guitar	Rock/Pop
2147	*1 Lurch	Syn Comp	R&B/Hip Hop
2148	*1 Indian Xperience	Syn Comp	Electronic
2149	*1 Clavi 70's 1	Keyboard	Jazz/World
2150	*1 Purple Stone	Pad/Choir	Electronic
2151	*1 Fountain	Musical FX	Ambient
2152	*1 Lighthouse	Syn Comp	Electronic
2153	*1 Commander	Chromatic Perc	Pitched Drum
2154	*1 Open The Door	Organ	Rock/Pop
2155	*1 Jazz Lounge	Piano	Jazz/World
2156	*1 Inner Wind	Syn Comp	Electronic
2157	*1 Acid Shuffle	Syn Comp	R&B/Hip Hop
2158	*1 Pass the Naan	Ethnic	Jazz/World
2159	*1 Secret Film	Syn Comp	Electronic
2160	*1 Night Train	Pad/Choir	Electronic
2161	*1 Trance Vision	Syn Comp	Electronic
2162	*1 Rule The Earth	Syn Comp	Rock/Pop
2163	*1 Jammin	Keyboard	R&B/Hip Hop
2164	*1 Wah't's This	Syn Comp	Electronic
2165	*1 Auto Funk 1	Woodwind	Jazz/World
2166	*1 Electric Mystery	Syn Comp	Electronic
2167	*1 Complex Beauty	Pad/Choir	Warm
2168	*1 Cool Madness	Syn Lead	Electronic
2169	*1 Yamaha Concerto	Strings	Ensemble
2170	*1 Big Watches	Pad/Choir	Rock/Pop

No.	Performance Name	Main Category	Sub Category
2171	*1 Swingin' Organ Club	Organ	Jazz/World
2172	*1 Cool Breakz	Syn Comp	Electronic
2173	*1 Rolla Freqs	Organ	R&B/Hip Hop
2174	*1 Piccolo Party	Woodwind	Jazz/World
2175	*1 Hand Mates	Musical FX	Electronic
2176	*1 Silent Lake	Piano	Electronic
2177	*1 Sweet Peaches	Syn Comp	Electronic
2178	*1 New Grunge	Guitar	Rock/Pop
2179	*1 4rims & a Microphone	Ethnic	R&B/Hip Hop
2180	*1 Dub Bursts	Musical FX	Electronic
2181	*1 Auto Funk 2	Brass	Jazz/World
2182	*1 Bacteria	Syn Comp	Electronic
2183	*1 Falling Monks	Pad/Choir	Choir
2184	*1 Dancing Sonar	Bass	R&B/Hip Hop
2185	*1 Baroque Ensemble	Strings	Ensemble
2186	*1 Sunny Beaches	Organ	Rock/Pop
2187	*1 Bebop Trio	Guitar	Jazz/World
2188	*1 Elektrik Arcade	Musical FX	Electronic
2189	*1 Fairy Tale	Strings	Pizzicato
2190	*1 Brazil Pop	Piano	Jazz/World
2191	*1 Chaos Layer	Musical FX	Electronic
2192	*1 Gentle Chillgroove	Pad/Choir	Electronic
2193	*1 Distorted Dreamz	Syn Comp	Electronic
2194	*1 Into The Sunset	Guitar	Rock/Pop
2195	*1 Club Beat	Syn Comp	R&B/Hip Hop
2196	*1 Super Ninja Shot!	Syn Comp	Electronic
2197	*1 Clavi 70's 2	Keyboard	Jazz/World
2198	*1 Peanut Butter Slices	Syn Comp	Electronic
2199	*1 Warm Plasma	Musical FX	Ambient
2200	*1 Drummers of Tokyo	Syn Comp	Rock/Pop
2201	*1 Epic Orchestra	Brass	Orchestra
2202	*1 Piano Boogie	Piano	Rock/Pop
2203	*1 Sunset Horn	Brass	Jazz/World
2204	*1 Lush Auto Comp	Syn Comp	Electronic
2205	*1 Don't Look!	Pad/Choir	R&B/Hip Hop
2206	*1 Japan Festival	Ethnic	Jazz/World
2207	*1 Cloudy Bay	Pad/Choir	Choir
2208	*1 Sneaking Diamonds	Pad/Choir	Electronic
2209	*1 Plutonium Freezer	Syn Comp	Electronic
2210	*1 Alternative Pop	Guitar	Rock/Pop
2211	*1 GarageHopTrumpetBoi	Brass	R&B/Hip Hop
2212	*1 Whole Lotta 8ths	Guitar	Rock/Pop
2213	*1 Timbale Jam	Brass	R&B/Hip Hop
2214	*1 Laser Scratch	Musical FX	Electronic
2215	*1 Sands of Time	Musical FX	Ambient
2216	*1 Confyooshus	Musical FX	Electronic
2217	*1 Fugue in D Minor	Brass	Orchestra
2218	*1 Love Her Crazyly	Organ	Rock/Pop
2219	*1 Jazz Vibe	Chromatic Perc	Jazz/World
2220	*1 Magnetic Fields	Syn Comp	Electronic
2221	*1 Hip Hop Orchestra	Strings	R&B/Hip Hop
2222	*1 Mallet Groove	Chromatic Perc	Jazz/World
2223	*1 Eighties Dreams	Pad/Choir	Electronic
2224	*1 Just Relax	Pad/Choir	Electronic
2225	*1 Headspinz	Musical FX	Electronic
2226	*1 Rockin' the Country	Guitar	Rock/Pop
2227	*1 Southern Rap Cat	Musical FX	R&B/Hip Hop
2228	*1 Rusted Beat	Syn Lead	Electronic
2229	*1 Tenor to the Max	Woodwind	Jazz/World
2230	*1 Chain Saw	Musical FX	Electronic
2231	*1 ARP Duo	Syn Comp	Electronic
2232	*1 Organs In Space	Musical FX	Electronic
2233	*1 The Birth Of Life	Strings	Ensemble
2234	*1 60s Border Town	Syn Lead	Rock/Pop
2235	*1 Late Show	Chromatic Perc	Jazz/World
2236	*1 Synthlines	Bass	Electronic
2237	*1 Schmusin'	Keyboard	R&B/Hip Hop
2238	*1 Andalucia Wind	Guitar	Rock/Pop
2239	*1 Raging Waves	Musical FX	Moving
2240	*1 Night Walk	Pad/Choir	Electronic

No.		Performance Name	Main Category	Sub Category
2241	*1	Glowing Socks	Syn Comp	Electronic
2242	*1	Auto Ballad	Woodwind	Rock/Pop
2243	*1	Trip Groove	Musical FX	R&B/Hip Hop
2244	*1	Atomic Bouncer	Syn Comp	Electronic
2245	*1	Soulful EP Player	Keyboard	R&B/Hip Hop
2246	*1	Buttoned Down	Syn Comp	Electronic
2247	*1	Frosted World	Musical FX	Moving
2248	*1	Electrix	Syn Comp	Electronic
2249	*1	Worship Center	Strings	Ensemble
2250	*1	Cheep King	Organ	Rock/Pop
2251	*1	Waltzing Quartet	Piano	Jazz/World
2252	*1	Chill Performer	Keyboard	Electronic
2253	*1	Harp/Piccolo	Strings	Pizzicato
2254	*1	Homeward Bound	Ethnic	Electronic
2255	*1	Lava Rhythm	Musical FX	Moving
2256	*1	Coded Message	Pad/Choir	Electronic
2257	*1	Mirror Wave	Syn Comp	Electronic
2258	*1	80's Drummer	Drum / Perc	Rock/Pop
2259	*1	The Clapper	Sound FX	R&B/Hip Hop
2260	*1	Fata Morgana	Syn Comp	Electronic
2261	*1	Hot E.P. Noodles	Keyboard	R&B/Hip Hop
2262	*1	Between the Lines	Musical FX	Electronic
2263	*1	Ice Pizz	Syn Comp	Electronic
2264	*1	Welder	Syn Comp	Electronic
2265	*1	Strings/FrenchHorns	Strings	Ensemble
2266	*1	Minor Mood	Organ	Rock/Pop
2267	*1	Nitehawks	Brass	Jazz/World
2268	*1	Talk Show Band	Brass	R&B/Hip Hop
2269	*1	Pastoral	Strings	Pizzicato
2270	*1	Smooth Guitar	Guitar	Jazz/World
2271	*1	Intimacy	Chromatic Perc	Bell
2272	*1	Chilltronika	Pad/Choir	Electronic
2273	*1	East Sider	Syn Lead	R&B/Hip Hop
2274	*1	Dreamscape	Strings	Ensemble
2275	*1	Sub-sonic	Syn Lead	Electronic
2276	*1	Chilln Keys	Piano	Electronic
2277	*1	Urban Shuffle	Woodwind	Rock/Pop
2278	*1	Green Oasis	Pad/Choir	Warm
2279	*1	Andy Lucia	Guitar	Jazz/World
2280	*1	Heart Breakz	Syn Comp	Electronic
2281	*1	Bop till you Drop	Piano	Jazz/World
2282	*1	White Sand Dub	Sound FX	Electronic
2283	*1	Double Dip the Funk	Guitar	R&B/Hip Hop
2284	*1	Echo in the Night	Syn Comp	Rock/Pop
2285	*1	Electro Club	Syn Comp	Electronic
2286	*1	Slow and Low	Keyboard	R&B/Hip Hop
2287	*1	Abys of the Sea	Pad/Choir	Bright
2288	*1	Second Breakfast	Pad/Choir	Electronic
2289	*1	Coastal	Woodwind	R&B/Hip Hop
2290	*1	Semi Finale	Brass	Orchestra
2291	*1	DRY-Wash	Musical FX	Electronic
2292	*1	Warm Feeling	Pad/Choir	Electronic
2293	*1	Strummin'&Hummin'	Guitar	Rock/Pop
2294	*1	Ukigumo	Musical FX	Ambient
2295	*1	Bellydancer	Ethnic	Jazz/World
2296	*1	Chart Breaker	Syn Comp	Electronic
2297	*1	Smooth It Over	Woodwind	Jazz/World
2298	*1	Sample & Hold	Sound FX	Electronic
2299	*1	Funky Finger	Keyboard	R&B/Hip Hop
2300	*1	Yearn to see You	Musical FX	Ambient
2301	*1	Big Beater	Syn Comp	Electronic
2302	*1	Organ Cruise	Organ	R&B/Hip Hop
2303	*1	Oyashio	Sound FX	Moving
2304	*1	Synth Power	Brass	Rock/Pop
2305	*1	Yah-Yo-Jah	Guitar	R&B/Hip Hop
2306	*1	Trumpet Concert	Brass	Orchestra
2307	*1	Dancing Bars	Syn Comp	Rock/Pop
2308	*1	Nightshadows	Guitar	Electronic
2309	*1	Hold On a Minute	Keyboard	R&B/Hip Hop
2310	*1	Kogarashi	Musical FX	Moving

No.		Performance Name	Main Category	Sub Category
2311	*1	Hot Sauce	Brass	Jazz/World
2312	*1	Cosmic Trance	Syn Comp	Electronic
2313	*1	Blues Organ Trio	Organ	Jazz/World
2314	*1	Jembrana	Musical FX	Electronic
2315	*1	Clavi Jam	Keyboard	R&B/Hip Hop
2316	*1	Free Fall	Guitar	Rock/Pop
2317	*1	Tollhouse	Syn Comp	Electronic
2318	*1	String Accompaniment	Strings	Ensemble
2319	*1	Arianes Nightwalk	Syn Comp	Digital
2320	*1	Semar Dub	Syn Comp	Electronic
2321	*1	Casbian Nights	Ethnic	R&B/Hip Hop
2322	*1	Requiem	Strings	Ensemble
2323	*1	Broiling	Syn Lead	Electronic
2324	*1	Wobbly Keys	Keyboard	Electronic
2325	*1	Rock of the 80's	Guitar	Rock/Pop
2326	*1	Crying Scene	Pad/Choir	Analog
2327	*1	Two Hands of Latin	Guitar	Jazz/World
2328	*1	Funfair	Syn Comp	Electronic
2329	*1	Night Cruiser	Keyboard	Jazz/World
2330	*1	Meeting Point	Musical FX	Ambient
2331	*1	Analog Power	Syn Comp	R&B/Hip Hop
2332	*1	Sarah's Dream	Pad/Choir	Bright
2333	*1	Pursuer	Syn Comp	Electronic
2334	*1	Worship	Organ	R&B/Hip Hop
2335	*1	Euro Animation	Musical FX	Moving
2336	*1	Poppyhanger	Pad/Choir	Electronic
2337	*1	City Groove	Syn Lead	R&B/Hip Hop
2338	*1	Winds & Strings	Strings	Ensemble
2339	*1	Deep House 1	Syn Comp	Electronic
2340	*1	Wet Reflected Lights	Syn Comp	Electronic
2341	*1	Classic Shuffle Rock	Organ	Rock/Pop
2342	*1	Silent Spheres	Pad/Choir	Choir
2343	*1	World Beat	Ethnic	Jazz/World
2344	*1	Cool Box	Syn Comp	Electronic
2345	*1	Let's Comp!	Piano	Jazz/World
2346	*1	Kuroshio	Musical FX	Ambient
2347	*1	Acid Club	Keyboard	Jazz/World
2348	*1	Haze o' Phase	Syn Comp	Electronic
2349	*1	Gran Beat	Syn Lead	Electronic
2350	*1	Lake Side	Piano	Acoustic
2351	*1	Sprinkler	Pad/Choir	Choir
2352	*1	Dub City	Pad/Choir	Electronic
2353	*1	West Coast Interact	Piano	R&B/Hip Hop
2354	*1	Oboe Soloist	Woodwind	Reed / Pipe
2355	*1	Electric Monkeys	Musical FX	Electronic
2356	*1	Chilly Dreams	Pad/Choir	Electronic
2357	*1	Echo Park Rock	Guitar	Rock/Pop
2358	*1	Angel Pad	Pad/Choir	Choir
2359	*1	Latin 4 Beginners	Woodwind	Jazz/World
2360	*1	What is he doing?	Musical FX	Electronic
2361	*1	Duck Groove	Syn Lead	Jazz/World
2362	*1	Java Winds	Chromatic Perc	Bell
2363	*1	Funky Jump	Guitar	R&B/Hip Hop
2364	*1	Club Jazz 1	Keyboard	Jazz/World
2365	*1	Machine-Run	Syn Lead	Electronic
2366	*1	Full Monty	Organ	Tone Wheel
2367	*1	Kyuketsuki	Pad/Choir	Warm
2368	*1	Auto Running	Pad/Choir	Electronic
2369	*1	Bubblicious	Pad/Choir	R&B/Hip Hop
2370	*1	The Woodwind Section	Woodwind	Flute
2371	*1	Maison Blanc	Syn Comp	Electronic
2372	*1	Bristol	Piano	Electronic
2373	*1	Friday Night	Guitar	Rock/Pop
2374	*1	Lake Pad	Strings	Synth
2375	*1	Canto de rua	Woodwind	Jazz/World
2376	*1	Pound-a-thon	Musical FX	Electronic
2377	*1	Film Noir	Woodwind	Jazz/World
2378	*1	Teatime	Musical FX	Moving
2379	*1	Funk Jam	Keyboard	R&B/Hip Hop
2380	*1	Rattle and Roll	Musical FX	R&B/Hip Hop

No.		Performance Name	Main Category	Sub Category
2381	*1	Club 80's	Syn Comp	Electronic
2382	*1	2 Manuals	Organ	Tone Wheel
2383	*1	Needle Penalty	Musical FX	Ambient
2384	*1	Magic Spell	Pad/Choir	Electronic
2385	*1	The Duece	Ethnic	R&B/Hip Hop
2386	*1	Movie Strings	Strings	Ensemble
2387	*1	Nasty Dirty Funky	Musical FX	Electronic
2388	*1	Traumzeit	Piano	Electronic
2389	*1	Austin City Blues	Guitar	Rock/Pop
2390	*1	Creepn Worm	Musical FX	Sweep
2391	*1	2 Guitars for Mrs R	Guitar	Acoustic
2392	*1	Subway Traxx Trigger	Syn Comp	Electronic
2393	*1	Dream Shuffle	Pad/Choir	Rock/Pop
2394	*1	Snow na Oto	Musical FX	Moving
2395	*1	Thrust	Keyboard	Jazz/World
2396	*1	Elfin Dreams	Musical FX	Electronic
2397	*1	Crowded Place	Musical FX	Electronic
2398	*1	American Beauty	Piano	Acoustic
2399	*1	Space Gallery	Musical FX	Moving
2400	*1	Crushy Jegog	Pad/Choir	Electronic
2401	*1	Hip Hop Girl	Strings	R&B/Hip Hop
2402	*1	Welcome to Sirius	Sound FX	Moving
2403	*1	Brit Piano Pop	Piano	Rock/Pop
2404	*1	BleePAD	Keyboard	FM Piano
2405	*1	Orchestra Del Mar	Pad/Choir	Rock/Pop
2406	*1	Let the Music Play	Guitar	Rock/Pop
2407	*1	Bubbly Dub	Organ	Jazz/World
2408	*1	Toys	Musical FX	Moving
2409	*1	Blues Spell	Piano	Rock/Pop
2410	*1	Random Breakz	Pad/Choir	Electronic
2411	*1	Piano+Analog Kit	Piano	Rock/Pop
2412	*1	Dubrin!	Sound FX	Sci-Fi
2413	*1	Big Beat Trigger	Syn Comp	Electronic
2414	*1	Deborah in love	Pad/Choir	Bright
2415	*1	Psychic Trance	Syn Comp	Electronic
2416	*1	Power Worxx	Syn Comp	Electronic
2417	*1	Vanilla Wrapper	Keyboard	R&B/Hip Hop
2418	*1	Blue Horizon	Pad/Choir	Warm
2419	*1	21st Century Bruce	Pad/Choir	Rock/Pop
2420	*1	Ethereal	Pad/Choir	Choir
2421	*1	Istanbul	Pad/Choir	Warm
2422	*1	Prog Rocker	Guitar	Rock/Pop
2423	*1	Samba Electric	Syn Lead	Jazz/World
2424	*1	Rivers of Stars	Pad/Choir	Electronic
2425	*1	Funk Night	Brass	R&B/Hip Hop
2426	*1	Sneaky Neutrons	Musical FX	Electronic
2427	*1	Love Songs	Keyboard	R&B/Hip Hop
2428	*1	Bell Doesn't Ring	Musical FX	Moving
2429	*1	Body Pumping	Guitar	Rock/Pop
2430	*1	Arctic Landscape	Musical FX	Ambient
2431	*1	Ambient Trigger	Keyboard	Electronic
2432	*1	Rain Dance	Pad/Choir	Electronic
2433	*1	Dirty South	Syn Comp	R&B/Hip Hop
2434	*1	Labyrinth	Musical FX	Ambient
2435	*1	Acoustic Piano Man	Piano	Rock/Pop
2436	*1	Scattered Beatz	Musical FX	Electronic
2437	*1	Soft Analog	Syn Comp	R&B/Hip Hop
2438	*1	12 O'Clock High	Guitar	Rock/Pop
2439	*1	Guitar Duo	Guitar	Jazz/World
2440	*1	U make me crazy!	Syn Lead	Electronic
2441	*1	Organ Jam	Organ	Jazz/World
2442	*1	Wild Heart	Guitar	Rock/Pop
2443	*1	Sweet Club	Strings	R&B/Hip Hop
2444	*1	What'so funny?	Bass	Synth
2445	*1	Alternative1 Trigger	Guitar	Rock/Pop
2446	*1	4zone	Bass	Synth
2447	*1	Trance Trigger	Syn Comp	Electronic
2448	*1	Club 2007	Syn Comp	Electronic
2449	*1	Money on My Mind	Guitar	R&B/Hip Hop
2450	*1	Gate Orch	Pad/Choir	Analog

No.		Performance Name	Main Category	Sub Category
2451	*1	Lay Me Down to Sleep	Piano	Rock/Pop
2452	*1	Komorebi	Musical FX	Moving
2453	*1	All Guitars	Guitar	Acoustic
2454	*1	Retrock	Organ	Rock/Pop
2455	*1	Decadent World	Ethnic	Jazz/World
2456	*1	Talking Wizzards	Musical FX	Electronic
2457	*1	W Coast '80	Keyboard	Jazz/World
2458	*1	Continental	Organ	Rock/Pop
2459	*1	Cloudy Morning	Keyboard	R&B/Hip Hop
2460	*1	KURA-KURA	Musical FX	Moving
2461	*1	Dest Electra	Guitar	Electronic
2462	*1	Nuclear Fusion	Musical FX	Ambient
2463	*1	Rolling City	Sound FX	Electronic
2464	*1	Jazzy Garage	Syn Comp	Electronic
2465	*1	City Beats	Strings	R&B/Hip Hop
2466	*1	Evolving Spheres	Pad/Choir	Warm
2467	*1	Jack Does it Again	Keyboard	Rock/Pop
2468	*1	Psychobot Beat	Musical FX	Electronic
2469	*1	Endless Summer	Guitar	Rock/Pop
2470	*1	Surfin' Kahuna	Organ	Rock/Pop
2471	*1	Tropic Groove	Organ	Jazz/World
2472	*1	Cosmic Bullets	Musical FX	Electronic
2473	*1	Hopit	Keyboard	Jazz/World
2474	*1	Portable	Organ	Rock/Pop
2475	*1	Wurli Ballad	Keyboard	Rock/Pop
2476	*1	Intelligent Static	Sound FX	Electronic
2477	*1	Progressive Trance	Musical FX	Electronic
2478	*1	Circle of environmen	Musical FX	Moving
2479	*1	Straight Line	Syn Comp	Electronic
2480	*1	Rising Beat	Pad/Choir	Electronic
2481	*1	Bring the Bling	Keyboard	R&B/Hip Hop
2482	*1	Magic Carpet	Musical FX	Moving
2483	*1	Classic Rock	Organ	Rock/Pop
2484	*1	Tamfen-Loop	Sound FX	Electronic
2485	*1	Campfire Split	Guitar	Acoustic
2486	*1	Jukebox	Woodwind	Rock/Pop
2487	*1	Martini Orbit	Syn Lead	Jazz/World
2488	*1	Wah Dub	Musical FX	Electronic
2489	*1	Smooth Lead Jam	Syn Lead	Jazz/World
2490	*1	Metabolize	Syn Comp	Electronic
2491	*1	Dream Grand	Piano	Acoustic
2492	*1	Petit Dark	Musical FX	Ambient
2493	*1	Breakbeat 1	Musical FX	Electronic
2494	*1	Insane Circuits	Sound FX	Sci-Fi
2495	*1	In a Trance	Syn Comp	Electronic
2496	*1	Deep House 2	Syn Comp	Electronic
2497	*1	Southern Rap 1	Syn Comp	R&B/Hip Hop
2498	*1	Aztec Temple	Musical FX	Moving
2499	*1	Unplugged	Piano	Rock/Pop
2500	*1	Hin Daeng	Musical FX	Moving
2501	*1	Micro Disco	Syn Comp	Electronic
2502	*1	Country Gee-tars	Guitar	Rock/Pop
2503	*1	Bossa On the Beach	Woodwind	Jazz/World
2504	*1	IDM JAM	Sound FX	Electronic
2505	*1	Bluesy Moody	Keyboard	Jazz/World
2506	*1	Metalheads	Guitar	Rock/Pop
2507	*1	Fretless Ballad	Pad/Choir	Rock/Pop
2508	*1	Random Orchestra	Pad/Choir	Warm
2509	*1	Alternative2 Trigger	Guitar	Rock/Pop
2510	*1	Sea electron Bottom	Pad/Choir	Electronic
2511	*1	Ambient Fluid	Syn Comp	Electronic
2512	*1	Love Box	Pad/Choir	Electronic
2513	*1	Boom Snap	Guitar	R&B/Hip Hop
2514	*1	Robby	Syn Comp	Electronic
2515	*1	80's young gun	Syn Comp	Rock/Pop
2516	*1	Natural Woman	Pad/Choir	Electronic
2517	*1	Very Clavistitious	Keyboard	R&B/Hip Hop
2518	*1	Psychedelic Dream	Keyboard	Rock/Pop
2519	*1	Asahi ni niou	Musical FX	Sweep
2520	*1	Dust of Mars	Pad/Choir	Electronic

No.		Performance Name	Main Category	Sub Category
2521	*1	Late Walk	Keyboard	Jazz/World
2522	*1	Cityscape	Woodwind	Electronic
2523	*1	EP Ballad	Keyboard	Rock/Pop
2524	*1	Information	Sound FX	Moving
2525	*1	Squelchy Tub Thunk	Musical FX	Electronic
2526	*1	Nouveau Gangsta	Sound FX	Electronic
2527	*1	SciFi Foley - Atonal	Sound FX	Ambient
2528	*1	Proggo Rocko	Syn Lead	Rock/Pop
2529	*1	New R&B Motif Trigr	Strings	R&B/Hip Hop
2530	*1	Tumbling Galaxies	Musical FX	Ambient
2531	*1	Old School Acid	Syn Comp	Electronic
2532	*1	Vintage Rider	Keyboard	R&B/Hip Hop
2533	*1	Ethnic Dance (4ARP)	Ethnic	Jazz/World
2534	*1	When The Piggies Fly	Guitar	Rock/Pop
2535	*1	Big Apple	Brass	Jazz/World
2536	*1	The March of Progres	Brass	Ensemble
2537	*1	Club Jazz 2	Syn Comp	Jazz/World
2538	*1	Dream Ballad	Piano	Acoustic
2539	*1	Meringue	Guitar	Jazz/World
2540	*1	Mad IDM	Pad/Choir	Electronic
2541	*1	Rare Groove	Organ	Jazz/World
2542	*1	8beat Basic	Keyboard	Rock/Pop
2543	*1	Far Away from Home	Musical FX	Ambient
2544	*1	16beat Rock	Guitar	Rock/Pop
2545	*1	The Walls (4ARP)	Syn Comp	R&B/Hip Hop
2546	*1	Triathlon	Pad/Choir	Warm
2547	*1	Latin House	Syn Comp	Electronic
2548	*1	Sneak Thru the Nite	Keyboard	R&B/Hip Hop
2549	*1	Africana	Ethnic	Jazz/World
2550	*1	Worship Fast (4ARP)	Guitar	Rock/Pop
2551	*1	Jazz Breeze	Woodwind	Jazz/World
2552	*1	More Chester	Brass	Orchestra
2553	*1	Clavi Funk	Keyboard	Jazz/World
2554	*1	Gentle Support	Pad/Choir	Warm
2555	*1	Single Coil	Guitar	Acoustic
2556	*1	Bubble Techno	Sound FX	Electronic
2557	*1	'70th	Keyboard	R&B/Hip Hop
2558	*1	Newbury Street 1980	Syn Lead	Rock/Pop
2559	*1	Nashville Ballad	Piano	Rock/Pop
2560	*1	Contemporary Rock	Guitar	Rock/Pop
2561	*1	Hip Hop (4ARP)	Syn Comp	R&B/Hip Hop
2562	*1	Underground	Drum / Perc	Drums
2563	*1	Back To The Jungle	Syn Lead	Electronic
2564	*1	Slow & Easy	Keyboard	Rock/Pop
2565	*1	Maya Ruins (4ARP)	Woodwind	Jazz/World
2566	*1	Blues	Organ	Rock/Pop
2567	*1	Rag Time Strut(4ARP)	Piano	Jazz/World
2568	*1	Philharmonic	Chromatic Perc	Pitched Drum
2569	*1	Pop Shuffle	Piano	Jazz/World
2570	*1	Love Affair	Keyboard	Electric Piano
2571	*1	Spanish Romance	Guitar	Jazz/World
2572	*1	Trance-a-lator	Syn Comp	Electronic
2573	*1	Follow The Funk	Keyboard	R&B/Hip Hop
2574	*1	3 Chords & The Truth	Piano	Rock/Pop
2575	*1	Won't be a minute	Syn Lead	Rock/Pop
2576	*1	Power Rock (4ARP)	Guitar	Rock/Pop
2577	*1	Brother	Strings	R&B/Hip Hop
2578	*1	RANDAVE	Musical FX	Moving
2579	*1	Breakbeat 2 Trigger	Sound FX	Electronic
2580	*1	Funky Breath	Woodwind	R&B/Hip Hop
2581	*1	Nation Capture	Pad/Choir	Jazz/World
2582	*1	Closing Time	Organ	Rock/Pop
2583	*1	Jazz Quartet	Woodwind	Jazz/World
2584	*1	Son of Mars	Chromatic Perc	Pitched Drum
2585	*1	16beat Pop	Keyboard	Jazz/World
2586	*1	Ballad Piano&Bass	Piano	Layer
2587	*1	Southern Gtr Ballad	Guitar	Acoustic
2588	*1	Neo Half	Musical FX	Electronic
2589	*1	Dark EP Jam	Keyboard	Jazz/World
2590	*1	Motor City Rules	Piano	R&B/Hip Hop

No.		Performance Name	Main Category	Sub Category
2591	*1	Watch Out	Pad/Choir	R&B/Hip Hop
2592	*1	Death Metal (4ARP)	Guitar	Rock/Pop
2593	*1	Southern Rap 2	Ethnic	R&B/Hip Hop
2594	*1	Chemical	Sound FX	Electronic
2595	*1	Power Grid	Syn Lead	Electronic
2596	*1	ZAZA Pop	Keyboard	R&B/Hip Hop
2597	*1	Exodus	Woodwind	Jazz/World
2598	*1	Piano Boogie Woogie	Piano	Rock/Pop
2599	*1	Modern Jazz (4ARP)	Guitar	Jazz/World
2600	*1	Violin Concerto	Strings	Ensemble
2601	*1	Soul Swing	Keyboard	R&B/Hip Hop
2602	*1	Sailboarding	Pad/Choir	Warm
2603	*1	Guitar+PianoBallad	Guitar	Acoustic
2604	*1	Aqua Techno	Musical FX	Electronic
2605	*1	UK Soul	Guitar	R&B/Hip Hop
2606	*1	Heavy 8s	Pad/Choir	Rock/Pop
2607	*1	Softy	Keyboard	Jazz/World
2608	*1	Progre	Organ	Rock/Pop
2609	*1	Regeton (4ARP)	Syn Lead	R&B/Hip Hop
2610	*1	ZAVE	Musical FX	Ambient
2611	*1	Bringin Phaser(4ARP)	Syn Comp	Electronic
2612	*1	Keys 2 da Undrgrnd	Organ	R&B/Hip Hop
2613	*1	The Living Deputy	Keyboard	Jazz/World
2614	*1	8beat Rock	Guitar	Rock/Pop
2615	*1	Bombastico to E3	Piano	Jazz/World
2616	*1	Bach o' Roll	Strings	Pizzicato
2617	*1	Gospel Brothers	Keyboard	R&B/Hip Hop
2618	*1	Jazz Duo	Piano	Acoustic
2619	*1	Strummers (4ARP)	Guitar	Acoustic
2620	*1	Synthethnic	Syn Lead	Electronic
2621	*1	Hey Sixteen	Organ	Jazz/World
2622	*1	Desert Drive (4ARP)	Guitar	Rock/Pop
2623	*1	It May Sustain . . .	Pad/Choir	Electronic
2624	*1	Rockacha	Organ	Rock/Pop
2625	*1	J-Hip Rock (4ARP)	Syn Lead	R&B/Hip Hop
2626	*1	Endless	Syn Comp	Electronic
2627	*1	Long Dark Tunnel	Musical FX	Electronic
2628	*1	Soft Groover	Keyboard	R&B/Hip Hop
2629	*1	Summer Festival	Brass	Jazz/World
2630	*1	Country EP	Keyboard	Rock/Pop
2631	*1	Slow Down & Ease Up	Guitar	Jazz/World
2632	*1	ARP Piano Concerto	Piano	Layer
2633	*1	African Funk (4ARP)	Chromatic Perc	Jazz/World
2634	*1	Standing on Air	Musical FX	Ambient
2635	*1	Spanish Fiesta	Guitar	Acoustic
2636	*1	TEKNICON	Syn Comp	Electronic
2637	*1	Philly Aboard	Piano	R&B/Hip Hop
2638	*1	Northern Pop	Keyboard	Rock/Pop
2639	*1	Ibiza Growl Sax	Woodwind	Electronic
2640	*1	Shuffle Blues	Piano	Rock/Pop
2641	*1	Down Wid It Trigger	Syn Comp	R&B/Hip Hop
2642	*1	Star Gate	Pad/Choir	Warm
2643	*1	Dark Mod Drummer	Pad/Choir	R&B/Hip Hop
2644	*1	Dirty Mini	Guitar	R&B/Hip Hop
2645	*1	HillsDanceEthno 4ARP	Ethnic	Electronic
2646	*1	Slow Blues	Piano	Rock/Pop
2647	*1	Rodovia	Brass	Jazz/World
2648	*1	Big Strings	Strings	Ensemble
2649	*1	Sumo-Funk	Keyboard	R&B/Hip Hop
2650	*1	XtraTerrestrialFrogs	Pad/Choir	Bright
2651	*1	Tear It Up	Piano	R&B/Hip Hop
2652	*1	Psychro	Musical FX	Electronic
2653	*1	Just the Facts	Keyboard	Jazz/World
2654	*1	80's American (4ARP)	Syn Comp	Rock/Pop
2655	*1	Business Lunch	Pad/Choir	Electronic

Performance Category List

Main Category	Sub Category								
Piano	Acoustic	Layer	Modern	Vintage	Rock/Pop	R&B/Hip Hop	Electronic	Jazz/World	No Assign
Keyboard	Electric Piano	FM Piano	Clavi	Synth	Rock/Pop	R&B/Hip Hop	Electronic	Jazz/World	No Assign
Organ	Tone Wheel	Combo	Pipe	Synth	Rock/Pop	R&B/Hip Hop	Electronic	Jazz/World	No Assign
Guitar	Acoustic	Electric Clean	Distortion	Synth	Rock/Pop	R&B/Hip Hop	Electronic	Jazz/World	No Assign
Bass	Acoustic	Electric	Synth	Rock/Pop	R&B/Hip Hop	Electronic	Jazz/World		No Assign
Strings	Solo	Ensemble	Pizzicato	Synth	Rock/Pop	R&B/Hip Hop	Electronic	Jazz/World	No Assign
Brass	Solo	Ensemble	Orchestra	Synth	Rock/Pop	R&B/Hip Hop	Electronic	Jazz/World	No Assign
Woodwind	Saxophone	Flute	Woodwind	Reed / Pipe	Rock/Pop	R&B/Hip Hop	Electronic	Jazz/World	No Assign
Syn Lead	Analog	Digital	Hip Hop	Dance	Rock/Pop	R&B/Hip Hop	Electronic	Jazz/World	No Assign
Pad/Choir	Analog	Warm	Bright	Choir	Rock/Pop	R&B/Hip Hop	Electronic	Jazz/World	No Assign
Syn Comp	Analog	Digital	Decay	Hook	Rock/Pop	R&B/Hip Hop	Electronic	Jazz/World	No Assign
Chromatic Perc	Mallet	Bell	Synth Bell	Pitched Drum	Rock/Pop	R&B/Hip Hop	Electronic	Jazz/World	No Assign
Drum / Perc	Drums	Percussion	Synth	Rock/Pop	R&B/Hip Hop	Electronic	Jazz/World		No Assign
Sound FX	Moving	Ambient	Nature	Sci-Fi	Rock/Pop	R&B/Hip Hop	Electronic	Jazz/World	No Assign
Musical FX	Moving	Ambient	Sweep	Hit	Rock/Pop	R&B/Hip Hop	Electronic	Jazz/World	No Assign
Ethnic	Bowed	Plucked	Struck	Blown	Rock/Pop	R&B/Hip Hop	Electronic	Jazz/World	No Assign

Drum Kit Assign List

Schlager Weapon 1

Note	Wave Number	Wave Name
C0	5457	Sd TB Comp1
C#0	5456	Sd TB Q
D0	2531	Abstract Fx1
D#0	2534	Abstract Fx4
E0	2537	Damage Fx1
F0	2536	Bazer Fx
F#0	2539	Damage Fx3
G0	2532	Abstract Fx2
G#0	2563	Electric Fx Perc8
A0	4688	Dub BD 2 St
A#0	5451	Sd ShortDry2
B0	4688	Dub BD 2 St
C1	4688	Dub BD 2 St
C#1	5452	Sd ShortGate1
D1	5456	Sd TB Q
D#1	4190	RX11 Clap
E1	5445	Sd Clap1
F1	6138	Comp EleTom Low
F#1	5830	Trap HH 3 St
G1	6138	Comp EleTom Low
G#1	5822	HH TecClosed2
A1	6138	Comp EleTom Low
A#1	5819	HH OpenNine
B1	6137	Comp EleTom High
C2	6137	Comp EleTom High
C#2	6199	PI Crash 15
D2	6137	Comp EleTom High
D#2	6262	Fine Ride Bow
E2	6292	China4
F2	6264	Fine Ride Cup
F#2	3088	Pandeiro1 Tip
G2	6200	PI Crash 16
G#2	2513	Hi Q2
A2	6200	PI Crash 16
A#2	2513	Hi Q2
B2	6338	Electro Ride Mn
C3	2790	Acoustic Bass FX07
C#3	2281	Mini Brip6
D3	2844	Tambourine1 Shake
D#3	2277	Mini Brip2
E3	2967	Quinto1 Slap
F3	3288	Tabla1 Bya
F#3	3272	Djembe1 Edge
G3	3289	Tabla1 Nah
G#3	3545	Barasim Tak
A3	4188	Electric Clap1
A#3	2820	ShakerB Sw
B3	2392	Hop FX1
C4	2550	Noize Fx1
C#4	2552	Noize Rize1
D4	2553	Noize Rize2
D#4	2533	Abstract Fx3
E4	2535	Abstract Fx5
F4	4286	Analog Click
F#4	5780	HH Closed T8-1
G4	5431	Sd FM
G#4	5570	HH Half Open2 RL
A4	4276	Claves T8-1
A#4	5781	HH Open T8-1
B4	6346	Reverse Cymbal1
C5	4558	Bd DanceGate1
C#5	4681	Bd EDM Gate
D5	4559	Bd DanceGate2
D#5	2547	Damage Fx11
E5	4662	Bd Stack3
F5	4680	Bd EDM10
F#5	5178	Sd BreakRim
G5	2570	Electric Fx Perc15
G#5	2551	Noize Fx2
A5	2544	Damage Fx8
A#5	2561	Electric Fx Perc6
B5	2559	Electric Fx Perc4
C6	2564	Electric Fx Perc9

Early 80s DiscoPop

Note	Wave Number	Wave Name
C0	4671	Bd EDM01
C#0	5393	Sd AnCR
D0	5353	Sd T9-5
D#0	4190	RX11 Clap
E0	5354	Sd T9Gate
F0	5206	Sd RockRoll St
F#0	5351	Sd T9-3
G0	5352	Sd T9-4
G#0	5354	Sd T9Gate
A0	4563	Bd T9-4
A#0	5353	Sd T9-5
B0	4560	Bd T9-1
C1	4671	Bd EDM01
C#1	5355	Sd T9Rim
D1	5349	Sd T9-1
D#1	4190	RX11 Clap
E1	5350	Sd T9-2
F1	6107	Tom T9 Lo
F#1	5795	HH Closed RX11
G1	6107	Tom T9 Lo
G#1	5767	HH Open T9
A1	6107	Tom T9 Lo
A#1	5796	HH Open RX11
B1	6106	Tom T9 Hi
C2	3062	Cabasa1A 1-2
C#2	6303	Crash T9-1
D2	3858	Tombek Tek Dead Sw
D#2	4247	Cowbell RX11
E2	6287	China2
F2	6281	Ride Cup Mono
F#2	4258	Tambourine RX5
G2	6179	Crash3
G#2	3223	Cowbell1
A2	6180	Crash4
A#2	4242	Cowbell T8
B2	6231	Ride2 R
C3	4231	Conga T8
C#3	4231	Conga T8
D3	2922	Conga1 Hi Tip
D#3	2928	Conga1 Hi Slap Open
E3	2926	Conga1 Hi Open 2
F3	3026	Timbale1 Hi 1-3
F#3	3030	Timbale1 Lo 1-2
G3	4286	Analog Click
G#3	4231	Conga T8
A3	3062	Cabasa1A 1-2
A#3	3059	Maracas1 Slur
B3	2613	FxGun2
C4	2612	FxGun1
C#4	2629	Scratch H
D4	2631	Scratch Down
D#4	2512	Hi Q1
E4	2512	Hi Q1
F4	2513	Hi Q2
F#4	2630	Scratch L
G4	2630	Scratch L
G#4	2884	Triangle1 Mute
A4	2883	Triangle1 Open
A#4	4250	Analog Shaker
B4	2908	Sleigh Bell1
C5	2912	Wind Chime 1
C#5	4959	Sd Piccolo
D5	5380	Sd T8-5
D#5	5209	Sd RockRollID St
E5	5227	Sd Brush Med St
F5	4596	Bd BlpHd
F#5	5397	Sd Jungle1
G5	4629	Bd Sustain
G#5	5401	Sd D&B1
A5	4607	Bd Break2
A#5	5427	Sd Dist
B5	4630	Bd TekPower
C6	4615	Bd Distortion RM

Midnight Funk

Note	Wave Number	Wave Name
C0	4671	Bd EDM01
C#0	5393	Sd AnCR
D0	5353	Sd T9-5
D#0	4190	RX11 Clap
E0	5354	Sd T9Gate
F0	5206	Sd RockRoll St
F#0	5351	Sd T9-3
G0	5352	Sd T9-4
G#0	5354	Sd T9Gate
A0	4563	Bd T9-4
A#0	5353	Sd T9-5
B0	4560	Bd T9-1
C1	4671	Bd EDM01
C#1	5355	Sd T9Rim
D1	5349	Sd T9-1
D#1	4190	RX11 Clap
E1	5350	Sd T9-2
F1	6107	Tom T9 Lo
F#1	5795	HH Closed RX11
G1	6107	Tom T9 Lo
G#1	5767	HH Open T9
A1	6107	Tom T9 Lo
A#1	5796	HH Open RX11
B1	6106	Tom T9 Hi
C2	3062	Cabasa1A 1-2
C#2	6303	Crash T9-1
D2	3858	Tombek Tek Dead Sw
D#2	4247	Cowbell RX11
E2	6287	China2
F2	6281	Ride Cup Mono
F#2	4258	Tambourine RX5
G2	6179	Crash3
G#2	3223	Cowbell1
A2	6180	Crash4
A#2	4242	Cowbell T8
B2	6231	Ride2 R
C3	4231	Conga T8
C#3	4231	Conga T8
D3	2922	Conga1 Hi Tip
D#3	2928	Conga1 Hi Slap Open
E3	2926	Conga1 Hi Open 2
F3	3026	Timbale1 Hi 1-3
F#3	3030	Timbale1 Lo 1-2
G3	4286	Analog Click
G#3	4231	Conga T8
A3	3062	Cabasa1A 1-2
A#3	3059	Maracas1 Slur
B3	2613	FxGun2
C4	2612	FxGun1
C#4	2629	Scratch H
D4	2631	Scratch Down
D#4	2512	Hi Q1
E4	2512	Hi Q1
F4	2513	Hi Q2
F#4	2630	Scratch L
G4	2630	Scratch L
G#4	2884	Triangle1 Mute
A4	2883	Triangle1 Open
A#4	4250	Analog Shaker
B4	2908	Sleigh Bell1
C5	2912	Wind Chime 1
C#5	4959	Sd Piccolo
D5	5380	Sd T8-5
D#5	5209	Sd RockRollID St
E5	5227	Sd Brush Med St
F5	4596	Bd BlpHd
F#5	5397	Sd Jungle1
G5	4629	Bd Sustain
G#5	5401	Sd D&B1
A5	4607	Bd Break2
A#5	5427	Sd Dist
B5	4630	Bd TekPower
C6	4615	Bd Distortion RM

Groove Organ

Note	Wave Number	Wave Name
C0	4441	Bd Jazz1-2St
C#0	5226	Sd Brush Soft R
D0	5239	Sd Brush SwirAtt St
D#0	5227	Sd Brush Med St
E0	5239	Sd Brush SwirAtt St
F0	5212	Sd LiveRoll St
F#0	2860	Castanet1
G0	4930	Sd Hip 1St
G#0	2855	Stick1
A0	4408	Bd Funk 1 L
A#0	4917	Sd Tight 3St
B0	4450	Bd FK Jazz St
C1	4403	Bd Funk St1-2
C#1	5198	Sd Closed Rim St
D1	4830	Sd Funk 1St
D#1	5206	Sd RockRoll St
E1	4894	Sd BluesHeart St1-3
F1	5887	Tom Floor St
F#1	5614	HH Power ClTip 1-4St
G1	5887	Tom Floor St
G#1	5654	HH Power ClPedal St
A1	5883	Tom Low St
A#1	5658	HH Power Open EdgeSt
B1	5879	Tom Mid St
C2	5879	Tom Mid St
C#2	6175	Crash2 St
D2	5875	Tom Hi St
D#2	6229	Ride2 St
E2	6283	China1 St
F2	6282	Ride Cup Mono2
F#2	2845	Tambourine1 Hit
G2	6293	Splash1 St
G#2	3223	Cowbell1
A2	6175	Crash2 St
A#2	2879	Vibraslap1
B2	6225	Ride1 St
C3	2979	Bongo1 Hi 1Fingr 1-2
C#3	2992	Bongo1 Lo 3Fingr 1-2
D3	2922	Conga1 Hi Tip
D#3	2928	Conga1 Hi Slap Open
E3	2926	Conga1 Hi Open 2
F3	3027	Timbale1 Hi 1
F#3	3027	Timbale1 Hi 1
G3	3106	Agogo1 Lo
G#3	3106	Agogo1 Lo
A3	3063	Cabasa1A 1
A#3	3059	Maracas1 Slur
B3	5226	Sd Brush Soft R
C4	5236	Sd Brush Swir St
C#4	3113	Guiro1 Short
D4	3112	Guiro1 Long
D#4	3219	Claves3
E4	2872	Wood Block
F4	2872	Wood Block
F#4	3034	Timbale1 Paila H
G4	3035	Timbale1 Paila L
G#4	2884	Triangle1 Mute
A4	2883	Triangle1 Open
A#4	2818	Shaker A 2
B4	2908	Sleigh Bell1
C5	2912	Wind Chime 1
C#5	4886	Sd Blues L1-3
D5	4841	Sd Funk Ay St
D#5	4902	Sd BluesHeart R1-3
E5	4880	Sd Blues St1-2
F5	4416	Bd Low L
F#5	5177	Sd LdwHmono
G5	4434	Bd Dry2
G#5	5239	Sd Brush SwirAtt St
A5	4604	Bd Hip Deep
A#5	5215	Sd Roll Mono
B5	4402	Bd Normal 2R
C6	6214	Crash Brush2 St

ScotsAccordion MMM

Note	Wave Number	Wave Name
C0	4441	Bd Jazz1-2St
C#0	5226	Sd Brush Soft R
D0	5239	Sd Brush SwirAtt St
D#0	5227	Sd Brush Med St
E0	5239	Sd Brush SwirAtt St
F0	5212	Sd LiveRoll St
F#0	2860	Castanet1
G0	4934	Sd Hip 1L
G#0	2855	Stick1
A0	4408	Bd Funk 1 L
A#0	4917	Sd Tight 3St
B0	4450	Bd FK Jazz St
C1	4450	Bd FK Jazz St
C#1	5198	Sd Closed Rim St
D1	5231	Sd Brush vari L
D#1	2848	Tambourine2 Hit
E1	5184	Sd Rock Stick1 R
F1	5887	Tom Floor St
F#1	5614	HH Power ClTip 1-4St
G1	5887	Tom Floor St
G#1	5654	HH Power ClPedal St
A1	5883	Tom Low St
A#1	5658	HH Power Open EdgeSt
B1	5879	Tom Mid St
C2	5879	Tom Mid St
C#2	6175	Crash2 St
D2	5875	Tom Hi St
D#2	6229	Ride2 St
E2	6283	China1 St
F2	6282	Ride Cup Mono2
F#2	2845	Tambourine1 Hit
G2	6293	Splash1 St
G#2	3223	Cowbell1
A2	6175	Crash2 St
A#2	2879	Vibraslap1
B2	6225	Ride1 St
C3	2979	Bongo1 Hi 1Fingr 1-2
C#3	2992	Bongo1 Lo 3Fingr 1-2
D3	2922	Conga1 Hi Tip
D#3	2928	Conga1 Hi Slap Open
E3	2926	Conga1 Hi Open 2
F3	3027	Timbale1 Hi 1
F#3	3027	Timbale1 Hi 1
G3	3106	Agogo1 Lo
G#3	3106	Agogo1 Lo
A3	3063	Cabasa1A 1
A#3	3059	Maracas1 Slur
B3	5226	Sd Brush Soft R
C4	5236	Sd Brush Swir St
C#4	3113	Guiro1 Short
D4	3112	Guiro1 Long
D#4	3217	Claves1
E4	2872	Wood Block
F4	2872	Wood Block
F#4	3034	Timbale1 Paila H
G4	3035	Timbale1 Paila L
G#4	2884	Triangle1 Mute
A4	2883	Triangle1 Open
A#4	2818	ShakerA 2
B4	2908	Sleigh Bell1
C5	2912	Wind Chime 1
C#5	4886	Sd Blues L1-3
D5	4840	Sd Funk 3R
D#5	4902	Sd BluesHeart R1-3
E5	4880	Sd Blues St1-2
F5	4416	Bd Low L
F#5	5177	Sd LdwHMono
G5	4434	Bd Dry2
G#5	5239	Sd Brush SwirAtt St
A5	4604	Bd Hip Deep
A#5	5215	Sd Roll Mono
B5	4402	Bd Normal 2R
C6	6214	Crash Brush2 St

Songwriter 2015

Note	Wave Number	Wave Name
C0	5457	Sd TB Comp1
C#0	5456	Sd TB Q
D0	2531	Abstract Fx1
D#0	2534	Abstract Fx4
E0	2537	Damage Fx1
F0	2536	Bazer Fx
F#0	2539	Damage Fx3
G0	2532	Abstract Fx2
G#0	2563	Electric Fx Perc8
A0	4685	Bd Body2
A#0	5451	Sd ShortDry2
B0	4682	Bd LongBass
C1	4680	Bd EDM10
C#1	5452	Sd ShortGate1
D1	5456	Sd TB Q
D#1	4190	RX11 Clap
E1	5445	Sd Clap1
F1	6138	Comp EleTom Low
F#1	5820	HH TecClosed1
G1	6138	Comp EleTom Low
G#1	5822	HH TecClosed2
A1	6138	Comp EleTom Low
A#1	5823	HH TecOpen2
B1	6137	Comp EleTom High
C2	6137	Comp EleTom High
C#2	6199	PI Crash 15
D2	6137	Comp EleTom High
D#2	6262	Fine Ride Bow
E2	6292	China4
F2	6264	Fine Ride Cup
F#2	3088	Pandeiro1 Tip
G2	6200	PI Crash 16
G#2	2513	Hi Q2
A2	6200	PI Crash 16
A#2	2513	Hi Q2
B2	6263	Fine Ride Edge
C3	2790	Acoustic Bass FX07
C#3	2281	Mini Brip6
D3	2276	Mini Brip1
D#3	2277	Mini Brip2
E3	2967	Quinto1 Slap
F3	3288	Tabla1 Bya
F#3	3272	Djembe1 Edge
G3	3289	Tabla1 Nah
G#3	3545	Barasim Tak
A3	4188	Electric Clap1
A#3	2509	Electric Perc13
B3	2392	Hop FX1
C4	2550	Noize Fx1
C#4	2552	Noize Rize1
D4	2553	Noize Rize2
D#4	2533	Abstract Fx3
E4	2535	Abstract Fx5
F4	4286	Analog Click
F#4	5780	HH Closed T8-1
G4	5431	Sd FM
G#4	5570	HH Half Open2 RL
A4	4276	Claves T8-1
A#4	5781	HH Open T8-1
B4	6346	Reverse Cymbal1
C5	4558	Bd DanceGate1
C#5	4681	Bd EDM Gate
D5	4559	Bd DanceGate2
D#5	2547	Damage Fx11
E5	4662	Bd Stack3
F5	4680	Bd EDM10
F#5	5178	Sd BreakRim
G5	2570	Electric Fx Perc15
G#5	2551	Noize Fx2
A5	2544	Damage Fx8
A#5	2561	Electric Fx Perc6
B5	2559	Electric Fx Perc4
C6	2564	Electric Fx Perc9

French Br ED

Note	Wave Number	Wave Name
C1	4700	House BD 1 St
D1	4210	Electro Clap 2 St
F#1	5522	HH Closed 1L

1 Finger Gangster

Note	Wave Number	Wave Name
C0	3217	Claves1
C#0	3149	Cajon1 Kick
D0	3150	Cajon1 Slap
D#0	3151	Cajon1 Tip 1-2
E0	3217	Claves1
F0	2872	Wood Block
F#0	2889	Hand Clap1 St
G0	6230	Ride2 L
G#0	4230	HipHop Snap2
A0	2860	Castanet1
A#0	2284	Voc Beat The Band
B0	2520	Mega Complexro6
C1	2924	Conga1 Hi Open 1-2
C#1	2927	Conga1 Hi Mute
D1	4358	HipHop Smack St
D#1	2929	Conga1 Hi Slap
E1	4358	HipHop Smack St
F1	2933	Conga1 Lo Tip
F#1	2934	Conga1 Lo Heel
G1	2935	Conga1 Lo Open 1-2
G#1	2938	Conga1 Lo Mute
A1	2939	Conga1 Lo Slap Open
A#1	2939	Conga1 Lo Slap Open
B1	2936	Conga1 Lo Open 1
C2	2979	Bongo1 Hi 1Fingr 1-2
C#2	2982	Bongo1 Hi 3Fingr 1-2
D2	2985	Bongo1 Hi Rim
D#2	2986	Bongo1 Hi Tip
E2	2987	Bongo1 Hi Heel
F2	4354	Electro Misc 11 St
F#2	2989	Bongo1 Lo 1Fingr 1-2
G2	2992	Bongo1 Lo 3Fingr 1-2
G#2	4312	Dub Misc 08 St
A2	2996	Bongo1 Lo Tip
A#2	2992	Bongo1 Lo 3Fingr 1-2
B2	2988	Bongo1 Hi Slap
C3	3030	Timbale1 Lo 1-2
C#3	2967	Quinto1 Slap
D3	2966	Quinto1 Open
D#3	2922	Conga1 Hi Tip
E3	2970	Tumba Open
F3	4255	Elec Shaker3 St
F#3	3026	Timbale1 Hi 1-3
G3	3086	Pandeiro1 Open
G#3	3087	Pandeiro1 Thump
A3	3088	Pandeiro1 Tip
A#3	3089	Pandeiro1 Heel
B3	3052	Paila H
C4	3224	Cowbell2
C#4	3224	Cowbell2
D4	3105	Agogo1 Hi
D#4	3105	Agogo1 Hi
E4	3113	Guiro1 Short
F4	3112	Guiro1 Long
F#4	3118	MetalGuiro Short 1-2
G4	3121	MetalGuiro Long
G#4	2843	Tambourine1 Sw
A4	3102	Tmbourim Open
A#4	4345	Electro Misc 02 St
B4	3103	Tmbourim Finger
C5	3058	Maracas1 Sw
C#5	2816	ShakerA 13
D5	3062	Cabasa1A 1-2
D#5	2974	Cuica1 Lo
E5	2975	Cuica1 Hi
F5	3223	Cowbell1
F#5	3236	Mambo Bell Body
G5	3440	Shekere Down
G#5	3442	Shekere Slap
A5	2884	Triangle1 Mute
A#5	2883	Triangle1 Open
B5	3220	Whistle
C6	2912	Wind Chime 1

1 Finger Gangster

Note	Wave Number	Wave Name
C0	5457	Sd TB Comp1
C#0	5456	Sd TB Q
D0	2531	Abstract Fx1
D#0	2546	Damage Fx10
E0	2537	Damage Fx1
F0	2536	Bazer Fx
F#0	2539	Damage Fx3
G0	2532	Abstract Fx2
G#0	4868	Sd SonA 4St
A0	4685	Bd Body2
A#0	5789	T8 HHOp 4
B0	4682	Bd LongBass
C1	4723	HipHop BD 3 Mn
C#1	5452	Sd ShortGate1
D1	5506	Sd HipHop Rim2
D#1	4190	RX11 Clap
E1	5445	Sd Clap1
F1	5506	Sd HipHop Rim2
F#1	5820	HH TecClosed1
G1	6138	Comp EleTom Low
G#1	5822	HH TecClosed2
A1	6138	Comp EleTom Low
A#1	5823	HH TecOpen2
B1	6137	Comp EleTom High
C2	6137	Comp EleTom High
C#2	6199	PI Crash 15
D2	6137	Comp EleTom High
D#2	6262	Fine Ride Bow
E2	6292	China4
F2	6264	Fine Ride Cup
F#2	3088	Pandeiro1 Tip
G2	6200	PI Crash 16
G#2	2513	Hi Q2
A2	6200	PI Crash 16
A#2	2513	Hi Q2
B2	6263	Fine Ride Edge
C3	2790	Acoustic Bass FX07
C#3	2281	Mini Brip6
D3	2276	Mini Brip1
D#3	2277	Mini Brip2
E3	2967	Quinto1 Slap
F3	3288	Tabla1 Bya
F#3	3272	Djembe1 Edge
G3	3289	Tabla1 Nah
G#3	3545	Barasim Tak
A3	4188	Electric Clap1
A#3	2829	Std Shaker
B3	2392	Hop FX1
C4	2550	Noize Fx1
C#4	2552	Noize Rize1
D4	2553	Noize Rize2
D#4	2533	Abstract Fx3
E4	2535	Abstract Fx5
F4	4286	Analog Click
F#4	5780	HH Closed T8-1
G4	5431	Sd FM
G#4	5570	HH Half Open2 RL
A4	4276	Claves T8-1
A#4	5781	HH Open T8-1
B4	6346	Reverse Cymbal1
C5	4558	Bd DanceGate1
C#5	4681	Bd EDM Gate
D5	4559	Bd DanceGate2
D#5	5475	EDM SD 6 Mn
E5	4662	Bd Stack3
F5	4680	Bd EDM10
F#5	5178	Sd BreakRim
G5	2570	Electric Fx Perc15
G#5	2551	Noize Fx2
A5	2544	Damage Fx8
A#5	2561	Electric Fx Perc6
B5	2559	Electric Fx Perc4
C6	2564	Electric Fx Perc9

Rock Star

Note	Wave Number	Wave Name
C0	3217	Claves1
C#0	5224	Sd Brush Soft St
D0	5236	Sd Brush Swir St
D#0	5227	Sd Brush Med St
E0	5239	Sd Brush SwirAtt St
F0	5212	Sd LiveRoll St
F#0	2860	Castanet1
G0	4812	Sd Normal 1St
G#0	2855	Stick1
A0	4424	Bd Funk Son St
A#0	4844	Sd Basic St1-3
B0	4368	Bd Snap 1
C1	4418	Bd H Son St
C#1	5198	Sd Closed Rim St
D1	4859	Sd SonA St1-4
D#1	4179	Clap T9-1
E1	4909	Sd Tight St1-4
F1	5887	Tom Floor St
F#1	5563	HH Closed Foot St
G1	5887	Tom Floor St
G#1	5567	HH Half Open2 St
A1	5883	Tom Low St
A#1	5571	HH Open2 St
B1	5883	Tom Low St
C2	5879	Tom Mid St
C#2	6178	Crash2 RL
D2	5875	Tom Hi St
D#2	6225	Ride1 St
E2	6283	China1 St
F2	6237	Ride Brite Cup St
F#2	2843	Tambourine1 Sw
G2	6293	Splash1 St
G#2	3224	Cowbell2
A2	6178	Crash2 RL
A#2	2879	Vibraslap1
B2	6228	Ride1 RL
C3	2979	Bongo1 Hi 1Fingr 1-2
C#3	2992	Bongo1 Lo 3Fingr 1-2
D3	2922	Conga1 Hi Tip
D#3	2926	Conga1 Hi Open 2
E3	2970	Tumba Open
F3	3026	Timbale1 Hi 1-3
F#3	3030	Timbale1 Lo 1-2
G3	3105	Agogo1 Hi
G#3	3106	Agogo1 Lo
A3	3062	Cabasa1A 1-2
A#3	3059	Maracas1 Slur
B3	3220	Whistle
C4	3220	Whistle
C#4	3113	Guiro1 Short
D4	3112	Guiro1 Long
D#4	3217	Claves1
E4	2872	Wood Block
F4	2872	Wood Block
F#4	2975	Cuica1 Hi
G4	2974	Cuica1 Lo
G#4	2884	Triangle1 Mute
A4	2883	Triangle1 Open
A#4	2817	Shaker A 1
B4	2908	Sleigh Bell1
C5	2912	Wind Chime 1
C#5	4726	Sd Bld St1-4
D5	4879	Sd Blues St1-3
D#5	4902	Sd BluesHeart R1-3
E5	4929	Sd Hip St1-2
F5	4806	Sd Normal St1-4
F#5	5177	Sd LdwHMMono
G5	4747	Sd Soul St1-3
G#5	5180	Sd Heavy
A5	4830	Sd Funk 1St
A#5	4395	Bd Normal 1St
B5	4424	Bd Funk Son St
C6	4367	Bd Snap 1-2

Dub Rock Bass

Note	Wave Number	Wave Name
B0	4688	Dub BD 2 St
C1	4690	Dub BD 4 Mn
C#1	5419	Sd Break3
D1	5462	Dub SD 4 Mn
D#1	4195	Dub Clap St
E1	5417	Sd Break1
F1	6139	Dub Tom Mn
F#1	5828	Trap HH 1 St
G1	5486	Flam Mn
G#1	5824	Dub HH 1 Mn
A1	4689	Dub BD 3 Mn
A#1	5826	Dub OHH 1 St
B1	4687	Dub BD 1 Mn
C2	4691	Dub BD 5 St
C#2	4690	Dub BD 4 Mn
D2	4305	Dub Misc 01 St
D#2	6334	Dub Ride St
E2	2574	Dub Fx1 Mn
F2	2575	Dub Fx2 St
F#2	4262	Electric Tambourine3
G2	4263	Electric Tambourine4
G#2	4306	Dub Misc 02 St
A2	4308	Dub Misc 04 St
A#2	4307	Dub Misc 03 St
B2	5838	Trap OHH 2 St
C3	4309	Dub Misc 05 St
C#3	4310	Dub Misc 06 St
D3	4314	Dub Misc 10 St
D#3	4315	Trap Misc 1 St
E3	4313	Dub Misc 09 St
F3	4314	Dub Misc 10 St
F#3	4692	Dub BD 6 St
G3	4360	Tick 01 St
G#3	2653	HipHop Scratch2 St
A3	4253	Elec Shaker1 St
A#3	4254	Elec Shaker2 St
B3	4255	Elec Shaker3 St
C4	4256	Elec Shaker4 St
C#4	4257	Elec Shaker5 St
D4	4357	Rattle Mn
D#4	5461	Dub SD 3 Mn
E4	4267	Elec Wood Block1 St
F4	4269	Elec Wood Block3 St
F#4	4268	Elec Wood Block2 St
G4	4270	Elec Wood Block4 St
G#4	5462	Dub SD 4 Mn
A4	5463	Dub SD 5 St

Dub Rock Bass

Note	Wave Number	Wave Name
C0	5457	Sd TB Comp1
C#0	5456	Sd TB Q
D0	2531	Abstract Fx1
D#0	2534	Abstract Fx4
E0	2537	Damage Fx1
F0	2536	Bazer Fx
F#0	2539	Damage Fx3
G0	5784	T8 HHCl
G#0	2563	Electric Fx Perc8
A0	4685	Bd Body2
A#0	5451	Sd ShortDry2
B0	4682	Bd LongBass
C1	4662	Bd Stack3
C#1	5452	Sd ShortGate1
D1	5456	Sd TB Q
D#1	4190	RX11 Clap
E1	5445	Sd Clap1
F1	6138	Comp EleTom Low
F#1	5506	Sd HipHop Rim2
G1	6138	Comp EleTom Low
G#1	5766	HH Closed T9
A1	6138	Comp EleTom Low
A#1	5823	HH TecOpen2
B1	6137	Comp EleTom High
C2	6137	Comp EleTom High
C#2	6199	PI Crash 15
D2	6137	Comp EleTom High
D#2	6262	Fine Ride Bow
E2	6292	China4
F2	6264	Fine Ride Cup
F#2	3088	Pandeiro1 Tip
G2	6200	PI Crash 16
G#2	2513	Hi Q2
A2	6200	PI Crash 16
A#2	2513	Hi Q2
B2	6263	Fine Ride Edge
C3	2790	Acoustic Bass FX07
C#3	2281	Mini Brip6
D3	2276	Mini Brip1
D#3	2277	Mini Brip2
E3	2967	Quinto1 Slap
F3	3288	Tabla1 Bya
F#3	3272	Djembe1 Edge
G3	3289	Tabla1 Nah
G#3	3545	Barasim Tak
A3	4188	Electric Clap1
A#3	2509	Electric Perc13
B3	2392	Hop FX1
C4	2550	Noize Fx1
C#4	2552	Noize Rize1
D4	2553	Noize Rize2
D#4	2533	Abstract Fx3
E4	2535	Abstract Fx5
F4	4286	Analog Click
F#4	5780	HH Closed T8-1
G4	5431	Sd FM
G#4	5570	HH Half Open2 RL
A4	4276	Claves T8-1
A#4	5781	HH Open T8-1
B4	6346	Reverse Cymbal1
C5	4558	Bd DanceGate1
C#5	4681	Bd EDM Gate
D5	4559	Bd DanceGate2
D#5	2547	Damage Fx11
E5	4662	Bd Stack3
F5	4680	Bd EDM10
F#5	5178	Sd BreakRim
G5	2570	Electric Fx Perc15
G#5	2551	Noize Fx2
A5	2544	Damage Fx8
A#5	2561	Electric Fx Perc6
B5	2559	Electric Fx Perc4
C6	2564	Electric Fx Perc9

Tektonic Dub

Note	Wave Number	Wave Name
C0	5457	Sd TB Comp1
C#0	5456	Sd TB Q
D0	2531	Abstract Fx1
D#0	2534	Abstract Fx4
E0	2537	Damage Fx1
F0	2536	Bazer Fx
F#0	2539	Damage Fx3
G0	5784	T8 HHCl
G#0	2563	Electric Fx Perc8
A0	4685	Bd Body2
A#0	5451	Sd ShortDry2
B0	4682	Bd LongBass
C1	4683	Bd Body1 Hard
C#1	5452	Sd ShortGate1
D1	5456	Sd TB Q
D#1	4190	RX11 Clap
E1	5445	Sd Clap1
F1	6138	Comp EleTom Low
F#1	5506	Sd HipHop Rim2
G1	6138	Comp EleTom Low
G#1	5766	HH Closed T9
A1	6138	Comp EleTom Low
A#1	5823	HH TecOpen2
B1	6137	Comp EleTom High
C2	6137	Comp EleTom High
C#2	6199	PI Crash 15
D2	6137	Comp EleTom High
D#2	6262	Fine Ride Bow
E2	6292	China4
F2	6264	Fine Ride Cup
F#2	3088	Pandeiro1 Tip
G2	6200	PI Crash 16
G#2	2513	Hi Q2
A2	6200	PI Crash 16
A#2	2513	Hi Q2
B2	6263	Fine Ride Edge
C3	2790	Acoustic Bass FX07
C#3	2281	Mini Brip6
D3	2276	Mini Brip1
D#3	2277	Mini Brip2
E3	2967	Quinto1 Slap
F3	3288	Tabla1 Bya
F#3	3272	Djembe1 Edge
G3	3289	Tabla1 Nah
G#3	3545	Barasim Tak
A3	4188	Electric Clap1
A#3	2509	Electric Perc13
B3	2392	Hop FX1
C4	2550	Noize Fx1
C#4	2552	Noize Rize1
D4	2553	Noize Rize2
D#4	2533	Abstract Fx3
E4	2535	Abstract Fx5
F4	4286	Analog Click
F#4	5780	HH Closed T8-1
G4	5431	Sd FM
G#4	5570	HH Half Open2 RL
A4	4276	Claves T8-1
A#4	5781	HH Open T8-1
B4	6346	Reverse Cymbal1
C5	4558	Bd DanceGate1
C#5	4681	Bd EDM Gate
D5	4559	Bd DanceGate2
D#5	2547	Damage Fx11
E5	4662	Bd Stack3
F5	4680	Bd EDM10
F#5	5178	Sd BreakRim
G5	2570	Electric Fx Perc15
G#5	2551	Noize Fx2
A5	2544	Damage Fx8
A#5	2561	Electric Fx Perc6
B5	2559	Electric Fx Perc4
C6	2564	Electric Fx Perc9

Tektonic Dub

Note	Wave Number	Wave Name
B0	4688	Dub BD 2 St
C1	4690	Dub BD 4 Mn
C#1	5419	Sd Break3
D1	5462	Dub SD 4 Mn
D#1	4195	Dub Clap St
E1	5417	Sd Break1
F1	6139	Dub Tom Mn
F#1	5828	Trap HH 1 St
G1	5486	Flam Mn
G#1	5824	Dub HH 1 Mn
A1	4689	Dub BD 3 Mn
A#1	5826	Dub OHH 1 St
B1	4687	Dub BD 1 Mn
C2	4691	Dub BD 5 St
C#2	4690	Dub BD 4 Mn
D2	4305	Dub Misc 01 St
D#2	6334	Dub Ride St
E2	2574	Dub Fx1 Mn
F2	2575	Dub Fx2 St
F#2	4262	Electric Tambourine3
G2	4263	Electric Tambourine4
G#2	4306	Dub Misc 02 St
A2	4308	Dub Misc 04 St
A#2	4307	Dub Misc 03 St
B2	5838	Trap OHH 2 St
C3	4309	Dub Misc 05 St
C#3	4310	Dub Misc 06 St
D3	4314	Dub Misc 10 St
D#3	4315	Trap Misc 1 St
E3	4313	Dub Misc 09 St
F3	4314	Dub Misc 10 St
F#3	4692	Dub BD 6 St
G3	4360	Tick 01 St
G#3	2653	HipHop Scratch2 St
A3	4253	Elec Shaker1 St
A#3	4254	Elec Shaker2 St
B3	4255	Elec Shaker3 St
C4	4256	Elec Shaker4 St
C#4	4257	Elec Shaker5 St
D4	4357	Rattle Mn
D#4	5461	Dub SD 3 Mn
E4	4267	Elec Wood Block1 St
F4	4269	Elec Wood Block3 St
F#4	4268	Elec Wood Block2 St
G4	4270	Elec Wood Block4 St
G#4	5462	Dub SD 4 Mn
A4	5463	Dub SD 5 St

Tektonic Dub

Note	Wave Number	Wave Name
C0	5457	Sd TB Comp1
C#0	5456	Sd TB Q
D0	2531	Abstract Fx1
D#0	2534	Abstract Fx4
E0	2537	Damage Fx1
F0	2536	Bazer Fx
F#0	2539	Damage Fx3
G0	5784	T8 HHCl
G#0	2563	Electric Fx Perc8
A0	4685	Bd Body2
A#0	5451	Sd ShortDry2
B0	4682	Bd LongBass
C1	4662	Bd Stack3
C#1	5452	Sd ShortGate1
D1	5456	Sd TB Q
D#1	4190	RX11 Clap
E1	5445	Sd Clap1
F1	6138	Comp EleTom Low
F#1	5506	Sd HipHop Rim2
G1	6138	Comp EleTom Low
G#1	5766	HH Closed T9
A1	6138	Comp EleTom Low
A#1	5823	HH TecOpen2
B1	6137	Comp EleTom High
C2	6137	Comp EleTom High
C#2	6199	PI Crash 15
D2	6137	Comp EleTom High
D#2	6262	Fine Ride Bow
E2	6292	China4
F2	6264	Fine Ride Cup
F#2	3088	Pandeiro1 Tip
G2	6200	PI Crash 16
G#2	2513	Hi Q2
A2	6200	PI Crash 16
A#2	2513	Hi Q2
B2	6263	Fine Ride Edge
C3	2790	Acoustic Bass FX07
C#3	2281	Mini Brip6
D3	2276	Mini Brip1
D#3	2277	Mini Brip2
E3	2967	Quinto1 Slap
F3	3288	Tabla1 Bya
F#3	3272	Djembe1 Edge
G3	3289	Tabla1 Nah
G#3	3545	Barasim Tak
A3	4188	Electric Clap1
A#3	2509	Electric Perc13
B3	2392	Hop FX1
C4	2550	Noize Fx1
C#4	2552	Noize Rize1
D4	2553	Noize Rize2
D#4	2533	Abstract Fx3
E4	2535	Abstract Fx5
F4	4286	Analog Click
F#4	5780	HH Closed T8-1
G4	5431	Sd FM
G#4	5570	HH Half Open2 RL
A4	4276	Claves T8-1
A#4	5781	HH Open T8-1
B4	6346	Reverse Cymbal1
C5	4558	Bd DanceGate1
C#5	4681	Bd EDM Gate
D5	4559	Bd DanceGate2
D#5	2547	Damage Fx11
E5	4662	Bd Stack3
F5	4680	Bd EDM10
F#5	5178	Sd BreakRim
G5	2570	Electric Fx Perc15
G#5	2551	Noize Fx2
A5	2544	Damage Fx8
A#5	2561	Electric Fx Perc6
B5	2559	Electric Fx Perc4
C6	2564	Electric Fx Perc9

Tektonic Dub

Note	Wave Number	Wave Name
C0	5457	Sd TB Comp1
C#0	5456	Sd TB Q
D0	2531	Abstract Fx1
D#0	2534	Abstract Fx4
E0	2537	Damage Fx1
F0	2536	Bazer Fx
F#0	2539	Damage Fx3
G0	5784	T8 HHCl
G#0	2563	Electric Fx Perc8
A0	4685	Bd Body2
A#0	5451	Sd ShortDry2
B0	4682	Bd LongBass
C1	4662	Bd Stack3
C#1	5452	Sd ShortGate1
D1	5456	Sd TB Q
D#1	4190	RX11 Clap
E1	5445	Sd Clap1
F1	6138	Comp EleTom Low
F#1	5504	Sd HipHop16
G1	6138	Comp EleTom Low
G#1	5822	HH TecClosed2
A1	6138	Comp EleTom Low
A#1	5823	HH TecOpen2
B1	6137	Comp EleTom High
C2	6137	Comp EleTom High
C#2	6199	PI Crash 15
D2	6137	Comp EleTom High
D#2	6262	Fine Ride Bow
E2	6292	China4
F2	6264	Fine Ride Cup
F#2	3088	Pandeiro1 Tip
G2	6200	PI Crash 16
G#2	2513	Hi Q2
A2	6200	PI Crash 16
A#2	2513	Hi Q2
B2	6263	Fine Ride Edge
C3	2790	Acoustic Bass FX07
C#3	2281	Mini Brip6
D3	2276	Mini Brip1
D#3	2277	Mini Brip2
E3	2967	Quinto1 Slap
F3	3288	Tabla1 Bya
F#3	3272	Djembe1 Edge
G3	3289	Tabla1 Nah
G#3	3545	Barasim Tak
A3	4188	Electric Clap1
A#3	2509	Electric Perc13
B3	2392	Hop FX1
C4	2550	Noize Fx1
C#4	2552	Noize Rize1
D4	2553	Noize Rize2
D#4	2533	Abstract Fx3
E4	2535	Abstract Fx5
F4	4286	Analog Click
F#4	5780	HH Closed T8-1
G4	5431	Sd FM
G#4	5570	HH Half Open2 RL
A4	4276	Claves T8-1
A#4	5781	HH Open T8-1
B4	6346	Reverse Cymbal1
C5	4558	Bd DanceGate1
C#5	4681	Bd EDM Gate
D5	4559	Bd DanceGate2
D#5	2547	Damage Fx11
E5	4662	Bd Stack3
F5	4680	Bd EDM10
F#5	5178	Sd BreakRim
G5	2570	Electric Fx Perc15
G#5	2551	Noize Fx2
A5	2544	Damage Fx8
A#5	2561	Electric Fx Perc6
B5	2559	Electric Fx Perc4
C6	2564	Electric Fx Perc9

Slow and Steady

Note	Wave Number	Wave Name
C1	4700	House BD 1 St

EDM PiTch Bomb

Note	Wave Number	Wave Name
C0	5457	Sd TB Comp1
C#0	5456	Sd TB Q
D0	2531	Abstract Fx1
D#0	2534	Abstract Fx4
E0	2537	Damage Fx1
F0	2536	Bazer Fx
F#0	2539	Damage Fx3
G0	5784	T8 HHCl
G#0	2563	Electric Fx Perc8
A0	4685	Bd Body2
A#0	5451	Sd ShortDry2
B0	4682	Bd LongBass
C1	4662	Bd Stack3
C#1	5452	Sd ShortGate1
D1	5456	Sd TB Q
D#1	4190	RX11 Clap
E1	5445	Sd Clap1
F1	6138	Comp EleTom Low
F#1	5506	Sd HipHop Rim2
G1	6138	Comp EleTom Low
G#1	5780	HH Closed T8-1
A1	6138	Comp EleTom Low
A#1	5823	HH TecOpen2
B1	6137	Comp EleTom High
C2	6137	Comp EleTom High
C#2	6199	PI Crash 15
D2	6137	Comp EleTom High
D#2	6262	Fine Ride Bow
E2	6292	China4
F2	6264	Fine Ride Cup
F#2	3088	Pandeiro1 Tip
G2	6200	PI Crash 16
G#2	2513	Hi Q2
A2	6200	PI Crash 16
A#2	2513	Hi Q2
B2	6263	Fine Ride Edge
C3	2790	Acoustic Bass FX07
C#3	2281	Mini Brip6
D3	2276	Mini Brip1
D#3	2277	Mini Brip2
E3	2967	Quinto1 Slap
F3	3288	Tabla1 Bya
F#3	3272	Djembe1 Edge
G3	3289	Tabla1 Nah
G#3	3545	Barasim Tak
A3	4188	Electric Clap1
A#3	2509	Electric Perc13
B3	2392	Hop FX1
C4	2550	Noize Fx1
C#4	2552	Noize Rize1
D4	2553	Noize Rize2
D#4	2533	Abstract Fx3
E4	2535	Abstract Fx5
F4	4286	Analog Click
F#4	5780	HH Closed T8-1
G4	5431	Sd FM
G#4	5570	HH Half Open2 RL
A4	4276	Claves T8-1
A#4	5781	HH Open T8-1
B4	6346	Reverse Cymbal1
C5	4558	Bd DanceGate1
C#5	4681	Bd EDM Gate
D5	4559	Bd DanceGate2
D#5	2547	Damage Fx11
E5	4662	Bd Stack3
F5	4680	Bd EDM10
F#5	5178	Sd BreakRim
G5	2570	Electric Fx Perc15
G#5	2551	Noize Fx2
A5	2544	Damage Fx8
A#5	2561	Electric Fx Perc6
B5	2559	Electric Fx Perc4
C6	2564	Electric Fx Perc9

EDM PiTch Bomb

Note	Wave Number	Wave Name
C0	5457	Sd TB Comp1
C#0	5456	Sd TB Q
D0	2531	Abstract Fx1
D#0	2534	Abstract Fx4
E0	2537	Damage Fx1
F0	2536	Bazer Fx
F#0	2539	Damage Fx3
G0	5784	T8 HHCl
G#0	2563	Electric Fx Perc8
A0	4685	Bd Body2
A#0	5451	Sd ShortDry2
B0	4682	Bd LongBass
C1	4662	Bd Stack3
C#1	5452	Sd ShortGate1
D1	5456	Sd TB Q
D#1	4190	RX11 Clap
E1	5445	Sd Clap1
F1	6138	Comp EleTom Low
F#1	5504	Sd HipHop16
G1	6138	Comp EleTom Low
G#1	5822	HH TecClosed2
A1	6138	Comp EleTom Low
A#1	5823	HH TecOpen2
B1	6137	Comp EleTom High
C2	6137	Comp EleTom High
C#2	6199	PI Crash 15
D2	6137	Comp EleTom High
D#2	6262	Fine Ride Bow
E2	6292	China4
F2	6264	Fine Ride Cup
F#2	3088	Pandeiro1 Tip
G2	6200	PI Crash 16
G#2	2513	Hi Q2
A2	6200	PI Crash 16
A#2	2513	Hi Q2
B2	6263	Fine Ride Edge
C3	2790	Acoustic Bass FX07
C#3	2281	Mini Brip6
D3	2276	Mini Brip1
D#3	2277	Mini Brip2
E3	2967	Quinto1 Slap
F3	3288	Tabla1 Bya
F#3	3272	Djembe1 Edge
G3	3289	Tabla1 Nah
G#3	3545	Barasim Tak
A3	4188	Electric Clap1
A#3	2509	Electric Perc13
B3	2392	Hop FX1
C4	2550	Noize Fx1
C#4	2552	Noize Rize1
D4	2553	Noize Rize2
D#4	2533	Abstract Fx3
E4	2535	Abstract Fx5
F4	4286	Analog Click
F#4	5780	HH Closed T8-1
G4	5431	Sd FM
G#4	5570	HH Half Open2 RL
A4	4276	Claves T8-1
A#4	5781	HH Open T8-1
B4	6346	Reverse Cymbal1
C5	4558	Bd DanceGate1
C#5	4681	Bd EDM Gate
D5	4559	Bd DanceGate2
D#5	2547	Damage Fx11
E5	4662	Bd Stack3
F5	4680	Bd EDM10
F#5	5178	Sd BreakRim
G5	2570	Electric Fx Perc15
G#5	2551	Noize Fx2
A5	2544	Damage Fx8
A#5	2561	Electric Fx Perc6
B5	2559	Electric Fx Perc4
C6	2564	Electric Fx Perc9

Soft and Dirty FM

Note	Wave Number	Wave Name
C1	4663	Bd Stack4
F#1	5780	HH Closed T8-1

Kool FM Disco Lead

Note	Wave Number	Wave Name
C0	4671	Bd EDM01
C#0	5393	Sd AnCR
D0	5353	Sd T9-5
D#0	4190	RX11 Clap
E0	5354	Sd T9Gate
F0	5206	Sd RockRoll St
F#0	5351	Sd T9-3
G0	5352	Sd T9-4
G#0	5354	Sd T9Gate
A0	4563	Bd T9-4
A#0	5353	Sd T9-5
B0	4560	Bd T9-1
C1	4680	Bd EDM10
C#1	5355	Sd T9Rim
D1	5349	Sd T9-1
D#1	4179	Clap T9-1
E1	5350	Sd T9-2
F1	6107	Tom T9 Lo
F#1	5795	HH Closed RX11
G1	6107	Tom T9 Lo
G#1	5767	HH Open T9
A1	6107	Tom T9 Lo
A#1	5767	HH Open T9
B1	6106	Tom T9 Hi
C2	6106	Tom T9 Hi
C#2	6303	Crash T9-1
D2	6106	Tom T9 Hi
D#2	4247	Cowbell RX11
E2	6287	China2
F2	6281	Ride Cup Mono
F#2	4258	Tambourine RX5
G2	6179	Crash3
G#2	3223	Cowbell1
A2	6180	Crash4
A#2	4242	Cowbell T8
B2	6231	Ride2 R
C3	4231	Conga T8
C#3	4231	Conga T8
D3	2922	Conga1 Hi Tip
D#3	2928	Conga1 Hi Slap Open
E3	2926	Conga1 Hi Open 2
F3	3026	Timbale1 Hi 1-3
F#3	3030	Timbale1 Lo 1-2
G3	4286	Analog Click
G#3	4231	Conga T8
A3	3062	Cabasa1A 1-2
A#3	3059	Maracas1 Slur
B3	2613	FxGun2
C4	2612	FxGun1
C#4	2629	Scratch H
D4	2631	Scratch Down
D#4	2512	Hi Q1
E4	2512	Hi Q1
F4	2513	Hi Q2
F#4	2630	Scratch L
G4	2630	Scratch L
G#4	2884	Triangle1 Mute
A4	2883	Triangle1 Open
A#4	4250	Analog Shaker
B4	2908	Sleigh Bell1
C5	2912	Wind Chime 1
C#5	4959	Sd Piccolo
D5	5380	Sd T8-5
D#5	5209	Sd RockRollD St
E5	5227	Sd Brush Med St
F5	4596	Bd BlpHd
F#5	5397	Sd Jungle1
G5	4629	Bd Sustain
G#5	5401	Sd D&B1
A5	4607	Bd Break2
A#5	5427	Sd Dist
B5	4630	Bd TekPower
C6	4615	Bd Distortion RM

Arcade

Note	Wave Number	Wave Name
C0	5457	Sd TB Comp1
C#0	5456	Sd TB Q
D0	2531	Abstract Fx1
D#0	2534	Abstract Fx4
E0	2537	Damage Fx1
F0	2536	Bazer Fx
F#0	2539	Damage Fx3
G0	5784	T8 HHCl
G#0	2563	Electric Fx Perc8
A0	4685	Bd Body2
A#0	5451	Sd ShortDry2
B0	4682	Bd LongBass
C1	4662	Bd Stack3
C#1	5452	Sd ShortGate1
D1	5455	Sd TB Gate
D#1	4190	RX11 Clap
E1	5445	Sd Clap1
F1	6138	Comp EleTom Low
F#1	5504	Sd HipHop16
G1	6138	Comp EleTom Low
G#1	5822	HH TecClosed2
A1	6138	Comp EleTom Low
A#1	5823	HH TecOpen2
B1	6137	Comp EleTom High
C2	6137	Comp EleTom High
C#2	6199	PI Crash 15
D2	6137	Comp EleTom High
D#2	6262	Fine Ride Bow
E2	6292	China4
F2	6264	Fine Ride Cup
F#2	3088	Pandeiro1 Tip
G2	6200	PI Crash 16
G#2	2513	Hi Q2
A2	6200	PI Crash 16
A#2	2513	Hi Q2
B2	6263	Fine Ride Edge
C3	2790	Acoustic Bass FX07
C#3	2281	Mini Brip6
D3	2276	Mini Brip1
D#3	2277	Mini Brip2
E3	2967	Quinto1 Slap
F3	3288	Tabla1 Bya
F#3	3272	Djembe1 Edge
G3	3289	Tabla1 Nah
G#3	3545	Barasim Tak
A3	4188	Electric Clap1
A#3	2509	Electric Perc13
B3	2392	Hop FX1
C4	2550	Noize Fx1
C#4	2552	Noize Rize1
D4	2553	Noize Rize2
D#4	2533	Abstract Fx3
E4	2535	Abstract Fx5
F4	4286	Analog Click
F#4	5780	HH Closed T8-1
G4	5431	Sd FM
G#4	5570	HH Half Open2 RL
A4	4276	Claves T8-1
A#4	5781	HH Open T8-1
B4	6346	Reverse Cymbal1
C5	4558	Bd DanceGate1
C#5	4681	Bd EDM Gate
D5	4559	Bd DanceGate2
D#5	2547	Damage Fx11
E5	4662	Bd Stack3
F5	4680	Bd EDM10
F#5	5178	Sd BreakRim
G5	2570	Electric Fx Perc15
G#5	2551	Noize Fx2
A5	2544	Damage Fx8
A#5	2561	Electric Fx Perc6
B5	2559	Electric Fx Perc4
C6	2564	Electric Fx Perc9

Chillomatik

Note	Wave Number	Wave Name
C0	4580	Bd T8-1
C#0	5381	Sd T8 Rim
D0	5377	Sd T8-2
D#0	4188	Electric Clap1
E0	5326	Sd Elec11
F0	5322	Sd Elec7
F#0	5379	Sd T8-4
G0	4638	Bd Elec2
G#0	5376	Sd T8-1
A0	4715	Bd HipHop8
A#0	5378	Sd T8-3
B0	4716	Bd HipHop9
C1	4682	Bd LongBass
C#1	5393	Sd AnCR
D1	5492	Sd HipHop4
D#1	4187	Clap AnSm
E1	5493	Sd HipHop5
F1	6123	Tom T8
F#1	5780	HH Closed T8-1
G1	6123	Tom T8
G#1	5781	HH Open T8-1
A1	6123	Tom T8
A#1	5781	HH Open T8-1
B1	6123	Tom T8
C2	6123	Tom T8
C#2	6179	Crash3
D2	6123	Tom T8
D#2	6329	Ride T9-1
E2	6293	Splash1 St
F2	6281	Ride Cup Mono
F#2	2845	Tambourine1 Hit
G2	6305	Crash T8-1
G#2	4242	Cowbell T8
A2	6283	China1 St
A#2	4242	Cowbell T8
B2	6225	Ride1 St
C3	4231	Conga T8
C#3	4231	Conga T8
D3	4231	Conga T8
D#3	4231	Conga T8
E3	4231	Conga T8
F3	2929	Conga1 Hi Slap
F#3	2928	Conga1 Hi Slap Open
G3	2926	Conga1 Hi Open 2
G#3	3027	Timbale1 Hi 1
A3	3064	Cabasa1A 2
A#3	3059	Maracas1 Slur
B3	2297	Voc Infinity
C4	2417	Portamento Lead Seq
C#4	2505	Electric Perc9
D4	2825	Shaker Hip1
D#4	4276	Claves T8-1
E4	2512	Hi Q1
F4	2513	Hi Q2
F#4	2826	Shaker Hip2
G4	2511	Electric Perc15
G#4	2884	Triangle1 Mute
A4	2883	Triangle1 Open
A#4	2828	Shaker Hip4
B4	2489	Ripper
C5	4640	Bd Elec4
C#5	2523	Granular Loop1
D5	2438	Epic Fx Loop4
D#5	5321	Sd Elec6
E5	5490	Sd HipHop2
F5	4646	Bd ElecGate
F#5	5782	HH Closed T8-2
G5	4635	Bd ThickSkin
G#5	5783	HH Open T8-2
A5	4608	Bd Break Heavy
A#5	5783	HH Open T8-2
B5	4605	Bd Break Deep
C6	4603	Bd R&B2

PITCh Up Vowel Pad

Note	Wave Number	Wave Name
C1	4671	Bd EDM01
F#1	5780	HH Closed T8-1

EDM Fun 2

Note	Wave Number	Wave Name
C1	4668	Bd TB Comp
D1	4186	Elec T8 Clap

EDM Fun 1

Note	Wave Number	Wave Name
C1	4655	Bd Hybrid2
D1	5456	Sd TB Q

Schlager Herz

Note	Wave Number	Wave Name
C0	5457	Sd TB Comp1
C#0	5456	Sd TB Q
D0	2531	Abstract Fx1
D#0	2534	Abstract Fx4
E0	2537	Damage Fx1
F0	2536	Bazer Fx
F#0	2539	Damage Fx3
G0	2532	Abstract Fx2
G#0	2563	Electric Fx Perc8
A0	4688	Dub BD 2 St
A#0	5451	Sd ShortDry2
B0	4688	Dub BD 2 St
C1	4688	Dub BD 2 St
C#1	5452	Sd ShortGate1
D1	5456	Sd TB Q
D#1	4190	RX11 Clap
E1	5445	Sd Clap1
F1	6138	Comp EleTom Low
F#1	5830	Trap HH 3 St
G1	6138	Comp EleTom Low
G#1	5822	HH TecClosed2
A1	6138	Comp EleTom Low
A#1	5819	HH OpenNine
B1	6137	Comp EleTom High
C2	6137	Comp EleTom High
C#2	6199	PI Crash 15
D2	6137	Comp EleTom High
D#2	6262	Fine Ride Bow
E2	6292	China4
F2	6264	Fine Ride Cup
F#2	3088	Pandeiro1 Tip
G2	6200	PI Crash 16
G#2	2513	Hi Q2
A2	6200	PI Crash 16
A#2	2513	Hi Q2
B2	6338	Electro Ride Mn
C3	2790	Acoustic Bass FX07
C#3	2281	Mini Brip6
D3	2844	Tambourine1 Shake
D#3	2277	Mini Brip2
E3	2967	Quinto1 Slap
F3	3288	Tabla1 Bya
F#3	3272	Djembe1 Edge
G3	3289	Tabla1 Nah
G#3	3545	Barasim Tak
A3	4188	Electric Clap1
A#3	2820	ShakerB Sw
B3	2392	Hop FX1
C4	2550	Noize Fx1
C#4	2552	Noize Rize1
D4	2553	Noize Rize2
D#4	2533	Abstract Fx3
E4	2535	Abstract Fx5
F4	4286	Analog Click
F#4	5780	HH Closed T8-1
G4	5431	Sd FM
G#4	5570	HH Half Open2 RL
A4	4276	Claves T8-1
A#4	5781	HH Open T8-1
B4	6346	Reverse Cymbal1
C5	4558	Bd DanceGate1
C#5	4681	Bd EDM Gate
D5	4559	Bd DanceGate2
D#5	2547	Damage Fx11
E5	4662	Bd Stack3
F5	4680	Bd EDM10
F#5	5178	Sd BreakRim
G5	2570	Electric Fx Perc15
G#5	2551	Noize Fx2
A5	2544	Damage Fx8
A#5	2561	Electric Fx Perc6
B5	2559	Electric Fx Perc4
C6	2564	Electric Fx Perc9

Mr. Side Chain

Note	Wave Number	Wave Name
C0	5457	Sd TB Comp1
C#0	5456	Sd TB Q
D0	2531	Abstract Fx1
D#0	2534	Abstract Fx4
E0	2537	Damage Fx1
F0	2536	Bazer Fx
F#0	2539	Damage Fx3
G0	2532	Abstract Fx2
G#0	2563	Electric Fx Perc8
A0	4685	Bd Body2
A#0	5451	Sd ShortDry2
B0	4682	Bd LongBass
C1	4705	Electro BD 2 Mn
C#1	5452	Sd ShortGate1
D1	5447	Sd Clap3
D#1	4190	RX11 Clap
E1	5445	Sd Clap1
F1	6138	Comp EleTom Low
F#1	5817	HH ClosedNine
G1	6138	Comp EleTom Low
G#1	5818	HH PedalNine
A1	6138	Comp EleTom Low
A#1	5819	HH OpenNine
B1	6137	Comp EleTom High
C2	6137	Comp EleTom High
C#2	6199	PI Crash 15
D2	6137	Comp EleTom High
D#2	6262	Fine Ride Bow
E2	6292	China4
F2	6264	Fine Ride Cup
F#2	3088	Pandeiro1 Tip
G2	6200	PI Crash 16
G#2	2513	Hi Q2
A2	6200	PI Crash 16
A#2	2513	Hi Q2
B2	6263	Fine Ride Edge
C3	2790	Acoustic Bass FX07
C#3	2281	Mini Brip6
D3	2276	Mini Brip1
D#3	2277	Mini Brip2
E3	2967	Quinto1 Slap
F3	3288	Tabla1 Bya
F#3	3272	Djembe1 Edge
G3	3289	Tabla1 Nah
G#3	3545	Barasim Tak
A3	4188	Electric Clap1
A#3	2509	Electric Perc13
B3	2392	Hop FX1
C4	2550	Noize Fx1
C#4	2552	Noize Rize1
D4	2553	Noize Rize2
D#4	2533	Abstract Fx3
E4	2535	Abstract Fx5
F4	4286	Analog Click
F#4	5780	HH Closed T8-1
G4	5431	Sd FM
G#4	5570	HH Half Open2 RL
A4	4276	Claves T8-1
A#4	5781	HH Open T8-1
B4	6346	Reverse Cymbal1
C5	4558	Bd DanceGate1
C#5	4681	Bd EDM Gate
D5	4559	Bd DanceGate2
D#5	2547	Damage Fx11
E5	4662	Bd Stack3
F5	4680	Bd EDM10
F#5	5178	Sd BreakRim
G5	2570	Electric Fx Perc15
G#5	2551	Noize Fx2
A5	2544	Damage Fx8
A#5	2561	Electric Fx Perc6
B5	2559	Electric Fx Perc4
C6	2564	Electric Fx Perc9

Mr. Side Chain

Note	Wave Number	Wave Name
C0	5457	Sd TB Comp1
C#0	5456	Sd TB Q
D0	2531	Abstract Fx1
D#0	2534	Abstract Fx4
E0	2537	Damage Fx1
F0	2536	Bazer Fx
F#0	2539	Damage Fx3
G0	2532	Abstract Fx2
G#0	2563	Electric Fx Perc8
A0	4685	Bd Body2
A#0	5451	Sd ShortDry2
B0	4682	Bd LongBass
C1	4698	EDM BD 4 Mn
C#1	5452	Sd ShortGate1
D1	5447	Sd Clap3
D#1	4190	RX11 Clap
E1	5445	Sd Clap1
F1	6138	Comp EleTom Low
F#1	5817	HH ClosedNine
G1	6138	Comp EleTom Low
G#1	5818	HH PedalNine
A1	6138	Comp EleTom Low
A#1	5819	HH OpenNine
B1	6137	Comp EleTom High
C2	6137	Comp EleTom High
C#2	6199	PI Crash 15
D2	6137	Comp EleTom High
D#2	6262	Fine Ride Bow
E2	6292	China4
F2	6264	Fine Ride Cup
F#2	3088	Pandeiro1 Tip
G2	6200	PI Crash 16
G#2	2513	Hi Q2
A2	6200	PI Crash 16
A#2	2513	Hi Q2
B2	6263	Fine Ride Edge
C3	2790	Acoustic Bass FX07
C#3	2281	Mini Brip6
D3	2276	Mini Brip1
D#3	2277	Mini Brip2
E3	2967	Quinto1 Slap
F3	3288	Tabla1 Bya
F#3	3272	Djembe1 Edge
G3	3289	Tabla1 Nah
G#3	3545	Barasim Tak
A3	4188	Electric Clap1
A#3	2509	Electric Perc13
B3	2392	Hop FX1
C4	2550	Noize Fx1
C#4	2552	Noize Rize1
D4	2553	Noize Rize2
D#4	2533	Abstract Fx3
E4	2535	Abstract Fx5
F4	4286	Analog Click
F#4	5780	HH Closed T8-1
G4	5431	Sd FM
G#4	5570	HH Half Open2 RL
A4	4276	Claves T8-1
A#4	5781	HH Open T8-1
B4	6346	Reverse Cymbal1
C5	4558	Bd DanceGate1
C#5	4681	Bd EDM Gate
D5	4559	Bd DanceGate2
D#5	2547	Damage Fx11
E5	4662	Bd Stack3
F5	4680	Bd EDM10
F#5	5178	Sd BreakRim
G5	2570	Electric Fx Perc15
G#5	2551	Noize Fx2
A5	2544	Damage Fx8
A#5	2561	Electric Fx Perc6
B5	2559	Electric Fx Perc4
C6	2564	Electric Fx Perc9

Chart Topper

Note	Wave Number	Wave Name
C1	4688	Dub BD 2 St
D1	5401	Sd D&B1
F#1	5836	Trap HH 9 St

Travel Frontiers

Note	Wave Number	Wave Name
C0	4561	Bd T9-2
C#0	5392	Sd AnSm Rim
D0	5324	Sd Elec9
D#0	4187	Clap AnSm
E0	5322	Sd Elec7
F0	5326	Sd Elec11
F#0	5322	Sd Elec7
G0	5376	Sd T8-1
G#0	5353	Sd T9-5
A0	4565	Bd T9 Hd2
A#0	5327	Sd Elec12
B0	4566	Bd T9 Hd3
C1	4631	Bd Hard Long
C#1	5355	Sd T9Rim
D1	5320	Sd Elec5
D#1	4179	Clap T9-1
E1	5350	Sd T9-2
F1	5433	Sd Syn
F#1	5766	HH Closed T9
G1	5433	Sd Syn
G#1	5767	HH Open T9
A1	5433	Sd Syn
A#1	5767	HH Open T9
B1	5433	Sd Syn
C2	5433	Sd Syn
C#2	6303	Crash T9-1
D2	5433	Sd Syn
D#2	6329	Ride T9-1
E2	6310	Crash Syn
F2	6281	Ride Cup Mono
F#2	2845	Tambourine1 Hit
G2	6305	Crash T8-1
G#2	4242	Cowbell T8
A2	6283	China1 St
A#2	4242	Cowbell T8
B2	6225	Ride1 St
C3	2979	Bongo1 Hi 1Fingr 1-2
C#3	2992	Bongo1 Lo 3Fingr 1-2
D3	2929	Conga1 Hi Slap
D#3	2928	Conga1 Hi Slap Open
E3	2926	Conga1 Hi Open 2
F3	6131	Tom Syn1
F#3	6131	Tom Syn1
G3	4286	Analog Click
G#3	2494	Noise Burst
A3	3064	Cabasa1A 2
A#3	3059	Maracas1 Slur
B3	2397	Neo Seq Em-3
C4	2413	Neo Seq2 Em-5
C#4	2497	Electric Perc1
D4	2825	Shaker Hip1
D#4	4276	Claves T8-1
E4	4258	Tambourine RX5
F4	4247	Cowbell RX11
F#4	2826	Shaker Hip2
G4	2506	Electric Perc10
G#4	2884	Triangle1 Mute
A4	2883	Triangle1 Open
A#4	2828	Shaker Hip4
B4	2496	Zap2
C5	4715	Bd HipHop8
C#5	4564	Bd T9 Hd1
D5	4643	Bd ElecComp3
D#5	4560	Bd T9-1
E5	4566	Bd T9 Hd3
F5	4631	Bd Hard Long
F#5	5780	HH Closed T8-1
G5	4642	Bd ElecComp2
G#5	5783	HH Open T8-2
A5	4564	Bd T9 Hd1
A#5	5781	HH Open T8-1
B5	4565	Bd T9 Hd2
C6	4643	Bd ElecComp3

Honeyfaces

Note	Wave Number	Wave Name
C1	4623	Crackle BD St
D1	5335	Fresh Snare 2

Breathless Safri

Note	Wave Number	Wave Name
C0	5457	Sd TB Comp1
C#0	5456	Sd TB Q
D0	2531	Abstract Fx1
D#0	2534	Abstract Fx4
E0	2537	Damage Fx1
F0	2536	Bazer Fx
F#0	2539	Damage Fx3
G0	2532	Abstract Fx2
G#0	2563	Electric Fx Perc8
A0	4688	Dub BD 2 St
A#0	5451	Sd ShortDry2
B0	4688	Dub BD 2 St
C1	4692	Dub BD 6 St
C#1	5452	Sd ShortGate1
D1	5456	Sd TB Q
D#1	4190	RX11 Clap
E1	5445	Sd Clap1
F1	6138	Comp EleTom Low
F#1	5830	Trap HH 3 St
G1	6138	Comp EleTom Low
G#1	5822	HH TecClosed2
A1	6138	Comp EleTom Low
A#1	5819	HH OpenNine
B1	6137	Comp EleTom High
C2	6137	Comp EleTom High
C#2	6199	PI Crash 15
D2	6137	Comp EleTom High
D#2	6262	Fine Ride Bow
E2	6292	China4
F2	6264	Fine Ride Cup
F#2	3088	Pandeiro1 Tip
G2	6200	PI Crash 16
G#2	2513	Hi Q2
A2	6200	PI Crash 16
A#2	2513	Hi Q2
B2	6338	Electro Ride Mn
C3	2790	Acoustic Bass FX07
C#3	2281	Mini Brip6
D3	2844	Tambourine1 Shake
D#3	2277	Mini Brip2
E3	2967	Quinto1 Slap
F3	3288	Tabla1 Bya
F#3	3272	Djembe1 Edge
G3	3289	Tabla1 Nah
G#3	3545	Barasim Tak
A3	4188	Electric Clap1
A#3	2820	ShakerB Sw
B3	2392	Hop FX1
C4	2550	Noize Fx1
C#4	2552	Noize Rize1
D4	2553	Noize Rize2
D#4	2533	Abstract Fx3
E4	2535	Abstract Fx5
F4	4286	Analog Click
F#4	5780	HH Closed T8-1
G4	5431	Sd FM
G#4	5570	HH Half Open2 RL
A4	4276	Claves T8-1
A#4	5781	HH Open T8-1
B4	6346	Reverse Cymbal1
C5	4558	Bd DanceGate1
C#5	4681	Bd EDM Gate
D5	4559	Bd DanceGate2
D#5	2547	Damage Fx11
E5	4662	Bd Stack3
F5	4680	Bd EDM10
F#5	5178	Sd BreakRim
G5	2570	Electric Fx Perc15
G#5	2551	Noize Fx2
A5	2544	Damage Fx8
A#5	2561	Electric Fx Perc6
B5	2559	Electric Fx Perc4
C6	2564	Electric Fx Perc9

Schlager Weapon 2

Note	Wave Number	Wave Name
C0	5457	Sd TB Comp1
C#0	5456	Sd TB Q
D0	2531	Abstract Fx1
D#0	2534	Abstract Fx4
E0	2537	Damage Fx1
F0	2536	Bazer Fx
F#0	2539	Damage Fx3
G0	2532	Abstract Fx2
G#0	2563	Electric Fx Perc8
A0	4688	Dub BD 2 St
A#0	5451	Sd ShortDry2
B0	4688	Dub BD 2 St
C1	4688	Dub BD 2 St
C#1	5452	Sd ShortGate1
D1	5456	Sd TB Q
D#1	4190	RX11 Clap
E1	5445	Sd Clap1
F1	6138	Comp EleTom Low
F#1	5830	Trap HH 3 St
G1	6138	Comp EleTom Low
G#1	5822	HH TecClosed2
A1	6138	Comp EleTom Low
A#1	5819	HH OpenNine
B1	6137	Comp EleTom High
C2	6137	Comp EleTom High
C#2	6199	PI Crash 15
D2	6137	Comp EleTom High
D#2	6262	Fine Ride Bow
E2	6292	China4
F2	6264	Fine Ride Cup
F#2	3088	Pandeiro1 Tip
G2	6200	PI Crash 16
G#2	2513	Hi Q2
A2	6200	PI Crash 16
A#2	2513	Hi Q2
B2	6338	Electro Ride Mn
C3	2790	Acoustic Bass FX07
C#3	2281	Mini Brip6
D3	2844	Tambourine1 Shake
D#3	2277	Mini Brip2
E3	2967	Quinto1 Slap
F3	3288	Tabla1 Bya
F#3	3272	Djembe1 Edge
G3	3289	Tabla1 Nah
G#3	3545	Barasim Tak
A3	4188	Electric Clap1
A#3	2820	ShakerB Sw
B3	2392	Hop FX1
C4	2550	Noize Fx1
C#4	2552	Noize Rize1
D4	2553	Noize Rize2
D#4	2533	Abstract Fx3
E4	2535	Abstract Fx5
F4	4286	Analog Click
F#4	5780	HH Closed T8-1
G4	5431	Sd FM
G#4	5570	HH Half Open2 RL
A4	4276	Claves T8-1
A#4	5781	HH Open T8-1
B4	6346	Reverse Cymbal1
C5	4558	Bd DanceGate1
C#5	4681	Bd EDM Gate
D5	4559	Bd DanceGate2
D#5	2547	Damage Fx11
E5	4662	Bd Stack3
F5	4680	Bd EDM10
F#5	5178	Sd BreakRim
G5	2570	Electric Fx Perc15
G#5	2551	Noize Fx2
A5	2544	Damage Fx8
A#5	2561	Electric Fx Perc6
B5	2559	Electric Fx Perc4
C6	2564	Electric Fx Perc9

Kool Dis Comp

Note	Wave Number	Wave Name
C0	4671	Bd EDM01
C#0	5393	Sd AnCR
D0	5353	Sd T9-5
D#0	4190	RX11 Clap
E0	5354	Sd T9Gate
F0	5206	Sd RockRoll St
F#0	5351	Sd T9-3
G0	5352	Sd T9-4
G#0	5354	Sd T9Gate
A0	4563	Bd T9-4
A#0	5353	Sd T9-5
B0	4560	Bd T9-1
C1	4680	Bd EDM10
C#1	5355	Sd T9Rim
D1	5349	Sd T9-1
D#1	4179	Clap T9-1
E1	5350	Sd T9-2
F1	6107	Tom T9 Lo
F#1	5795	HH Closed RX11
G1	6107	Tom T9 Lo
G#1	5767	HH Open T9
A1	6107	Tom T9 Lo
A#1	5767	HH Open T9
B1	6106	Tom T9 Hi
C2	6106	Tom T9 Hi
C#2	6303	Crash T9-1
D2	6106	Tom T9 Hi
D#2	4247	Cowbell RX11
E2	6287	China2
F2	6281	Ride Cup Mono
F#2	4258	Tambourine RX5
G2	6179	Crash3
G#2	3223	Cowbell1
A2	6180	Crash4
A#2	4242	Cowbell T8
B2	6231	Ride2 R
C3	4231	Conga T8
C#3	4231	Conga T8
D3	2922	Conga1 Hi Tip
D#3	2928	Conga1 Hi Slap Open
E3	2926	Conga1 Hi Open 2
F3	3026	Timbale1 Hi 1-3
F#3	3030	Timbale1 Lo 1-2
G3	4286	Analog Click
G#3	4231	Conga T8
A3	3062	Cabasa1A 1-2
A#3	3059	Maracas1 Slur
B3	2613	FxGun2
C4	2612	FxGun1
C#4	2629	Scratch H
D4	2631	Scratch Down
D#4	2512	Hi Q1
E4	2512	Hi Q1
F4	2513	Hi Q2
F#4	2630	Scratch L
G4	2630	Scratch L
G#4	2884	Triangle1 Mute
A4	2883	Triangle1 Open
A#4	4250	Analog Shaker
B4	2908	Sleigh Bell1
C5	2912	Wind Chime 1
C#5	4959	Sd Piccolo
D5	5380	Sd T8-5
D#5	5209	Sd RockRollD St
E5	5227	Sd Brush Med St
F5	4596	Bd BlpHd
F#5	5397	Sd Jungle1
G5	4629	Bd Sustain
G#5	5401	Sd D&B1
A5	4607	Bd Break2
A#5	5427	Sd Dist
B5	4630	Bd TekPower
C6	4615	Bd Distortion RM

Saws Vs Bells

Note	Wave Number	Wave Name
C0	5457	Sd TB Comp1
C#0	5456	Sd TB Q
D0	2531	Abstract Fx1
D#0	2534	Abstract Fx4
E0	2537	Damage Fx1
F0	2536	Bazer Fx
F#0	2539	Damage Fx3
G0	2532	Abstract Fx2
G#0	2563	Electric Fx Perc8
A0	4685	Bd Body2
A#0	5451	Sd ShortDry2
B0	4682	Bd LongBass
C1	4707	Electro BD 4 St
C#1	5452	Sd ShortGate1
D1	5456	Sd TB Q
D#1	4190	RX11 Clap
E1	5445	Sd Clap1
F1	6138	Comp EleTom Low
F#1	5820	HH TecClosed1
G1	6138	Comp EleTom Low
G#1	5822	HH TecClosed2
A1	6138	Comp EleTom Low
A#1	5823	HH TecOpen2
B1	6137	Comp EleTom High
C2	6137	Comp EleTom High
C#2	6199	PI Crash 15
D2	6137	Comp EleTom High
D#2	6262	Fine Ride Bow
E2	6292	China4
F2	6264	Fine Ride Cup
F#2	3088	Pandeiro1 Tip
G2	6200	PI Crash 16
G#2	2513	Hi Q2
A2	6200	PI Crash 16
A#2	2513	Hi Q2
B2	6263	Fine Ride Edge
C3	2790	Acoustic Bass FX07
C#3	2281	Mini Brip6
D3	2276	Mini Brip1
D#3	2277	Mini Brip2
E3	2967	Quinto1 Slap
F3	3288	Tabla1 Bya
F#3	3272	Djembe1 Edge
G3	3289	Tabla1 Nah
G#3	3545	Barasim Tak
A3	4188	Electric Clap1
A#3	2509	Electric Perc13
B3	2392	Hop FX1
C4	2550	Noize Fx1
C#4	2552	Noize Rize1
D4	2553	Noize Rize2
D#4	2533	Abstract Fx3
E4	2535	Abstract Fx5
F4	4286	Analog Click
F#4	5780	HH Closed T8-1
G4	5431	Sd FM
G#4	5570	HH Half Open2 RL
A4	4276	Claves T8-1
A#4	5781	HH Open T8-1
B4	6346	Reverse Cymbal1
C5	4558	Bd DanceGate1
C#5	4681	Bd EDM Gate
D5	4559	Bd DanceGate2
D#5	2547	Damage Fx11
E5	4662	Bd Stack3
F5	4680	Bd EDM10
F#5	5178	Sd BreakRim
G5	2570	Electric Fx Perc15
G#5	2551	Noize Fx2
A5	2544	Damage Fx8
A#5	2561	Electric Fx Perc6
B5	2559	Electric Fx Perc4
C6	2564	Electric Fx Perc9

FM Comper

Note	Wave Number	Wave Name
C1	4671	Bd EDM01
F#1	5780	HH Closed T8-1

Schlager Weapon 3

Note	Wave Number	Wave Name
C0	5457	Sd TB Comp1
C#0	5456	Sd TB Q
D0	2531	Abstract Fx1
D#0	2534	Abstract Fx4
E0	2537	Damage Fx1
F0	2536	Bazer Fx
F#0	2539	Damage Fx3
G0	2532	Abstract Fx2
G#0	2563	Electric Fx Perc8
A0	4688	Dub BD 2 St
A#0	5451	Sd ShortDry2
B0	4688	Dub BD 2 St
C1	4688	Dub BD 2 St
C#1	5452	Sd ShortGate1
D1	5456	Sd TB Q
D#1	4190	RX11 Clap
E1	5445	Sd Clap1
F1	6138	Comp EleTom Low
F#1	5830	Trap HH 3 St
G1	6138	Comp EleTom Low
G#1	5822	HH TecClosed2
A1	6138	Comp EleTom Low
A#1	5819	HH OpenNine
B1	6137	Comp EleTom High
C2	6137	Comp EleTom High
C#2	6199	PI Crash 15
D2	6137	Comp EleTom High
D#2	6262	Fine Ride Bow
E2	6292	China4
F2	6264	Fine Ride Cup
F#2	3088	Pandeiro1 Tip
G2	6200	PI Crash 16
G#2	2513	Hi Q2
A2	6200	PI Crash 16
A#2	2513	Hi Q2
B2	6338	Electro Ride Mn
C3	2790	Acoustic Bass FX07
C#3	2281	Mini Brip6
D3	2844	Tambourine1 Shake
D#3	2277	Mini Brip2
E3	2967	Quinto1 Slap
F3	3288	Tabla1 Bya
F#3	3272	Djembe1 Edge
G3	3289	Tabla1 Nah
G#3	3545	Barasim Tak
A3	4188	Electric Clap1
A#3	2820	ShakerB Sw
B3	2392	Hop FX1
C4	2550	Noize Fx1
C#4	2552	Noize Rize1
D4	2553	Noize Rize2
D#4	2533	Abstract Fx3
E4	2535	Abstract Fx5
F4	4286	Analog Click
F#4	5780	HH Closed T8-1
G4	5431	Sd FM
G#4	5570	HH Half Open2 RL
A4	4276	Claves T8-1
A#4	5781	HH Open T8-1
B4	6346	Reverse Cymbal1
C5	4558	Bd DanceGate1
C#5	4681	Bd EDM Gate
D5	4559	Bd DanceGate2
D#5	2547	Damage Fx11
E5	4662	Bd Stack3
F5	4680	Bd EDM10
F#5	5178	Sd BreakRim
G5	2570	Electric Fx Perc15
G#5	2551	Noize Fx2
A5	2544	Damage Fx8
A#5	2561	Electric Fx Perc6
B5	2559	Electric Fx Perc4
C6	2564	Electric Fx Perc9

Caramel Ice

Note	Wave Number	Wave Name
C0	2446	LFO Seq
C#0	2321	Trance Choir
D0	3431	Tibetan Bowl
D#0	2642	Scratch Stop
E0	2465	Fx Female Voice St
F0	2380	Stab Organ2
F#0	4351	Electro Misc 08 St
G0	2445	Radio Noise
G#0	2618	Door Squeak
A0	2789	Acoustic Bass FX06
A#0	2794	Electric Bass FX 02
B0	2789	Acoustic Bass FX06
C1	4596	Bd BlpHd
C#1	4595	Bd Brip
D1	5411	Sd Hip Gate
D#1	4859	Sd SonA St1-4
E1	2494	Noise Burst
F1	6135	Tom Dist Lo
F#1	5766	HH Closed T9
G1	6134	Tom Dist Hi
G#1	5517	HH Closed 2St
A1	6106	Tom T9 Hi
A#1	5767	HH Open T9
B1	6106	Tom T9 Hi
C2	6106	Tom T9 Hi
C#2	6283	China1 St
D2	6106	Tom T9 Hi
D#2	6293	Splash1 St
E2	6303	Crash T9-1
F2	6329	Ride T9-1
F#2	3088	Pandeiro1 Tip
G2	4260	Electric Tambourine 1
G#2	2513	Hi Q2
A2	4556	Bd Gate
A#2	2513	Hi Q2
B2	2786	Acoustic Bass FX03
C3	2784	Acoustic Bass FX01
C#3	2281	Mini Brip6
D3	2276	Mini Brip1
D#3	2277	Mini Brip2
E3	2967	Quinto1 Slap
F3	3288	Tabla1 Bya
F#3	3272	Djembe1 Edge
G3	3289	Tabla1 Nah
G#3	3545	Barasim Tak
A3	2504	Electric Perc8
A#3	2509	Electric Perc13
B3	2392	Hop FX1
C4	2341	Motion Beam
C#4	2496	Zap2
D4	2480	Digi Voice Mod
D#4	1909	Human Whistle
E4	2479	Digital Wind
F4	4286	Analog Click
F#4	5780	HH Closed T8-1
G4	5431	Sd FM
G#4	5570	HH Half Open2 RL
A4	4276	Claves T8-1
A#4	5781	HH Open T8-1
B4	6346	Reverse Cymbal1
C5	4632	Bd Analog Tight
C#5	4643	Bd ElecComp3
D5	4566	Bd T9 Hd3
D#5	4627	Bd ZapHard
E5	4636	Bd Slimy
F5	4609	Bd Break Hard
F#5	5178	Sd BreakRim
G5	4747	Sd Soul St1-3
G#5	4964	Sd Ambience
A5	4943	Sd Rock Mute1 R
A#5	5428	Sd Cut
B5	5403	Sd D&B3
C6	5422	Sd FX1

DJ Montage

Note	Wave Number	Wave Name
C0	5457	Sd TB Comp1
C#0	5456	Sd TB Q
D0	2531	Abstract Fx1
D#0	2534	Abstract Fx4
E0	2537	Damage Fx1
F0	2536	Bazer Fx
F#0	2539	Damage Fx3
G0	2532	Abstract Fx2
G#0	2563	Electric Fx Perc8
A0	4685	Bd Body2
A#0	5451	Sd ShortDry2
B0	4682	Bd LongBass
C1	4673	Bd EDM03
C#1	5452	Sd ShortGate1
D1	5447	Sd Clap3
D#1	4190	RX11 Clap
E1	5445	Sd Clap1
F1	6138	Comp EleTom Low
F#1	5817	HH ClosedNine
G1	6138	Comp EleTom Low
G#1	5818	HH PedalNine
A1	6138	Comp EleTom Low
A#1	5819	HH OpenNine
B1	6137	Comp EleTom High
C2	6137	Comp EleTom High
C#2	6199	PI Crash 15
D2	6137	Comp EleTom High
D#2	6262	Fine Ride Bow
E2	6292	China4
F2	6264	Fine Ride Cup
F#2	3088	Pandeiro1 Tip
G2	6200	PI Crash 16
G#2	2513	Hi Q2
A2	6200	PI Crash 16
A#2	2513	Hi Q2
B2	6263	Fine Ride Edge
C3	2790	Acoustic Bass FX07
C#3	2281	Mini Brip6
D3	2276	Mini Brip1
D#3	2277	Mini Brip2
E3	2967	Quinto1 Slap
F3	3288	Tabla1 Bya
F#3	3272	Djembe1 Edge
G3	3289	Tabla1 Nah
G#3	3545	Barasim Tak
A3	4188	Electric Clap1
A#3	2509	Electric Perc13
B3	2392	Hop FX1
C4	2550	Noize Fx1
C#4	2552	Noize Rize1
D4	2553	Noize Rize2
D#4	2533	Abstract Fx3
E4	2535	Abstract Fx5
F4	4286	Analog Click
F#4	5780	HH Closed T8-1
G4	5431	Sd FM
G#4	5570	HH Half Open2 RL
A4	4276	Claves T8-1
A#4	5781	HH Open T8-1
B4	6346	Reverse Cymbal1
C5	4558	Bd DanceGate1
C#5	4681	Bd EDM Gate
D5	4559	Bd DanceGate2
D#5	2547	Damage Fx11
E5	4662	Bd Stack3
F5	4680	Bd EDM10
F#5	5178	Sd BreakRim
G5	2570	Electric Fx Perc15
G#5	2551	Noize Fx2
A5	2544	Damage Fx8
A#5	2561	Electric Fx Perc6
B5	2559	Electric Fx Perc4
C6	2564	Electric Fx Perc9

DNA Lounge

Note	Wave Number	Wave Name
C0	4580	Bd T8-1
C#0	5393	Sd AnCR
D0	5379	Sd T8-4
D#0	5426	Sd Clap Analog
E0	5378	Sd T8-3
F0	6123	Tom T8
F#0	5380	Sd T8-5
G0	4582	Bd T8-3
G#0	5379	Sd T8-4
A0	4581	Bd T8-2
A#0	5378	Sd T8-3
B0	2256	T8 Kick Bass
C1	4581	Bd T8-2
C#1	5381	Sd T8 Rim
D1	5377	Sd T8-2
D#1	4179	Clap T9-1
E1	5376	Sd T8-1
F1	6123	Tom T8
F#1	5782	HH Closed T8-2
G1	6123	Tom T8
G#1	5781	HH Open T8-1
A1	6123	Tom T8
A#1	5781	HH Open T8-1
B1	6123	Tom T8
C2	6123	Tom T8
C#2	6305	Crash T8-1
D2	6123	Tom T8
D#2	6329	Ride T9-1
E2	6287	China2
F2	6281	Ride Cup Mono
F#2	4258	Tambourine RX5
G2	6295	Splash1 R
G#2	4242	Cowbell T8
A2	6180	Crash4
A#2	2879	Vibraslap1
B2	6231	Ride2 R
C3	4231	Conga T8
C#3	4231	Conga T8
D3	4231	Conga T8
D#3	4231	Conga T8
E3	4231	Conga T8
F3	3027	Timbale1 Hi 1
F#3	3031	Timbale1 Lo 1
G3	2490	Glass
G#3	2490	Glass
A3	3062	Cabasa1A 1-2
A#3	4272	MaracasT8-1
B3	2613	FxGun2
C4	2612	FxGun1
C#4	4250	Analog Shaker
D4	4250	Analog Shaker
D#4	4276	Claves T8-1
E4	2512	Hi Q1
F4	2513	Hi Q2
F#4	2630	Scratch L
G4	2630	Scratch L
G#4	2884	Triangle1 Mute
A4	2883	Triangle1 Open
A#4	4250	Analog Shaker
B4	2908	Sleigh Bell1
C5	2912	Wind Chime 1
C#5	5408	Sd Hip1
D5	5409	Sd Hip2
D#5	5411	Sd Hip Gate
E5	5417	Sd Break 1
F5	4595	Bd Brip
F#5	5422	Sd FX1
G5	4626	Bd FxHammer
G#5	5437	Sd Hammer
A5	4627	Bd ZapHard
A#5	5430	Sd Garg L
B5	4630	Bd TekPower
C6	4636	Bd Slimy

Solaris

Note	Wave Number	Wave Name
C0	5458	Sd TB Comp2
C#0	5457	Sd TB Comp1
D0	2532	Abstract Fx2
D#0	2534	Abstract Fx4
E0	2541	Damage Fx5
F0	2543	Damage Fx7
F#0	2546	Damage Fx10
G0	2541	Damage Fx5
G#0	2563	Electric Fx Perc8
A0	4685	Bd Body2
A#0	5451	Sd ShortDry2
B0	4682	Bd LongBass
C1	4679	Bd EDM09
C#1	2556	Electric Fx Perc1
D1	5451	Sd ShortDry2
D#1	4190	RX11 Clap
E1	5445	Sd Clap1
F1	6138	Comp EleTom Low
F#1	5817	HH ClosedNine
G1	6138	Comp EleTom Low
G#1	5818	HH PedalNine
A1	6138	Comp EleTom Low
A#1	5819	HH OpenNine
B1	6137	Comp EleTom High
C2	2572	White Noise
C#2	6199	PI Crash 15
D2	2572	White Noise
D#2	6262	Fine Ride Bow
E2	6292	China4
F2	6264	Fine Ride Cup
F#2	3088	Pandeiro1 Tip
G2	6200	PI Crash 16
G#2	2513	Hi Q2
A2	6200	PI Crash 16
A#2	2513	Hi Q2
B2	6263	Fine Ride Edge
C3	2801	Electric Bass FX 09
C#3	2281	Mini Brip6
D3	2276	Mini Brip1
D#3	2277	Mini Brip2
E3	2967	Quinto1 Slap
F3	3288	Tabla1 Bya
F#3	3272	Djembe1 Edge
G3	3289	Tabla1 Nah
G#3	3545	Barasim Tak
A3	4188	Electric Clap1
A#3	2509	Electric Perc13
B3	2392	Hop FX1
C4	4558	Bd DanceGate1
C#4	2552	Noize Rize1
D4	2553	Noize Rize2
D#4	2533	Abstract Fx3
E4	2535	Abstract Fx5
F4	4286	Analog Click
F#4	5780	HH Closed T8-1
G4	5431	Sd FM
G#4	5570	HH Half Open2 RL
A4	4276	Claves T8-1
A#4	5781	HH Open T8-1
B4	6346	Reverse Cymbal1
C5	4653	Bd HrdSpecial
C#5	4681	Bd EDM Gate
D5	4559	Bd DanceGate2
D#5	2547	Damage Fx11
E5	4662	Bd Stack3
F5	4680	Bd EDM10
F#5	5178	Sd BreakRim
G5	2570	Electric Fx Perc15
G#5	2550	Noize Fx1
A5	2544	Damage Fx8
A#5	2561	Electric Fx Perc6
B5	2559	Electric Fx Perc4
C6	2567	Electric Fx Perc12

Crumbler

Note	Wave Number	Wave Name
C0	5457	Sd TB Comp1
C#0	5456	Sd TB Q
D0	2531	Abstract Fx1
D#0	2534	Abstract Fx4
E0	2537	Damage Fx1
F0	2536	Bazer Fx
F#0	2539	Damage Fx3
G0	2532	Abstract Fx2
G#0	2563	Electric Fx Perc8
A0	4685	Bd Body2
A#0	5451	Sd ShortDry2
B0	4682	Bd LongBass
C1	4680	Bd EDM10
C#1	5452	Sd ShortGate1
D1	5456	Sd TB Q
D#1	4190	RX11 Clap
E1	5445	Sd Clap1
F1	6138	Comp EleTom Low
F#1	5820	HH TecClosed1
G1	6138	Comp EleTom Low
G#1	5822	HH TecClosed2
A1	6138	Comp EleTom Low
A#1	5823	HH TecOpen2
B1	6137	Comp EleTom High
C2	6137	Comp EleTom High
C#2	6199	PI Crash 15
D2	6137	Comp EleTom High
D#2	6262	Fine Ride Bow
E2	6292	China4
F2	6264	Fine Ride Cup
F#2	3088	Pandeiro1 Tip
G2	6200	PI Crash 16
G#2	2513	Hi Q2
A2	6200	PI Crash 16
A#2	2513	Hi Q2
B2	6263	Fine Ride Edge
C3	2790	Acoustic Bass FX07
C#3	2281	Mini Brip6
D3	2276	Mini Brip1
D#3	2277	Mini Brip2
E3	2967	Quinto1 Slap
F3	3288	Tabla1 Bya
F#3	3272	Djembe1 Edge
G3	3289	Tabla1 Nah
G#3	3545	Barasim Tak
A3	4188	Electric Clap1
A#3	2509	Electric Perc13
B3	2392	Hop FX1
C4	2550	Noize Fx1
C#4	2552	Noize Rize1
D4	2553	Noize Rize2
D#4	2533	Abstract Fx3
E4	2535	Abstract Fx5
F4	4286	Analog Click
F#4	5780	HH Closed T8-1
G4	5431	Sd FM
G#4	5570	HH Half Open2 RL
A4	4276	Claves T8-1
A#4	5781	HH Open T8-1
B4	6346	Reverse Cymbal1
C5	4558	Bd DanceGate1
C#5	4681	Bd EDM Gate
D5	4559	Bd DanceGate2
D#5	2547	Damage Fx11
E5	4662	Bd Stack3
F5	4680	Bd EDM10
F#5	5178	Sd BreakRim
G5	2570	Electric Fx Perc15
G#5	2551	Noize Fx2
A5	2544	Damage Fx8
A#5	2561	Electric Fx Perc6
B5	2559	Electric Fx Perc4
C6	2564	Electric Fx Perc9

Moving Floor

Note	Wave Number	Wave Name
C0	5457	Sd TB Comp1
C#0	5456	Sd TB Q
D0	2531	Abstract Fx1
D#0	2534	Abstract Fx4
E0	2537	Damage Fx1
F0	2536	Bazer Fx
F#0	2539	Damage Fx3
G0	2532	Abstract Fx2
G#0	2563	Electric Fx Perc8
A0	4676	Bd EDM06
A#0	5450	Sd ShortDry1
B0	4662	Bd Stack3
C1	4701	House BD 2 St
C#1	5452	Sd ShortGate1
D1	5459	Dub SD 1 St
D#1	4190	RX11 Clap
E1	5456	Sd TB Q
F1	6138	Comp EleTom Low
F#1	5817	HH ClosedNine
G1	6138	Comp EleTom Low
G#1	5818	HH PedalNine
A1	6138	Comp EleTom Low
A#1	5819	HH OpenNine
B1	6137	Comp EleTom High
C2	6137	Comp EleTom High
C#2	6199	PI Crash 15
D2	6137	Comp EleTom High
D#2	6262	Fine Ride Bow
E2	6292	China4
F2	6264	Fine Ride Cup
F#2	3088	Pandeiro1 Tip
G2	6200	PI Crash 16
G#2	2513	Hi Q2
A2	6200	PI Crash 16
A#2	2513	Hi Q2
B2	6263	Fine Ride Edge
C3	2790	Acoustic Bass FX07
C#3	2281	Mini Brip6
D3	2276	Mini Brip1
D#3	2277	Mini Brip2
E3	2967	Quinto1 Slap
F3	3288	Tabla1 Bya
F#3	3272	Djembe1 Edge
G3	3289	Tabla1 Nah
G#3	3545	Barasim Tak
A3	4188	Electric Clap1
A#3	2509	Electric Perc13
B3	2392	Hop FX1
C4	2550	Noize Fx1
C#4	2552	Noize Rize1
D4	2553	Noize Rize2
D#4	2533	Abstract Fx3
E4	2535	Abstract Fx5
F4	4286	Analog Click
F#4	5780	HH Closed T8-1
G4	5431	Sd FM
G#4	5570	HH Half Open2 RL
A4	4276	Claves T8-1
A#4	5781	HH Open T8-1
B4	6346	Reverse Cymbal1
C5	4558	Bd DanceGate1
C#5	4681	Bd EDM Gate
D5	4559	Bd DanceGate2
D#5	2547	Damage Fx11
E5	4662	Bd Stack3
F5	4680	Bd EDM10
F#5	5178	Sd BreakRim
G5	5347	Sd HandClap
G#5	2551	Noize Fx2
A5	2544	Damage Fx8
A#5	2561	Electric Fx Perc6
B5	2559	Electric Fx Perc4
C6	2564	Electric Fx Perc9

Trance Master

Note	Wave Number	Wave Name
C0	4561	Bd T9-2
C#0	5392	Sd AnSm Rim
D0	5324	Sd Elec9
D#0	4187	Clap AnSm
E0	5322	Sd Elec7
F0	5326	Sd Elec11
F#0	5322	Sd Elec7
G0	5376	Sd T8-1
G#0	5353	Sd T9-5
A0	4565	Bd T9 Hd2
A#0	5327	Sd Elec12
B0	4566	Bd T9 Hd3
C1	4631	Bd Hard Long
C#1	5355	Sd T9Rim
D1	5320	Sd Elec5
D#1	4179	Clap T9-1
E1	5350	Sd T9-2
F1	5433	Sd Syn
F#1	5766	HH Closed T9
G1	5433	Sd Syn
G#1	5767	HH Open T9
A1	5433	Sd Syn
A#1	5767	HH Open T9
B1	5433	Sd Syn
C2	5433	Sd Syn
C#2	6303	Crash T9-1
D2	5433	Sd Syn
D#2	6329	Ride T9-1
E2	6310	Crash Syn
F2	6281	Ride Cup Mono
F#2	2845	Tambourine1 Hit
G2	6305	Crash T8-1
G#2	4242	Cowbell T8
A2	6283	China1 St
A#2	4242	Cowbell T8
B2	6225	Ride1 St
C3	2979	Bongo1 Hi 1Fingr 1-2
C#3	2992	Bongo1 Lo 3Fingr 1-2
D3	2929	Conga1 Hi Slap
D#3	2928	Conga1 Hi Slap Open
E3	2926	Conga1 Hi Open 2
F3	6131	Tom Syn1
F#3	6131	Tom Syn1
G3	4286	Analog Click
G#3	2494	Noise Burst
A3	3064	Cabasa1A 2
A#3	3059	Maracas1 Slur
B3	2397	Neo Seq Em-3
C4	2413	Neo Seq2 Em-5
C#4	2497	Electric Perc1
D4	2825	Shaker Hip1
D#4	4276	Claves T8-1
E4	4258	Tambourine RX5
F4	4247	Cowbell RX11
F#4	2826	Shaker Hip2
G4	2506	Electric Perc10
G#4	2884	Triangle1 Mute
A4	2883	Triangle1 Open
A#4	2828	Shaker Hip4
B4	2496	Zap2
C5	4715	Bd HipHop8
C#5	4564	Bd T9 Hd1
D5	4643	Bd ElecComp3
D#5	4560	Bd T9-1
E5	4566	Bd T9 Hd3
F5	4631	Bd Hard Long
F#5	5780	HH Closed T8-1
G5	4642	Bd ElecComp2
G#5	5783	HH Open T8-2
A5	4564	Bd T9 Hd1
A#5	5781	HH Open T8-1
B5	4565	Bd T9 Hd2
C6	4643	Bd ElecComp3

Real Drums Kit

Note	Wave Number	Wave Name
C0	3217	Claves1
C#0	5224	Sd Brush Soft St
D0	5236	Sd Brush Swir St
D#0	5227	Sd Brush Med St
E0	5239	Sd Brush SwirAtt St
F0	5223	Bright Snare Roll
F#0	2860	Castanet1
G0	5219	LW Snare Sw
G#0	2855	Stick1
A0	4551	AT Kick Sw
A#0	5220	DG Snare1 Sw
B0	4552	GT Kick1 Sw
C1	4553	GT Kick2 Sw
C#1	5204	Sd Closed Rim5
D1	5221	DG Snare2 Sw
D#1	2895	Hand Clap3 Sw
E1	5222	TM Snare Sw
F1	6069	CP Tom Floor Sw
F#1	5757	PT HiHat Closed
G1	6069	CP Tom Floor Sw
G#1	5759	PT HiHat Pedal
A1	6068	CP Tom Low Sw
A#1	5758	PT HiHat Open
B1	6067	CP Tom Mid Sw
C2	6066	CP Tom High Sw
C#2	6201	ZJ Crash1 Sw
D2	6066	CP Tom High Sw
D#2	6258	ZJ Ride1 Tip Sw
E2	6202	ZJ Crash2 Sw
F2	6259	ZJ Ride1 Cup Sw
F#2	2843	Tambourine1 Sw
G2	6301	ZJ Splash1
G#2	3229	Cowbell5
A2	6203	ZJ Crash3 Sw
A#2	2879	Vibraslap1
B2	6260	ZJ Ride2 Tip Sw
C3	2979	Bongo1 Hi 1Fingr 1-2
C#3	2989	Bongo1 Lo 1Fingr 1-2
D3	2930	Conga1 Hi SlpMute1-2
D#3	2924	Conga1 Hi Open 1-2
E3	2935	Conga1 Lo Open 1-2
F3	3026	Timbale1 Hi 1-3
F#3	3030	Timbale1 Lo 1-2
G3	3105	Agogo1 Hi
G#3	3106	Agogo1 Lo
A3	3062	Cabasa1A 1-2
A#3	3059	Maracas1 Slur
B3	3220	Whistle
C4	3220	Whistle
C#4	3113	Guiro1 Short
D4	3112	Guiro1 Long
D#4	3217	Claves1
E4	2872	Wood Block
F4	2872	Wood Block
F#4	2975	Cuica1 Hi
G4	2974	Cuica1 Lo
G#4	2884	Triangle1 Mute
A4	2883	Triangle1 Open
A#4	2816	ShakerA 13
B4	2908	Sleigh Bell1
C5	2912	Wind Chime 1
C#5	4726	Sd Bld St1-4
D5	4885	Sd Blues 3St
D#5	4929	Sd Hip St1-2
E5	4826	Sd Funk St1-3
F5	4746	Sd Soul St1-4
F#5	5177	Sd LdwHMono
G5	5180	Sd Heavy
G#5	4909	Sd Tight St1-4
A5	4894	Sd BluesHeart St1-3
A#5	4367	Bd Snap 1-2
B5	4376	Bd Tight 1-2
C6	4403	Bd Funk St1-2

New Oak Custom Kit

Note	Wave Number	Wave Name
C0	5535	HH Pedal 1-3St
C#0	5224	Sd Brush Soft St
D0	5236	Sd Brush Swir St
D#0	5227	Sd Brush Med St
E0	5239	Sd Brush SwirAtt St
F0	5142	Sd Metal SnRoll St
F#0	2860	Castanet1
G0	5061	Sd Oak 2 St
G#0	2856	Stick2
A0	4490	Bd Oak Open 1-2 St
A#0	5130	Sd Metal OpRm 1-2 St
B0	4499	Bd Oak Close 1-2 St
C1	4490	Bd Oak Open 1-2 St
C#1	5079	Sd Oak ClRm St
D1	5052	Sd Oak 1-4 St
D#1	5142	Sd Metal SnRoll St
E1	5070	Sd Oak OpRm 1-2 St
F1	6011	Tom Oak Floor 1-2 St
F#1	5515	HH Closed 1-4St
G1	6011	Tom Oak Floor 1-2 St
G#1	5567	HH Half Open2 St
A1	5999	Tom Oak Mid 1-2 St
A#1	5553	HH Open 2St
B1	5999	Tom Oak Mid 1-2 St
C2	5987	Tom Oak Hi 1-2 St
C#2	6181	Crash Brite St
D2	5987	Tom Oak Hi 1-2 St
D#2	6233	Ride Brite St
E2	6288	China3 St
F2	6237	Ride Brite Cup St
F#2	2846	Tambourine2 Sw
G2	6297	Splash2 St
G#2	3225	Cowbell3 Sw
A2	6185	Crash Dark St
A#2	2880	Vibraslap2
B2	6241	Ride Warm St
C3	3000	Bongo2 Hi Open 2
C#3	3004	Bongo2 Lo Open 2
D3	2944	Conga2 Hi Slap 2
D#3	2947	Conga2 Hi Open 2
E3	2950	Conga2 Lo Open 1
F3	3038	Timbale2 Hi 2
F#3	3042	Timbale2 Lo 2
G3	3105	Agogo1 Hi
G#3	3106	Agogo1 Lo
A3	3065	Cabasa1B 1-4
A#3	3059	Maracas1 Slur
B3	3220	Whistle
C4	3220	Whistle
C#4	3118	MetalGuiro Short 1-2
D4	3121	MetalGuiro Long
D#4	3218	Claves2
E4	2914	Resin Block Small
F4	2915	Resin Block Large
F#4	2975	Cuica1 Hi
G4	2974	Cuica1 Lo
G#4	2884	Triangle1 Mute
A4	2883	Triangle1 Open
A#4	2820	ShakerB Sw
B4	2909	Sleigh Bell2
C5	2912	Wind Chime 1
C#5	2889	Hand Clap1 St
D5	3126	Surdo2 Open
D#5	2941	Conga2 Hi Tip
E5	2940	Conga2 Hi Heel
F5	2942	Conga2 Hi Slap 1-2
F#5	2948	Conga2 Hi Mute
G5	2945	Conga2 Hi Open 1-2
G#5	2952	Conga2 Lo Slide
A5	2949	Conga2 Lo Open 1-2
A#5	3278	Djembe2 Mute
B5	3276	Djembe2 Lo
C6	3277	Djembe2 Slap

NewMapleCustom Kit

Note	Wave Number	Wave Name
C0	5682	HH Dark Pedal 1-2 St
C#0	5224	Sd Brush Soft St
D0	5236	Sd Brush Swir St
D#0	5227	Sd Brush Med St
E0	5239	Sd Brush SwirAtt St
F0	5142	Sd Metal SnRoll St
F#0	2860	Castanet1
G0	5061	Sd Oak 2 St
G#0	2856	Stick2
A0	4479	Bd Maple Close 2 L
A#0	5136	Sd Metal OpRm 2 St
B0	4481	Bd Maple Open 1-2 St
C1	4481	Bd Maple Open 1-2 St
C#1	5139	Sd Metal ClRm St
D1	5112	Sd Metal 1-4 St
D#1	5142	Sd Metal SnRoll St
E1	5115	Sd Metal 1-OpRm St
F1	5978	Tom Maple Flr 1-2 RL
F#1	5662	HH Dark Closed 1-4St
G1	5983	Tom Maple Flr 2 St
G#1	5551	HH Open 1-2St
A1	5971	Tom Maple Mid 2 St
A#1	5694	HH Dark Open 1-2 St
B1	5963	Tom Maple Mid 1-2 St
C2	5959	Tom Maple Hi 2 St
C#2	6181	Crash Brite St
D2	5951	Tom Maple Hi 1-2 St
D#2	6233	Ride Brite St
E2	6288	China3 St
F2	6237	Ride Brite Cup St
F#2	2846	Tambourine2 Sw
G2	6297	Splash2 St
G#2	3225	Cowbell3 Sw
A2	6185	Crash Dark St
A#2	2880	Vibraslap2
B2	6241	Ride Warm St
C3	3000	Bongo2 Hi Open 2
C#3	3004	Bongo2 Lo Open 2
D3	2944	Conga2 Hi Slap 2
D#3	2947	Conga2 Hi Open 2
E3	2950	Conga2 Lo Open 1
F3	3038	Timbale2 Hi 2
F#3	3042	Timbale2 Lo 2
G3	3105	Agogo1 Hi
G#3	3106	Agogo1 Lo
A3	3065	Cabasa1B 1-4
A#3	3059	Maracas1 Slur
B3	3220	Whistle
C4	3220	Whistle
C#4	3118	MetalGuiro Short 1-2
D4	3121	MetalGuiro Long
D#4	3218	Claves2
E4	2914	Resin Block Small
F4	2915	Resin Block Large
F#4	2975	Cuica1 Hi
G4	2974	Cuica1 Lo
G#4	2884	Triangle1 Mute
A4	2883	Triangle1 Open
A#4	2820	ShakerB Sw
B4	2909	Sleigh Bell2
C5	2912	Wind Chime 1
C#5	2889	Hand Clap1 St
D5	3126	Surdo2 Open
D#5	2941	Conga2 Hi Tip
E5	2940	Conga2 Hi Heel
F5	2942	Conga2 Hi Slap 1-2
F#5	2948	Conga2 Hi Mute
G5	2945	Conga2 Hi Open 1-2
G#5	2952	Conga2 Lo Slide
A5	2949	Conga2 Lo Open 1-2
A#5	3278	Djembe2 Mute
B5	3276	Djembe2 Lo
C6	3277	Djembe2 Slap

BeechwoodSnare Kit

Note	Wave Number	Wave Name
C0	5654	HH Power ClPedal St
C#0	5224	Sd Brush Soft St
D0	5236	Sd Brush Swir St
D#0	5227	Sd Brush Med St
E0	5239	Sd Brush SwirAtt St
F0	5142	Sd Metal SnRoll St
F#0	2860	Castanet1
G0	5088	Sd Beech 1 St
G#0	2856	Stick2
A0	4457	Bd PowerA 1St
A#0	5106	Sd Beech OpRm 2 St
B0	4401	Bd Normal 2L
C1	4447	Bd Jazz2St
C#1	5079	Sd Oak ClRm St
D1	5082	Sd Beech 1-4 St
D#1	5142	Sd Metal SnRoll St
E1	5085	Sd Beech 1-OpRm St
F1	5939	Tom Power04 1-2St
F#1	5614	HH Power ClTip 1-4St
G1	5927	Tom Power03 1-2St
G#1	5634	HH Power ClEgde1-4St
A1	5915	Tom Power02 1-2St
A#1	5658	HH Power Open EdgeSt
B1	5903	Tom Power01 1-2St
C2	5913	Tom Power01 2R
C#2	6181	Crash Brite St
D2	5913	Tom Power01 2R
D#2	6233	Ride Brite St
E2	6288	China3 St
F2	6237	Ride Brite Cup St
F#2	2846	Tambourine2 Sw
G2	6297	Splash2 St
G#2	3225	Cowbell3 Sw
A2	6185	Crash Dark St
A#2	2880	Vibraslap2
B2	6241	Ride Warm St
C3	3000	Bongo2 Hi Open 2
C#3	3004	Bongo2 Lo Open 2
D3	2944	Conga2 Hi Slap 2
D#3	2947	Conga2 Hi Open 2
E3	2950	Conga2 Lo Open 1
F3	3038	Timbale2 Hi 2
F#3	3042	Timbale2 Lo 2
G3	3105	Agogo1 Hi
G#3	3106	Agogo1 Lo
A3	3065	Cabasa1B 1-4
A#3	3059	Maracas1 Slur
B3	3220	Whistle
C4	3220	Whistle
C#4	3118	MetalGuiro Short 1-2
D4	3121	MetalGuiro Long
D#4	3218	Claves2
E4	2914	Resin Block Small
F4	2915	Resin Block Large
F#4	2975	Cuica1 Hi
G4	2974	Cuica1 Lo
G#4	2884	Triangle1 Mute
A4	2883	Triangle1 Open
A#4	2820	ShakerB Sw
B4	2909	Sleigh Bell2
C5	2912	Wind Chime 1
C#5	2889	Hand Clap1 St
D5	3126	Surdo2 Open
D#5	2941	Conga2 Hi Tip
E5	2940	Conga2 Hi Heel
F5	2942	Conga2 Hi Slap 1-2
F#5	2948	Conga2 Hi Mute
G5	2945	Conga2 Hi Open 1-2
G#5	2952	Conga2 Lo Slide
A5	2949	Conga2 Lo Open 1-2
A#5	3278	Djembe2 Mute
B5	3276	Djembe2 Lo
C6	3277	Djembe2 Slap

Real Brushes Kit

Note	Wave Number	Wave Name
C0	5249	Sd LW Brush Swir2 Sw
C#0	5245	Sd LW Brush Combi Sw
D0	5250	Sd LW Brush Swir3
D#0	5244	Sd LW Brush Slap Sw
E0	5251	Sd LW Brush Swir4
F0	5252	Sd LW Brush Swir5
F#0	5253	Sd LW Brush Swir6
G0	5242	Sd LW Brush Tap1 Sw
G#0	2855	Stick1
A0	4554	PL Kick1 Sw
A#0	5246	Sd LW Brush Rim1 Sw
B0	4555	PL Kick2 Sw
C1	4453	Bd PL Jazz HiSna Sw
C#1	5205	Sd Closed Rim6
D1	5243	Sd LW Brush Tap2 Sw
D#1	2895	Hand Clap3 Sw
E1	5247	Sd LW Brush Rim2 Sw
F1	6090	Tom Jazz FLR Sw
F#1	5763	HH IB Brush CIs
G1	6089	Tom Jazz LL Sw
G#1	5765	HH IB Brush PdL
A1	6089	Tom Jazz LL Sw
A#1	5764	HH IB Brush Opn
B1	6088	Tom Jazz LH Sw
C2	6087	Tom Jazz M Sw
C#2	6204	Jazz Crash1 Sw
D2	6086	Tom Jazz H Sw
D#2	6273	Ride Brush3 Tip Sw
E2	6218	ZJ Crash Brush Sw
F2	6274	Ride Brush3 Cup Sw
F#2	2843	Tambourine1 Sw
G2	6302	ZJ Splash2 Sw
G#2	3229	Cowbell5
A2	6205	Jazz Crash2 Sw
A#2	2879	Vibraslap1
B2	6275	Ride Brush4 Cup Sw
C3	2979	Bongo1 Hi 1Fingr 1-2
C#3	2989	Bongo1 Lo 1Fingr 1-2
D3	2930	Conga1 Hi SlpMute1-2
D#3	2924	Conga1 Hi Open 1-2
E3	2935	Conga1 Lo Open 1-2
F3	3026	Timbale1 Hi 1-3
F#3	3030	Timbale1 Lo 1-2
G3	3105	Agogo1 Hi
G#3	3106	Agogo1 Lo
A3	3062	Cabasa1A 1-2
A#3	3059	Maracas1 Slur
B3	3220	Whistle
C4	3220	Whistle
C#4	3113	Guiro1 Short
D4	3112	Guiro1 Long
D#4	3217	Claves1
E4	2872	Wood Block
F4	2872	Wood Block
F#4	2975	Cuica1 Hi
G4	2974	Cuica1 Lo
G#4	2884	Triangle1 Mute
A4	2883	Triangle1 Open
A#4	2816	ShakerA 13
B4	2908	Sleigh Bell1
C5	2912	Wind Chime 1
C#5	4726	Sd Bld St1-4
D5	4885	Sd Blues 3St
D#5	4929	Sd Hip St1-2
E5	4826	Sd Funk St1-3
F5	4746	Sd Soul St1-4
F#5	5177	Sd LdwHMono
G5	5180	Sd Heavy
G#5	4909	Sd Tight St1-4
A5	4894	Sd BluesHeart St1-3
A#5	4367	Bd Snap 1-2
B5	4376	Bd Tight 1-2
C6	4403	Bd Funk St1-2

Jazz Brushes Kit

Note	Wave Number	Wave Name
C0	5683	HH Dark Pedal 1-2 L
C#0	5224	Sd Brush Soft St
D0	5236	Sd Brush Swir St
D#0	5227	Sd Brush Med St
E0	5239	Sd Brush SwirAtt St
F0	5215	Sd Roll Mono
F#0	2860	Castanet1
G0	5151	Sd NJz 1 St
G#0	2856	Stick2
A0	4444	Bd Jazz1St
A#0	5130	Sd Metal OpRm 1-2 St
B0	4450	Bd FK Jazz St
C1	4450	Bd FK Jazz St
C#1	5172	Sd NJz ClRm St
D1	5230	Sd Brush vari St
D#1	5224	Sd Brush Soft St
E1	5227	Sd Brush Med St
F1	6082	Tom Brush Floor St
F#1	5760	HH Brush Closed
G1	6078	Tom Brush Low St
G#1	5762	HH Brush Pedal
A1	6074	Tom Brush Mid St
A#1	5738	HH NJz Open 1-2 St
B1	6074	Tom Brush Mid St
C2	6070	Tom Brush Hi St
C#2	6214	Crash Brush2 St
D2	6070	Tom Brush Hi St
D#2	6269	Ride Brush2 St
E2	6206	Crash Brush1 St
F2	6210	Crash Brush Cup St
F#2	2846	Tambourine2 Sw
G2	6297	Splash2 St
G#2	3225	Cowbell3 Sw
A2	6214	Crash Brush2 St
A#2	2880	Vibraslap2
B2	6267	Ride Brush1 R
C3	3000	Bongo2 Hi Open 2
C#3	3004	Bongo2 Lo Open 2
D3	2944	Conga2 Hi Slap 2
D#3	2947	Conga2 Hi Open 2
E3	2950	Conga2 Lo Open 1
F3	3038	Timbale2 Hi 2
F#3	3042	Timbale2 Lo 2
G3	3105	Agogo1 Hi
G#3	3106	Agogo1 Lo
A3	3065	Cabasa1B 1-4
A#3	3059	Maracas1 Slur
B3	3220	Whistle
C4	3220	Whistle
C#4	3118	MetalGuiro Short 1-2
D4	3121	MetalGuiro Long
D#4	3218	Claves2
E4	2914	Resin Block Small
F4	2915	Resin Block Large
F#4	2975	Cuica1 Hi
G4	2974	Cuica1 Lo
G#4	2884	Triangle1 Mute
A4	2883	Triangle1 Open
A#4	2820	ShakerB Sw
B4	2909	Sleigh Bell2
C5	2912	Wind Chime 1
C#5	2905	Finger Snap3
D5	3126	Surdo2 Open
D#5	2941	Conga2 Hi Tip
E5	2940	Conga2 Hi Heel
F5	2942	Conga2 Hi Slap 1-2
F#5	2948	Conga2 Hi Mute
G5	2945	Conga2 Hi Open 1-2
G#5	2952	Conga2 Lo Slide
A5	2949	Conga2 Lo Open 1-2
A#5	3278	Djembe2 Mute
B5	3276	Djembe2 Lo
C6	3277	Djembe2 Slap

Jazz Sticks Kit

Note	Wave Number	Wave Name
C0	5682	HH Dark Pedal 1-2 St
C#0	5224	Sd Brush Soft St
D0	5236	Sd Brush Swir St
D#0	5227	Sd Brush Med St
E0	5239	Sd Brush SwirAtt St
F0	5215	Sd Roll Mono
F#0	2860	Castanet1
G0	5151	Sd NJz 1 St
G#0	2856	Stick2
A0	4514	Bd NJz Closed 2 St
A#0	5106	Sd Beech OpRm 2 St
B0	4517	Bd NJz Open 1-2 St
C1	4508	Bd NJz Closed 1-2 St
C#1	5172	Sd NJz ClRm St
D1	5145	Sd NJz 1-4 St
D#1	5209	Sd RockRollID St
E1	5148	Sd NJz 1-OpRm St
F1	6047	Tom NJz Floor 1-2 St
F#1	5662	HH Dark Closed 1-4St
G1	6035	Tom NJz Low 1-2 St
G#1	5682	HH Dark Pedal 1-2 St
A1	6031	Tom NJz Mid 2 St
A#1	5694	HH Dark Open 1-2 St
B1	6027	Tom NJz Mid 1 St
C2	6027	Tom NJz Mid 1 St
C#2	6193	Crash NJzB St
D2	6023	Tom NJz Mid 1-2 St
D#2	6245	Ride NJz St
E2	6288	China3 St
F2	6249	Ride NJz Cup St
F#2	2846	Tambourine2 Sw
G2	6297	Splash2 St
G#2	3225	Cowbell3 Sw
A2	6189	Crash NJzA St
A#2	2880	Vibraslap2
B2	6229	Ride2 St
C3	3000	Bongo2 Hi Open 2
C#3	3004	Bongo2 Lo Open 2
D3	2944	Conga2 Hi Slap 2
D#3	2947	Conga2 Hi Open 2
E3	2950	Conga2 Lo Open 1
F3	3038	Timbale2 Hi 2
F#3	3042	Timbale2 Lo 2
G3	3105	Agogo1 Hi
G#3	3106	Agogo1 Lo
A3	3065	Cabasa1B 1-4
A#3	3059	Maracas1 Slur
B3	3220	Whistle
C4	3220	Whistle
C#4	3118	MetalGuiro Short 1-2
D4	3121	MetalGuiro Long
D#4	3218	Claves2
E4	2914	Resin Block Small
F4	2915	Resin Block Large
F#4	2975	Cuica1 Hi
G4	2974	Cuica1 Lo
G#4	2884	Triangle1 Mute
A4	2883	Triangle1 Open
A#4	2820	ShakerB Sw
B4	2909	Sleigh Bell2
C5	2912	Wind Chime 1
C#5	2905	Finger Snap3
D5	3126	Surdo2 Open
D#5	2941	Conga2 Hi Tip
E5	2940	Conga2 Hi Heel
F5	2942	Conga2 Hi Slap 1-2
F#5	2948	Conga2 Hi Mute
G5	2945	Conga2 Hi Open 1-2
G#5	2952	Conga2 Lo Slide
A5	2949	Conga2 Lo Open 1-2
A#5	3278	Djembe2 Mute
B5	3276	Djembe2 Lo
C6	3277	Djembe2 Slap

D'elo Kit

Note	Wave Number	Wave Name
C0	2905	Finger Snap3
C#0	5224	Sd Brush Soft St
D0	5236	Sd Brush Swir St
D#0	5227	Sd Brush Med St
E0	5239	Sd Brush SwirAtt St
F0	3437	Zangooreh Roll
F#0	2904	Finger Snap2
G0	5313	Caixa1 RimShot
G#0	2855	Stick1
A0	4622	Light BD
A#0	4747	Sd Soul St1-3
B0	4517	Bd NJz Open 1-2 St
C1	4508	Bd NJz Closed 1-2 St
C#1	5506	Sd HipHop Rim2
D1	5509	Sd HipHop Rim5
D#1	2897	Arabic Hand Clap
E1	5109	Sd Beech ClRm St
F1	6069	CP Tom Floor Sw
F#1	5614	HH Power ClTip 1-4St
G1	6069	CP Tom Floor Sw
G#1	5726	HH NJz Pedal 1-2 St
A1	6068	CP Tom Low Sw
A#1	5758	PT HiHat Open
B1	6067	CP Tom Mid Sw
C2	6066	CP Tom High Sw
C#2	6201	ZJ Crash1 Sw
D2	6066	CP Tom High Sw
D#2	6258	ZJ Ride1 Tip Sw
E2	6202	ZJ Crash2 Sw
F2	6259	ZJ Ride1 Cup Sw
F#2	2843	Tambourine1 Sw
G2	6301	ZJ Splash1
G#2	3229	Cowbell5
A2	6203	ZJ Crash3 Sw
A#2	2879	Vibraslap1
B2	6260	ZJ Ride2 Tip Sw
C3	2979	Bongo1 Hi 1Fingr 1-2
C#3	2989	Bongo1 Lo 1Fingr 1-2
D3	2930	Conga1 Hi SlpMute1-2
D#3	2924	Conga1 Hi Open 1-2
E3	2935	Conga1 Lo Open 1-2
F3	3047	Timbale3 Hi Rim
F#3	3046	Timbale3 Lo Rim
G3	3108	Agogo2 Bell1
G#3	3109	Agogo2 Bell2
A3	3065	Cabasa1B 1-4
A#3	3059	Maracas1 Slur
B3	3997	Darbuka3 RilTakToDom
C4	3977	Darbuka3 Tak BothHnd
C#4	3118	MetalGuiro Short 1-2
D4	3121	MetalGuiro Long
D#4	3219	Claves3
E4	2872	Wood Block
F4	2872	Wood Block
F#4	2975	Cuica1 Hi
G4	2974	Cuica1 Lo
G#4	2884	Triangle1 Mute
A4	2883	Triangle1 Open
A#4	3439	Shekere Shake Sw
B4	3764	Riq1 ShakeB 1-2
C5	2912	Wind Chime 1
C#5	4726	Sd Bld St1-4
D5	4885	Sd Blues 3St
D#5	4909	Sd Tight St1-4
E5	4826	Sd Funk St1-3
F5	4746	Sd Soul St1-4
F#5	5193	Sd Hip Stick6 St
G5	5191	Sd Hip Stick4
G#5	4216	HipHop Clap6
A5	4217	HipHop Clap7
A#5	4529	Bd GranCasaA Mute St
B5	4526	Bd GranCasaA Open St
C6	4389	Bd Ambience R1-2

T's EDM Kit

Note	Wave Number	Wave Name
C0	4620	Fresh BD St
C#0	4622	Light BD
D0	4621	Smith BD St
D#0	5335	Fresh Snare 2
E0	5329	Digital Snare St
F0	5328	Crisp Snare St
F#0	5333	Biting Snare 2
G0	5331	Echo Snare St
G#0	5336	Shrill Snare St
A0	4617	Artifact BD St
A#0	5337	Strong Snare Wire
B0	4618	Kindle BD St
C1	4619	Biting BD
C#1	5330	Elec Small Snare St
D1	5332	Biting Snare 1
D#1	4191	Clap Long Ambi St
E1	5334	Fresh Snare 1
F1	6160	Digital Tom Low St
F#1	5867	Tight HH Closed
G1	6160	Digital Tom Low St
G#1	5868	Fresh HH Closed
A1	6159	Digital Tom High St
A#1	5874	Crackle HH Open
B1	6166	Elec SE Tom St
C2	6166	Elec SE Tom St
C#2	6323	Novelty Crash
D2	6166	Elec SE Tom St
D#2	6339	Live Ride St
E2	6328	Phase Crash St
F2	6340	Fresh Ride St
F#2	2601	Glitch 4
G2	6322	EDM Crash St
G#2	2606	Glitch 9
A2	6324	Flange Crash St
A#2	2602	Glitch 5
B2	6341	Fine Ride St
C3	2956	Conga Fine 1 St
C#3	2957	Conga Fine 2 St
D3	2958	Conga FX
D#3	3262	Ethnic Perc 1
E3	3263	Ethnic Perc 2
F3	3264	Ethnic Perc 3
F#3	4271	WB Fresh Elec St
G3	4193	Clap Elec 1
G#3	4194	Clap Elec 2
A3	2830	Shaker Fresh 1
A#3	2831	Shaker Fresh 2
B3	2832	Shaker Fresh 3
C4	2598	Glitch 1
C#4	2599	Glitch 2
D4	2603	Glitch 6
D#4	2607	Glitch 10
E4	2604	Glitch 7
F4	2603	Glitch 6
F#4	2603	Glitch 6
G4	2603	Glitch 6
G#4	2603	Glitch 6
A4	2603	Glitch 6
A#4	2603	Glitch 6
B4	2603	Glitch 6
C5	2603	Glitch 6

T's Hip Hop Kit

Note	Wave Number	Wave Name
C0	2609	T8 Bass SE St
C#0	5338	Elec Jazz Snare St
D0	5346	Crackle Snare St
D#0	2608	T8 Bend
E0	5345	Elec Light Snare St
F0	5343	Snare Roll OneShot
F#0	5341	Clang Snare St
G0	5342	Ambi Snare
G#0	5339	Elec Tight Snare St
A0	4624	Electric BD St
A#0	5344	Fine Snare St
B0	4625	Clink BD St
C1	4623	Crackle BD St
C#1	5340	Electric Snare
D1	5348	Sd Long Snare Wire
D#1	4192	Clap Short Ambi St
E1	5347	Sd HandClap
F1	6164	Powerful Tom Mid St
F#1	5869	Elec HH 1 Closed
G1	6165	Powerful Tom Low St
G#1	5871	Elec HH 2 Closed
A1	6163	Powerful Tom High St
A#1	5870	Elec HH 1 Open
B1	6167	Fine Light Tom St
C2	6162	Light Tom Low St
C#2	6327	FX Crash St
D2	6161	Light Tom High St
D#2	6342	Clang Ride St
E2	6325	Crackle Crash St
F2	6343	Smith Ride St
F#2	2850	Tambourine FX 1
G2	6326	Electric Crash St
G#2	2851	Tambourine FX 2
A2	6328	Phase Crash St
A#2	4226	Snap & Clap St
B2	6345	Ride Hip Hop St
C3	3007	Bongo Extent 1 St
C#3	3009	Bongo Extent 3 St
D3	3008	Bongo Extent 2 St
D#3	3007	Bongo Extent 1 St
E3	3261	Stomp St
F3	2593	Vocal Snare St
F#3	2594	Vocal Ambi SE St
G3	2595	Vocal Shout Yeah St
G#3	2596	Vocal Shout Go St
A3	2833	Shaker Muffled 1 St
A#3	2834	Shaker Muffled 2 St
B3	2605	Glitch 8
C4	2605	Glitch 8
C#4	5872	Powerful HH Closed
D4	5873	Powerful HH Open
D#4	3267	Ethnic Perc 6
E4	3268	Ethnic Perc 7
F4	3269	Ethnic Perc 8
F#4	2597	Rainmaker St
G4	3266	Ethnic Perc 5
G#4	3265	Ethnic Perc 4
A4	4225	Snap Digital St
A#4	4227	Snap Long Ambi St
B4	4228	Snap Smith Snap St
C5	2913	Wind Chime 2 St

Arabic Mixed Kit 2

Note	Wave Number	Wave Name
C#0	4241	Analog Conga
D0	4241	Analog Conga
D#0	4241	Analog Conga
E0	2881	Vibraslap3
F0	4650	Bd Techno L
F#0	5440	Side Stick Analog
G0	5441	Snare Techno
G#0	3115	Guiro2 Long
A0	4651	Bd Techno Q
A#0	5218	Std Open Rimshot
B0	5443	NeoSnare2
C1	4652	Bd NeoKick
C#1	5442	NeoSnare1
D1	5444	NeoSnare3
D#1	2896	Hand Clap4
E1	5216	Std Snare
F1	6064	Std Tom Floor M
F#1	5753	Neo HiHat Closed
G1	6062	Std Tom Low L
G#1	5754	Neo HiHat HalfOpen
A1	6061	Std Tom Low H
A#1	5755	Neo HiHat Open
B1	6060	Std Tom Mid
C2	6060	Std Tom Mid
C#2	6197	Std Crash1
D2	6059	Std Tom High
D#2	5756	Dance HiHat Open
E2	6347	Reverse Cymbal2
F2	3048	Timbale4 Lo
F#2	2953	Conga3 Hi Open
G2	3048	Timbale4 Lo
G#2	2954	Conga3 Hi Mute
A2	2849	Tambourine3
A#2	2955	Conga3 Lo Open
B2	3228	Cowbell4
C3	3219	Claves3
C#3	3005	Bongo3 Hi Open
D3	2872	Wood Block
D#3	3006	Bongo3 Lo Open
E3	2872	Wood Block
F3	3357	Kurdish Dohol1 Lo
F#3	3072	Cabasa4
G3	3358	Kurdish Dohol1 Hi
G#3	2829	Std Shaker
A3	2904	Finger Snap2
A#3	3061	Maracas2
B3	2905	Finger Snap3
C4	3567	Twaisat3
C#4	3565	Twaisat1
D4	3566	Twaisat2
D#4	3567	Twaisat3
E4	3568	Twaisat4
F4	3316	Tablah Small Dom
F#4	3560	Tar Barashim Dom
G4	3317	Tablah Small Snap
G#4	3561	Tar Barashim Sak
A4	3318	Tablah Small Sak
A#4	3562	Tar Barashim Tak
B4	3319	Tablah Small Tik
C5	3327	Tablah Big Dom
C#5	3563	Segal Dom
D5	3395	Merwas Sak
D#5	3564	Segal Tak
E5	3329	Tablah Big Sak
F5	3320	Tablah Dom
F#5	3321	Tablah Tak1
G5	3330	Tablah Tremolo
G#5	3322	Tablah Tak2
A5	3323	Tablah Tik1
A#5	3326	Tablah Sak
B5	3325	Tablah Tik3
C6	3324	Tablah Tik2

Iranian Mix Kit

Note	Wave Number	Wave Name
C#0	3005	Bongo3 Hi Open
D0	3006	Bongo3 Lo Open
D#0	2953	Conga3 Hi Open
E0	2955	Conga3 Lo Open
F0	6065	Std Tom Floor L
F#0	5750	HH Std Closed
G0	6063	Std Tom Floor H
G#0	5752	HH Std Pedal
A0	6063	Std Tom Floor H
A#0	5751	HH Std Open
B0	6261	Std Ride
C1	4550	Bd Std Kick
C#1	5203	Sd Closed Rim4
D1	5216	Std Snare
D#1	6198	Std Crash2
E1	5217	Std Snare Tight
F1	3327	Tablah Big Dom
F#1	3329	Tablah Big Sak
G1	3328	Tablah Big Tak
G#1	4039	Daholla2 Sak
A1	4036	Daholla2 Dom
A#1	4038	Daholla2 Tak 2
B1	4037	Daholla2 Tak 1
C2	3791	Daf Tom bb
C#2	3799	Daf Chain Up2
D2	3796	Daf Back2
D#2	3800	Daf Chain Down2
E2	3794	Daf Chap
F2	3805	Daf Full Roll
F#2	3806	Daf Chain Roll
G2	3807	Daf Whipping Roll
G#2	2902	Iran Hand Clap
A2	2904	Finger Snap2
A#2	3463	Neghareh Roll
B2	3458	Neghareh Tom
C3	3461	Neghareh Snap
C#3	3459	Neghareh Chap
D3	3462	Neghareh Eshareh
D#3	3460	Neghareh Back
E3	3359	Kurdish Dohol2 Lo
F3	3360	Kurdish Dohol2 Hi
F#3	3361	Kurdish Dohol2LoBuzz
G3	3362	Lurish Dohol Lo
G#3	3363	Kurdish Dohol Lo Buzz
A3	3364	Lurish Dohol Hi
A#3	3874	Tombak Full Roll
B3	3875	Tombak Timapni Roll
C4	3869	Tombak Tom2
C#4	3873	Tombak Eshareh Right
D4	3870	Tombak Back
D#4	3872	Tombak Eshareh Left
E4	3871	Tombak Snap
F4	4016	Zarb2 Tom
F#4	4020	Zarb2 Whipping
G4	4019	Zarb2 Back
G#4	4017	Zarb2 Eshareh
A4	4018	Zarb2 Chap
A#4	4022	Zarb2 Full Roll
B4	4021	Zarb2 Snap
C5	4023	Zarb2 Whipping Roll
C#5	3818	Dayereh1 Roll
D5	3819	Dayereh2 Tom
D#5	3820	Dayereh2 Eshareh
E5	3821	Dayereh2 Back
F5	3822	Dayereh2 Snap
F#5	3825	Dayereh2 Edge Roll
G5	3568	Twaisat4
G#5	3566	Twaisat2
A5	3569	Twaisat5
A#5	3565	Twaisat1
B5	3048	Timbale4 Lo
C6	3048	Timbale4 Lo

Brazil Kit 1

Note	Wave Number	Wave Name
C0	3246	Repique2 St Centr
C#0	3249	Repique2 St RmSht
D0	3247	Repique2 St Hd Slap
D#0	3248	Repique2 St Rim
E0	3250	Repique3 St Centr
F0	3251	Repique3 St RmSht
F#0	3148	Zabmba Mute RH
G0	3147	Zabmba Open RH
G#0	3146	Zabmba STick LH
A0	3136	Surdo5-1 Mute
A#0	3135	Surdo5-1 Open
B0	3134	Surdo5-1 Stop
C1	3137	Surdo5-2 Sdstck
C#1	5313	Caixa1 RimShot
D1	5312	Caixa1 Center
D#1	3085	Tumbo5 Rim Close
E1	3084	Tumbo5 Center Open
F1	3083	Tumbo5 Finger Back
F#1	3082	Tumbo4 Down
G1	3081	Tumbo4 Up
G#1	3133	Surdo4 Mute
A1	3132	Surdo4 Open
A#1	3131	Surdo4 Stop
B1	3130	Surdo3 Mute
C2	3129	Surdo3 Open
C#2	3128	Surdo3 Stop
D2	3145	Tntan2 Close RH
D#2	3144	Tntan2 Open RH
E2	3143	Tntan2 Slap RH
F2	3142	Tntan2 Body LH
F#2	3094	Pandeiro2 LThmb Cls
G2	3093	Pandeiro2 LThmb Opn
G#2	3091	Pandeiro2 LToe Rim
A2	3090	Pandeiro2 LHeel
A#2	3092	Pandeiro2 LSlap
B2	3095	Pandeiro2 LRoll
C3	3122	Reco1
C#3	2911	Chocal Forward
D3	3076	Caxixi 3
D#3	3047	Timbale3 Hi Rim
E3	3046	Timbale3 Lo Rim
F3	3045	Timbale3 Hi
F#3	3044	Timbale3 Lo
G3	3108	Agogo2 Bell1
G#3	3109	Agogo2 Bell2
A3	3110	Agogo3 Click
A#3	3111	Agogo4 Click
B3	3070	Cabasa2
C4	3056	Ganza2 Forward1
C#4	3255	Repique4 Anel Rim LH
D4	3254	Repique4 Anel Rim RH
D#4	3253	Repique4 Anel Mute
E4	3252	Repique4 Anel Open
F4	2978	Cuica2 Hi
F#4	2977	Cuica2 Med
G4	2976	Cuica2 Low
G#4	2886	Triangle2 Mute
A4	2885	Triangle2 Open
A#4	3258	Repique5 Mao Slap
B4	3257	Repique5 Mao Rim
C5	3256	Repique5 Mao Open
C#5	3222	Apito Hi Short
D5	3221	Apito Lo Short

Brazil Kit 2

Note	Wave Number	Wave Name
C0	3246	Repique2 St Centr
C#0	3249	Repique2 St RmSht
D0	3247	Repique2 St Hd Slap
D#0	3248	Repique2 St Rim
E0	3250	Repique3 St Centr
F0	3251	Repique3 St RmSht
F#0	3148	Zabmba Mute RH
G0	3147	Zabmba Open RH
G#0	3146	Zabmba STick LH
A0	3136	Surdo5-1 Mute
A#0	3135	Surdo5-1 Open
B0	3134	Surdo5-1 Stop
C1	3137	Surdo5-2 Sdstck
C#1	5315	Caixa2 RimShot
D1	5314	Caixa2 Center
D#1	3085	Tumbo5 Rim Close
E1	3084	Tumbo5 Center Open
F1	3083	Tumbo5 Finger Back
F#1	3082	Tumbo4 Down
G1	3081	Tumbo4 Up
G#1	3133	Surdo4 Mute
A1	3132	Surdo4 Open
A#1	3131	Surdo4 Stop
B1	3130	Surdo3 Mute
C2	3129	Surdo3 Open
C#2	3128	Surdo3 Stop
D2	3141	Tntan1 Open RH
D#2	3140	Tntan1 Thmb Open RH
E2	3139	Tntan1 Slap RH
F2	3138	Tntan1 Body
F#2	3100	Pandeiro2 CThmb Cls
G2	3099	Pandeiro2 CThmb Opn
G#2	3097	Pandeiro2 CToe Opn
A2	3096	Pandeiro2 CHeel
A#2	3098	Pandeiro2 CSlap
B2	3101	Pandeiro2 CRoll Lng
C3	3123	Reco2
C#3	2911	Chocal Forward
D3	3076	Caxixi 3
D#3	3047	Timbale3 Hi Rim
E3	3046	Timbale3 Lo Rim
F3	3045	Timbale3 Hi
F#3	3044	Timbale3 Lo
G3	2824	ShakerC 2 Sw
G#3	2823	ShakerC 1 Sw
A3	3077	Afoxe Open
A#3	3071	Cabasa3
B3	3070	Cabasa2
C4	3057	Ganza2 Forward2
C#4	3255	Repique4 Anel Rim LH
D4	3254	Repique4 Anel Rim RH
D#4	3253	Repique4 Anel Mute
E4	3252	Repique4 Anel Open
F4	2978	Cuica2 Hi
F#4	2977	Cuica2 Med
G4	2976	Cuica2 Low
G#4	2888	Triangle3 Mute
A4	2887	Triangle3 Open
A#4	3258	Repique5 Mao Slap
B4	3257	Repique5 Mao Rim
C5	3256	Repique5 Mao Open
C#5	3222	Apito Hi Short
D5	3221	Apito Lo Short

Turkish St Kit

Note	Wave Number	Wave Name
C0	3217	Claves1
C#0	3573	AsmaDavul L Side 1-2
D0	3577	AsmaDavul R Side 1-2
D#0	3570	AsmaDavulSideBdy 1-2
E0	3576	AsmaDavul Both Sides
F0	3591	KoltukDavulOpenFlam
F#0	3583	KoltukDavulTekeOp1-3
G0	3587	KoltukDavulTekOp 1-3
G#0	3580	Koltuk Davul Dum 1-2
A0	3626	Bendir Teke OpenFlam
A#0	3633	Bendir1 Teke Dead1-2
B0	3630	Bendir1 Tek Dead1-2
C1	3622	Bendir Teke 1-3
C#1	3618	Bendir Tek 1-3
D1	3627	Bendir Slap 1-2
D#1	3615	Bendir Dum 1-2
E1	3713	Sagat1 R Close 1-2
F1	3712	Sagat1 R Open
F#1	3717	Sagat1 L Close 1-2
G1	3716	Sagat1 L Open
G#1	3743	Riq1 Teke Flam
A1	3737	Riq1 Tek Mute 1-2
A#1	3740	Riq1 Teke Damped 1-2
B1	3744	Riq1 TekMIMed 1-2
C2	3730	Riq1 Dum Mute
C#2	3754	Riq1 Cymbal 1-2
D2	3757	Riq1 Cymbal Mute 1-2
D#2	3767	Riq1 Tremolo
E2	3761	Riq1 ShakeA 1-2
F2	3764	Riq1 ShakeB 1-2
F#2	3753	Riq1 Tek Flam
G2	3760	Riq1 Full Open
G#2	3750	Riq1 TekeOpnShrt 1-2
A2	3747	Riq1 TekOpnShrt 1-2
A#2	3734	Riq1 Tek Open 1-2
B2	3731	Riq1 Dum Open 1-2
C3	3837	Hollo FingerDead 1-2
C#3	3834	Hollo Slap 1-2
D3	3831	Hollo Dum 1-2
D#3	4114	Kasik 1-2
E3	4118	Kasik Flam
F3	3858	Tombek Tek Dead Sw
F#3	3860	Tombek Tek Flam
G3	3864	Tombek Teke 1-3
G#3	3854	TombekTekeOthFng 1-3
A3	3850	TombekTekelndFng 1-3
A#3	3846	Tombek Tek 1-3
B3	3843	Tombek Slap 1-2
C4	3861	Tombek Slap Med 1-2
C#4	3840	Tombek Dum 1-2
D4	3950	Darbuka1 Roll Close
D#4	3948	Darbuka1 RollOpen
E4	3949	Darbuka1 TekeDmpFlam
F4	3951	Darbuka1 TekDead 1-3
F#4	3955	Darbuka1 TekDampd1-3
G4	3947	Darbuka1 TekeOpnFlam
G#4	3959	Darbuka1 TekeOpen1-3
A4	3933	Darb1TekeOthFngA 1-3
A#4	3925	Darb1TekeIndFngA 1-3
B4	3917	Darbuka1 Tekal 1-3
C5	3937	Darb1TekeOthFngB 1-3
C#5	3929	Darb1TekeIndFngB 1-3
D5	3921	Darbuka1 TekB 1-3
D#5	3944	Darbuka1 SlapMed 1-2
E5	3941	Darbuka1 Slap 1-2
F5	3914	Darbuka1 Dum 1-2
F#5	4127	Bonges Tek Roll
G5	4128	Bonges Flam
G#5	4126	Bonges Tek Flam
A5	4122	Bonges Tek 1-2
A#5	4125	Bonges Slap
B5	4129	Bonges Flam Hi
C6	4119	Bonges Dum 1-2

New Arabic Kit 1

Note	Wave Number	Wave Name
C#0	3720	Sagat2 Close
D0	3722	Sagat3 Close
D#0	3721	Sagat3 Open
E0	3724	Sagat4 Close
F0	3723	Sagat4 Open
F#0	3826	Mazhar Dom Open
G0	3827	Mazhar Dom Close
G#0	3829	Mazhar Tak Close
A0	3828	Mazhar Tak Open
A#0	3830	Mazhar Sak Close
B0	4052	Katem1 Dom1
C1	4054	Katem1 Tak Open1
C#1	4053	Katem1 Dom2
D1	4055	Katem1 Tak Open2
D#1	4056	Katem1 Sak1
E1	3337	Tabel Saaidi Dom
F1	3284	Djembe4 Tak1
F#1	3338	Tabel Saaidi Tak
G1	3285	Djembe4 Tak2
G#1	3340	Tabel Dom
A1	3341	Tabel Tak
A#1	3342	Tabel Tak Wood
B1	3770	Riq3 Dom Close
C2	3769	Riq3 Dom Open
C#2	3772	Riq3 Tak Close1
D2	3771	Riq3 Tak Open
D#2	3773	Riq3 Tak Close2
E2	3774	Riq3 Tak Snouj
F2	3768	Riq2 Sak
F#2	3775	Riq3 Snouj Close1
G2	3776	Riq3 Snouj Close2
G#2	3778	Riq3 Flam
A2	3777	Riq3 Sak
A#2	3779	Riq3 Snouj Roll
B2	3963	Darbuka2 Dom LH
C3	3964	Darbuka2 Dom RH
C#3	3966	Darbuka2 TakLndxFng
D3	3967	Darbuka2 TakRlndxFng
D#3	3965	Darbuka2 Sak1
E3	3968	Darbuka2 TakLRingFng
F3	3970	Darbuka2 Tap1
F#3	3971	Darbuka2 Tap2
G3	3972	Darbuka2 Flam1
G#3	3974	Darbuka2 Tak Roll
A3	4177	Arabic Zalgouta Opn
A#3	4178	Arabic Zalgouta Cls
B3	4024	Daholla1 Dom LH
C4	4025	Daholla1 Dom RH
C#4	4026	Daholla1 Tak1
D4	4027	Daholla1 Tak2
D#4	4028	Daholla1 Tak3
E4	4029	Daholla1 Tak4
F4	4030	Daholla1 Sak
F#4	4031	Daholla1 Rak1
G4	2897	Arabic Hand Clap
G#4	4033	Daholla1 Flam1
A4	4034	Daholla1 Flam2
A#4	4035	Daholla1 Tak Roll
B4	3292	Tabla2 Dom & Tak
C5	3293	Tabla2 Dom
C#5	3294	Tabla2 Tak1
D5	3295	Tabla2 Tak2
D#5	3296	Tabla2 Tak3
E5	3297	Tabla2 Tak4
F5	3298	Tabla2 Sak
F#5	3299	Tabla2 Rak1
G5	3300	Tabla2 Rak2
G#5	3301	Tabla2 Flam1
A5	3302	Tabla2 Flam2
A#5	3303	Tabla2 Tak Roll
B5	3282	Djembe4 Dom1
C6	3283	Djembe4 Dom2

New Arabic Kit 2

Note	Wave Number	Wave Name
C1	3636	Bendir2 Lrg Dom Opn1
C#1	3637	Bendir2 Lrg Dom Opn2
D1	3638	Bendir2 Lrg Dom Cls
D#1	3639	Bendir2 Lrg Sak1
E1	3640	Bendir2 Lrg Sak2
F1	3641	Bendir2 Lrg Tak Opn1
F#1	3642	Bendir2 Lrg Tak Opn2
G1	3646	Bendir2 Lrg Flam
G#1	3643	Bendir2 Lrg 1
A1	3644	Bendir2 Lrg 2
A#1	3645	Bendir2 Lrg 3
B1	3647	Bendir2 Lrg Flam&Tak
C2	3365	Nakrazan Dom
C#2	3366	Nakrazan Flam
D2	3367	Nakrazan Tak 1
D#2	3368	Nakrazan Tak 2
E2	3369	Nakrazan Tak 3
F2	3370	Nakrazan GlisDn pppp
F#2	3371	Nakrazan GlisDn ppp
G2	3372	Nakrazan GlisDn pp
G#2	3373	Nakrazan GlisDn p
A2	3374	Nakrazan Noise FX
A#2	3375	Nakrazan Roll1
B2	3376	Nakrazan Roll2
C3	4058	Katem2 Dom1
C#3	4059	Katem2 Dom2
D3	4060	Katem2 Tak Open1
D#3	4061	Katem2 Tak Open2
E3	4064	Katem2 Sak
F3	4065	Katem2 Sak Close1
F#3	4066	Katem2 Sak Close2
G3	4067	Katem2 Flam1
G#3	4068	Katem2 Flam2
A3	4062	Katem2 Tak Close1
A#3	4063	Katem2 Tak Close2
B3	4069	Katem2 Trem Dom
C4	4070	Katem2 Med Dom Opn1
C#4	4071	Katem2 Med Dom Opn2
D4	4072	Katem2 Med Dom Opn3
D#4	4073	Katem2 Med Dom Close
E4	4074	Katem2 Med Tak1
F4	4075	Katem2 Med Tak2
F#4	4076	Katem2 Med Sak1
G4	4077	Katem2 Med Sak2
G#4	4080	Katem2 Med Flam
A4	4078	Katem2 Med1
A#4	4079	Katem2 Med2
B4	4081	Katem2 Med Flam&Tak
C5	4082	Katem2 Sml Dom Opn
C#5	4083	Katem2 Sml Dom Cls1
D5	4084	Katem2 Sml Dom Cls2
D#5	4085	Katem2 Sml Tak1
E5	4086	Katem2 Sml Tak2
F5	4087	Katem2 Sml Sak
F#5	4091	Katem2 Sml Flam
G5	4088	Katem2 Sml1
G#5	4089	Katem2 Sml2
A5	4090	Katem2 Sml3
A#5	4092	Katem2 Sml Flam&Tak
B5	4093	Katem2 Sml Fing Tak

New Maghrebi Kit

Note	Wave Number	Wave Name
C0	3689	AlgrnBendir TakDroit
C#0	3690	AlgrnBendir TakGuche
D0	3691	AlgrnBendir Kaf
D#0	4130	AlgrnGalal Daza
E0	4131	AlgrnGalal Daza Gch
F0	4132	AlgrnGalal Taka Drt
F#0	4133	AlgrnGalal Taka Gch
G0	3343	Tunisian Tabel Dom1
G#0	3344	Tunisian Tabel Dom2
A0	3345	Tunisian Tabel Dom3
A#0	3314	Tunisian Tabla Sak
B0	3315	Tunisian Tabla TakMt
C1	3648	Tnsn Bendir1 Dom1
C#1	3649	Tnsn Bendir1 Dom2
D1	3653	Tnsn Bendir1 TakCls1
D#1	3650	Tnsn Bendir1 TakOpn1
E1	3651	Tnsn Bendir1 TakOpn2
F1	3657	Tnsn Bendir1 TakMute
F#1	3654	Tnsn Bendir1 TakCls2
G1	3655	Tnsn Bendir1 TakCls3
G#1	3656	Tnsn Bendir1 TakCls4
A1	3652	Tnsn Bendir1 TakOpn3
A#1	3658	Tnsn Bendir1 Roll
B1	3670	Tnsn Bendir2 DomRoll
C2	3659	Tnsn Bendir2 Dom Opn
C#2	3660	Tnsn Bendir2 Dom Cls
D2	3661	Tnsn Bendir2 TakSml
D#2	3662	Tnsn Bendir2 TakOpn1
E2	3663	Tnsn Bendir2 TakOpn2
F2	3669	Tnsn Bendir2 TakMute
F#2	3666	Tnsn Bendir2 TakCls1
G2	3667	Tnsn Bendir2 TakCls2
G#2	3668	Tnsn Bendir2 TakCls3
A2	3664	Tnsn Bendir2 TakOpn3
A#2	3665	Tnsn Bendir2 TakOpn4
B2	4009	Darbouka Hand Finger Roll
C3	3998	Darbouka Dom
C#3	3999	Darbouka Tak Close1
D3	4000	Darbouka Tak Close2
D#3	4003	Darbouka Tak Open1
E3	4004	Darbouka Tak Open2
F3	4005	Darbouka Tak Open3
F#3	4006	Darbouka Tak Open4
G3	4001	Darbouka Tak Close3
G#3	4002	Darbouka Tak Close4
A3	4007	Darbouka Tak Open5
A#3	4008	Darbouka Tak Open6
B3	4010	Darbouka Hand Roll
C4	3671	Mrcn Bendir1 Dom Opn
C#4	3672	Mrcn Bendir1 Dom Cls
D4	3673	Mrcn Bendir1 Tik Opn
D#4	3674	Mrcn Bendir1 TikCls1
E4	3675	Mrcn Bendir1 TikCls2
F4	3676	Mrcn Bendir1 Zim
F#4	3677	Mrcn Bendir2 Dom Opn
G4	3678	Mrcn Bendir2 Dom Cls
G#4	3680	Mrcn Bendir2 TikCls1
A4	3681	Mrcn Bendir2 TikCls2
A#4	3679	Mrcn Bendir2 Tik Opn
B4	3682	Mrcn Bendir2 Zim
C5	3683	Mrcn Bendir3 Dom Opn
C#5	3684	Mrcn Bendir3 Edg Opn
D5	3686	Mrcn Bendir3 Tik Cls
D#5	3685	Mrcn Bendir3 Tik Opn
E5	3687	Mrcn Bendir3 Tik Stp
F5	3349	Moroccan Tamtam Lo
F#5	3350	Moroccan Tamtam Hi
G5	4094	MoroccanTaarija1 Dom
G#5	4095	MoroccanTaarija1 Tik
A5	4096	MoroccanTaarija2 Dom
A#5	4097	MoroccanTaarija2 Tik
B5	4098	MoroccanTaarija3 Dom
C6	3688	AlgrnBendir Deza

New Khaligi Kit 1

Note	Wave Number	Wave Name
C#0	3012	Khalg Bongo Lo Dom
D0	3014	Khalg Bongo Lo Tak
D#0	3013	Khalg Bongo Lo Sak
E0	3015	Khalg Bongo Hi Snap1
F0	3017	Khalg Bongo Hi Sak
F#0	3016	Khalg Bongo Hi Snap2
G0	3377	Merjaf Group1 Dom
G#0	3378	Merjaf Group1 Sak
A0	3379	Merjaf Group2 Dom
A#0	3380	Merjaf Group2 Tak
B0	3381	Merjaf Group2 Sak
C1	4040	Doholla1 Dom
C#1	4041	Doholla1 Tak
D1	4042	Doholla1 Sak
D#1	3304	Tabla3 Dom
E1	3305	Tabla3 Tak
F1	3306	Tabla3 Sak
F#1	2961	Khalg Conga1 Lo Dom1
G1	3307	Tabla4 Dom
G#1	3308	Tabla4 Tak
A1	3309	Tabla4 Tik
A#1	3310	Tabla4 Sak
B1	2898	Khaligi Hand Clap1
C2	4099	Marad Group1 Dom
C#2	4100	Marad Group1 Tak
D2	4101	Marad Group1 Sak
D#2	4102	Marad Group2 Dom
E2	4103	Marad Group2 Tak
F2	4104	Marad Group2 Sak
F#2	4105	Marad1 Dom
G2	4106	Marad1 Tak
G#2	4107	Marad1 Sak
A2	4108	Marad2 Dom
A#2	4109	Marad2 Tak
B2	4110	Marad2 Sak
C3	3725	Sajat1 Open
C#3	3726	Sajat1 Close
D3	3727	Sajat2 Open
D#3	3728	Sajat2 Close
E3	4111	Sigal Marad Dom
F3	4112	Sigal Marad Tak
F#3	4113	Sigal Marad Sak
G3	3781	Req Dom1
G#3	3785	Req Sajat
A3	3783	Req Open
A#3	3788	Req Roll
B3	2964	Khalg Conga2 Hi Dom
C4	2965	Khalg Conga2 Hi Sak
C#4	3552	Taar Barashim3 Dom
D4	3553	Taar Barashim3 Sak
D#4	3554	Taar Barashim4 Dom
E4	3555	Taar Barashim4 Sak
F4	3557	Sgl TaarBarashim Dom
F#4	3559	Sgl TaarBarashim Tak
G4	3558	Sgl TaarBarashim Sak
G#4	3556	Taar Barashim Shake
A4	4176	Manjoor Normal
A#4	3382	Zeer1 Dom
B4	3383	Zeer1 Flam
C5	3384	Zeer2 Dom1
C#5	3386	Zeer2 Flam
D5	3385	Zeer2 Dom2
D#5	3389	Zeer3 Tak1
E5	3387	Zeer3 Dom1
F5	3388	Zeer3 Dom2
F#5	3390	Zeer3 Tak2
G5	3331	Tabol Low Dom
G#5	3332	Tabol Low Tak
A5	3333	Tabol Low Sak
A#5	3334	Tabol High Dom
B5	3335	Tabol High Tak
C6	3336	Tabol High Sak

New Khaligi Kit 2

Note	Wave Number	Wave Name
C#0	3725	Sajat1 Open
D0	3726	Sajat1 Close
D#0	3727	Sajat2 Open
E0	3728	Sajat2 Close
F0	4111	Sigal Marad Dom
F#0	3783	Req Open
G0	3785	Req Sajat
G#0	3781	Req Dom1
A0	3780	Req Sak
A#0	3788	Req Roll
B0	4176	Manjoor Normal
C1	4043	Doholla2 Dom
C#1	4044	Doholla2 Tak
D1	4045	Doholla2 Sak
D#1	3391	Merwas Group Dom
E1	3392	Merwas Group Sak
F1	3393	Merwas Group Tak
F#1	3394	Merwas Dom
G1	3395	Merwas Sak
G#1	3396	Merwas Tak
A1	2899	Khaligi Hand Clap2
A#1	2900	Khaligi Hand Clap3
B1	2901	Khaligi Hand Clap4
C2	4099	Marad Group1 Dom
C#2	4100	Marad Group1 Tak
D2	4101	Marad Group1 Sak
D#2	4102	Marad Group2 Dom
E2	4103	Marad Group2 Tak
F2	4104	Marad Group2 Sak
F#2	3397	Kaser Flam
G2	3398	Kaser Dom1
G#2	3400	Kaser Sak1
A2	3399	Kaser Dom2
A#2	3401	Kaser Sak2
B2	3556	Taar Barashim Shake
C3	3402	Rana Low1 Dom
C#3	3403	Rana Low2 Dom
D3	3404	Rana Low1 Tak
D#3	3405	Rana Low2 Tak
E3	3406	Rana Low1 Sak
F3	3407	Rana Low2 Sak
F#3	3408	Rana High1 Dom
G3	3409	Rana High2 Dom
G#3	3410	Rana High1 Tak
A3	3411	Rana High2 Tak
A#3	3412	Rana High1 Sak
B3	3413	Rana High2 Sak
C4	3414	Medando1 Dom
C#4	3416	Medando2 Dom
D4	3415	Medando1 Sak
D#4	3417	Medando2 Sak
E4	3418	Medando Flam
F4	3419	Mesando Dom
F#4	3420	Mesando Sak1
G4	3539	Jahla Group Dom
G#4	3540	Jahla Group Sak
A4	3541	Jahla Dom
A#4	3542	Jahla Sak
B4	3049	Tanak Dom1
C5	3050	Tanak Dom2
C#5	2964	Khalg Conga2 Hi Dom
D5	2959	Khalg Conga1 Hi Sak1
D#5	2960	Khalg Conga1 Hi Sak2
E5	2962	Khalg Conga1 Lo Dom2
F5	2963	Khalg Conga1 Lo Sak1
F#5	3425	Ras Low Dom
G5	3427	Ras High Dom
G#5	3426	Ras Low Sak
A5	4111	Sigal Marad Dom
A#5	4112	Sigal Marad Tak
B5	4113	Sigal Marad Sak
C6	3451	Kasoor Dom

New Iranian Kit 1

Note	Wave Number	Wave Name
C0	3528	Udho Tom Hole
C#0	3530	Udho Back1
D0	3532	Udho Chap Body
D#0	3533	Udho Chap Skin
E0	3534	Udho Chap Top Hole
F0	3694	Iran Bendir1 Chap1
F#0	3696	Iran Bendir1 Rim
G0	3693	Iran Bendir1 Slap
G#0	3698	Iran Bendir1 Back
A0	3697	Iran Bendir1 Bck&Chp
A#0	3695	Iran Bendir1 Chap2
B0	3699	Iran Bendir1 Roll
C1	3868	Tombak Tom1
C#1	3877	Tombak Chap1
D1	3878	Tombak Chap2
D#1	3879	Tombak Back1
E1	3882	Tombak Nail Swish
F1	3881	Tombak Pelang
F#1	3886	Tombak Roll Bfingers
G1	3883	Tombak Flam1
G#1	3884	Tombak Flam2
A1	3885	Tombak Flam & Back
A#1	3880	Tombak Back2
B1	3876	Tombak Slap
C2	3790	Daf Tom
C#2	3797	Daf Chain Up1
D2	3795	Daf Back1
D#2	3798	Daf Chain Down1
E2	3801	Daf Chap No Chain
F2	3802	Daf Roll
F#2	3803	Daf Roll Chain
G2	3804	Daf Roll Rim
G#2	3792	Daf Slap Open
A2	3793	Daf Slap Mute
A#2	4047	Naghareh Roll
B2	4046	Naghareh Tom
C3	4049	Naghareh Snap
C#3	4048	Naghareh Chap
D3	4051	Naghareh Flam 3Fing
D#3	4050	Naghareh Back
E3	3353	Dohol Gorz
F3	3354	Dohol Gorz & Tarkeh
F#3	3355	Dohol Tarkeh1
G3	3356	Dohol Tarkeh2
G#3	3786	Req Tom & Zang
A3	3787	Req Chap Zang Open
A#3	3784	Req Slap
B3	3894	Tombak Tempo Roll
C4	3887	Tombak Tempo Tom
C#4	3893	Tombak Tempo ChapFlm
D4	3891	Tombak Tempo Back
D#4	3892	Tombak Tempo Back Mt
E4	3889	Tombak Tempo Chap
F4	3890	Tombak Tempo Chap Mt
F#4	3888	Tombak Tempo Slap
G4	4013	Zarb1 Back
G#4	4014	Zarb1 Flam Open
A4	4012	Zarb1 Chap
A#4	4011	Zarb1 Slap
B4	4015	Zarb1 Roll
C5	3808	Dayereh1 Tom
C#5	3809	Dayereh1 Tom Mute
D5	3810	Dayereh1 Back
D#5	3811	Dayereh1 Back Mute1
E5	3812	Dayereh1 Back Mute2
F5	3813	Dayereh1 Snap
F#5	3814	Dayereh1 Chap
G5	3815	Dayereh1 Soft Roll
G#5	3816	Dayereh1 Tom Roll
A5	3817	Dayereh1 Rim Roll
A#5	3823	Dayereh2 Flam Tom
B5	3824	Dayereh2 Flam Back
C6	3692	Iran Bendir1 Tom

New Iranian Kit 2

Note	Wave Number	Wave Name
C1	3020	Iran Bongo Lo Roll
C#1	3025	Iran Bongo Hi Roll
D1	3437	Zangooreh Roll
D#1	3438	Zangooreh Shot
E1	2864	Castanet3 Flam1
F1	2865	Castanet3 Flam2
F#1	2866	Castanet3 LH Normal
G1	2867	Castanet3 LH Mute
G#1	2868	Castanet3 LH&RH Nrmal
A1	2869	Castanet3 LH&RH Mute
A#1	2870	Castanet3 RH Normal
B1	2871	Castanet3 RH Mute
C2	3464	Gosha Naghareh Lo
C#2	3465	Gosha Naghareh LoRim
D2	3466	Gosha Naghareh LoFlm
D#2	3467	Gosha Naghareh Hi1
E2	3468	Gosha Naghareh Hi2
F2	3469	Gosha Naghareh HiRim
F#2	3470	Gosha Naghareh HiFlm
G2	3432	Finger Cymbal Opn LH
G#2	3433	Finger Cymbal Mt LH
A2	3434	Finger Cymbal Opn RH
A#2	3435	Finger Cymbal Mt RH
B2	3436	Finger Cymbal Mt L&R
C3	3700	Iran Bendir2 Tom
C#3	3702	Iran Bendir2 Chap1
D3	3703	Iran Bendir2 Chap2
D#3	3705	Iran Bendir2 Back
E3	3701	Iran Bendir2 Slap
F3	3706	Iran Bendir2 Bak Rim
F#3	3704	Iran Bendir2 Chap Mt
G3	3709	Iran Bendir2 FlamBck
G#3	3707	Iran Bendir2 Flam
A3	3708	Iran Bendir2 FlamTom
A#3	3711	Iran Bendir2 RimRoll
B3	3710	Iran Bendir2 Roll
C4	3898	Tempo Chap Tom
C#4	3899	Tempo Chap1
D4	3896	Tempo Tom Mute
D#4	3897	Tempo Tom Slap
E4	3900	Tempo Chap2
F4	3895	Tempo Tom
F#4	3903	Tempo Back1
G4	3904	Tempo Back2
G#4	3905	Tempo Back Rim
A4	3909	Tempo Flam Bak
A#4	3907	Tempo Flam
B4	3910	Tempo Roll
C5	3908	Tempo Flam Tom
C#5	3901	Tempo Chap Rim
D5	3902	Tempo Chap Rim Mute
D#5	3906	Tempo Snap Nail
E5	3913	Tempo Gliss Down
F5	3912	Tempo Gliss Up
F#5	3911	Tempo Rim Roll
G5	3018	Iran Bongo Lo Tom
G#5	3021	Iran Bongo Hi Bk LH
A5	3022	Iran Bongo Hi Bk RH
A#5	3023	Iran Bongo Hi Mt RH
B5	3019	Iran Bongo Lo Flm Tm
C6	3024	Iran Bongo Hi Flm Bk

Darbuka Sagat Riq

Note	Wave Number	Wave Name
G1	3720	Sagat2 Close
G#1	3722	Sagat3 Close
A1	3721	Sagat3 Open
A#1	3724	Sagat4 Close
B1	3723	Sagat4 Open
C2	3988	Darbuka3 Noise FX1
C#2	3989	Darbuka3 Noise FX2
D2	3990	Darbuka3 Noise FX3
D#2	3991	Darbuka3 Noise FX4
E2	3992	Darbuka3 Noise FX5
F2	3993	Darbuka3 Noise FX6
F#2	3994	Darbuka3 Noise FX7
G2	3983	Darbuka3 Rak1
G#2	3984	Darbuka3 Rak2
A2	3987	Darbuka3 Feel Heel
A#2	3975	Darbuka3 Dom & Tak
B2	3985	Darbuka3 Gliss Down
C3	3986	Darbuka3 Gliss Up
C#3	3966	Darbuka2 TakLIndxFng
D3	3967	Darbuka2 TakRIndxFng
D#3	3965	Darbuka2 Sak1
E3	3968	Darbuka2 TakLRingFng
F3	3969	Darbuka2 TakRRingFng
F#3	3970	Darbuka2 Tap1
G3	3971	Darbuka2 Tap2
G#3	3972	Darbuka2 Flam1
A3	3973	Darbuka2 Flam2
A#3	3974	Darbuka2 Tak Roll
B3	3985	Darbuka3 Gliss Down
C4	3986	Darbuka3 Gliss Up
C#4	3980	Darbuka3 Sak1
D4	3981	Darbuka3 Sak2
D#4	3982	Darbuka3 Sak3
E4	3976	Darbuka3 Tak Finger
F4	3977	Darbuka3 Tak BothHnd
F#4	3978	Darbuka3 Tak Close
G4	3979	Darbuka3 Tak Mute
G#4	3995	Darbuka3 Dom Roll
A4	3996	Darbuka3 Sak Roll
A#4	3997	Darbuka3 RllTakToDom
B4	3770	Riq3 Dom Close
C5	3769	Riq3 Dom Open
C#5	3772	Riq3 Tak Close1
D5	3771	Riq3 Tak Open
D#5	3773	Riq3 Tak Close2
E5	3774	Riq3 Tak Snouj
F5	3768	Riq2 Sak
F#5	3775	Riq3 Snouj Close1
G5	3776	Riq3 Snouj Close2
G#5	3778	Riq3 Flam
A5	3777	Riq3 Sak
A#5	3779	Riq3 Snouj Roll

Bodhran&Cajon Kit

Note	Wave Number	Wave Name
C0	4231	Conga T8
C#0	3592	Bodhran Opn Center
D0	3593	Bodhran Opn Mid
D#0	3594	Bodhran Opn Edge
E0	3595	Bodhran Stck Mt Cent
F0	3596	Bodhran Stck Mt Mid
F#0	3597	Bodhran Stck Mt Edge
G0	3598	Bodhran Finger Mt
G#0	3599	Bodhran Palm Mt
A0	3600	Bodhran Op Rim Clk
A#0	3601	Bodhran Mt Rim Clk
B0	3602	Bodhran Mt Rm Clk Rs
C1	3603	Bodhran OpRimClk Rs
C#1	3604	Bodhran Grace Note
D1	3605	Bodhran Harmonics
D#1	3606	Bodhran Drags
E1	3607	Bodhran Mute Bend
F1	3608	Bodhran Palm Slide1
F#1	3609	Bodhran Palm Slide2
G1	3610	Bodhran Palm Slide3
G#1	3611	Bodhran Palm Slide4
A1	3612	Bodhran Stck SldStrt
A#1	3613	Bodhran Stck Sld Mid
B1	3614	Bodhran Stck Sld End
C2	3161	Cajon3 Vari 1
C#2	3162	Cajon3 Vari 2
D2	3163	Cajon3 Vari 3
D#2	3164	Cajon3 Vari 4
E2	3165	Cajon3 Vari 5
F2	3166	Cajon3 Vari 6
F#2	3167	Cajon3 Vari 7
G2	3168	Cajon3 Vari 8
G#2	3169	Cajon3 Vari 9
A2	3170	Cajon3 Vari 10
A#2	3171	Cajon3 Vari 11
B2	3172	Cajon3 Vari 12
C3	3173	Cajon3 Vari 13
C#3	3174	Cajon3 Vari 14
D3	3175	Cajon3 Vari 15
D#3	3176	Cajon3 Vari 16
E3	3177	Cajon3 Vari 17
F3	3178	Cajon3 Vari 18
F#3	3179	Cajon3 Vari 19
G3	3180	Cajon3 Vari 20
G#3	3181	Cajon3 Vari 21
A3	3182	Cajon3 Vari 22
A#3	3183	Cajon3 Vari 23
B3	3184	Cajon3 Vari 24
C4	3185	Cajon3 Vari 25
C#4	3186	Cajon3 Vari 26
D4	3187	Cajon3 Vari 27
D#4	3188	Cajon3 Vari 28
E4	3189	Cajon3 Vari 29
F4	3190	Cajon3 Vari 30
F#4	3191	Cajon3 Vari 31
G4	3192	Cajon3 Vari 32
G#4	3193	Cajon3 Vari 33
A4	3194	Cajon3 Vari 34
A#4	3195	Cajon3 Vari 35
B4	3196	Cajon3 Vari 36
C5	3197	Cajon3 Vari 37
C#5	3198	Cajon3 Vari 38
D5	3199	Cajon3 Vari 39
D#5	3200	Cajon3 Vari 40
E5	3201	Cajon3 Vari 41
F5	3202	Cajon3 Vari 42
F#5	3203	Cajon3 Vari 43
G5	3204	Cajon3 Vari 44
G#5	3205	Cajon3 Vari 45
A5	3206	Cajon3 Vari 46
A#5	3207	Cajon3 Vari 47
B5	3208	Cajon3 Vari 48
C6	3209	Cajon3 Vari 49

Bones&Spoons Kit

Note	Wave Number	Wave Name
C1	4134	Bones 1
C#1	4135	Bones 2
D1	4136	Bones 3
D#1	4137	Bones 4
E1	4138	Bones 5
F1	4139	Bones 6
F#1	4140	Bones 7
G1	4141	Bones 8
G#1	4142	Bones 9
A1	4143	Bones 10
A#1	4144	Bones 11
B1	4145	Bones 12
C2	4146	Bones Triplet
C3	4147	Spoons 1
C#3	4148	Spoons 2
D3	4149	Spoons 3
D#3	4150	Spoons 4
E3	4151	Spoons 5
F3	4152	Spoons 6
F#3	4153	Spoons 7
G3	4154	Spoons 8
G#3	4155	Spoons 9
A3	4156	Spoons 10
A#3	4157	Spoons 11
B3	4158	Spoons 12
C4	4159	Spoons 13
C#4	4160	Spoons 14
D4	4161	Spoons 15
D#4	4162	Spoons 16
E4	4163	Spoons 17
F4	4164	Spoons 18
F#4	4165	Spoons 19
G4	4166	Spoons 20
G#4	4167	Spoons 21
A4	4168	Spoons 22
A#4	4169	Spoons 23
B4	4170	Spoons 24
C5	4171	Spoons 25
C#5	4172	Spoons Roll 1
D5	4173	Spoons Roll 2
D#5	4174	Spoons Roll 3
E5	4175	Spoons Roll 4

Highland Snares

Note	Wave Number	Wave Name
C2	4526	Bd GranCasaA Open St
C#2	6222	Hand Cymbal Mute St
D2	6171	Crash1 St
C3	5305	Hiland Snare
C#3	5306	Hiland Snare Rim
D3	5307	Hiland Snare Open
D#3	5308	Hiland Snare Flam
E3	5309	Hiland Snare ShtRll
F3	5311	Hiland Snare Roll
F#3	5310	Hiland Snare Sfz
G3	5311	Hiland Snare Roll

Experimental Work

Note	Wave Number	Wave Name
C0	2277	Mini Brip2
C#0	2276	Mini Brip1
D0	2278	Mini Brip3
D#0	2279	Mini Brip4
E0	2280	Mini Brip5
F0	2281	Mini Brip6
F#0	2491	Bell FX1
G0	2492	Bell FX2
G#0	2500	Electric Perc4
A0	2502	Electric Perc6
A#0	2511	Electric Perc15
B0	2501	Electric Perc5
C1	2498	Electric Perc2
C#1	2499	Electric Perc3
D1	2503	Electric Perc7
D#1	2504	Electric Perc8
E1	2505	Electric Perc9
F1	2506	Electric Perc10
F#1	2510	Electric Perc14
G1	2509	Electric Perc13
G#1	2397	Neo Seq Em-3
A1	2206	Spectrum1
A#1	2208	Spectrum3
B1	2207	Spectrum2
C2	2403	Whisper Seq Bb
C#2	2480	Digi Voice Mod
D2	2338	Moving Chime St
D#2	2335	Engine Room St
E2	2447	Raspberry
F2	2448	Digi Heli
F#2	2392	Hop FX1
G2	2307	Willow St
G#2	2310	Anemone St
A2	2313	Magnitude St
A#2	2445	Radio Noise
B2	2391	Quiek
C3	2378	Stab Giant
C#3	2374	HH Hit
D3	2379	Stab Hard
D#3	2380	Stab Organ2
E3	2381	Stab Aah
F3	2382	Hit Uhh
F#3	2383	Hit Orchestra2
G3	2375	Hit Orchestra1
G#3	2376	Hit Brass
A3	2366	Orchestra Hit1 St
A#3	2369	Orchestra Hit2 St
B3	1369	Brass Sect Fall
C4	782	Play FX Mix
C#4	782	Play FX Mix
D4	2775	ElectricGtr FX23
D#4	2787	Acoustic Bass FX04
E4	2788	Acoustic Bass FX05
F4	2784	Acoustic Bass FX01
F#4	2629	Scratch H
G4	2630	Scratch L
G#4	2631	Scratch Down
A4	2632	Scratch Hi F
A#4	2642	Scratch Stop
B4	2611	Tape Rewind
C5	2489	Ripper
C#5	2494	Noise Burst
D5	2495	Zap1
D#5	2496	Zap2
E5	2512	Hi Q1
F5	2513	Hi Q2
F#5	2610	Bomb
G5	2612	FxGun1
G#5	2341	Motion Beam
A5	2304	Birch St
A#5	2138	Tri Wave
B5	2259	FM Bass2
C6	2145	FM Metal2

Flix Flux FM

Note	Wave Number	Wave Name
C0	4580	Bd T8-1
C#0	5381	Sd T8 Rim
D0	5377	Sd T8-2
D#0	4188	Electric Clap1
E0	5326	Sd Elec11
F0	5322	Sd Elec7
F#0	5379	Sd T8-4
G0	4638	Bd Elec2
G#0	5376	Sd T8-1
A0	4715	Bd HipHop8
A#0	5378	Sd T8-3
B0	4716	Bd HipHop9
C1	4715	Bd HipHop8
C#1	5392	Sd AnSm Rim
D1	5492	Sd HipHop4
D#1	4187	Clap AnSm
E1	5493	Sd HipHop5
F1	6123	Tom T8
F#1	5780	HH Closed T8-1
G1	6123	Tom T8
G#1	5781	HH Open T8-1
A1	6123	Tom T8
A#1	5781	HH Open T8-1
B1	6123	Tom T8
C2	6123	Tom T8
C#2	6179	Crash3
D2	6123	Tom T8
D#2	6329	Ride T9-1
E2	6293	Splash1 St
F2	6281	Ride Cup Mono
F#2	2845	Tambourine1 Hit
G2	6305	Crash T8-1
G#2	4242	Cowbell T8
A2	6283	China1 St
A#2	4242	Cowbell T8
B2	6225	Ride1 St
C3	4231	Conga T8
C#3	4231	Conga T8
D3	4231	Conga T8
D#3	4231	Conga T8
E3	4231	Conga T8
F3	2929	Conga1 Hi Slap
F#3	2928	Conga1 Hi Slap Open
G3	2926	Conga1 Hi Open 2
G#3	3027	Timbale1 Hi 1
A3	3064	Cabasa1A 2
A#3	3059	Maracas1 Slur
B3	2465	Fx Female Voice St
C4	2417	Portamento Lead Seq
C#4	2505	Electric Perc9
D4	2825	Shaker Hip1
D#4	4276	Claves T8-1
E4	2512	Hi Q1
F4	2513	Hi Q2
F#4	2826	Shaker Hip2
G4	2511	Electric Perc15
G#4	2884	Triangle1 Mute
A4	2883	Triangle1 Open
A#4	2828	Shaker Hip4
B4	2489	Ripper
C5	4640	Bd Elec4
C#5	5408	Sd Hip1
D5	5324	Sd Elec9
D#5	5321	Sd Elec6
E5	5490	Sd HipHop2
F5	4646	Bd ElecGate
F#5	5782	HH Closed T8-2
G5	4635	Bd ThickSkin
G#5	5783	HH Open T8-2
A5	4608	Bd Break Heavy
A#5	5783	HH Open T8-2
B5	4605	Bd Break Deep
C6	4603	Bd R&B2

FM Techre

Note	Wave Number	Wave Name
C0	4638	Bd Elec2
C#0	2642	Scratch Stop
D0	5237	Sd Brush Swir L
D#0	5229	Sd Brush Med R
E0	5236	Sd Brush Swir St
F0	5215	Sd Roll Mono
F#0	2263	FM Bass6
G0	2621	Seashore
G#0	2500	Electric Perc4
A0	4643	Bd ElecComp3
A#0	4783	Sd Strong R2
B0	4638	Bd Elec2
C1	4636	Bd Slimy
C#1	3034	Timbale1 Paila H
D1	4959	Sd Piccolo
D#1	4187	Clap AnSm
E1	5325	Sd Elec10
F1	2238	Mg Bass2
F#1	2513	Hi Q2
G1	2238	Mg Bass2
G#1	2503	Electric Perc7
A1	6123	Tom T8
A#1	5783	HH Open T8-2
B1	6123	Tom T8
C2	6123	Tom T8
C#2	6179	Crash3
D2	6123	Tom T8
D#2	6281	Ride Cup Mono
E2	6281	Ride Cup Mono
F2	6281	Ride Cup Mono
F#2	2638	Scratch Sd F
G2	6256	Ride Cup1 RL
G#2	2503	Electric Perc7
A2	6179	Crash3
A#2	2324	Hi-Lo
B2	6287	China2
C3	2141	Ring Mod
C#3	2504	Electric Perc8
D3	2141	Ring Mod
D#3	2503	Electric Perc7
E3	2507	Electric Perc11
F3	3052	Paila H
F#3	3052	Paila H
G3	2392	Hop FX1
G#3	2393	Hop FX2
A3	2629	Scratch H
A#3	2632	Scratch Hi F
B3	2496	Zap2
C4	2446	LFO Seq
C#4	2446	LFO Seq
D4	2216	Mini Bass3a
D#4	2391	Quiek
E4	2334	Digi Breath
F4	2448	Digi Heli
F#4	2503	Electric Perc7
G4	2149	FM Organ1
G#4	3431	Tibetan Bowl
A4	3431	Tibetan Bowl
A#4	3563	Segal Dom
B4	2337	Engine Room R
C5	2504	Electric Perc8
C#5	636	Steel1 Slide St
D5	2277	Mini Brip2
D#5	2207	Spectrum2
E5	2280	Mini Brip5
F5	2282	Noise
F#5	4600	Bd D&B1
G5	2207	Spectrum2
G#5	2316	SabreTone
A5	2510	Electric Perc14
A#5	2504	Electric Perc8
B5	2448	Digi Heli
C6	2912	Wind Chime 1

The Green Flash

Note	Wave Number	Wave Name
C0	2446	LFO Seq
C#0	2321	Trance Choir
D0	3431	Tibetan Bowl
D#0	2642	Scratch Stop
E0	4632	Bd Analog Tight
F0	2380	Stab Organ2
F#0	2618	Door Squeak
G0	2445	Radio Noise
G#0	2618	Door Squeak
A0	4635	Bd ThickSkin
A#0	2794	Electric Bass FX 02
B0	2789	Acoustic Bass FX06
C1	4705	Electro BD 2 Mn
C#1	5414	Sd Hip Rim3
D1	5411	Sd Hip Gate
D#1	4859	Sd SonA S11-4
E1	2561	Electric Fx Perc6
F1	6135	Tom Dist Lo
F#1	5766	HH Closed T9
G1	6134	Tom Dist Hi
G#1	5517	HH Closed 2St
A1	6106	Tom T9 Hi
A#1	5767	HH Open T9
B1	6106	Tom T9 Hi
C2	6106	Tom T9 Hi
C#2	6283	China1 St
D2	6106	Tom T9 Hi
D#2	6293	Splash1 St
E2	6303	Crash T9-1
F2	6329	Ride T9-1
F#2	3088	Pandeiro1 Tip
G2	4260	Electric Tambourine 1
G#2	2513	Hi Q2
A2	4556	Bd Gate
A#2	2513	Hi Q2
B2	2786	Acoustic Bass FX03
C3	2784	Acoustic Bass FX01
C#3	2281	Mini Brip6
D3	2276	Mini Brip1
D#3	2277	Mini Brip2
E3	2967	Quinto1 Slap
F3	3288	Tabla1 Bya
F#3	3272	Djembe1 Edge
G3	3289	Tabla1 Nah
G#3	3545	Barasim Tak
A3	2504	Electric Perc8
A#3	2509	Electric Perc13
B3	2392	Hop FX1
C4	2341	Motion Beam
C#4	2496	Zap2
D4	2480	Digi Voice Mod
D#4	1909	Human Whistle
E4	2479	Digital Wind
F4	4286	Analog Click
F#4	5780	HH Closed T8-1
G4	5431	Sd FM
G#4	5570	HH Half Open2 RL
A4	4276	Claves T8-1
A#4	5781	HH Open T8-1
B4	6346	Reverse Cymbal1
C5	4632	Bd Analog Tight
C#5	4630	Bd TekPower
D5	4566	Bd T9 Hd3
D#5	4627	Bd ZapHard
E5	4636	Bd Slimy
F5	4609	Bd Break Hard
F#5	5178	Sd BreakRim
G5	4747	Sd Soul St1-3
G#5	4964	Sd Ambience
A5	4943	Sd Rock Mute1 R
A#5	5428	Sd Cut
B5	5403	Sd D&B3
C6	5422	Sd FX1

Slow Fast

Note	Wave Number	Wave Name
C1	4707	Electro BD 4 St
C#1	5340	Electric Snare
D1	5348	Sd Long Snare Wire
D#1	4192	Clap Short Ambi St
E1	5331	Echo Snare St
F1	6164	Powerful Tom Mid St
F#1	5869	Elec HH 1 Closed
G1	6165	Powerful Tom Low St
G#1	5871	Elec HH 2 Closed
A1	6163	Powerful Tom High St
A#1	5870	Elec HH 1 Open
B1	6167	Fine Light Tom St
C2	6162	Light Tom Low St
C#2	6327	FX Crash St
D2	6161	Light Tom High St
D#2	6342	Clang Ride St
E2	6325	Crackle Crash St
F2	6343	Smith Ride St
F#2	2850	Tambourine FX 1
G2	6326	Electric Crash St
G#2	2851	Tambourine FX 2
A2	6328	Phase Crash St
A#2	4226	Snap & Clap St
B2	6345	Ride Hip Hop St
C3	3007	Bongo Extent 1 St
C#3	3009	Bongo Extent 3 St
D3	3008	Bongo Extent 2 St
D#3	3007	Bongo Extent 1 St
E3	3261	Stomp St
F3	2593	Vocal Snare St
F#3	2594	Vocal Ambi SE St
G3	2595	Vocal Shout Yeah St
G#3	2596	Vocal Shout Go St
A3	2833	Shaker Muffled 1 St
A#3	2834	Shaker Muffled 2 St
B3	2605	Glitch 8
C4	2605	Glitch 8
C#4	5872	Powerful HH Closed
D4	5873	Powerful HH Open
D#4	3267	Ethnic Perc 6
E4	3268	Ethnic Perc 7
F4	3269	Ethnic Perc 8
F#4	2597	Rainmaker St
G4	3266	Ethnic Perc 5
G#4	3265	Ethnic Perc 4
A4	4225	Snap Digital St
A#4	4227	Snap Long Ambi St
B4	4228	Snap Smith Snap St
C5	2913	Wind Chime 2 St
C#5	5338	Elec Jazz Snare St
D5	5339	Elec Tight Snare St
D#5	5341	Clang Snare St
E5	5342	Ambi Snare
F5	5343	Snare Roll OneShot
F#5	4625	Clink BD St
G5	5344	Fine Snare St
G#5	5345	Elec Light Snare St
A5	4624	Electric BD St
A#5	5346	Crackle Snare St
B5	2609	T8 Bass SE St
C6	2608	T8 Bend

Smartbar Funk

Note	Wave Number	Wave Name
B0	4700	House BD 1 St
C1	4701	House BD 2 St
C#1	4338	House Misc 1 St
D1	5478	House SD 3 St
D#1	4207	House Clap 3 St
E1	5335	Fresh Snare 2
F1	6152	House Tom Lo L Mn
F#1	5852	House HH 1 St
G1	6151	House Tom Lo H Mn
G#1	5853	House HH 2 Mn
A1	6150	House Tom Mid L Mn
A#1	5856	House OHH 2 St
B1	6149	House Tom Mid M Mn
C2	6148	House Tom Mid H Mn
C#2	6319	House Crash St
D2	6147	House Tom Hi L Mn
D#2	6337	House Ride St
E2	6146	House Tom Hi H Mn
F2	5854	House HH 3 Mn
F#2	2588	House Fx1 Mn
G2	5855	House OHH 1 St
G#2	3230	HipHop Cowbell 1 Mn
A2	4208	House Clap 4 St
A#2	4205	House Clap 1 St
B2	2590	House Fx3 St
C3	4341	House Misc 4 St
C#3	4339	House Misc 2 St
D3	5480	House SD 5 St
D#3	5479	House SD 4 St
E3	4206	House Clap 2 St
F3	5476	House SD 1 St
F#3	4702	House BD 3 St
G3	4703	House BD 4 Mn
G#3	4284	House Cabasa1 Mn
A3	4285	House Cabasa2 Mn
A#3	2840	House Shaker2 Mn
B3	2839	House Shaker1 Mn
C4	2842	House Shaker Long Mn
C#4	4343	House Misc 6 Mn
D4	3117	House Guiro Mn
D#4	2878	House WB3 Mn
E4	2877	House WB2 Mn
F4	2876	House WB1 Mn
F#4	4340	House Misc 3 St
G4	4292	House Perc St
G#4	4342	House Misc 5 St
A4	4281	House Triangle Mn

Fusion Science

Note	Wave Number	Wave Name
B0	4700	House BD 1 St
C1	4701	House BD 2 St
C#1	4338	House Misc 1 St
D1	5478	House SD 3 St
D#1	4207	House Clap 3 St
E1	5472	EDM SD 3 St
F1	6152	House Tom Lo L Mn
F#1	5852	House HH 1 St
G1	6151	House Tom Lo H Mn
G#1	5853	House HH 2 Mn
A1	6150	House Tom Mid L Mn
A#1	5856	House OHH 2 St
B1	6149	House Tom Mid M Mn
C2	6148	House Tom Mid H Mn
C#2	6319	House Crash St
D2	6147	House Tom Hi L Mn
D#2	6337	House Ride St
E2	6146	House Tom Hi H Mn
F2	5854	House HH 3 Mn
F#2	2588	House Fx1 Mn
G2	5855	House OHH 1 St
G#2	3230	HipHop Cowbell 1 Mn
A2	4208	House Clap 4 St
A#2	4205	House Clap 1 St
B2	2590	House Fx3 St
C3	4341	House Misc 4 St
C#3	4339	House Misc 2 St
D3	5480	House SD 5 St
D#3	5479	House SD 4 St
E3	4206	House Clap 2 St
F3	5476	House SD 1 St
F#3	4702	House BD 3 St
G3	4703	House BD 4 Mn
G#3	4284	House Cabasa1 Mn
A3	4285	House Cabasa2 Mn
A#3	2840	House Shaker2 Mn
B3	2839	House Shaker1 Mn
C4	2842	House Shaker Long Mn
C#4	4343	House Misc 6 Mn
D4	3117	House Guiro Mn
D#4	2878	House WB3 Mn
E4	2877	House WB2 Mn
F4	2876	House WB1 Mn
F#4	4340	House Misc 3 St
G4	4292	House Perc St
G#4	4342	House Misc 5 St
A4	4281	House Triangle Mn

Kreuzberg Funk

Note	Wave Number	Wave Name
B0	4705	Electro BD 2 Mn
C1	4705	Electro BD 2 Mn
C#1	4344	Electro Misc 01 M
D1	5481	Electro SD 1 Mn
D#1	4210	Electro Clap 2 St
E1	5483	Electro SD 3 Mn
F1	6158	Electro Tom Lo L Mn
F#1	5859	Electro HH 3 St
G1	6157	Electro Tom Lo H Mn
G#1	5860	Electro HH 4 St
A1	6156	Electro Tom Mid L Mn
A#1	5863	Electro OHH 3 Mn
B1	6155	Electro Tom Mid H Mn
C2	6154	Electro Tom Hi L Mn
C#2	6320	Electro Crash 1 St
D2	6153	Electro Tom Hi H Mn
D#2	6338	Electro Ride Mn
E2	5862	Electro OHH 2 St
F2	5858	Electro HH 2 St
F#2	5861	Electro OHH 1 St
G2	5857	Electro HH 1 St
G#2	6321	Electro Crash 2 St
A2	4345	Electro Misc 02 St
A#2	4345	Electro Misc 02 St
B2	4346	Electro Misc 03 St
C3	4347	Electro Misc 04 St
C#3	4348	Electro Misc 05 St
D3	4349	Electro Misc 06 St
D#3	4350	Electro Misc 07 St
E3	4297	Brip 2 St
F3	4296	Brip 1 St
F#3	4293	Electro Perc 1 St
G3	4295	Electro Perc 3 St
G#3	4209	Electro Clap 1 St
A3	4351	Electro Misc 08 St
A#3	4704	Electro BD 1 Mn
B3	4706	Electro BD 3 Mn
C4	5482	Electro SD 2 Mn
C#4	5483	Electro SD 3 Mn
D4	2592	Electro Fx St
D#4	5484	Electro SD 4 Mn
E4	4356	Electro Misc 13 St
F4	4355	Electro Misc 12 St
F#4	5485	Electro SD 5 Mn
G4	4354	Electro Misc 11 St
G#4	4352	Electro Misc 09 St
A4	4353	Electro Misc 10 St
A#4	6	CF3 Stretch Soft Mn+

Electro Boo

Note	Wave Number	Wave Name
C0	4715	Bd HipHop8
C#0	4560	Bd T9-1
D0	4595	Bd Brip
D#0	4609	Bd Break Hard
E0	4644	Bd ElecFX1
F0	4646	Bd ElecGate
F#0	4645	Bd ElecFX2
G0	4611	Bd Distortion2
G#0	4635	Bd ThickSkin
A0	4642	Bd ElecComp2
A#0	4638	Bd Elec2
B0	4647	Bd ElecClick
C1	4647	Bd ElecClick
C#1	5355	Sd T9Rim
D1	5327	Sd Elec12
D#1	4179	Clap T9-1
E1	5323	Sd Elec8
F1	6107	Tom T9 Lo
F#1	5766	HH Closed T9
G1	6107	Tom T9 Lo
G#1	5767	HH Open T9
A1	6107	Tom T9 Lo
A#1	5767	HH Open T9
B1	6106	Tom T9 Hi
C2	6106	Tom T9 Hi
C#2	6303	Crash T9-1
D2	6106	Tom T9 Hi
D#2	6329	Ride T9-1
E2	6303	Crash T9-1
F2	6329	Ride T9-1
F#2	4261	Electric Tambourine2
G2	6303	Crash T9-1
G#2	4249	Electric Cowbell
A2	6303	Crash T9-1
A#2	4260	Electric Tambourine1
B2	6329	Ride T9-1
C3	2501	Electric Perc5
C#3	2500	Electric Perc4
D3	2508	Electric Perc12
D#3	2502	Electric Perc6
E3	2497	Electric Perc1
F3	2491	Bell FX1
F#3	2492	Bell FX2
G3	2646	Scratch Attack
G#3	2647	Scratch R&B
A3	3062	Cabasa1A 1-2
A#3	3059	Maracas1 Slur
B3	2510	Electric Perc14
C4	2511	Electric Perc15
C#4	2826	Shaker Hip2
D4	2499	Electric Perc3
D#4	2503	Electric Perc7
E4	2504	Electric Perc8
F4	2505	Electric Perc9
F#4	2506	Electric Perc10
G4	2509	Electric Perc13
G#4	2884	Triangle1 Mute
A4	2883	Triangle1 Open
A#4	4275	Electric Maracas
B4	4279	Electric Triangle
C5	2507	Electric Perc11
C#5	5316	Sd Elec1
D5	5470	EDM SD 1 St
D#5	5325	Sd Elec10
E5	5326	Sd Elec11
F5	5317	Sd Elec2
F#5	5318	Sd Elec3
G5	5319	Sd Elec4
G#5	5320	Sd Elec5
A5	5321	Sd Elec6
A#5	5322	Sd Elec7
B5	4188	Electric Clap1
C6	4189	Electric Clap2

More & More

Note	Wave Number	Wave Name
B0	4705	Electro BD 2 Mn
C1	4707	Electro BD 4 St
C#1	4344	Electro Misc 01 M
D1	5481	Electro SD 1 Mn
D#1	4210	Electro Clap 2 St
E1	5483	Electro SD 3 Mn
F1	6158	Electro Tom Lo L Mn
F#1	5859	Electro HH 3 St
G1	6157	Electro Tom Lo H Mn
G#1	5860	Electro HH 4 St
A1	6156	Electro Tom Mid L Mn
A#1	5863	Electro OHH 3 Mn
B1	6155	Electro Tom Mid H Mn
C2	6154	Electro Tom Hi L Mn
C#2	6320	Electro Crash 1 St
D2	6153	Electro Tom Hi H Mn
D#2	6338	Electro Ride Mn
E2	5862	Electro OHH 2 St
F2	5858	Electro HH 2 St
F#2	5861	Electro OHH 1 St
G2	5857	Electro HH 1 St
G#2	6321	Electro Crash 2 St
A2	4345	Electro Misc 02 St
A#2	4345	Electro Misc 02 St
B2	4346	Electro Misc 03 St
C3	4347	Electro Misc 04 St
C#3	4348	Electro Misc 05 St
D3	4349	Electro Misc 06 St
D#3	4350	Electro Misc 07 St
E3	4297	Brip 2 St
F3	4296	Brip 1 St
F#3	4293	Electro Perc 1 St
G3	4295	Electro Perc 3 St
G#3	4209	Electro Clap 1 St
A3	4351	Electro Misc 08 St
A#3	4704	Electro BD 1 Mn
B3	4706	Electro BD 3 Mn
C4	5482	Electro SD 2 Mn
C#4	5483	Electro SD 3 Mn
D4	2592	Electro Fx St
D#4	5484	Electro SD 4 Mn
E4	4356	Electro Misc 13 St
F4	4355	Electro Misc 12 St
F#4	5485	Electro SD 5 Mn
G4	4354	Electro Misc 11 St
G#4	4352	Electro Misc 09 St
A4	4353	Electro Misc 10 St
A#4	6	CF3 Stretch Soft Mn+

More & More

Note	Wave Number	Wave Name
B0	4699	EDM BD 5 Mn
C1	5842	HipHop HH 2 Mn
C#1	4291	EDM Perc St
D1	5472	EDM SD 3 St
D#1	4204	EDM Clap St
E1	4208	House Clap 4 St
F1	6142	EDM Tom Low Mn
F#1	5845	EDM HH 3 Mn
G1	6141	EDM Tom Mid Mn
G#1	5844	EDM HH 2 Mn
A1	6140	EDM Tom High Mn
A#1	5848	EDM OHH 1 Mn
B1	6143	Zap Tom M Mn
C2	6144	Zap Tom M Mn
C#2	5850	EDM OHH 3 St
D2	6145	Zap Tom L Mn
D#2	6336	EDM Ride St
E2	4334	EDM Misc 09 St
F2	4335	EDM Misc 10 St
F#2	5849	EDM OHH 2 St
G2	4337	EDM Misc 12 Mn
G#2	2587	EDM Fx3 St
A2	5471	EDM SD 2 St
A#2	2586	EDM Fx2 St
B2	4326	EDM Misc 01 St
C3	4331	EDM Misc 06 St
C#3	4332	EDM Misc 07 St
D3	4327	EDM Misc 02 St
D#3	4336	EDM Misc 11 St
E3	2585	EDM Fx1 St
F3	4695	EDM BD 1 Mn
F#3	4696	EDM BD 2 St
G3	4698	EDM BD 4 Mn
G#3	4282	Elec Cabasa1 Mn
A3	4283	Elec Cabasa2 Mn
A#3	5475	EDM SD 6 Mn
B3	5474	EDM SD 5 St
C4	4330	EDM Misc 05 St
C#4	4330	EDM Misc 05 St
D4	4333	EDM Misc 08 St
D#4	5473	EDM SD 4 St
E4	4329	EDM Misc 04 St
F4	4328	EDM Misc 03 St
F#4	5846	EDM HH 4 St
G4	5847	EDM HH 5 St
G#4	5843	EDM HH 1 St
A4	5851	EDM OHH 4 St

Magnetism

Note	Wave Number	Wave Name
C0	1	CF3 Stretch Sw St
C1	4450	Bd FK Jazz St

Freaky FM AF1&2

Note	Wave Number	Wave Name
C0	5458	Sd TB Comp2
C#0	5456	Sd TB Q
D0	2531	Abstract Fx1
D#0	2534	Abstract Fx4
E0	2537	Damage Fx1
F0	2536	Bazer Fx
F#0	2539	Damage Fx3
G0	2532	Abstract Fx2
G#0	2563	Electric Fx Perc8
A0	4685	Bd Body2
A#0	5451	Sd ShortDry2
B0	4682	Bd LongBass
C1	4680	Bd EDM10
C#1	5452	Sd ShortGate1
D1	5456	Sd TB Q
D#1	4190	RX11 Clap
E1	5445	Sd Clap1
F1	6138	Comp EleTom Low
F#1	5820	HH TecClosed1
G1	6138	Comp EleTom Low
G#1	5822	HH TecClosed2
A1	6138	Comp EleTom Low
A#1	5823	HH TecOpen2
B1	6137	Comp EleTom High
C2	6137	Comp EleTom High
C#2	6199	PI Crash 15
D2	6137	Comp EleTom High
D#2	6262	Fine Ride Bow
E2	6292	China4
F2	6264	Fine Ride Cup
F#2	3088	Pandeiro1 Tip
G2	6200	PI Crash 16
G#2	2513	Hi Q2
A2	6200	PI Crash 16
A#2	2513	Hi Q2
B2	6263	Fine Ride Edge
C3	2790	Acoustic Bass FX07
C#3	2281	Mini Brip6
D3	2276	Mini Brip1
D#3	2277	Mini Brip2
E3	2967	Quinto1 Slap
F3	3288	Tabla1 Bya
F#3	3272	Djembe1 Edge
G3	3289	Tabla1 Nah
G#3	3545	Barasim Tak
A3	4188	Electric Clap1
A#3	2509	Electric Perc13
B3	2392	Hop FX1
C4	2550	Noize Fx1
C#4	2552	Noize Rize1
D4	2553	Noize Rize2
D#4	2533	Abstract Fx3
E4	2535	Abstract Fx5
F4	4286	Analog Click
F#4	5780	HH Closed T8-1
G4	5431	Sd FM
G#4	5570	HH Half Open2 RL
A4	4276	Claves T8-1
A#4	5781	HH Open T8-1
B4	6346	Reverse Cymbal1
C5	4558	Bd DanceGate1
C#5	4681	Bd EDM Gate
D5	4559	Bd DanceGate2
D#5	2547	Damage Fx11
E5	4662	Bd Stack3
F5	4680	Bd EDM10
F#5	5178	Sd BreakRim
G5	2570	Electric Fx Perc15
G#5	2551	Noize Fx2
A5	2544	Damage Fx8
A#5	2561	Electric Fx Perc6
B5	2559	Electric Fx Perc4
C6	2564	Electric Fx Perc9

Electron

Note	Wave Number	Wave Name
C0	5458	Sd TB Comp2
C#0	5456	Sd TB Q
D0	2531	Abstract Fx1
D#0	2534	Abstract Fx4
E0	2537	Damage Fx1
F0	2536	Bazer Fx
F#0	2539	Damage Fx3
G0	2532	Abstract Fx2
G#0	2563	Electric Fx Perc8
A0	4685	Bd Body2
A#0	5451	Sd ShortDry2
B0	4682	Bd LongBass
C1	4680	Bd EDM10
C#1	5452	Sd ShortGate1
D1	5456	Sd TB Q
D#1	4190	RX11 Clap
E1	5445	Sd Clap1
F1	6138	Comp EleTom Low
F#1	5820	HH TecClosed1
G1	6138	Comp EleTom Low
G#1	5822	HH TecClosed2
A1	6138	Comp EleTom Low
A#1	5823	HH TecOpen2
B1	6137	Comp EleTom High
C2	6137	Comp EleTom High
C#2	6199	PI Crash 15
D2	6137	Comp EleTom High
D#2	6262	Fine Ride Bow
E2	6292	China4
F2	6264	Fine Ride Cup
F#2	3088	Pandeiro1 Tip
G2	6200	PI Crash 16
G#2	2513	Hi Q2
A2	6200	PI Crash 16
A#2	2513	Hi Q2
B2	6263	Fine Ride Edge
C3	2790	Acoustic Bass FX07
C#3	2281	Mini Brip6
D3	2276	Mini Brip1
D#3	2277	Mini Brip2
E3	2967	Quinto1 Slap
F3	3288	Tabla1 Bya
F#3	3272	Djembe1 Edge
G3	3289	Tabla1 Nah
G#3	3545	Barasim Tak
A3	4188	Electric Clap1
A#3	2509	Electric Perc13
B3	2392	Hop FX1
C4	2550	Noize Fx1
C#4	2552	Noize Rize1
D4	2553	Noize Rize2
D#4	2533	Abstract Fx3
E4	2535	Abstract Fx5
F4	4286	Analog Click
F#4	5780	HH Closed T8-1
G4	5431	Sd FM
G#4	5570	HH Half Open2 RL
A4	4276	Claves T8-1
A#4	5781	HH Open T8-1
B4	6346	Reverse Cymbal1
C5	4558	Bd DanceGate1
C#5	4681	Bd EDM Gate
D5	4559	Bd DanceGate2
D#5	2547	Damage Fx11
E5	4662	Bd Stack3
F5	4680	Bd EDM10
F#5	5178	Sd BreakRim
G5	2570	Electric Fx Perc15
G#5	2551	Noize Fx2
A5	2544	Damage Fx8
A#5	2561	Electric Fx Perc6
B5	2559	Electric Fx Perc4
C6	2564	Electric Fx Perc9

Pearly Gates

Note	Wave Number	Wave Name
C0	4683	Bd Body1 Hard
C#0	4684	Bd Body1 Soft
D0	2532	Abstract Fx2
D#0	2536	Bazer Fx
E0	2538	Damage Fx2
F0	2542	Damage Fx6
F#0	2543	Damage Fx7
G0	2534	Abstract Fx4
G#0	2564	Electric Fx Perc9
A0	4679	Bd EDM09
A#0	5458	Sd TB Comp2
B0	4559	Bd DanceGate2
C1	4664	Bd Stack5
C#1	5455	Sd TB Gate
D1	5450	Sd ShortDry1
D#1	4190	RX11 Clap
E1	5446	Sd Clap2
F1	6138	Comp EleTom Low
F#1	5817	HH ClosedNine
G1	6138	Comp EleTom Low
G#1	5818	HH PedalNine
A1	6138	Comp EleTom Low
A#1	5819	HH OpenNine
B1	6137	Comp EleTom High
C2	6137	Comp EleTom High
C#2	6199	PI Crash 15
D2	6137	Comp EleTom High
D#2	6262	Fine Ride Bow
E2	6292	China4
F2	6264	Fine Ride Cup
F#2	3088	Pandeiro1 Tip
G2	6200	PI Crash 16
G#2	2513	Hi Q2
A2	6200	PI Crash 16
A#2	2513	Hi Q2
B2	6263	Fine Ride Edge
C3	2790	Acoustic Bass FX07
C#3	2281	Mini Brip6
D3	2276	Mini Brip1
D#3	2277	Mini Brip2
E3	2967	Quinto1 Slap
F3	3288	Tabla1 Bya
F#3	3272	Djembe1 Edge
G3	3289	Tabla1 Nah
G#3	3545	Barasim Tak
A3	4188	Electric Clap1
A#3	2509	Electric Perc13
B3	2392	Hop FX1
C4	2550	Noize Fx1
C#4	2552	Noize Rize1
D4	2553	Noize Rize2
D#4	2291	Voc Destiny
E4	2440	Epic Fx Loop6
F4	4286	Analog Click
F#4	5780	HH Closed T8-1
G4	5431	Sd FM
G#4	5570	HH Half Open2 RL
A4	4276	Claves T8-1
A#4	5781	HH Open T8-1
B4	6346	Reverse Cymbal1
C5	4653	Bd HrdSpecial
C#5	4654	Bd Hybrid1
D5	4655	Bd Hybrid2
D#5	4656	Bd NewPop1
E5	4657	Bd NewPop2
F5	4658	Bd NewPop3
F#5	5450	Sd ShortDry1
G5	2567	Electric Fx Perc12
G#5	2547	Damage Fx11
A5	2531	Abstract Fx1
A#5	2557	Electric Fx Perc2
B5	2563	Electric Fx Perc8
C6	2570	Electric Fx Perc15

Thursday Evening

Note	Wave Number	Wave Name
C0	4683	Bd Body1 Hard
C#0	4684	Bd Body1 Soft
D0	2532	Abstract Fx2
D#0	2536	Bazer Fx
E0	2538	Damage Fx2
F0	2542	Damage Fx6
F#0	2543	Damage Fx7
G0	2534	Abstract Fx4
G#0	2564	Electric Fx Perc9
A0	4679	Bd EDM09
A#0	5458	Sd TB Comp2
B0	4559	Bd DanceGate2
C1	4674	Bd EDM04
C#1	5455	Sd TB Gate
D1	2552	Noize Rize1
D#1	4190	RX11 Clap
E1	5449	Sd NineComp
F1	6138	Comp EleTom Low
F#1	5817	HH ClosedNine
G1	6138	Comp EleTom Low
G#1	5818	HH PedalNine
A1	6138	Comp EleTom Low
A#1	5819	HH OpenNine
B1	6137	Comp EleTom High
C2	6137	Comp EleTom High
C#2	6199	PI Crash 15
D2	6137	Comp EleTom High
D#2	6262	Fine Ride Bow
E2	6292	China4
F2	6264	Fine Ride Cup
F#2	3088	Pandeiro1 Tip
G2	6200	PI Crash 16
G#2	2513	Hi Q2
A2	6200	PI Crash 16
A#2	2513	Hi Q2
B2	6263	Fine Ride Edge
C3	2790	Acoustic Bass FX07
C#3	2281	Mini Brip6
D3	2276	Mini Brip1
D#3	2277	Mini Brip2
E3	2967	Quinto1 Slap
F3	3288	Tabla1 Bya
F#3	3272	Djembe1 Edge
G3	3289	Tabla1 Nah
G#3	3545	Barasim Tak
A3	4188	Electric Clap1
A#3	2509	Electric Perc13
B3	2392	Hop FX1
C4	2550	Noize Fx1
C#4	2552	Noize Rize1
D4	2553	Noize Rize2
D#4	2533	Abstract Fx3
E4	2535	Abstract Fx5
F4	4286	Analog Click
F#4	5780	HH Closed T8-1
G4	5431	Sd FM
G#4	5570	HH Half Open2 RL
A4	4276	Claves T8-1
A#4	5781	HH Open T8-1
B4	6346	Reverse Cymbal1
C5	4653	Bd HrdSpecial
C#5	4654	Bd Hybrid1
D5	4655	Bd Hybrid2
D#5	4656	Bd NewPop1
E5	4657	Bd NewPop2
F5	4658	Bd NewPop3
F#5	5450	Sd ShortDry1
G5	2567	Electric Fx Perc12
G#5	2534	Abstract Fx4
A5	2531	Abstract Fx1
A#5	2557	Electric Fx Perc2
B5	2563	Electric Fx Perc8
C6	2570	Electric Fx Perc15

Marine Life

Note	Wave Number	Wave Name
C0	2554	Shimmer Fx
C#0	2552	Noize Rize1
D0	2549	HiQ Rize
D#0	2548	Dist Synth Fx
E0	2535	Abstract Fx5
F0	2534	Abstract Fx4
F#0	2533	Abstract Fx3
G0	2532	Abstract Fx2
G#0	2550	Noize Fx1
A0	4558	Bd DanceGate1
A#0	2539	Damage Fx3
B0	2547	Damage Fx11
C1	4664	Bd Stack5
C#1	2545	Damage Fx9
D1	2564	Electric Fx Perc9
D#1	2531	Abstract Fx1
E1	2544	Damage Fx8
F1	2540	Damage Fx4
F#1	5817	HH ClosedNine
G1	2541	Damage Fx5
G#1	5818	HH PedalNine
A1	2537	Damage Fx1
A#1	5819	HH OpenNine
B1	2538	Damage Fx2
C2	2546	Damage Fx10
C#2	6199	PI Crash 15
D2	2545	Damage Fx9
D#2	6262	Fine Ride Bow
E2	6292	China4
F2	6264	Fine Ride Cup
F#2	2556	Electric Fx Perc1
G2	6200	PI Crash 16
G#2	2293	Voc Enjoying This
A2	6200	PI Crash 16
A#2	2558	Electric Fx Perc3
B2	6263	Fine Ride Edge
C3	2559	Electric Fx Perc4
C#3	2560	Electric Fx Perc5
D3	2561	Electric Fx Perc6
D#3	2562	Electric Fx Perc7
E3	2563	Electric Fx Perc8
F3	2564	Electric Fx Perc9
F#3	4251	PC Shaker1
G3	2566	Electric Fx Perc11
G#3	2567	Electric Fx Perc12
A3	2568	Electric Fx Perc13
A#3	2571	Electric Fx Perc16
B3	2569	Electric Fx Perc14
C4	2284	Voc Beat The Band
C#4	2285	Voc Born Happy
D4	2286	Voc Close Eyes
D#4	2287	Voc Complication
E4	2288	Voc Day Life
F4	2289	Voc DeepWater
F#4	2290	Voc Desperation
G4	2291	Voc Destiny
G#4	2295	Voc Forbidden Dreams
A4	2293	Voc Enjoying This
A#4	2294	Voc Feel Good
B4	2295	Voc Forbidden Dreams
C5	2296	Voc Freezing Cold
C#5	2297	Voc Infinity
D5	2298	Voc Love Is Blind
D#5	2299	Voc Mystery
E5	2300	Voc Reality
F5	2303	Voc Yesterday
F#5	2301	Voc Revolution
G5	2302	Voc Sweeping
G#5	2523	Granular Loop1
A5	2524	Granular Loop2
A#5	2526	Granular Loop4
B5	2527	Granular Loop5
C6	2438	Epic Fx Loop4

Wave Surfer

Note	Wave Number	Wave Name
C0	2554	Shimmer Fx
C#0	2552	Noize Rize1
D0	2549	HiQ Rize
D#0	2548	Dist Synth Fx
E0	2535	Abstract Fx5
F0	2534	Abstract Fx4
F#0	2533	Abstract Fx3
G0	2532	Abstract Fx2
G#0	2550	Noize Fx1
A0	4558	Bd DanceGate1
A#0	2539	Damage Fx3
B0	2547	Damage Fx11
C1	4698	EDM BD 4 Mn
C#1	2545	Damage Fx9
D1	5512	HipHop SD 2 Mn
D#1	2531	Abstract Fx1
E1	5512	HipHop SD 2 Mn
F1	2540	Damage Fx4
F#1	5822	HH TecClosed2
G1	2538	Damage Fx2
G#1	5821	HH TecOpen1
A1	2537	Damage Fx1
A#1	5823	HH TecOpen2
B1	2538	Damage Fx2
C2	2546	Damage Fx10
C#2	6199	PI Crash 15
D2	2545	Damage Fx9
D#2	6262	Fine Ride Bow
E2	6292	China4
F2	6264	Fine Ride Cup
F#2	2556	Electric Fx Perc1
G2	6200	PI Crash 16
G#2	2557	Electric Fx Perc2
A2	6200	PI Crash 16
A#2	2558	Electric Fx Perc3
B2	6263	Fine Ride Edge
C3	2559	Electric Fx Perc4
C#3	2560	Electric Fx Perc5
D3	2561	Electric Fx Perc6
D#3	2562	Electric Fx Perc7
E3	2563	Electric Fx Perc8
F3	2564	Electric Fx Perc9
F#3	4251	PC Shaker1
G3	2566	Electric Fx Perc11
G#3	2567	Electric Fx Perc12
A3	2568	Electric Fx Perc13
A#3	2571	Electric Fx Perc16
B3	2569	Electric Fx Perc14
C4	2284	Voc Beat The Band
C#4	2285	Voc Born Happy
D4	2286	Voc Close Eyes
D#4	2287	Voc Complication
E4	2288	Voc Day Life
F4	2289	Voc DeepWater
F#4	2290	Voc Desperation
G4	2291	Voc Destiny
G#4	2292	Voc Dreamin Of U
A4	2293	Voc Enjoying This
A#4	2294	Voc Feel Good
B4	2295	Voc Forbidden Dreams
C5	2296	Voc Freezing Cold
C#5	2297	Voc Infinity
D5	2298	Voc Love Is Blind
D#5	2299	Voc Mystery
E5	2300	Voc Reality
F5	2303	Voc Yesterday
F#5	2301	Voc Revolution
G5	2302	Voc Sweeping
G#5	2523	Granular Loop1
A5	2524	Granular Loop2
A#5	2526	Granular Loop4
B5	2527	Granular Loop5
C6	2438	Epic Fx Loop4

Run It

Note	Wave Number	Wave Name
B0	4688	Dub BD 2 St
C1	4694	Trap BD 2 Mn
C#1	4291	EDM Perc St
D1	5468	Trap SD 5 St
D#1	5511	HipHop SD 1 St
E1	4198	Trap Clap 3 St
F1	5340	Electric Snare
F#1	5829	Trap HH 2 St
G1	4362	T8 Sub-1 M
G#1	5828	Trap HH 1 St
A1	4363	T8 Sub-2 M
A#1	5837	Trap OHH 1 St
B1	4364	T8 Sub-3 M
C2	4365	T8 Sub-4 M
C#2	5839	Trap OHH 3 St
D2	4366	T8 Sub-5 M
D#2	5788	T8 HHO 3
E2	5838	Trap OHH 2 St
F2	4323	Trap Misc 9 St
F#2	6314	Trap Crash 2 St
G2	4199	Trap Clap 4 Mn
G#2	4200	Trap Clap 5 Mn
A2	5831	Trap HH 4 St
A#2	5833	Trap HH 6 St
B2	5835	Trap HH 8 St
C3	5836	Trap HH 9 St
C#3	4320	Trap Misc 6 St
D3	4318	Trap Misc 4 St
D#3	4317	Trap Misc 3 St
E3	4197	Trap Clap 2 Mn
F3	4198	Trap Clap 3 St
F#3	4322	Trap Misc 8 St
G3	4316	Trap Misc 2 St
G#3	4315	Trap Misc 1 St
A3	4319	Trap Misc 5 St
A#3	5830	Trap HH 3 St
B3	5834	Trap HH 7 St
C4	2576	Trap Fx1 St
C#4	2579	Trap Fx4 St
D4	2577	Trap Fx2 St
D#4	5467	Trap SD 4 Mn
E4	5466	Trap SD 3 Mn
F4	5464	Trap SD 1 St
F#4	4290	Trap Perc 2 St
G4	2580	Trap Fx5 St
G#4	2578	Trap Fx3 St
A4	2581	Trap Fx6 St

Under Dirt

Note	Wave Number	Wave Name
A#0	4721	HipHop BD 1 St
B0	4722	HipHop BD 2 Mn
C1	4724	HipHop BD 4 Mn
C#1	2857	HipHop Stick1 Mn
D1	5512	HipHop SD 2 Mn
D#1	4202	HipHop Clap 1 St
E1	5511	HipHop SD 1 St
F1	6152	House Tom Lo L Mn
F#1	5842	HipHop HH 2 Mn
G1	6151	House Tom Lo H Mn
G#1	5841	HipHop HH 1 Mn
A1	6150	House Tom Mid L Mn
A#1	5865	Opeh HH 14inch
B1	6149	House Tom Mid M Mn
C2	6148	House Tom Mid H Mn
C#2	6316	HipHop Crash 2 St
D2	6147	House Tom Hi L Mn
D#2	6344	HipHop Ride St
E2	6315	HipHop Crash 1 St
F2	6344	HipHop Ride St
F#2	2853	HipHop Tamb2 Mn
G2	2584	HipHop Fx3 St
G#2	3230	HipHop Cowbell 1 Mn
A2	6317	HipHop Crash 3 St
A#2	5514	HipHop Rim St
B2	6337	House Ride St
C3	3010	HipHop Bongo1 Mn
C#3	3011	HipHop Bongo2 Mn
D3	4725	HipHop BD 5 Mn
D#3	4723	HipHop BD 3 Mn
E3	4691	Dub BD 5 St
F3	4203	HipHop Clap 2 St
F#3	4210	Electro Clap 2 St
G3	5480	House SD 5 St
G#3	5477	House SD 2 Mn
A3	2835	HipHop Shaker1 Mn
A#3	2836	HipHop Shaker2 Mn
B3	4287	HipHop Flex1
C4	4288	HipHop Flex2
C#4	3117	House Guiro Mn
D4	3116	HipHop Guiro Mn
D#4	4298	HipHop Clunk St
E4	2873	HipHop WB1 Mn
F4	2874	HipHop WB2 Mn
F#4	2652	HipHop Scratch1 St
G4	2653	HipHop Scratch2 St
G#4	4281	House Triangle Mn
A4	4280	HipHop Triangle Mn

Rock Ready

Note	Wave Number	Wave Name
C0	4286	Analog Click
C#0	5224	Sd Brush Soft St
D0	5236	Sd Brush Swir St
D#0	5227	Sd Brush Med St
E0	5239	Sd Brush SwirAtt St
F0	5206	Sd RockRoll St
F#0	2860	Castanet1
G0	4947	Sd Rock Open2 St
G#0	2855	Stick1
A0	4440	Bd Room3
A#0	4944	Sd Rock Rim1 St
B0	4430	Bd Rock2 St
C1	4620	Fresh BD St
C#1	5182	Sd Rock Stick1 St
D1	5475	EDM SD 6 Mn
D#1	4213	HipHop Clap3
E1	4941	Sd Rock Mute1 St
F1	5899	Tom Rock Low St
F#1	5575	HH Closed Rock Sw St
G1	5899	Tom Rock Low St
G#1	5587	HH Pedal Rock Sw St
A1	5895	Tom Rock Mid St
A#1	5599	HH Open Rock Sw St
B1	5895	Tom Rock Mid St
C2	5891	Tom Rock Hi St
C#2	6174	Crash1 RL
D2	5891	Tom Rock Hi St
D#2	6229	Ride2 St
E2	6283	China1 St
F2	6276	Ride Cup2 St
F#2	4258	Tambourine RX5
G2	6293	Splash1 St
G#2	3223	Cowbell1
A2	6171	Crash1 St
A#2	2879	Vibraslap1
B2	6232	Ride2 RL
C3	2979	Bongo1 Hi 1Fingr 1-2
C#3	2992	Bongo1 Lo 3Fingr 1-2
D3	2922	Conga1 Hi Tip
D#3	2926	Conga1 Hi Open 2
E3	2970	Tumba Open
F3	3026	Timbale1 Hi 1-3
F#3	3030	Timbale1 Lo 1-2
G3	3105	Agogo1 Hi
G#3	3106	Agogo1 Lo
A3	3062	Cabasa1A 1-2
A#3	3059	Maracas1 Slur
B3	3220	Whistle
C4	3220	Whistle
C#4	3113	Guiro1 Short
D4	3112	Guiro1 Long
D#4	3217	Claves1
E4	2872	Wood Block
F4	2872	Wood Block
F#4	2975	Cuica1 Hi
G4	2974	Cuica1 Lo
G#4	2884	Triangle1 Mute
A4	2883	Triangle1 Open
A#4	2817	ShakerA 1
B4	2908	Sleigh Bell1
C5	2912	Wind Chime 1
C#5	4956	Sd Rock Flam St
D5	4947	Sd Rock Open2 St
D#5	4953	Sd Rock Rim2 St
E5	4950	Sd Rock Mute2 St
F5	4404	Bd Funk 1St
F#5	5209	Sd RockRollD St
G5	4418	Bd H Son St
G#5	4909	Sd Tight St1-4
A5	4424	Bd Funk Son St
A#5	4867	Sd SonA 3St
B5	4407	Bd Funk R1-2
C6	4418	Bd H Son St

PowerStandardKit 1

Note	Wave Number	Wave Name
C0	3217	Claves1
C#0	5224	Sd Brush Soft St
D0	5236	Sd Brush Swir St
D#0	5227	Sd Brush Med St
E0	5239	Sd Brush SwirAtt St
F0	5212	Sd LiveRoll St
F#0	2860	Castanet1
G0	5037	Sd PowerD 1St
G#0	2855	Stick1
A0	4463	Bd PowerB 1-2St
A#0	5049	Sd PowerD 5St
B0	4454	Bd PowerA 1-2St
C1	4441	Bd Jazz1-2St
C#1	5007	Sd PowerB SSt
D1	5010	Sd PowerC 1-5St
D#1	2889	Hand Clap1 St
E1	5031	Sd PowerD 1-5St
F1	5939	Tom Power04 1-2St
F#1	5614	HH Power ClTip 1-4St
G1	5939	Tom Power04 1-2St
G#1	5654	HH Power ClPedal St
A1	5927	Tom Power03 1-2St
A#1	5658	HH Power Open EdgeSt
B1	5915	Tom Power02 1-2St
C2	5915	Tom Power02 1-2St
C#2	6175	Crash2 St
D2	5903	Tom Power01 1-2St
D#2	6225	Ride1 St
E2	6283	China1 St
F2	6253	Ride Cup1 St
F#2	2843	Tambourine1 Sw
G2	6293	Splash1 St
G#2	3224	Cowbell2
A2	6178	Crash2 RL
A#2	2879	Vibraslap1
B2	6229	Ride2 St
C3	2979	Bongo1 Hi 1Fingr 1-2
C#3	2989	Bongo1 Lo 1Fingr 1-2
D3	2930	Conga1 Hi SlpMute1-2
D#3	2924	Conga1 Hi Open 1-2
E3	2935	Conga1 Lo Open 1-2
F3	3026	Timbale1 Hi 1-3
F#3	3030	Timbale1 Lo 1-2
G3	3105	Agogo1 Hi
G#3	3106	Agogo1 Lo
A3	3062	Cabasa1A 1-2
A#3	3059	Maracas1 Slur
B3	3220	Whistle
C4	3220	Whistle
C#4	3113	Guiro1 Short
D4	3112	Guiro1 Long
D#4	3217	Claves1
E4	2872	Wood Block
F4	2872	Wood Block
F#4	2975	Cuica1 Hi
G4	2974	Cuica1 Lo
G#4	2884	Triangle1 Mute
A4	2883	Triangle1 Open
A#4	2816	ShakerA 13
B4	2908	Sleigh Bell1
C5	2912	Wind Chime 1
C#5	4726	Sd Bld St1-4
D5	4885	Sd Blues 3St
D#5	4929	Sd Hip St1-2
E5	4826	Sd Funk St1-3
F5	4746	Sd Soul St1-4
F#5	5177	Sd LdwHMMono
G5	5180	Sd Heavy
G#5	4909	Sd Tight St1-4
A5	4894	Sd BluesHeart St1-3
A#5	4367	Bd Snap 1-2
B5	4376	Bd Tight 1-2
C6	4403	Bd Funk St1-2

PowerStandardKit 2

Note	Wave Number	Wave Name
C0	3217	Claves1
C#0	5224	Sd Brush Soft St
D0	5236	Sd Brush Swir St
D#0	5227	Sd Brush Med St
E0	5239	Sd Brush SwirAtt St
F0	5212	Sd LiveRoll St
F#0	2860	Castanet1
G0	4971	Sd PowerA 1St
G#0	2855	Stick1
A0	4463	Bd PowerB 1-2St
A#0	4983	Sd PowerA 5St
B0	4454	Bd PowerA 1-2St
C1	4441	Bd Jazz1-2St
C#1	5007	Sd PowerB SSt
D1	4986	Sd PowerB 1-5St
D#1	2889	Hand Clap1 St
E1	4965	Sd PowerA 1-5St
F1	5939	Tom Power04 1-2St
F#1	5634	HH Power ClEdge1-4St
G1	5939	Tom Power04 1-2St
G#1	5654	HH Power ClPedal St
A1	5927	Tom Power03 1-2St
A#1	5658	HH Power Open EdgeSt
B1	5915	Tom Power02 1-2St
C2	5915	Tom Power02 1-2St
C#2	6175	Crash2 St
D2	5903	Tom Power01 1-2St
D#2	6225	Ride1 St
E2	6283	China1 St
F2	6253	Ride Cup1 St
F#2	2843	Tambourine1 Sw
G2	6293	Splash1 St
G#2	3224	Cowbell2
A2	6178	Crash2 RL
A#2	2879	Vibraslap1
B2	6229	Ride2 St
C3	2979	Bongo1 Hi 1Fingr 1-2
C#3	2989	Bongo1 Lo 1Fingr 1-2
D3	2930	Conga1 Hi SlpMute1-2
D#3	2924	Conga1 Hi Open 1-2
E3	2935	Conga1 Lo Open 1-2
F3	3026	Timbale1 Hi 1-3
F#3	3030	Timbale1 Lo 1-2
G3	3105	Agogo1 Hi
G#3	3106	Agogo1 Lo
A3	3062	Cabasa1A 1-2
A#3	3059	Maracas1 Slur
B3	3220	Whistle
C4	3220	Whistle
C#4	3113	Guiro1 Short
D4	3112	Guiro1 Long
D#4	3217	Claves1
E4	2872	Wood Block
F4	2872	Wood Block
F#4	2975	Cuica1 Hi
G4	2974	Cuica1 Lo
G#4	2884	Triangle1 Mute
A4	2883	Triangle1 Open
A#4	2816	ShakerA 13
B4	2908	Sleigh Bell1
C5	2912	Wind Chime 1
C#5	4726	Sd Bld St1-4
D5	4885	Sd Blues 3St
D#5	4929	Sd Hip St1-2
E5	4826	Sd Funk St1-3
F5	4746	Sd Soul St1-4
F#5	5177	Sd LdwHMMono
G5	5180	Sd Heavy
G#5	4909	Sd Tight St1-4
A5	4894	Sd BluesHeart St1-3
A#5	4367	Bd Snap 1-2
B5	4376	Bd Tight 1-2
C6	4403	Bd Funk St1-2

Hyper Standard Kit

Note	Wave Number	Wave Name
C0	3217	Claves1
C#0	5224	Sd Brush Soft St
D0	5236	Sd Brush Swir St
D#0	5227	Sd Brush Med St
E0	5239	Sd Brush SwirAtt St
F0	5212	Sd LiveRoll St
F#0	2860	Castanet1
G0	4812	Sd Normal 1St
G#0	2855	Stick1
A0	4424	Bd Funk Son St
A#0	4844	Sd Basic St1-3
B0	4368	Bd Snap 1
C1	4418	Bd H Son St
C#1	5198	Sd Closed Rim St
D1	4859	Sd SonA St1-4
D#1	4179	Clap T9-1
E1	4909	Sd Tight St1-4
F1	5887	Tom Floor St
F#1	5563	HH Closed Foot St
G1	5887	Tom Floor St
G#1	5567	HH Half Open2 St
A1	5883	Tom Low St
A#1	5571	HH Open2 St
B1	5883	Tom Low St
C2	5879	Tom Mid St
C#2	6178	Crash2 RL
D2	5875	Tom Hi St
D#2	6225	Ride1 St
E2	6283	China1 St
F2	6253	Ride Cup1 St
F#2	2843	Tambourine1 Sw
G2	6293	Splash1 St
G#2	3224	Cowbell2
A2	6178	Crash2 RL
A#2	2879	Vibraslap1
B2	6228	Ride1 RL
C3	2979	Bongo1 Hi 1Fingr 1-2
C#3	2992	Bongo1 Lo 3Fingr 1-2
D3	2922	Conga1 Hi Tip
D#3	2926	Conga1 Hi Open 2
E3	2970	Tumba Open
F3	3026	Timbale1 Hi 1-3
F#3	3030	Timbale1 Lo 1-2
G3	3105	Agogo1 Hi
G#3	3106	Agogo1 Lo
A3	3062	Cabasa1A 1-2
A#3	3059	Maracas1 Slur
B3	3220	Whistle
C4	3220	Whistle
C#4	3113	Guiro1 Short
D4	3112	Guiro1 Long
D#4	3217	Claves1
E4	2872	Wood Block
F4	2872	Wood Block
F#4	2975	Cuica1 Hi
G4	2974	Cuica1 Lo
G#4	2884	Triangle1 Mute
A4	2883	Triangle1 Open
A#4	2817	ShakerA 1
B4	2908	Sleigh Bell1
C5	2912	Wind Chime 1
C#5	4726	Sd Bld St1-4
D5	4879	Sd Blues St1-3
D#5	4902	Sd BluesHeart R1-3
E5	4929	Sd Hip St1-2
F5	4806	Sd Normal St1-4
F#5	5177	Sd LdwHMMono
G5	4747	Sd Soul St1-3
G#5	5180	Sd Heavy
A5	4830	Sd Funk 1St
A#5	4395	Bd Normal 1St
B5	4424	Bd Funk Son St
C6	4367	Bd Snap 1-2

Dry Standard Kit

Note	Wave Number	Wave Name
C0	3217	Claves1
C#0	5224	Sd Brush Soft St
D0	5236	Sd Brush Swir St
D#0	5227	Sd Brush Med St
E0	5239	Sd Brush SwirAtt St
F0	5212	Sd LiveRoll St
F#0	2860	Castanet1
G0	4812	Sd Normal 1St
G#0	2855	Stick1
A0	4403	Bd Funk St1-2
A#0	4846	Sd Basic St2-3
B0	4412	Bd High St
C1	4394	Bd Normal St1-2
C#1	5198	Sd Closed Rim St
D1	4806	Sd Normal St1-4
D#1	4179	Clap T9-1
E1	4845	Sd Basic St1-2
F1	5887	Tom Floor St
F#1	5515	HH Closed 1-4St
G1	5887	Tom Floor St
G#1	5538	HH Pedal 3 St
A1	5883	Tom Low St
A#1	5551	HH Open 1-2St
B1	5883	Tom Low St
C2	5879	Tom Mid St
C#2	6178	Crash2 RL
D2	5875	Tom Hi St
D#2	6225	Ride1 St
E2	6283	China1 St
F2	6253	Ride Cup1 St
F#2	2843	Tambourine1 Sw
G2	6293	Splash1 St
G#2	3224	Cowbell2
A2	6178	Crash2 RL
A#2	2879	Vibraslap1
B2	6228	Ride2 RL
C3	2979	Bongo1 Hi 1Fingr 1-2
C#3	2992	Bongo1 Lo 3Fingr 1-2
D3	2928	Conga1 Hi Slap Open
D#3	2926	Conga1 Hi Open 2
E3	2970	Tumba Open
F3	3026	Timbale1 Hi 1-3
F#3	3030	Timbale1 Lo 1-2
G3	3105	Agogo1 Hi
G#3	3106	Agogo1 Lo
A3	3062	Cabasa1A 1-2
A#3	3059	Maracas1 Slur
B3	3220	Whistle
C4	3220	Whistle
C#4	3113	Guiro1 Short
D4	3112	Guiro1 Long
D#4	3217	Claves1
E4	2872	Wood Block
F4	2872	Wood Block
F#4	2975	Cuica1 Hi
G4	2974	Cuica1 Lo
G#4	2884	Triangle1 Mute
A4	2883	Triangle1 Open
A#4	2817	ShakerA 1
B4	2908	Sleigh Bell1
C5	2912	Wind Chime 1
C#5	4726	Sd Bld St1-4
D5	4886	Sd Blues L1-3
D#5	4929	Sd Hip St1-2
E5	4826	Sd Funk St1-3
F5	4748	Sd Soul St2-4
F#5	5177	Sd LdwHMono
G5	5180	Sd Heavy
G#5	4909	Sd Tight St1-4
A5	4897	Sd BluesHeart St13
A#5	4367	Bd Snap 1-2
B5	4376	Bd Tight 1-2
C6	4403	Bd Funk St1-2

Modern Rock Kit

Note	Wave Number	Wave Name
C0	3217	Claves1
C#0	5224	Sd Brush Soft St
D0	5236	Sd Brush Swir St
D#0	5227	Sd Brush Med St
E0	5239	Sd Brush SwirAtt St
F0	5212	Sd LiveRoll St
F#0	2860	Castanet1
G0	4940	Sd Rock Open1 R
G#0	2855	Stick1
A0	4438	Bd Room1
A#0	4795	Sd Rng St4
B0	4447	Bd Jazz2St
C1	4440	Bd Room3
C#1	5185	Sd Rock Stick2 St
D1	4766	Sd Strong St1-4
D#1	4216	HipHop Clap6
E1	4965	Sd PowerA 1-5St
F1	5887	Tom Floor St
F#1	5575	HH Closed Rock Sw St
G1	5883	Tom Low St
G#1	5603	HH Half Open Rock St
A1	5883	Tom Low St
A#1	5601	HH Open Rock St
B1	5879	Tom Mid St
C2	5879	Tom Mid St
C#2	6174	Crash1 RL
D2	5875	Tom Hi St
D#2	6229	Ride2 St
E2	6283	China1 St
F2	6276	Ride Cup2 St
F#2	2843	Tambourine1 Sw
G2	6293	Splash1 St
G#2	3224	Cowbell2
A2	6171	Crash1 St
A#2	2879	Vibraslap1
B2	6256	Ride Cup1 RL
C3	2979	Bongo1 Hi 1Fingr 1-2
C#3	2992	Bongo1 Lo 3Fingr 1-2
D3	2922	Conga1 Hi Tip
D#3	2926	Conga1 Hi Open 2
E3	2970	Tumba Open
F3	3026	Timbale1 Hi 1-3
F#3	3030	Timbale1 Lo 1-2
G3	3105	Agogo1 Hi
G#3	3106	Agogo1 Lo
A3	3062	Cabasa1A 1-2
A#3	3059	Maracas1 Slur
B3	3220	Whistle
C4	3220	Whistle
C#4	3113	Guiro1 Short
D4	3112	Guiro1 Long
D#4	3217	Claves1
E4	2872	Wood Block
F4	2872	Wood Block
F#4	2975	Cuica1 Hi
G4	2974	Cuica1 Lo
G#4	2884	Triangle1 Mute
A4	2883	Triangle1 Open
A#4	2817	ShakerA 1
B4	2908	Sleigh Bell1
C5	2912	Wind Chime 1
C#5	4882	Sd Blues St13
D5	4909	Sd Tight St1-4
D#5	4902	Sd BluesHeart R1-3
E5	4920	Sd Tight R1-4
F5	4415	Bd Low St
F#5	5025	Sd PowerC 4St
G5	4602	Bd R&B1
G#5	4986	Sd PowerB 1-5St
A5	4438	Bd Room1
A#5	4965	Sd PowerA 1-5St
B5	4424	Bd Funk Son St
C6	4439	Bd Room2

Rock Stereo Kit 1

Note	Wave Number	Wave Name
C0	4286	Analog Click
C#0	5224	Sd Brush Soft St
D0	5236	Sd Brush Swir St
D#0	5227	Sd Brush Med St
E0	5239	Sd Brush SwirAtt St
F0	5206	Sd RockRoll St
F#0	2860	Castanet1
G0	4947	Sd Rock Open2 St
G#0	2855	Stick1
A0	4440	Bd Room3
A#0	4944	Sd Rock Rim1 St
B0	4430	Bd Rock2 St
C1	4427	Bd Rock1 St
C#1	5182	Sd Rock Stick1 St
D1	4938	Sd Rock Open1 St
D#1	4213	HipHop Clap3
E1	4941	Sd Rock Mute1 St
F1	5899	Tom Rock Low St
F#1	5575	HH Closed Rock Sw St
G1	5899	Tom Rock Low St
G#1	5587	HH Pedal Rock Sw St
A1	5895	Tom Rock Mid St
A#1	5599	HH Open Rock Sw St
B1	5895	Tom Rock Mid St
C2	5891	Tom Rock Hi St
C#2	6174	Crash1 RL
D2	5891	Tom Rock Hi St
D#2	6229	Ride2 St
E2	6283	China1 St
F2	6276	Ride Cup2 St
F#2	4258	Tambourine RX5
G2	6293	Splash1 St
G#2	3223	Cowbell1
A2	6171	Crash1 St
A#2	2879	Vibraslap1
B2	6232	Ride2 RL
C3	2979	Bongo1 Hi 1Fingr 1-2
C#3	2992	Bongo1 Lo 3Fingr 1-2
D3	2922	Conga1 Hi Tip
D#3	2926	Conga1 Hi Open 2
E3	2970	Tumba Open
F3	3026	Timbale1 Hi 1-3
F#3	3030	Timbale1 Lo 1-2
G3	3105	Agogo1 Hi
G#3	3106	Agogo1 Lo
A3	3062	Cabasa1A 1-2
A#3	3059	Maracas1 Slur
B3	3220	Whistle
C4	3220	Whistle
C#4	3113	Guiro1 Short
D4	3112	Guiro1 Long
D#4	3217	Claves1
E4	2872	Wood Block
F4	2872	Wood Block
F#4	2975	Cuica1 Hi
G4	2974	Cuica1 Lo
G#4	2884	Triangle1 Mute
A4	2883	Triangle1 Open
A#4	2817	ShakerA 1
B4	2908	Sleigh Bell1
C5	2912	Wind Chime 1
C#5	4956	Sd Rock Flam St
D5	4947	Sd Rock Open2 St
D#5	4953	Sd Rock Rim2 St
E5	4950	Sd Rock Mute2 St
F5	4404	Bd Funk 1St
F#5	5209	Sd RockRollID St
G5	4418	Bd H Son St
G#5	4909	Sd Tight St1-4
A5	4424	Bd Funk Son St
A#5	4867	Sd SonA 3St
B5	4407	Bd Funk R1-2
C6	4418	Bd H Son St

Rock Stereo Kit 2

Note	Wave Number	Wave Name
C0	4286	Analog Click
C#0	5224	Sd Brush Soft St
D0	5236	Sd Brush Swir St
D#0	5227	Sd Brush Med St
E0	5239	Sd Brush SwirAtt St
F0	5206	Sd RockRoll St
F#0	2860	Castanet1
G0	4947	Sd Rock Open2 St
G#0	2855	Stick1
A0	4438	Bd Room1
A#0	4953	Sd Rock Rim2 St
B0	4388	Bd Ambience L1-2
C1	4430	Bd Rock2 St
C#1	5185	Sd Rock Stick2 St
D1	4947	Sd Rock Open2 St
D#1	2889	Hand Clap1 St
E1	4950	Sd Rock Mute2 St
F1	5899	Tom Rock Low St
F#1	5591	HH Closed Rock 2St
G1	5899	Tom Rock Low St
G#1	5603	HH Half Open Rock St
A1	5895	Tom Rock Mid St
A#1	5601	HH Open Rock St
B1	5895	Tom Rock Mid St
C2	5891	Tom Rock Hi St
C#2	6175	Crash2 St
D2	5891	Tom Rock Hi St
D#2	6229	Ride2 St
E2	6283	China1 St
F2	6276	Ride Cup2 St
F#2	4258	Tambourine RX5
G2	6293	Splash1 St
G#2	3223	Cowbell1
A2	6178	Crash2 RL
A#2	2879	Vibraslap1
B2	6232	Ride2 RL
C3	2979	Bongo1 Hi 1Fingr 1-2
C#3	2992	Bongo1 Lo 3Fingr 1-2
D3	2922	Conga1 Hi Tip
D#3	2926	Conga1 Hi Open 2
E3	2970	Tumba Open
F3	3026	Timbale1 Hi 1-3
F#3	3030	Timbale1 Lo 1-2
G3	3105	Agogo1 Hi
G#3	3106	Agogo1 Lo
A3	3062	Cabasa1A 1-2
A#3	3059	Maracas1 Slur
B3	3220	Whistle
C4	3220	Whistle
C#4	3113	Guiro1 Short
D4	3112	Guiro1 Long
D#4	3217	Claves1
E4	2872	Wood Block
F4	2872	Wood Block
F#4	2975	Cuica1 Hi
G4	2974	Cuica1 Lo
G#4	2884	Triangle1 Mute
A4	2883	Triangle1 Open
A#4	2817	ShakerA 1
B4	2908	Sleigh Bell1
C5	2912	Wind Chime 1
C#5	4956	Sd Rock Flam St
D5	4938	Sd Rock Open1 St
D#5	4944	Sd Rock Rim1 St
E5	4941	Sd Rock Mute1 St
F5	4427	Bd Rock1 St
F#5	5209	Sd RockRollID St
G5	4405	Bd Funk 2St
G#5	4909	Sd Tight St1-4
A5	4412	Bd High St
A#5	4868	Sd SonA 4St
B5	4421	Bd L Son St
C6	4427	Bd Rock1 St

Nu Hip Hop Kit 1

Note	Wave Number	Wave Name
C0	4709	Bd HipHop2
C#0	3064	Cabasa1A 2
D0	5495	Sd HipHop7
D#0	2635	Scratch Lo R
E0	2640	Scratch Vo F
F0	5209	Sd RockRollD St
F#0	3217	Claves1
G0	5492	Sd HipHop4
G#0	5507	Sd HipHop Rim3
A0	4715	Bd HipHop8
A#0	5510	Sd HipHop Rim6
B0	4716	Bd HipHop9
C1	4712	Bd HipHop5
C#1	5506	Sd HipHop Rim2
D1	5497	Sd HipHop9
D#1	4212	HipHop Clap2
E1	5490	Sd HipHop2
F1	5888	Tom Floor L
F#1	5807	HH Closed Hip
G1	5884	Tom Low L
G#1	5808	HH Pedal Hip
A1	5881	Tom Mid R
A#1	5809	HH Open Hip
B1	5877	Tom Hi R
C2	5877	Tom Hi R
C#2	6180	Crash4
D2	5877	Tom Hi R
D#2	6230	Ride2 L
E2	6176	Crash2 L
F2	6280	Ride Mono
F#2	2845	Tambourine1 Hit
G2	6220	Hand Cymbal Open L
G#2	3236	Mambo Bell Body
A2	6285	China1 R
A#2	2906	Handbell L
B2	6282	Ride Cup Mono2
C3	2928	Conga1 Hi Slap Open
C#3	2936	Conga1 Lo Open 1
D3	2933	Conga1 Lo Tip
D#3	2939	Conga1 Lo Slap Open
E3	2937	Conga1 Lo Open 2
F3	4711	Bd HipHop4
F#3	4213	HipHop Clap3
G3	3105	Agogo1 Hi
G#3	3106	Agogo1 Lo
A3	2818	ShakerA 2
A#3	2817	ShakerA 1
B3	4717	Bd HipHop10
C4	4713	Bd HipHop6
C#4	5508	Sd HipHop Rim4
D4	5493	Sd HipHop5
D#4	4229	HipHop Snap1
E4	4717	Bd HipHop10
F4	5494	Sd HipHop6
F#4	4211	HipHop Clap1
G4	3051	Paila L
G#4	2884	Triangle1 Mute
A4	2883	Triangle1 Open
A#4	2843	Tambourine1 Sw
B4	2818	ShakerA 2
C5	4715	Bd HipHop8
C#5	4179	Clap T9-1
D5	5376	Sd T8-1
D#5	5376	Sd T8-1
E5	5379	Sd T8-4
F5	6123	Tom T8
F#5	5782	HH Closed T8-2
G5	6123	Tom T8
G#5	5782	HH Closed T8-2
A5	6123	Tom T8
A#5	5783	HH Open T8-2
B5	6123	Tom T8
C6	6305	Crash T8-1

Nu Hip Hop Kit 2

Note	Wave Number	Wave Name
C0	4710	Bd HipHop3
C#0	2513	Hi Q2
D0	2645	Scratch Hip2
D#0	2639	Scratch Sd R
E0	2641	Scratch Vo R
F0	5421	Sd Break Roll
F#0	5355	Sd T9Rim
G0	5490	Sd HipHop2
G#0	5381	Sd T8 Rim
A0	4716	Bd HipHop9
A#0	5505	Sd HipHop Rim1
B0	4713	Bd HipHop6
C1	4712	Bd HipHop5
C#1	5506	Sd HipHop Rim2
D1	5489	Sd HipHop1
D#1	4216	HipHop Clap6
E1	5495	Sd HipHop7
F1	6107	Tom T9 Lo
F#1	5807	HH Closed Hip
G1	6107	Tom T9 Lo
G#1	5808	HH Pedal Hip
A1	6106	Tom T9 Hi
A#1	5809	HH Open Hip
B1	6106	Tom T9 Hi
C2	6123	Tom T8
C#2	6179	Crash3
D2	6123	Tom T8
D#2	6329	Ride T9-1
E2	6329	Ride T9-1
F2	6210	Crash Brush Cup St
F#2	4258	Tambourine RX5
G2	6310	Crash Syn
G#2	4248	Cowbell AnCR
A2	6303	Crash T9-1
A#2	3121	MetalGuero Long
B2	6280	Ride Mono
C3	3151	Cajon1 Tip 1-2
C#3	2996	Bongo1 Lo Tip
D3	3103	Tmbourim Finger
D#3	3079	Tumbo 2
E3	2973	Tumba Heel
F3	3052	Paila H
F#3	3051	Paila L
G3	4242	Cowbell T8
G#3	4248	Cowbell AnCR
A3	3441	Shekere Up
A#3	3074	Caxixi 1
B3	2469	Grain2 St
C4	2470	Grain2 L
C#4	3152	Cajon1 Tip 1
D4	4217	HipHop Clap7
D#4	3217	Claves1
E4	2872	Wood Block
F4	5508	Sd HipHop Rim4
F#4	4229	HipHop Snap1
G4	4230	HipHop Snap2
G#4	4279	Electric Triangle
A4	2883	Triangle1 Open
A#4	2817	ShakerA 1
B4	3121	MetalGuero Long
C5	2912	Wind Chime 1
C#5	5508	Sd HipHop Rim4
D5	5376	Sd T8-1
D#5	5377	Sd T8-2
E5	5379	Sd T8-4
F5	6123	Tom T8
F#5	5782	HH Closed T8-2
G5	6123	Tom T8
G#5	5782	HH Closed T8-2
A5	6123	Tom T8
A#5	5783	HH Open T8-2
B5	6123	Tom T8
C6	4287	HipHop Flex1

Hip Hop Kit 1

Note	Wave Number	Wave Name
C0	5189	Sd Hip Stick2
C#0	2514	Vox Hit Rev
D0	2616	TurnTable
D#0	2376	Hit Brass
E0	2639	Scratch Sd R
F0	5214	Sd LiveRoll R
F#0	4276	Claves T8-1
G0	4937	Sd Hip 2R
G#0	5195	Sd Hip Stick6 R
A0	4716	Bd HipHop9
A#0	5430	Sd Garg L
B0	4582	Bd T8-3
C1	4560	Bd T9-1
C#1	5507	Sd HipHop Rim3
D1	5496	Sd HipHop8
D#1	4216	HipHop Clap6
E1	5489	Sd HipHop1
F1	6123	Tom T8
F#1	5780	HH Closed T8-1
G1	6123	Tom T8
G#1	5781	HH Open T8-1
A1	6123	Tom T8
A#1	5781	HH Open T8-1
B1	6123	Tom T8
C2	6123	Tom T8
C#2	6180	Crash4
D2	6123	Tom T8
D#2	6267	Ride Brush1 R
E2	6305	Crash T8-1
F2	6329	Ride T9-1
F#2	4258	Tambourine RX5
G2	6295	Splash1 R
G#2	3236	Mambo Bell Body
A2	6303	Crash T9-1
A#2	2879	Vibraslap1
B2	6329	Ride T9-1
C3	2979	Bongo1 Hi 1Fingr 1-2
C#3	2992	Bongo1 Lo 3Fingr 1-2
D3	2922	Conga1 Hi Tip
D#3	2926	Conga1 Hi Open 2
E3	2970	Tumba Open
F3	3026	Timbale1 Hi 1-3
F#3	3030	Timbale1 Lo 1-2
G3	3105	Agogo1 Hi
G#3	3106	Agogo1 Lo
A3	3062	Cabasa1A 1-2
A#3	3059	Maracas1 Slur
B3	3220	Whistle
C4	3220	Whistle
C#4	3113	Guero1 Short
D4	3112	Guero1 Long
D#4	3217	Claves1
E4	2872	Wood Block
F4	2872	Wood Block
F#4	2975	Cuica1 Hi
G4	2974	Cuica1 Lo
G#4	2884	Triangle1 Mute
A4	2883	Triangle1 Open
A#4	2817	ShakerA 1
B4	2908	Sleigh Bell1
C5	2912	Wind Chime 1
C#5	5197	Sd Hip Stick8
D5	5399	Sd Jungle3
D#5	2891	Hand Clap1 R
E5	5416	Sd Hip Rim5
F5	2629	Scratch H
F#5	2630	Scratch L
G5	2631	Scratch Down
G#5	2633	Scratch Hi R
A5	2636	Scratch Bd F
A#5	2648	Scratch Combi
B5	2641	Scratch Vo R
C6	4607	Bd Break2

Hip Hop Kit 2

Note	Wave Number	Wave Name
C0	4582	Bd T8-3
C#0	5381	Sd T8 Rim
D0	5408	Sd Hip1
D#0	4179	Clap T9-1
E0	5433	Sd Syn
F0	5214	Sd LiveRoll R
F#0	5191	Sd Hip Stick4
G0	5490	Sd HipHop2
G#0	5510	Sd HipHop Rim6
A0	4604	Bd Hip Deep
A#0	5406	Sd R&B1 Rim
B0	4608	Bd Break Heavy
C1	4604	Bd Hip Deep
C#1	5506	Sd HipHop Rim2
D1	5410	Sd Hip3
D#1	2889	Hand Clap1 St
E1	5438	Sd Lo-Fi
F1	5889	Tom Floor R
F#1	5810	HH Closed Lo-Fi
G1	5884	Tom Low L
G#1	5799	HH Closed Break
A1	5884	Tom Low L
A#1	5811	HH Open Lo-Fi
B1	5884	Tom Low L
C2	5876	Tom Hi L
C#2	6179	Crash3
D2	5876	Tom Hi L
D#2	6329	Ride T9-1
E2	6287	China2
F2	6281	Ride Cup Mono
F#2	4258	Tambourine RX5
G2	6179	Crash3
G#2	4247	Cowbell RX11
A2	6177	Crash2 R
A#2	4242	Cowbell T8
B2	6329	Ride T9-1
C3	2979	Bongo1 Hi 1Fingr 1-2
C#3	2992	Bongo1 Lo 3Fingr 1-2
D3	2922	Conga1 Hi Tip
D#3	2928	Conga1 Hi Slap Open
E3	2926	Conga1 Hi Open 2
F3	2445	Radio Noise
F#3	2445	Radio Noise
G3	3106	Agogo1 Lo
G#3	3106	Agogo1 Lo
A3	3063	Cabasa1A 1
A#3	4272	MaracasT8-1
B3	2613	FxGun2
C4	2612	FxGun1
C#4	2643	Scratch Spin
D4	2642	Scratch Stop
D#4	4276	Claves T8-1
E4	2618	Door Squeak
F4	2513	Hi Q2
F#4	2636	Scratch Bd F
G4	2637	Scratch Bd R
G#4	2884	Triangle1 Mute
A4	2883	Triangle1 Open
A#4	4250	Analog Shaker
B4	2845	Tambourine1 Hit
C5	2912	Wind Chime 1
C#5	5396	Sd Human2
D5	5421	Sd Break Roll
D#5	2379	Stab Hard
E5	5397	Sd Jungle1
F5	4427	Bd Rock1 St
F#5	2631	Scratch Down
G5	3483	Wa Taiko
G#5	2374	HH Hit
A5	2380	Stab Organ2
A#5	2332	Sonar1
B5	2616	TurnTable
C6	2617	Police

Hip Hop Kit 3

Note	Wave Number	Wave Name
C0	5381	Sd T8 Rim
C#0	2514	Vox Hit Rev
D0	2616	TurnTable
D#0	2379	Stab Hard
E0	2641	Scratch Vo R
F0	5215	Sd Roll Mono
F#0	4276	Claves T8-1
G0	4935	Sd Hip 1R
G#0	5191	Sd Hip Stick4
A0	4591	Bd AnCR
A#0	5414	Sd Hip Rim3
B0	4562	Bd T9-3
C1	4604	Bd Hip Deep
C#1	5192	Sd Hip Stick5
D1	5411	Sd Hip Gate
D#1	4216	HipHop Clap6
E1	5438	Sd Lo-Fi
F1	6123	Tom T8
F#1	5807	HH Closed Hip
G1	6123	Tom T8
G#1	5808	HH Pedal Hip
A1	6123	Tom T8
A#1	5809	HH Open Hip
B1	6123	Tom T8
C2	6123	Tom T8
C#2	6180	Crash4
D2	6123	Tom T8
D#2	6231	Ride2 R
E2	6305	Crash T8-1
F2	6329	Ride T9-1
F#2	4258	Tambourine RX5
G2	6295	Splash1 R
G#2	3236	Mambo Bell Body
A2	6303	Crash T9-1
A#2	2879	Vibraslap1
B2	6329	Ride T9-1
C3	2979	Bongo1 Hi 1Fingr 1-2
C#3	2992	Bongo1 Lo 3Fingr 1-2
D3	2922	Conga1 Hi Tip
D#3	2928	Conga1 Hi Slap Open
E3	2926	Conga1 Hi Open 2
F3	3026	Timbale1 Hi 1-3
F#3	3030	Timbale1 Lo 1-2
G3	3105	Agogo1 Hi
G#3	3106	Agogo1 Lo
A3	2825	Shaker Hip1
A#3	3059	Maracas1 Slur
B3	3220	Whistle
C4	3220	Whistle
C#4	3113	Guiro1 Short
D4	3112	Guiro1 Long
D#4	3217	Claves1
E4	2872	Wood Block
F4	2872	Wood Block
F#4	2975	Cuica1 Hi
G4	2974	Cuica1 Lo
G#4	2884	Triangle1 Mute
A4	2883	Triangle1 Open
A#4	2817	ShakerA 1
B4	2908	Sleigh Bell1
C5	2912	Wind Chime 1
C#5	5188	Sd Hip Stick1
D5	5397	Sd Jungle1
D#5	2891	Hand Clap1 R
E5	5420	Sd Break Heavy
F5	2630	Scratch L
F#5	2631	Scratch Down
G5	2632	Scratch Hi F
G#5	2634	Scratch Lo F
A5	2635	Scratch Lo R
A#5	2636	Scratch Bd F
B5	2637	Scratch Bd R
C6	4608	Bd Break Heavy

Hip Hop Kit 4

Note	Wave Number	Wave Name
C0	5188	Sd Hip Stick1
C#0	2512	Hi Q1
D0	2616	TurnTable
D#0	2382	Hit Uhh
E0	2642	Scratch Stop
F0	5213	Sd LiveRoll L
F#0	4276	Claves T8-1
G0	5428	Sd Cut
G#0	5184	Sd Rock Stick1 R
A0	4561	Bd T9-2
A#0	5412	Sd Hip Rim1
B0	4603	Bd R&B2
C1	4605	Bd Break Deep
C#1	5202	Sd Closed Rim3
D1	5413	Sd Hip Rim2
D#1	4214	HipHop Clap4
E1	5405	Sd R&B1
F1	4231	Conga T8
F#1	5780	HH Closed T8-1
G1	4231	Conga T8
G#1	5782	HH Closed T8-2
A1	4231	Conga T8
A#1	5783	HH Open T8-2
B1	4231	Conga T8
C2	4231	Conga T8
C#2	6180	Crash4
D2	4231	Conga T8
D#2	6231	Ride2 R
E2	6305	Crash T8-1
F2	6329	Ride T9-1
F#2	4258	Tambourine RX5
G2	6295	Splash1 R
G#2	3236	Mambo Bell Body
A2	6303	Crash T9-1
A#2	2879	Vibraslap1
B2	6329	Ride T9-1
C3	2979	Bongo1 Hi 1Fingr 1-2
C#3	2992	Bongo1 Lo 3Fingr 1-2
D3	2922	Conga1 Hi Tip
D#3	2926	Conga1 Hi Open 2
E3	2970	Tumba Open
F3	3026	Timbale1 Hi 1-3
F#3	3030	Timbale1 Lo 1-2
G3	3105	Agogo1 Hi
G#3	3106	Agogo1 Lo
A3	3062	Cabasa1A 1-2
A#3	3059	Maracas1 Slur
B3	3220	Whistle
C4	3220	Whistle
C#4	3113	Guiro1 Short
D4	3112	Guiro1 Long
D#4	3217	Claves1
E4	2872	Wood Block
F4	2872	Wood Block
F#4	2975	Cuica1 Hi
G4	2974	Cuica1 Lo
G#4	2884	Triangle1 Mute
A4	2883	Triangle1 Open
A#4	2817	ShakerA 1
B4	2908	Sleigh Bell1
C5	2912	Wind Chime 1
C#5	5200	Sd Closed Rim R
D5	5392	Sd AnSm Rim
D#5	2889	Hand Clap1 St
E5	5410	Sd Hip3
F5	2639	Scratch Sd R
F#5	2644	Scratch Hip
G5	2637	Scratch Bd R
G#5	2641	Scratch Vo R
A5	2645	Scratch Hip2
A#5	2649	Scratch Combi2
B5	2651	Scratch Combi4
C6	4604	Bd Hip Deep

Hip Stick Kit 1

Note	Wave Number	Wave Name
C0	5415	Sd Hip Rim4
C#0	2512	Hi Q1
D0	2616	TurnTable
D#0	2375	Hit Orchestra1
E0	2637	Scratch Bd R
F0	5214	Sd LiveRoll R
F#0	4286	Analog Click
G0	5414	Sd Hip Rim3
G#0	5394	Sd AnCR Rim
A0	4716	Bd HipHop9
A#0	5510	Sd HipHop Rim6
B0	4582	Bd T8-3
C1	4581	Bd T8-2
C#1	5381	Sd T8 Rim
D1	5191	Sd Hip Stick4
D#1	2891	Hand Clap1 R
E1	5190	Sd Hip Stick3
F1	6123	Tom T8
F#1	5780	HH Closed T8-1
G1	6123	Tom T8
G#1	5781	HH Open T8-1
A1	6123	Tom T8
A#1	5781	HH Open T8-1
B1	6123	Tom T8
C2	6123	Tom T8
C#2	6180	Crash4
D2	6123	Tom T8
D#2	6231	Ride2 R
E2	6305	Crash T8-1
F2	6329	Ride T9-1
F#2	4258	Tambourine RX5
G2	6295	Splash1 R
G#2	3236	Mambo Bell Body
A2	6303	Crash T9-1
A#2	2879	Vibraslap1
B2	6329	Ride T9-1
C3	2979	Bongo1 Hi 1Fingr 1-2
C#3	2992	Bongo1 Lo 3Fingr 1-2
D3	2922	Conga1 Hi Tip
D#3	2926	Conga1 Hi Open 2
E3	2970	Tumba Open
F3	3026	Timbale1 Hi 1-3
F#3	3030	Timbale1 Lo 1-2
G3	3105	Agogo1 Hi
G#3	3106	Agogo1 Lo
A3	3062	Cabasa1A 1-2
A#3	3059	Maracas1 Slur
B3	3220	Whistle
C4	3220	Whistle
C#4	3113	Guiro1 Short
D4	3112	Guiro1 Long
D#4	3217	Claves1
E4	2872	Wood Block
F4	2872	Wood Block
F#4	2975	Cuica1 Hi
G4	2974	Cuica1 Lo
G#4	2884	Triangle1 Mute
A4	2883	Triangle1 Open
A#4	2817	ShakerA 1
B4	2908	Sleigh Bell1
C5	2912	Wind Chime 1
C#5	5391	Sd AnSm
D5	5202	Sd Closed Rim3
D#5	4286	Analog Click
E5	5201	Sd Closed Rim2
F5	2629	Scratch H
F#5	2630	Scratch L
G5	2631	Scratch Down
G#5	2633	Scratch Hi R
A5	2636	Scratch Bd F
A#5	2648	Scratch Combi
B5	2641	Scratch Vo R
C6	4598	Bd Jungle2

Hip Stick Kit 2

Note	Wave Number	Wave Name
C0	5414	Sd Hip Rim3
C#0	2513	Hi Q2
D0	2629	Scratch H
D#0	2629	Scratch H
E0	2641	Scratch Vo R
F0	5215	Sd Roll Mono
F#0	4286	Analog Click
G0	5415	Sd Hip Rim4
G#0	5381	Sd T8 Rim
A0	4716	Bd HipHop9
A#0	5191	Sd Hip Stick4
B0	4631	Bd Hard Long
C1	4647	Bd ElecClick
C#1	5188	Sd Hip Stick1
D1	5189	Sd Hip Stick2
D#1	4218	HipHop Clap8
E1	5193	Sd Hip Stick6 St
F1	6107	Tom T9 Lo
F#1	5780	HH Closed T8-1
G1	6107	Tom T9 Lo
G#1	5781	HH Open T8-1
A1	6107	Tom T9 Lo
A#1	5781	HH Open T8-1
B1	6107	Tom T9 Lo
C2	6107	Tom T9 Lo
C#2	6303	Crash T9-1
D2	6107	Tom T9 Lo
D#2	6228	Ride1 RL
E2	6305	Crash T8-1
F2	6282	Ride Cup Mono2
F#2	4261	Electric Tambourine2
G2	6295	Splash1 R
G#2	4242	Cowbell T8
A2	6303	Crash T9-1
A#2	2879	Vibraslap1
B2	6310	Crash Syn
C3	2979	Bongo1 Hi 1Fingr 1-2
C#3	2992	Bongo1 Lo 3Fingr 1-2
D3	2922	Conga1 Hi Tip
D#3	2926	Conga1 Hi Open 2
E3	2970	Tumba Open
F3	3026	Timbale1 Hi 1-3
F#3	3030	Timbale1 Lo 1-2
G3	3105	Agogo1 Hi
G#3	3106	Agogo1 Lo
A3	3062	Cabasa1A 1-2
A#3	3059	Maracas1 Slur
B3	3220	Whistle
C4	3220	Whistle
C#4	3113	Guiro1 Short
D4	3112	Guiro1 Long
D#4	3217	Claves1
E4	2872	Wood Block
F4	2872	Wood Block
F#4	2975	Cuica1 Hi
G4	2974	Cuica1 Lo
G#4	2884	Triangle1 Mute
A4	2883	Triangle1 Open
A#4	2817	ShakerA 1
B4	2908	Sleigh Bell1
C5	2912	Wind Chime 1
C#5	5381	Sd T8 Rim
D5	5188	Sd Hip Stick1
D#5	5189	Sd Hip Stick2
E5	5201	Sd Closed Rim2
F5	2631	Scratch Down
F#5	2632	Scratch Hi F
G5	2634	Scratch Lo F
G#5	2635	Scratch Lo R
A5	2637	Scratch Bd R
A#5	2648	Scratch Combi
B5	2642	Scratch Stop
C6	4715	Bd HipHop8

R&B Kit 1

Note	Wave Number	Wave Name
C0	4566	Bd T9 Hd3
C#0	5393	Sd AnCR
D0	5392	Sd AnSm Rim
D#0	5426	Sd Clap Analog
E0	5354	Sd T9Gate
F0	5215	Sd Roll Mono
F#0	5435	Sd Timbr
G0	5432	Sd FM Rim
G#0	5400	Sd JungleFX
A0	4563	Bd T9-4
A#0	5416	Sd Hip Rim5
B0	4562	Bd T9-3
C1	4638	Bd Elec2
C#1	5381	Sd T8 Rim
D1	5438	Sd Lo-Fi
D#1	4212	HipHop Clap2
E1	5405	Sd R&B1
F1	4582	Bd T8-3
F#1	5766	HH Closed T9
G1	4582	Bd T8-3
G#1	5808	HH Pedal Hip
A1	4582	Bd T8-3
A#1	5767	HH Open T9
B1	4582	Bd T8-3
C2	4582	Bd T8-3
C#2	6174	Crash1 RL
D2	4582	Bd T8-3
D#2	6229	Ride2 St
E2	6287	China2
F2	6281	Ride Cup Mono
F#2	2845	Tambourine1 Hit
G2	6179	Crash3
G#2	3223	Cowbell1
A2	6171	Crash1 St
A#2	4242	Cowbell T8
B2	6225	Ride1 St
C3	2979	Bongo1 Hi 1Fingr 1-2
C#3	2992	Bongo1 Lo 3Fingr 1-2
D3	2922	Conga1 Hi Tip
D#3	2928	Conga1 Hi Slap Open
E3	2926	Conga1 Hi Open 2
F3	2512	Hi Q1
F#3	2512	Hi Q1
G3	3106	Agogo1 Lo
G#3	3106	Agogo1 Lo
A3	4250	Analog Shaker
A#3	3059	Maracas1 Slur
B3	2384	Vox Drum
C4	2384	Vox Drum
C#4	2512	Hi Q1
D4	2513	Hi Q2
D#4	4276	Claves T8-1
E4	2512	Hi Q1
F4	2643	Scratch Spin
F#4	2633	Scratch Hi R
G4	2632	Scratch Hi F
G#4	2884	Triangle1 Mute
A4	2883	Triangle1 Open
A#4	2818	ShakerA 2
B4	2845	Tambourine1 Hit
C5	2912	Wind Chime 1
C#5	5421	Sd Break Roll
D5	2494	Noise Burst
D#5	2317	Vox Bell
E5	5405	Sd R&B1
F5	2323	VoxAlk
F#5	3525	Udu High
G5	2321	Trance Choir
G#5	2615	Swarm
A5	4435	Bd Pop
A#5	5406	Sd R&B1 Rim
B5	4603	Bd R&B2
C6	6179	Crash3

R&B Kit 2

Note	Wave Number	Wave Name
C0	4560	Bd T9-1
C#0	5394	Sd AnCR Rim
D0	5411	Sd Hip Gate
D#0	5421	Sd Break Roll
E0	5350	Sd T9-2
F0	5212	Sd LiveRoll St
F#0	4230	HipHop Snap2
G0	5495	Sd HipHop7
G#0	5506	Sd HipHop Rim2
A0	4712	Bd HipHop5
A#0	5415	Sd Hip Rim4
B0	4560	Bd T9-1
C1	4581	Bd T8-2
C#1	5505	Sd HipHop Rim1
D1	4230	HipHop Snap2
D#1	4218	HipHop Clap8
E1	5380	Sd T8-5
F1	6123	Tom T8
F#1	5780	HH Closed T8-1
G1	6123	Tom T8
G#1	5781	HH Open T8-1
A1	6123	Tom T8
A#1	5781	HH Open T8-1
B1	6123	Tom T8
C2	6123	Tom T8
C#2	6174	Crash1 RL
D2	6123	Tom T8
D#2	6229	Ride2 St
E2	6287	China2
F2	6281	Ride Cup Mono
F#2	2845	Tambourine1 Hit
G2	6179	Crash3
G#2	3223	Cowbell1
A2	6171	Crash1 St
A#2	4242	Cowbell T8
B2	6225	Ride1 St
C3	2979	Bongo1 Hi 1Fingr 1-2
C#3	2992	Bongo1 Lo 3Fingr 1-2
D3	2922	Conga1 Hi Tip
D#3	2928	Conga1 Hi Slap Open
E3	2926	Conga1 Hi Open 2
F3	2512	Hi Q1
F#3	2512	Hi Q1
G3	3106	Agogo1 Lo
G#3	3106	Agogo1 Lo
A3	4250	Analog Shaker
A#3	3059	Maracas1 Slur
B3	2384	Vox Drum
C4	2384	Vox Drum
C#4	2512	Hi Q1
D4	2513	Hi Q2
D#4	4276	Claves T8-1
E4	2512	Hi Q1
F4	2643	Scratch Spin
F#4	2633	Scratch Hi R
G4	2632	Scratch Hi F
G#4	2884	Triangle1 Mute
A4	2883	Triangle1 Open
A#4	2818	ShakerA 2
B4	2845	Tambourine1 Hit
C5	2912	Wind Chime 1
C#5	5421	Sd Break Roll
D5	2494	Noise Burst
D#5	2317	Vox Bell
E5	5405	Sd R&B1
F5	2323	VoxAlk
F#5	3525	Udu High
G5	2321	Trance Choir
G#5	2615	Swarm
A5	4435	Bd Pop
A#5	5406	Sd R&B1 Rim
B5	4603	Bd R&B2
C6	6179	Crash3

R&B Kit 3

Note	Wave Number	Wave Name
C0	4565	Bd T9 Hd2
C#0	5393	Sd AnCR
D0	5418	Sd Break2
D#0	5421	Sd Break Roll
E0	5354	Sd T9Gate
F0	5215	Sd Roll Mono
F#0	4230	HipHop Snap2
G0	5490	Sd HipHop2
G#0	5507	Sd HipHop Rim3
A0	4561	Bd T9-2
A#0	5414	Sd Hip Rim3
B0	4560	Bd T9-1
C1	4581	Bd T8-2
C#1	5507	Sd HipHop Rim3
D1	5405	Sd R&B1
D#1	4216	HipHop Clap6
E1	5411	Sd Hip Gate
F1	6107	Tom T9 Lo
F#1	5766	HH Closed T9
G1	6107	Tom T9 Lo
G#1	5767	HH Open T9
A1	6107	Tom T9 Lo
A#1	5767	HH Open T9
B1	6107	Tom T9 Lo
C2	6106	Tom T9 Hi
C#2	6174	Crash1 RL
D2	4582	Bd T8-3
D#2	6229	Ride2 St
E2	6287	China2
F2	6281	Ride Cup Mono
F#2	2845	Tambourine1 Hit
G2	6179	Crash3
G#2	3223	Cowbell1
A2	6171	Crash1 St
A#2	4242	Cowbell T8
B2	6225	Ride1 St
C3	2979	Bongo1 Hi 1Fingr 1-2
C#3	2992	Bongo1 Lo 3Fingr 1-2
D3	2922	Conga1 Hi Tip
D#3	2928	Conga1 Hi Slap Open
E3	2926	Conga1 Hi Open 2
F3	2512	Hi Q1
F#3	2512	Hi Q1
G3	3106	Agogo1 Lo
G#3	3106	Agogo1 Lo
A3	4250	Analog Shaker
A#3	3059	Maracas1 Slur
B3	2384	Vox Drum
C4	2384	Vox Drum
C#4	2512	Hi Q1
D4	2513	Hi Q2
D#4	4276	Claves T8-1
E4	2512	Hi Q1
F4	2643	Scratch Spin
F#4	2633	Scratch Hi R
G4	2632	Scratch Hi F
G#4	2884	Triangle1 Mute
A4	2883	Triangle1 Open
A#4	2818	ShakerA 2
B4	2845	Tambourine1 Hit
C5	2912	Wind Chime 1
C#5	5421	Sd Break Roll
D5	2494	Noise Burst
D#5	2317	Vox Bell
E5	5405	Sd R&B1
F5	2323	VoxAlk
F#5	3525	Udu High
G5	2321	Trance Choir
G#5	2615	Swarm
A5	4435	Bd Pop
A#5	5406	Sd R&B1 Rim
B5	4603	Bd R&B2
C6	6179	Crash3

Trance Kit

Note	Wave Number	Wave Name
C0	4561	Bd T9-2
C#0	5392	Sd AnSm Rim
D0	5324	Sd Elec9
D#0	4187	Clap AnSm
E0	5322	Sd Elec7
F0	5326	Sd Elec11
F#0	5322	Sd Elec7
G0	5376	Sd T8-1
G#0	5353	Sd T9-5
A0	4565	Bd T9 Hd2
A#0	5327	Sd Elec12
B0	4566	Bd T9 Hd3
C1	4631	Bd Hard Long
C#1	5355	Sd T9Rim
D1	5320	Sd Elec5
D#1	4179	Clap T9-1
E1	5350	Sd T9-2
F1	5433	Sd Syn
F#1	5766	HH Closed T9
G1	5433	Sd Syn
G#1	5767	HH Open T9
A1	5433	Sd Syn
A#1	5767	HH Open T9
B1	5433	Sd Syn
C2	5433	Sd Syn
C#2	6303	Crash T9-1
D2	5433	Sd Syn
D#2	6329	Ride T9-1
E2	6310	Crash Syn
F2	6281	Ride Cup Mono
F#2	2845	Tambourine1 Hit
G2	6305	Crash T8-1
G#2	4242	Cowbell T8
A2	6283	China1 St
A#2	4242	Cowbell T8
B2	6225	Ride1 St
C3	2979	Bongo1 Hi 1Fingr 1-2
C#3	2992	Bongo1 Lo 3Fingr 1-2
D3	2929	Conga1 Hi Slap
D#3	2928	Conga1 Hi Slap Open
E3	2926	Conga1 Hi Open 2
F3	6131	Tom Syn1
F#3	6131	Tom Syn1
G3	4286	Analog Click
G#3	2494	Noise Burst
A3	3064	Cabasa1A 2
A#3	3059	Maracas1 Slur
B3	2397	Neo Seq Em-3
C4	2413	Neo Seq2 Em-5
C#4	2497	Electric Perc1
D4	2825	Shaker Hip1
D#4	4276	Claves T8-1
E4	4258	Tambourine RX5
F4	4247	Cowbell RX11
F#4	2826	Shaker Hip2
G4	2506	Electric Perc10
G#4	2884	Triangle1 Mute
A4	2883	Triangle1 Open
A#4	2828	Shaker Hip4
B4	2496	Zap2
C5	4715	Bd HipHop8
C#5	4564	Bd T9 Hd1
D5	4643	Bd ElecComp3
D#5	4560	Bd T9-1
E5	4566	Bd T9 Hd3
F5	4631	Bd Hard Long
F#5	5780	HH Closed T8-1
G5	4642	Bd ElecComp2
G#5	5783	HH Open T8-2
A5	4564	Bd T9 Hd1
A#5	5781	HH Open T8-1
B5	4565	Bd T9 Hd2
C6	4643	Bd ElecComp3

Psychedelic Kit

Note	Wave Number	Wave Name
C0	2446	LFO Seq
C#0	2321	Trance Choir
D0	3431	Tibetan Bowl
D#0	2642	Scratch Stop
E0	2465	Fx Female Voice St
F0	2380	Stab Organ2
F#0	2618	Door Squeak
G0	2445	Radio Noise
G#0	2618	Door Squeak
A0	2789	Acoustic Bass FX06
A#0	2794	Electric Bass FX 02
B0	2789	Acoustic Bass FX06
C1	4596	Bd BlpHd
C#1	4595	Bd Brip
D1	5411	Sd Hip Gate
D#1	4859	Sd SonA St1-4
E1	2494	Noise Burst
F1	6135	Tom Dist Lo
F#1	5766	HH Closed T9
G1	6134	Tom Dist Hi
G#1	5517	HH Closed 2St
A1	6106	Tom T9 Hi
A#1	5767	HH Open T9
B1	6106	Tom T9 Hi
C2	6106	Tom T9 Hi
C#2	6283	China1 St
D2	6106	Tom T9 Hi
D#2	6293	Splash1 St
E2	6303	Crash T9-1
F2	6329	Ride T9-1
F#2	3088	Pandeiro1 Tip
G2	4260	Electric Tambourine1
G#2	2513	Hi Q2
A2	4556	Bd Gate
A#2	2513	Hi Q2
B2	2786	Acoustic Bass FX03
C3	2784	Acoustic Bass FX01
C#3	2281	Mini Brip6
D3	2276	Mini Brip1
D#3	2277	Mini Brip2
E3	2967	Quinto1 Slap
F3	3288	Tabla1 Bya
F#3	3272	Djembe1 Edge
G3	3289	Tabla1 Nah
G#3	3545	Barasim Tak
A3	2504	Electric Perc8
A#3	2509	Electric Perc13
B3	2392	Hop FX1
C4	2341	Motion Beam
C#4	2496	Zap2
D4	2480	Digi Voice Mod
D#4	1909	Human Whistle
E4	2479	Digital Wind
F4	4286	Analog Click
F#4	5780	HH Closed T8-1
G4	5431	Sd FM
G#4	5570	HH Half Open2 RL
A4	4276	Claves T8-1
A#4	5781	HH Open T8-1
B4	6346	Reverse Cymbal1
C5	4632	Bd Analog Tight
C#5	4643	Bd ElecComp3
D5	4566	Bd T9 Hd3
D#5	4627	Bd ZapHard
E5	4636	Bd Slimy
F5	4609	Bd Break Hard
F#5	5178	Sd BreakRim
G5	4747	Sd Soul St1-3
G#5	4964	Sd Ambience
A5	4943	Sd Rock Mute1 R
A#5	5428	Sd Cut
B5	5403	Sd D&B3
C6	5422	Sd FX1

Chill Out Kit

Note	Wave Number	Wave Name
C0	4580	Bd T8-1
C#0	5381	Sd T8 Rim
D0	5377	Sd T8-2
D#0	4188	Electric Clap1
E0	5326	Sd Elec11
F0	5322	Sd Elec7
F#0	5379	Sd T8-4
G0	4638	Bd Elec2
G#0	5376	Sd T8-1
A0	4715	Bd HipHop8
A#0	5378	Sd T8-3
B0	4716	Bd HipHop9
C1	4715	Bd HipHop8
C#1	5392	Sd AnSm Rim
D1	5492	Sd HipHop4
D#1	4187	Clap AnSm
E1	5493	Sd HipHop5
F1	6123	Tom T8
F#1	5780	HH Closed T8-1
G1	6123	Tom T8
G#1	5781	HH Open T8-1
A1	6123	Tom T8
A#1	5781	HH Open T8-1
B1	6123	Tom T8
C2	6123	Tom T8
C#2	6179	Crash3
D2	6123	Tom T8
D#2	6329	Ride T9-1
E2	6293	Splash1 St
F2	6281	Ride Cup Mono
F#2	2845	Tambourine1 Hit
G2	6305	Crash T8-1
G#2	4242	Cowbell T8
A2	6283	China1 St
A#2	4242	Cowbell T8
B2	6225	Ride1 St
C3	4231	Conga T8
C#3	4231	Conga T8
D3	4231	Conga T8
D#3	4231	Conga T8
E3	4231	Conga T8
F3	2929	Conga1 Hi Slap
F#3	2928	Conga1 Hi Slap Open
G3	2926	Conga1 Hi Open 2
G#3	3027	Timbale1 Hi 1
A3	3064	Cabasa1A 2
A#3	3059	Maracas1 Slur
B3	2465	Fx Female Voice St
C4	2417	Portamento Lead Seq
C#4	2505	Electric Perc9
D4	2825	Shaker Hip1
D#4	4276	Claves T8-1
E4	2512	Hi Q1
F4	2513	Hi Q2
F#4	2826	Shaker Hip2
G4	2511	Electric Perc15
G#4	2884	Triangle1 Mute
A4	2883	Triangle1 Open
A#4	2828	Shaker Hip4
B4	2489	Ripper
C5	4640	Bd Elec4
C#5	5408	Sd Hip1
D5	5324	Sd Elec9
D#5	5321	Sd Elec6
E5	5490	Sd HipHop2
F5	4646	Bd ElecGate
F#5	5782	HH Closed T8-2
G5	4635	Bd ThickSkin
G#5	5783	HH Open T8-2
A5	4608	Bd Break Heavy
A#5	5783	HH Open T8-2
B5	4605	Bd Break Deep
C6	4603	Bd R&B2

Brush Kit

Note	Wave Number	Wave Name
C0	3217	Claves1
C#0	5224	Sd Brush Soft St
D0	5236	Sd Brush Swir St
D#0	5227	Sd Brush Med St
E0	5239	Sd Brush SwirAtt St
F0	5212	Sd LiveRoll St
F#0	2860	Castanet1
G0	5224	Sd Brush Soft St
G#0	2855	Stick1
A0	4403	Bd Funk St1-2
A#0	4850	Sd Basic 3St
B0	4441	Bd Jazz1-2St
C1	4450	Bd FK Jazz St
C#1	5233	Sd Closed Rim4 St
D1	5227	Sd Brush Med St
D#1	2889	Hand Clap1 St
E1	5230	Sd Brush vari St
F1	6082	Tom Brush Floor St
F#1	5614	HH Power CiTip 1-4St
G1	6078	Tom Brush Low St
G#1	5654	HH Power CiPedal St
A1	6078	Tom Brush Low St
A#1	5658	HH Power Open EdgeSt
B1	6074	Tom Brush Mid St
C2	6074	Tom Brush Mid St
C#2	6206	Crash Brush1 St
D2	6070	Tom Brush Hi St
D#2	6265	Ride Brush1 St
E2	6283	China1 St
F2	6210	Crash Brush Cup St
F#2	2843	Tambourine1 Sw
G2	6293	Splash1 St
G#2	3224	Cowbell2
A2	6214	Crash Brush2 St
A#2	2879	Vibraslap1
B2	6269	Ride Brush2 St
C3	2979	Bongo1 Hi 1Fingr 1-2
C#3	2989	Bongo1 Lo 1Fingr 1-2
D3	2930	Conga1 Hi SlpMute1-2
D#3	2924	Conga1 Hi Open 1-2
E3	2935	Conga1 Lo Open 1-2
F3	3026	Timbale1 Hi 1-3
F#3	3030	Timbale1 Lo 1-2
G3	3105	Agogo1 Hi
G#3	3106	Agogo1 Lo
A3	3062	Cabasa1A 1-2
A#3	3059	Maracas1 Slur
B3	3220	Whistle
C4	3220	Whistle
C#4	3113	Guiro1 Short
D4	3112	Guiro1 Long
D#4	3217	Claves1
E4	2872	Wood Block
F4	2872	Wood Block
F#4	2975	Cuica1 Hi
G4	2974	Cuica1 Lo
G#4	2884	Triangle1 Mute
A4	2883	Triangle1 Open
A#4	2816	ShakerA 13
B4	2908	Sleigh Bell1
C5	2912	Wind Chime 1
C#5	4726	Sd Bld St1-4
D5	4885	Sd Blues 3St
D#5	4929	Sd Hip St1-2
E5	4826	Sd Funk St1-3
F5	4746	Sd Soul St1-4
F#5	5177	Sd LdwHMono
G5	5180	Sd Heavy
G#5	4909	Sd Tight St1-4
A5	4894	Sd BluesHeart.St1-3
A#5	4367	Bd Snap 1-2
B5	4376	Bd Tight 1-2
C6	4403	Bd Funk St1-2

Jazz Kit

Note	Wave Number	Wave Name
C0	4441	Bd Jazz1-2St
C#0	5226	Sd Brush Soft R
D0	5239	Sd Brush SwirAtt St
D#0	5227	Sd Brush Med St
E0	5239	Sd Brush SwirAtt St
F0	5212	Sd LiveRoll St
F#0	2860	Castanet1
G0	4930	Sd Hip 1St
G#0	2855	Stick1
A0	4408	Bd Funk 1 L
A#0	4917	Sd Tight 3St
B0	4450	Bd FK Jazz St
C1	4403	Bd Funk St1-2
C#1	5198	Sd Closed Rim St
D1	4915	Sd Tight 1St
D#1	5206	Sd RockRoll St
E1	4894	Sd BluesHeart St1-3
F1	5887	Tom Floor St
F#1	5614	HH Power CiTip 1-4St
G1	5887	Tom Floor St
G#1	5654	HH Power CiPedal St
A1	5883	Tom Low St
A#1	5658	HH Power Open EdgeSt
B1	5879	Tom Mid St
C2	5879	Tom Mid St
C#2	6175	Crash2 St
D2	5875	Tom Hi St
D#2	6229	Ride2 St
E2	6283	China1 St
F2	6282	Ride Cup Mono2
F#2	2845	Tambourine1 Hit
G2	6293	Splash1 St
G#2	3223	Cowbell1
A2	6175	Crash2 St
A#2	2879	Vibraslap1
B2	6225	Ride1 St
C3	2979	Bongo1 Hi 1Fingr 1-2
C#3	2992	Bongo1 Lo 3Fingr 1-2
D3	2922	Conga1 Hi Tip
D#3	2928	Conga1 Hi Slap Open
E3	2926	Conga1 Hi Open 2
F3	3027	Timbale1 Hi 1
F#3	3027	Timbale1 Hi 1
G3	3106	Agogo1 Lo
G#3	3106	Agogo1 Lo
A3	3063	Cabasa1A 1
A#3	3059	Maracas1 Slur
B3	5226	Sd Brush Soft R
C4	5236	Sd Brush Swir St
C#4	3113	Guiro1 Short
D4	3112	Guiro1 Long
D#4	3217	Claves1
E4	2872	Wood Block
F4	2872	Wood Block
F#4	3034	Timbale1 Paila H
G4	3035	Timbale1 Paila L
G#4	2884	Triangle1 Mute
A4	2883	Triangle1 Open
A#4	2818	ShakerA 2
B4	2908	Sleigh Bell1
C5	2912	Wind Chime 1
C#5	4886	Sd Blues L1-3
D5	4841	Sd Funk Ay St
D#5	4902	Sd BluesHeart.R1-3
E5	4880	Sd Blues St1-2
F5	4416	Bd Low L
F#5	5177	Sd LdwHMono
G5	4434	Bd Dry2
G#5	5239	Sd Brush SwirAtt St
A5	4604	Bd Hip Deep
A#5	5215	Sd Roll Mono
B5	4402	Bd Normal 2R
C6	6214	Crash Brush2 St

Pop Latin Kit

Note	Wave Number	Wave Name
C0	3217	Claves1
C#0	3149	Cajon1 Kick
D0	3150	Cajon1 Slap
D#0	3151	Cajon1 Tip 1-2
E0	3217	Claves1
F0	2872	Wood Block
F#0	2889	Hand Clap1 St
G0	6230	Ride2 L
G#0	4230	HipHop Snap2
A0	2860	Castanet1
A#0	2922	Conga1 Hi Tip
B0	2923	Conga1 Hi Heel
C1	2924	Conga1 Hi Open 1-2
C#1	2927	Conga1 Hi Mute
D1	2928	Conga1 Hi Slap Open
D#1	2929	Conga1 Hi Slap
E1	2930	Conga1 Hi SlipMute1-2
F1	2933	Conga1 Lo Tip
F#1	2934	Conga1 Lo Heel
G1	2935	Conga1 Lo Open 1-2
G#1	2938	Conga1 Lo Mute
A1	2939	Conga1 Lo Slap Open
A#1	2939	Conga1 Lo Slap Open
B1	2936	Conga1 Lo Open 1
C2	2979	Bongo1 Hi 1Fingr 1-2
C#2	2982	Bongo1 Hi 3Fingr 1-2
D2	2985	Bongo1 Hi Rim
D#2	2986	Bongo1 Hi Tip
E2	2987	Bongo1 Hi Heel
F2	2988	Bongo1 Hi Slap
F#2	2989	Bongo1 Lo 1Fingr 1-2
G2	2992	Bongo1 Lo 3Fingr 1-2
G#2	2995	Bongo1 Lo Rim
A2	2996	Bongo1 Lo Tip
A#2	2992	Bongo1 Lo 3Fingr 1-2
B2	2988	Bongo1 Hi Slap
C3	3030	Timbale1 Lo 1-2
C#3	2967	Quinto1 Slap
D3	2966	Quinto1 Open
D#3	2922	Conga1 Hi Tip
E3	2970	Tumba Open
F3	3051	Paila L
F#3	3026	Timbale1 Hi 1-3
G3	3086	Pandeiro1 Open
G#3	3087	Pandeiro1 Thump
A3	3088	Pandeiro1 Tip
A#3	3089	Pandeiro1 Heel
B3	3052	Paila H
C4	3224	Cowbell2
C#4	3224	Cowbell2
D4	3105	Agogo1 Hi
D#4	3105	Agogo1 Hi
E4	3113	Guiro1 Short
F4	3112	Guiro1 Long
F#4	3118	MetalGuiro Short 1-2
G4	3121	MetalGuiro Long
G#4	2843	Tambourine1 Sw
A4	3102	Tmbourim Open
A#4	3104	Tmbourim Mute
B4	3103	Tmbourim Finger
C5	3058	Maracas1 Sw
C#5	2816	ShakerA 13
D5	3062	Cabasa1A 1-2
D#5	2974	Cuica1 Lo
E5	2975	Cuica1 Hi
F5	3223	Cowbell1
F#5	3236	Mambo Bell Body
G5	3440	Shekere Down
G#5	3442	Shekere Slap
A5	2884	Triangle1 Mute
A#5	2883	Triangle1 Open
B5	3220	Whistle
C6	2912	Wind Chime 1

Analog T9 Kit

Note	Wave Number	Wave Name
C0	4561	Bd T9-2
C#0	5393	Sd AnCR
D0	5353	Sd T9-5
D#0	4187	Clap AnSm
E0	5354	Sd T9Gate
F0	5206	Sd RockRoll St
F#0	5351	Sd T9-3
G0	5352	Sd T9-4
G#0	5354	Sd T9Gate
A0	4563	Bd T9-4
A#0	5353	Sd T9-5
B0	4560	Bd T9-1
C1	4562	Bd T9-3
C#1	5355	Sd T9Rim
D1	5349	Sd T9-1
D#1	4179	Clap T9-1
E1	5350	Sd T9-2
F1	6107	Tom T9 Lo
F#1	5766	HH Closed T9
G1	6107	Tom T9 Lo
G#1	5767	HH Open T9
A1	6107	Tom T9 Lo
A#1	5767	HH Open T9
B1	6106	Tom T9 Hi
C2	6106	Tom T9 Hi
C#2	6303	Crash T9-1
D2	6106	Tom T9 Hi
D#2	6329	Ride T9-1
E2	6287	China2
F2	6281	Ride Cup Mono
F#2	4258	Tambourine RX5
G2	6179	Crash3
G#2	3223	Cowbell1
A2	6180	Crash4
A#2	4242	Cowbell T8
B2	6231	Ride2 R
C3	4231	Conga T8
C#3	4231	Conga T8
D3	2922	Conga1 Hi Tip
D#3	2928	Conga1 Hi Slap Open
E3	2926	Conga1 Hi Open 2
F3	3026	Timbale1 Hi 1-3
F#3	3030	Timbale1 Lo 1-2
G3	4286	Analog Click
G#3	4231	Conga T8
A3	3062	Cabasa1A 1-2
A#3	3059	Maracas1 Slur
B3	2613	FxGun2
C4	2612	FxGun1
C#4	2629	Scratch H
D4	2631	Scratch Down
D#4	2512	Hi Q1
E4	2512	Hi Q1
F4	2513	Hi Q2
F#4	2630	Scratch L
G4	2630	Scratch L
G#4	2884	Triangle1 Mute
A4	2883	Triangle1 Open
A#4	4250	Analog Shaker
B4	2908	Sleigh Bell1
C5	2912	Wind Chime 1
C#5	4959	Sd Piccolo
D5	5380	Sd T8-5
D#5	5209	Sd RockRollD St
E5	5227	Sd Brush Med St
F5	4596	Bd BlpHd
F#5	5397	Sd Jungle1
G5	4629	Bd Sustain
G#5	5401	Sd D&B1
A5	4607	Bd Break2
A#5	5427	Sd Dist
B5	4630	Bd TekPower
C6	4615	Bd Distortion RM

Analog T8 Kit

Note	Wave Number	Wave Name
C0	4580	Bd T8-1
C#0	5393	Sd AnCR
D0	5379	Sd T8-4
D#0	5426	Sd Clap Analog
E0	5378	Sd T8-3
F0	6123	Tom T8
F#0	5380	Sd T8-5
G0	4582	Bd T8-3
G#0	5379	Sd T8-4
A0	4581	Bd T8-2
A#0	5378	Sd T8-3
B0	2256	T8 Kick Bass
C1	4581	Bd T8-2
C#1	5381	Sd T8 Rim
D1	5377	Sd T8-2
D#1	4179	Clap T9-1
E1	5376	Sd T8-1
F1	6123	Tom T8
F#1	5782	HH Closed T8-2
G1	6123	Tom T8
G#1	5781	HH Open T8-1
A1	6123	Tom T8
A#1	5781	HH Open T8-1
B1	6123	Tom T8
C2	6123	Tom T8
C#2	6305	Crash T8-1
D2	6123	Tom T8
D#2	6329	Ride T9-1
E2	6287	China2
F2	6281	Ride Cup Mono
F#2	4258	Tambourine RX5
G2	6295	Splash1 R
G#2	4242	Cowbell T8
A2	6180	Crash4
A#2	2879	Vibraslap1
B2	6231	Ride2 R
C3	4231	Conga T8
C#3	4231	Conga T8
D3	4231	Conga T8
D#3	4231	Conga T8
E3	4231	Conga T8
F3	3027	Timbale1 Hi 1
F#3	3031	Timbale1 Lo 1
G3	2490	Glass
G#3	2490	Glass
A3	3062	Cabasa1A 1-2
A#3	4272	MaracasT8-1
B3	2613	FxGun2
C4	2612	FxGun1
C#4	4250	Analog Shaker
D4	4250	Analog Shaker
D#4	4276	Claves T8-1
E4	2512	Hi Q1
F4	2513	Hi Q2
F#4	2630	Scratch L
G4	2630	Scratch L
G#4	2884	Triangle1 Mute
A4	2883	Triangle1 Open
A#4	4250	Analog Shaker
B4	2908	Sleigh Bell1
C5	2912	Wind Chime 1
C#5	5408	Sd Hip1
D5	5409	Sd Hip2
D#5	5411	Sd Hip Gate
E5	5417	Sd Break1
F5	4595	Bd Brip
F#5	5422	Sd FX1
G5	4626	Bd FxHammer
G#5	5437	Sd Hammer
A5	4627	Bd ZapHard
A#5	5430	Sd Garg L
B5	4630	Bd TekPower
C6	4636	Bd Slimy

Tekno Kit

Note	Wave Number	Wave Name
C0	4636	Bd Slimy
C#0	5355	Sd T9Rim
D0	5380	Sd T8-5
D#0	4179	Clap T9-1
E0	5351	Sd T9-3
F0	5395	Sd Human1
F#0	5410	Sd Hip3
G0	5352	Sd T9-4
G#0	5409	Sd Hip2
A0	4635	Bd ThickSkin
A#0	5350	Sd T9-2
B0	4613	Bd Distortion4
C1	4628	Bd ZapMid
C#1	5381	Sd T8 Rim
D1	5380	Sd T8-5
D#1	4179	Clap T9-1
E1	5433	Sd Syn
F1	6123	Tom T8
F#1	5810	HH Closed Lo-Fi
G1	6123	Tom T8
G#1	5811	HH Open Lo-Fi
A1	6123	Tom T8
A#1	5811	HH Open Lo-Fi
B1	6123	Tom T8
C2	6123	Tom T8
C#2	6305	Crash T8-1
D2	6123	Tom T8
D#2	6329	Ride T9-1
E2	6179	Crash3
F2	6281	Ride Cup Mono
F#2	4259	Tambourine AnCR
G2	6176	Crash2 L
G#2	4242	Cowbell T8
A2	6303	Crash T9-1
A#2	4242	Cowbell T8
B2	6310	Crash Syn
C3	4231	Conga T8
C#3	4231	Conga T8
D3	4231	Conga T8
D#3	4231	Conga T8
E3	4231	Conga T8
F3	3026	Timbale1 Hi 1-3
F#3	3030	Timbale1 Lo 1-2
G3	2490	Glass
G#3	2490	Glass
A3	3063	Cabasa1A 1
A#3	4272	MaracasT8-1
B3	2613	FxGun2
C4	2612	FxGun1
C#4	2629	Scratch H
D4	2631	Scratch Down
D#4	2512	Hi Q1
E4	2512	Hi Q1
F4	2513	Hi Q2
F#4	2630	Scratch L
G4	2630	Scratch L
G#4	2884	Triangle1 Mute
A4	2883	Triangle1 Open
A#4	4250	Analog Shaker
B4	2908	Sleigh Bell1
C5	4640	Bd Elec4
C#5	4643	Bd ElecComp3
D5	4645	Bd ElecFX2
D#5	4647	Bd ElecClick
E5	4648	Bd ElecPower1
F5	4649	Bd ElecPower2
F#5	4639	Bd Elec3
G5	4637	Bd Elec1
G#5	5321	Sd Elec6
A5	5322	Sd Elec7
A#5	5323	Sd Elec8
B5	5324	Sd Elec9
C6	5327	Sd Elec12

House Kit 1

Note	Wave Number	Wave Name
C0	4563	Bd T9-4
C#0	5381	Sd T8 Rim
D0	5380	Sd T8-5
D#0	2889	Hand Clap1 St
E0	5430	Sd Garg L
F0	5212	Sd LiveRoll St
F#0	5351	Sd T9-3
G0	5376	Sd T8-1
G#0	5353	Sd T9-5
A0	4560	Bd T9-1
A#0	5354	Sd T9Gate
B0	4561	Bd T9-2
C1	4561	Bd T9-2
C#1	5355	Sd T9Rim
D1	5349	Sd T9-1
D#1	4179	Clap T9-1
E1	5350	Sd T9-2
F1	6107	Tom T9 Lo
F#1	5780	HH Closed T8-1
G1	6107	Tom T9 Lo
G#1	5767	HH Open T9
A1	6107	Tom T9 Lo
A#1	5767	HH Open T9
B1	6106	Tom T9 Hi
C2	6106	Tom T9 Hi
C#2	6303	Crash T9-1
D2	6106	Tom T9 Hi
D#2	6329	Ride T9-1
E2	6179	Crash3
F2	6281	Ride Cup Mono
F#2	2845	Tambourine1 Hit
G2	6179	Crash3
G#2	3223	Cowbell1
A2	6175	Crash2 St
A#2	4242	Cowbell T8
B2	6225	Ride1 St
C3	2979	Bongo1 Hi 1Fingr 1-2
C#3	2992	Bongo1 Lo 3Fingr 1-2
D3	2922	Conga1 Hi Tip
D#3	2928	Conga1 Hi Slap Open
E3	2926	Conga1 Hi Open 2
F3	3027	Timbale1 Hi 1
F#3	3027	Timbale1 Hi 1
G3	3106	Agogo1 Lo
G#3	3106	Agogo1 Lo
A3	3063	Cabasa1A 1
A#3	3059	Maracas1 Slur
B3	2384	Vox Drum
C4	2384	Vox Drum
C#4	3113	Guiro1 Short
D4	3112	Guiro1 Long
D#4	3217	Claves1
E4	2872	Wood Block
F4	2872	Wood Block
F#4	2975	Cuica1 Hi
G4	2974	Cuica1 Lo
G#4	2884	Triangle1 Mute
A4	2883	Triangle1 Open
A#4	4250	Analog Shaker
B4	2908	Sleigh Bell1
C5	2912	Wind Chime 1
C#5	5421	Sd Break Roll
D5	2494	Noise Burst
D#5	2317	Vox Bell
E5	5405	Sd R&B1
F5	2323	VoxAlk
F#5	3525	Udu High
G5	2321	Trance Choir
G#5	2615	Swarm
A5	4435	Bd Pop
A#5	5406	Sd R&B1 Rim
B5	4603	Bd R&B2
C6	6179	Crash3

House Kit 2

Note	Wave Number	Wave Name
C0	4561	Bd T9-2
C#0	5381	Sd T8 Rim
D0	3352	Dohol High
D#0	4179	Clap T9-1
E0	5350	Sd T9-2
F0	5354	Sd T9Gate
F#0	5396	Sd Human2
G0	5422	Sd FX1
G#0	5438	Sd Lo-Fi
A0	4565	Bd T9 Hd2
A#0	5355	Sd T9Rim
B0	4562	Bd T9-3
C1	4564	Bd T9 Hd1
C#1	5355	Sd T9Rim
D1	5350	Sd T9-2
D#1	2494	Noise Burst
E1	4776	Sd Strong L1-4
F1	5433	Sd Syn
F#1	5766	HH Closed T9
G1	5433	Sd Syn
G#1	5767	HH Open T9
A1	5433	Sd Syn
A#1	5767	HH Open T9
B1	5433	Sd Syn
C2	5433	Sd Syn
C#2	6303	Crash T9-1
D2	5433	Sd Syn
D#2	6329	Ride T9-1
E2	6310	Crash Syn
F2	6281	Ride Cup Mono
F#2	2845	Tambourine1 Hit
G2	6305	Crash T8-1
G#2	3223	Cowbell1
A2	6179	Crash3
A#2	4242	Cowbell T8
B2	6225	Ride1 St
C3	2979	Bongo1 Hi 1Fingr 1-2
C#3	2992	Bongo1 Lo 3Fingr 1-2
D3	2923	Conga1 Hi Heel
D#3	2928	Conga1 Hi Slap Open
E3	2926	Conga1 Hi Open 2
F3	6131	Tom Syn1
F#3	6131	Tom Syn1
G3	4286	Analog Click
G#3	5439	Sd Rim SE
A3	3063	Cabasa1A 1
A#3	3059	Maracas1 Slur
B3	2384	Vox Drum
C4	2384	Vox Drum
C#4	4259	Tambourine AnCR
D4	4250	Analog Shaker
D#4	4276	Claves T8-1
E4	4258	Tambourine RX5
F4	4247	Cowbell RX11
F#4	4250	Analog Shaker
G4	2632	Scratch Hi F
G#4	2884	Triangle1 Mute
A4	2883	Triangle1 Open
A#4	4250	Analog Shaker
B4	2908	Sleigh Bell1
C5	2912	Wind Chime 1
C#5	3288	Tabla1 Bya
D5	3289	Tabla1 Nah
D#5	3290	Tabla1 Mute
E5	2317	Vox Bell
F5	4435	Bd Pop
F#5	3525	Udu High
G5	4557	Bd FX Gate
G#5	2494	Noise Burst
A5	4560	Bd T9-1
A#5	5421	Sd Break Roll
B5	6179	Crash3
C6	2616	TurnTable

HouseCompressedKit

Note	Wave Number	Wave Name
C0	4563	Bd T9-4
C#0	5381	Sd T8 Rim
D0	5380	Sd T8-5
D#0	2889	Hand Clap1 St
E0	5430	Sd Garg L
F0	5212	Sd LiveRoll St
F#0	5351	Sd T9-3
G0	5376	Sd T8-1
G#0	5353	Sd T9-5
A0	4560	Bd T9-1
A#0	5354	Sd T9Gate
B0	4561	Bd T9-2
C1	4562	Bd T9-3
C#1	5355	Sd T9Rim
D1	5349	Sd T9-1
D#1	4179	Clap T9-1
E1	5350	Sd T9-2
F1	6107	Tom T9 Lo
F#1	5780	HH Closed T8-1
G1	6107	Tom T9 Lo
G#1	5767	HH Open T9
A1	6107	Tom T9 Lo
A#1	5767	HH Open T9
B1	6106	Tom T9 Hi
C2	6106	Tom T9 Hi
C#2	6303	Crash T9-1
D2	6106	Tom T9 Hi
D#2	6329	Ride T9-1
E2	6179	Crash3
F2	6281	Ride Cup Mono
F#2	2845	Tambourine1 Hit
G2	6179	Crash3
G#2	3223	Cowbell1
A2	6175	Crash2 St
A#2	4242	Cowbell T8
B2	6225	Ride1 St
C3	2979	Bongo1 Hi 1Fingr 1-2
C#3	2992	Bongo1 Lo 3Fingr 1-2
D3	2922	Conga1 Hi Tip
D#3	2928	Conga1 Hi Slap Open
E3	2926	Conga1 Hi Open 2
F3	3027	Timbale1 Hi 1
F#3	3027	Timbale1 Hi 1
G3	3106	Agogo1 Lo
G#3	3106	Agogo1 Lo
A3	3063	Cabasa1A 1
A#3	3059	Maracas1 Slur
B3	2384	Vox Drum
C4	2384	Vox Drum
C#4	3113	Guiro1 Short
D4	3112	Guiro1 Long
D#4	3217	Claves1
E4	2872	Wood Block
F4	2872	Wood Block
F#4	2975	Cuica1 Hi
G4	2974	Cuica1 Lo
G#4	2884	Triangle1 Mute
A4	2883	Triangle1 Open
A#4	4250	Analog Shaker
B4	2908	Sleigh Bell1
C5	2912	Wind Chime 1
C#5	5421	Sd Break Roll
D5	2494	Noise Burst
D#5	2317	Vox Bell
E5	5405	Sd R&B1
F5	2323	VoxAlk
F#5	3525	Udu High
G5	2321	Trance Choir
G#5	2615	Swarm
A5	4435	Bd Pop
A#5	5406	Sd R&B1 Rim
B5	4603	Bd R&B2
C6	6179	Crash3

Big Kit

Note	Wave Number	Wave Name
C0	4557	Bd FX Gate
C#0	2992	Bongo1 Lo 3Fingr 1-2
D0	5181	Sd GM
D#0	2889	Hand Clap1 St
E0	5176	Sd Gate2
F0	5206	Sd RockRoll St
F#0	4944	Sd Rock Rim1 St
G0	4959	Sd Piccolo
G#0	4956	Sd Rock Flam St
A0	4439	Bd Room2
A#0	5182	Sd Rock Stick1 St
B0	4440	Bd Room3
C1	4556	Bd Gate
C#1	4963	Sd Mid Rim
D1	5175	Sd Gate1
D#1	4187	Clap AnSm
E1	4964	Sd Ambience
F1	6105	Tom Ambience Lo
F#1	5801	HH Closed D&B
G1	6105	Tom Ambience Lo
G#1	5802	HH Pedal D&B
A1	6105	Tom Ambience Lo
A#1	5803	HH Open D&B
B1	6104	Tom Ambience Hi
C2	6104	Tom Ambience Hi
C#2	6178	Crash2 RL
D2	6104	Tom Ambience Hi
D#2	6225	Ride1 St
E2	6283	China1 St
F2	6281	Ride Cup Mono
F#2	2845	Tambourine1 Hit
G2	6179	Crash3
G#2	3223	Cowbell1
A2	6175	Crash2 St
A#2	2879	Vibraslap1
B2	6228	Ride1 RL
C3	2979	Bongo1 Hi 1Fingr 1-2
C#3	2992	Bongo1 Lo 3Fingr 1-2
D3	2922	Conga1 Hi Tip
D#3	2928	Conga1 Hi Slap Open
E3	2926	Conga1 Hi Open 2
F3	4616	Bd +HH
F#3	4616	Bd +HH
G3	3106	Agogo1 Lo
G#3	3106	Agogo1 Lo
A3	3063	Cabasa1A 1
A#3	3059	Maracas1 Slur
B3	2613	FxGun2
C4	2612	FxGun1
C#4	2629	Scratch H
D4	2631	Scratch Down
D#4	3217	Claves1
E4	2872	Wood Block
F4	2872	Wood Block
F#4	2630	Scratch L
G4	2630	Scratch L
G#4	2884	Triangle1 Mute
A4	2883	Triangle1 Open
A#4	2818	Shaker A 2
B4	2908	Sleigh Bell1
C5	2912	Wind Chime 1
C#5	5427	Sd Dist
D5	5431	Sd FM
D#5	5432	Sd FM Rim
E5	5434	Sd Clappy
F5	4440	Bd Room3
F#5	5435	Sd Timbr
G5	4427	Bd Rock1 St
G#5	5439	Sd Rim SE
A5	4430	Bd Rock2 St
A#5	5421	Sd Break Roll
B5	4600	Bd D&B1
C6	4439	Bd Room2

Break Kit

Note	Wave Number	Wave Name
C0	4605	Bd Break Deep
C#0	4930	Sd Hip 1St
D0	5438	Sd Lo-Fi
D#0	5434	Sd Clappy
E0	5177	Sd LdwHMono
F0	5209	Sd RockRollD St
F#0	5175	Sd Gate1
G0	4962	Sd Mid
G#0	5178	Sd BreakRim
A0	4608	Bd Break Heavy
A#0	5415	Sd Hip Rim4
B0	4607	Bd Break2
C1	4606	Bd Break1
C#1	5412	Sd Hip Rim1
D1	5419	Sd Break3
D#1	5417	Sd Break1
E1	5418	Sd Break2
F1	5883	Tom Low St
F#1	5584	HH Closed Rock S R
G1	5883	Tom Low St
G#1	5597	HH Pedal Rock R
A1	5883	Tom Low St
A#1	5609	HH Half Open Rock R
B1	5875	Tom Hi St
C2	5875	Tom Hi St
C#2	6176	Crash2 L
D2	5875	Tom Hi St
D#2	6230	Ride2 L
E2	6284	China1 L
F2	6281	Ride Cup Mono
F#2	2845	Tambourine1 Hit
G2	6179	Crash3
G#2	3223	Cowbell1
A2	6177	Crash2 R
A#2	4247	Cowbell RX11
B2	6280	Ride Mono
C3	2979	Bongo1 Hi 1Fingr 1-2
C#3	2992	Bongo1 Lo 3Fingr 1-2
D3	2922	Conga1 Hi Tip
D#3	2928	Conga1 Hi Slap Open
E3	2926	Conga1 Hi Open 2
F3	2979	Bongo1 Hi 1Fingr 1-2
F#3	2992	Bongo1 Lo 3Fingr 1-2
G3	2926	Conga1 Hi Open 2
G#3	3106	Agogo1 Lo
A3	3063	Cabasa1A 1
A#3	3059	Maracas1 Slur
B3	3027	Timbale1 Hi 1
C4	3031	Timbale1 Lo 1
C#4	2629	Scratch H
D4	2631	Scratch Down
D#4	3217	Claves1
E4	2872	Wood Block
F4	2872	Wood Block
F#4	2630	Scratch L
G4	2630	Scratch L
G#4	2884	Triangle1 Mute
A4	2883	Triangle1 Open
A#4	2818	ShakerA 2
B4	2908	Sleigh Bell1
C5	2616	TurnTable
C#5	5421	Sd Break Roll
D5	2262	FM Bass5
D#5	2331	Mind Bell
E5	5422	Sd FX1
F5	4430	Bd Rock2 St
F#5	2446	LFO Seq
G5	2489	Ripper
G#5	2494	Noise Burst
A5	2617	Police
A#5	2330	Fairwave
B5	2615	Swarm
C6	2445	Radio Noise

Drum'n'Bass Kit

Note	Wave Number	Wave Name
C0	4604	Bd Hip Deep
C#0	2992	Bongo1 Lo 3Fingr 1-2
D0	5407	Sd R&B2
D#0	5435	Sd Timbr
E0	5403	Sd D&B3
F0	5437	Sd Hammer
F#0	2490	Glass
G0	4601	Bd D&B2
G#0	5538	HH Pedal 3 St
A0	4604	Bd Hip Deep
A#0	5571	HH Open2 St
B0	4609	Bd Break Hard
C1	4600	Bd D&B1
C#1	4963	Sd Mid Rim
D1	5401	Sd D&B1
D#1	2494	Noise Burst
E1	5402	Sd D&B2
F1	6105	Tom Ambience Lo
F#1	5801	HH Closed D&B
G1	6105	Tom Ambience Lo
G#1	5802	HH Pedal D&B
A1	6105	Tom Ambience Lo
A#1	5803	HH Open D&B
B1	6104	Tom Ambience Hi
C2	6104	Tom Ambience Hi
C#2	6176	Crash2 L
D2	6104	Tom Ambience Hi
D#2	6225	Ride1 St
E2	6287	China2
F2	6281	Ride Cup Mono
F#2	2845	Tambourine1 Hit
G2	6179	Crash3
G#2	3223	Cowbell1
A2	6175	Crash2 St
A#2	2879	Vibraslap1
B2	6225	Ride1 St
C3	2979	Bongo1 Hi 1Fingr 1-2
C#3	2992	Bongo1 Lo 3Fingr 1-2
D3	2922	Conga1 Hi Tip
D#3	2928	Conga1 Hi Slap Open
E3	2926	Conga1 Hi Open 2
F3	5404	Sd D&B4
F#3	5804	HH Reverse D&B
G3	3106	Agogo1 Lo
G#3	3106	Agogo1 Lo
A3	3063	Cabasa1A 1
A#3	3059	Maracas1 Slur
B3	2613	FxGun2
C4	2612	FxGun1
C#4	3113	Guiro1 Short
D4	3112	Guiro1 Long
D#4	3217	Claves1
E4	2504	Electric Perc8
F4	2498	Electric Perc2
F#4	2136	P50-1
G4	2509	Electric Perc13
G#4	2616	TurnTable
A4	2883	Triangle1 Open
A#4	2818	ShakerA 2
B4	2908	Sleigh Bell1
C5	2912	Wind Chime 1
C#5	5427	Sd Dist
D5	5431	Sd FM
D#5	5432	Sd FM Rim
E5	5434	Sd Clappy
F5	4600	Bd D&B1
F#5	5435	Sd Timbr
G5	4614	Bd Distortion5
G#5	5439	Sd Rim SE
A5	4613	Bd Distortion4
A#5	5410	Sd Hip3
B5	4636	Bd Slimy
C6	4616	Bd +HH

Acid Kit

Note	Wave Number	Wave Name
C0	4632	Bd Analog Tight
C#0	5381	Sd T8 Rim
D0	5399	Sd Jungle3
D#0	2889	Hand Clap1 St
E0	5376	Sd T8-1
F0	6131	Tom Syn1
F#0	4901	Sd BluesHeart L1-3
G0	4908	Sd BluesHeart 3R
G#0	4860	Sd SonA St1-3
A0	4403	Bd Funk St1-2
A#0	4844	Sd Basic St1-3
B0	4595	Bd Brp
C1	4563	Bd T9-4
C#1	5355	Sd T9Rim
D1	5431	Sd FM
D#1	4179	Clap T9-1
E1	5393	Sd AnCR
F1	6107	Tom T9 Lo
F#1	5805	HH Closed Tek
G1	6107	Tom T9 Lo
G#1	5805	HH Closed Tek
A1	6107	Tom T9 Lo
A#1	5806	HH Open Tek
B1	6106	Tom T9 Hi
C2	6106	Tom T9 Hi
C#2	6303	Crash T9-1
D2	6106	Tom T9 Hi
D#2	6329	Ride T9-1
E2	6179	Crash3
F2	6277	Ride Cup2 L
F#2	2845	Tambourine1 Hit
G2	6179	Crash3
G#2	3223	Cowbell1
A2	6296	Splash1 RL
A#2	4242	Cowbell T8
B2	6280	Ride Mono
C3	2979	Bongo1 Hi 1Fingr 1-2
C#3	2992	Bongo1 Lo 3Fingr 1-2
D3	2922	Conga1 Hi Tip
D#3	2928	Conga1 Hi Slap Open
E3	2926	Conga1 Hi Open 2
F3	3027	Timbale1 Hi 1
F#3	3027	Timbale1 Hi 1
G3	3105	Agogo1 Hi
G#3	3106	Agogo1 Lo
A3	3063	Cabasa1A 1
A#3	3059	Maracas1 Slur
B3	2613	FxGun2
C4	2612	FxGun1
C#4	2629	Scratch H
D4	2631	Scratch Down
D#4	2512	Hi Q1
E4	2512	Hi Q1
F4	2513	Hi Q2
F#4	2630	Scratch L
G4	2630	Scratch L
G#4	2884	Triangle1 Mute
A4	2883	Triangle1 Open
A#4	4250	Analog Shaker
B4	2908	Sleigh Bell1
C5	2912	Wind Chime 1
C#5	5353	Sd T9-5
D5	5353	Sd T9-5
D#5	5353	Sd T9-5
E5	5353	Sd T9-5
F5	4593	Bd Human1
F#5	5401	Sd D&B1
G5	2786	Acoustic Bass FX03
G#5	2182	DigiOsc4
A5	2181	DigiOsc3
A#5	5417	Sd Break1
B5	4597	Bd Jungle1
C6	4608	Bd Break Heavy

Jungle Kit

Note	Wave Number	Wave Name
C0	4598	Bd Jungle2
C#0	4963	Sd Mid Rim
D0	5399	Sd Jungle3
D#0	5399	Sd Jungle3
E0	4960	Sd Piccolo Rim1
F0	5215	Sd Roll Mono
F#0	5436	Sd Wood
G0	5407	Sd R&B2
G#0	5402	Sd D&B2
A0	4598	Bd Jungle2
A#0	5400	Sd JungleFX
B0	4580	Bd T8-1
C1	4597	Bd Jungle1
C#1	5415	Sd Hip Rim4
D1	5398	Sd Jungle2
D#1	5400	Sd JungleFX
E1	5399	Sd Jungle3
F1	5888	Tom Floor L
F#1	5582	HH Closed Rock Sw R
G1	5884	Tom Low L
G#1	5590	HH Pedal Rock Sw R
A1	5881	Tom Mid R
A#1	5605	HH Open Rock Sw R
B1	5881	Tom Mid R
C2	5877	Tom Hi R
C#2	6176	Crash2 L
D2	5877	Tom Hi R
D#2	6231	Ride2 R
E2	6287	China2
F2	6281	Ride Cup Mono
F#2	2845	Tambourine1 Hit
G2	6179	Crash3
G#2	3223	Cowbell1
A2	6175	Crash2 St
A#2	2879	Vibraslap1
B2	6225	Ride1 St
C3	2979	Bongo1 Hi 1Fingr 1-2
C#3	2992	Bongo1 Lo 3Fingr 1-2
D3	2922	Conga1 Hi Tip
D#3	2928	Conga1 Hi Slap Open
E3	2926	Conga1 Hi Open 2
F3	3289	Tabla1 Nah
F#3	3288	Tabla1 Bya
G3	3106	Agogo1 Lo
G#3	3106	Agogo1 Lo
A3	3063	Cabasa1A 1
A#3	3059	Maracas1 Slur
B3	3027	Timbale1 Hi 1
C4	3031	Timbale1 Lo 1
C#4	3113	Guiro1 Short
D4	3112	Guiro1 Long
D#4	3217	Claves1
E4	2872	Wood Block
F4	2872	Wood Block
F#4	2975	Cuica1 Hi
G4	2974	Cuica1 Lo
G#4	2884	Triangle1 Mute
A4	2883	Triangle1 Open
A#4	2818	ShakerA 2
B4	2908	Sleigh Bell1
C5	2912	Wind Chime 1
C#5	5804	HH Reverse D&B
D5	2628	RainLoop
D#5	2629	Scratch H
E5	2630	Scratch L
F5	4596	Bd BlpHd
F#5	5433	Sd Syn
G5	2493	Indus Tom
G#5	3086	Pandeiro1 Open
A5	2489	Ripper
A#5	2623	TelRing
B5	2635	Scratch Lo R
C6	2611	Tape Rewind

Electric Kit

Note	Wave Number	Wave Name
C0	4591	Bd AnCR
C#0	4595	Bd Brip
D0	5380	Sd T8-5
D#0	4187	Clap AnSm
E0	5413	Sd Hip Rim2
F0	5215	Sd Roll Mono
F#0	5376	Sd T8-1
G0	5393	Sd AnCR
G#0	5377	Sd T8-2
A0	4580	Bd T8-1
A#0	5379	Sd T8-4
B0	4595	Bd Brip
C1	4581	Bd T8-2
C#1	5381	Sd T8 Rim
D1	5378	Sd T8-3
D#1	4179	Clap T9-1
E1	4187	Clap AnSm
F1	6132	Tom Syn2
F#1	5782	HH Closed T8-2
G1	6132	Tom Syn2
G#1	5781	HH Open T8-1
A1	6132	Tom Syn2
A#1	5783	HH Open T8-2
B1	6132	Tom Syn2
C2	6132	Tom Syn2
C#2	6303	Crash T9-1
D2	6132	Tom Syn2
D#2	6329	Ride T9-1
E2	6179	Crash3
F2	6310	Crash Syn
F#2	6305	Crash T8-1
G2	6179	Crash3
G#2	5439	Sd Rim SE
A2	6175	Crash2 St
A#2	4242	Cowbell T8
B2	6310	Crash Syn
C3	6123	Tom T8
C#3	6123	Tom T8
D3	6123	Tom T8
D#3	6123	Tom T8
E3	6123	Tom T8
F3	2627	Applause
F#3	2618	Door Squeak
G3	2619	Heart Beat
G#3	2610	Bomb
A3	5811	HH Open Lo-Fi
A#3	2817	Shaker A 1
B3	2496	Zap2
C4	2495	Zap1
C#4	2629	Scratch H
D4	2630	Scratch L
D#4	2512	Hi Q1
E4	2512	Hi Q1
F4	2513	Hi Q2
F#4	2630	Scratch L
G4	2383	Hit Orchestra2
G#4	5814	HH Closed FX
A4	5815	HH Open FX
A#4	4250	Analog Shaker
B4	4250	Analog Shaker
C5	2616	TurnTable
C#5	5421	Sd Break Roll
D5	2262	FM Bass5
D#5	2331	Mind Bell
E5	5418	Sd Break2
F5	4430	Bd Rock2 St
F#5	2445	Radio Noise
G5	2489	Ripper
G#5	2494	Noise Burst
A5	2643	Scratch Spin
A#5	2459	Bell Choir
B5	2324	Hi-Lo
C6	2445	Radio Noise

Human Kit

Note	Wave Number	Wave Name
C0	4593	Bd Human1
C#0	2640	Scratch Vo F
D0	2382	Hit Uhh
D#0	2641	Scratch Vo R
E0	5400	Sd JungleFX
F0	5206	Sd RockRoll St
F#0	5417	Sd Break1
G0	5393	Sd AnCR
G#0	5349	Sd T9-1
A0	4629	Bd Sustain
A#0	5188	Sd Hip Stick1
B0	4594	Bd Human2
C1	4594	Bd Human2
C#1	5436	Sd Wood
D1	5395	Sd Human1
D#1	5429	Sd Garg H
E1	5396	Sd Human2
F1	4593	Bd Human1
F#1	5816	HH Open Human
G1	4593	Bd Human1
G#1	5816	HH Open Human
A1	4593	Bd Human1
A#1	5816	HH Open Human
B1	4593	Bd Human1
C2	4593	Bd Human1
C#2	2494	Noise Burst
D2	4593	Bd Human1
D#2	6305	Crash T8-1
E2	6287	China2
F2	6281	Ride Cup Mono
F#2	2639	Scratch Sd R
G2	6293	Splash1 St
G#2	2384	Vox Drum
A2	6180	Crash4
A#2	4261	Electric Tambourine2
B2	2381	Stab Aah
C3	2979	Bongo1 Hi 1Fingr 1-2
C#3	2992	Bongo1 Lo 3Fingr 1-2
D3	2922	Conga1 Hi Tip
D#3	2928	Conga1 Hi Slap Open
E3	2926	Conga1 Hi Open 2
F3	3026	Timbale1 Hi 1-3
F#3	3030	Timbale1 Lo 1-2
G3	3106	Agogo1 Lo
G#3	3106	Agogo1 Lo
A3	3063	Cabasa1A 1
A#3	3059	Maracas1 Slur
B3	2613	FxGun2
C4	2610	Bomb
C#4	2629	Scratch H
D4	2631	Scratch Down
D#4	2634	Scratch Lo F
E4	2635	Scratch Lo R
F4	2513	Hi Q2
F#4	2630	Scratch L
G4	2630	Scratch L
G#4	2884	Triangle1 Mute
A4	2883	Triangle1 Open
A#4	2818	Shaker A 2
B4	2908	Sleigh Bell1
C5	2616	TurnTable
C#5	4946	Sd Rock Rim1 R
D5	2620	Helicopter
D#5	2379	Stab Hard
E5	5175	Sd Gate1
F5	4427	Bd Rock1 St
F#5	2631	Scratch Down
G5	4590	Bd AnSm
G#5	2332	Sonar1
A5	3483	Wa Taiko
A#5	3483	Wa Taiko
B5	2374	HH Hit
C6	2380	Stab Organ2

Hard Kit

Note	Wave Number	Wave Name
C0	4612	Bd Distortion3
C#0	5436	Sd Wood
D0	5175	Sd Gate1
D#0	2889	Hand Clap1 St
E0	5176	Sd Gate2
F0	5215	Sd Roll Mono
F#0	5426	Sd Clap Analog
G0	5410	Sd Hip3
G#0	2489	Ripper
A0	4615	Bd Distortion RM
A#0	5381	Sd T8 Rim
B0	4611	Bd Distortion2
C1	4610	Bd Distortion1
C#1	4963	Sd Mid Rim
D1	5427	Sd Dist
D#1	2494	Noise Burst
E1	5423	Sd FX2
F1	6135	Tom Dist Lo
F#1	5766	HH Closed T9
G1	6135	Tom Dist Lo
G#1	5767	HH Open T9
A1	6135	Tom Dist Lo
A#1	5767	HH Open T9
B1	6134	Tom Dist Hi
C2	6134	Tom Dist Hi
C#2	6303	Crash T9-1
D2	6134	Tom Dist Hi
D#2	6329	Ride T9-1
E2	6287	China2
F2	6281	Ride Cup Mono
F#2	4259	Tambourine AnCR
G2	6179	Crash3
G#2	4242	Cowbell T8
A2	6175	Crash2 St
A#2	2879	Vibraslap1
B2	6225	Ride1 St
C3	5435	Sd Timbr
C#3	5435	Sd Timbr
D3	2922	Conga1 Hi Tip
D#3	2928	Conga1 Hi Slap Open
E3	2926	Conga1 Hi Open 2
F3	4616	Bd +HH
F#3	4616	Bd +HH
G3	2490	Glass
G#3	2490	Glass
A3	3063	Cabasa1A 1
A#3	3059	Maracas1 Slur
B3	2613	FxGun2
C4	2612	FxGun1
C#4	2629	Scratch H
D4	2631	Scratch Down
D#4	2512	Hi Q1
E4	2512	Hi Q1
F4	2513	Hi Q2
F#4	2630	Scratch L
G4	2630	Scratch L
G#4	2884	Triangle1 Mute
A4	2883	Triangle1 Open
A#4	4250	Analog Shaker
B4	2908	Sleigh Bell1
C5	2912	Wind Chime 1
C#5	5427	Sd Dist
D5	5431	Sd FM
D#5	5432	Sd FM Rim
E5	5434	Sd Clappy
F5	4626	Bd FxHammer
F#5	2493	Indus Tom
G5	4600	Bd D&B1
G#5	2493	Indus Tom
A5	4440	Bd Room3
A#5	2493	Indus Tom
B5	4563	Bd T9-4
C6	5437	Sd Hammer

Distorted Kit

Note	Wave Number	Wave Name
C0	4286	Analog Click
C#0	5224	Sd Brush Soft St
D0	5236	Sd Brush Swir St
D#0	5227	Sd Brush Med St
E0	5239	Sd Brush SwirAtt St
F0	5212	Sd LiveRoll St
F#0	2860	Castanet1
G0	4812	Sd Normal 1St
G#0	2855	Stick1
A0	4432	Bd Rock2 R
A#0	4915	Sd Tight 1St
B0	4606	Bd Break1
C1	4432	Bd Rock2 R
C#1	5187	Sd Rock Stick2 R
D1	4871	Sd SonA 1L
D#1	2890	Hand Clap1 L
E1	4960	Sd Piccolo Rim1
F1	6105	Tom Ambience Lo
F#1	5593	HH Closed Rock 2R
G1	6105	Tom Ambience Lo
G#1	5597	HH Pedal Rock R
A1	6105	Tom Ambience Lo
A#1	5607	HH Open Rock R
B1	6104	Tom Ambience Hi
C2	6104	Tom Ambience Hi
C#2	6176	Crash2 L
D2	6104	Tom Ambience Hi
D#2	6231	Ride2 R
E2	6284	China1 L
F2	6278	Ride Cup2 R
F#2	2843	Tambourine1 Sw
G2	6295	Splash1 R
G#2	3235	Mambo Bell2
A2	6176	Crash2 L
A#2	2879	Vibraslap1
B2	6228	Ride1 RL
C3	2979	Bongo1 Hi 1Fingr 1-2
C#3	2992	Bongo1 Lo 3Fingr 1-2
D3	2922	Conga1 Hi Tip
D#3	2928	Conga1 Hi Slap Open
E3	2926	Conga1 Hi Open 2
F3	3026	Timbale1 Hi 1-3
F#3	3030	Timbale1 Lo 1-2
G3	3105	Agogo1 RL
G#3	3106	Agogo1 Lo
A3	3062	Cabasa1A 1-2
A#3	3059	Maracas1 Slur
B3	3220	Whistle
C4	3220	Whistle
C#4	3113	Guiro1 Short
D4	3112	Guiro1 Long
D#4	3217	Claves1
E4	2872	Wood Block
F4	2872	Wood Block
F#4	2649	Scratch Combi2
G4	2633	Scratch Hi R
G#4	2884	Triangle1 Mute
A4	2883	Triangle1 Open
A#4	2817	Shaker A 1
B4	2908	Sleigh Bell1
C5	2912	Wind Chime 1
C#5	4959	Sd Piccolo
D5	5180	Sd Heavy
D#5	5426	Sd Clap Analog
E5	4960	Sd Piccolo Rim1
F5	4439	Bd Room2
F#5	4962	Sd Mid
G5	4440	Bd Room3
G#5	4963	Sd Mid Rim
A5	4556	Bd Gate
A#5	5175	Sd Gate1
B5	4557	Bd FX Gate
C6	4600	Bd D&B1

Ambient Kit

Note	Wave Number	Wave Name
C0	4595	Bd Brip
C#0	2513	Hi Q2
D0	4961	Sd Piccolo Rim2
D#0	2512	Hi Q1
E0	5393	Sd AnCR
F0	6131	Tom Syn1
F#0	5812	HH Closed Syn
G0	6131	Tom Syn1
G#0	5814	HH Closed FX
A0	6132	Tom Syn2
A#0	5813	HH Open Syn
B0	4591	Bd AnCR
C1	4560	Bd T9-1
C#1	5190	Sd Hip Stick3
D1	5397	Sd Jungle1
D#1	4179	Clap T9-1
E1	5397	Sd Jungle1
F1	6123	Tom T8
F#1	5782	HH Closed T8-2
G1	6123	Tom T8
G#1	5781	HH Open T8-1
A1	6123	Tom T8
A#1	5783	HH Open T8-2
B1	6123	Tom T8
C2	6123	Tom T8
C#2	6310	Crash Syn
D2	6123	Tom T8
D#2	6329	Ride T9-1
E2	6179	Crash3
F2	6281	Ride Cup Mono
F#2	2845	Tambourine1 Hit
G2	6179	Crash3
G#2	4242	Cowbell T8
A2	6175	Crash2 St
A#2	2879	Vibraslap1
B2	6225	Ride1 St
C3	2979	Bongo1 Hi 1Fingr 1-2
C#3	2992	Bongo1 Lo 3Fingr 1-2
D3	2922	Conga1 Hi Tip
D#3	2928	Conga1 Hi Slap Open
E3	2926	Conga1 Hi Open 2
F3	3026	Timbale1 Hi 1-3
F#3	3030	Timbale1 Lo 1-2
G3	2490	Glass
G#3	2490	Glass
A3	3063	Cabasa1A 1
A#3	4272	MaracasT8-1
B3	2624	Bird
C4	2335	Engine Room St
C#4	2510	Electric Perc14
D4	2626	Gunshot
D#4	4276	Claves T8-1
E4	2872	Wood Block
F4	2872	Wood Block
F#4	4259	Tambourine AnCR
G4	4248	Cowbell AnCR
G#4	2884	Triangle1 Mute
A4	2883	Triangle1 Open
A#4	4250	Analog Shaker
B4	2908	Sleigh Bell1
C5	2912	Wind Chime 1
C#5	5380	Sd T8-5
D5	2332	Sonar1
D#5	5380	Sd T8-5
E5	2332	Sonar1
F5	2386	Bubble
F#5	5380	Sd T8-5
G5	2386	Bubble
G#5	5380	Sd T8-5
A5	2322	Eery
A#5	5380	Sd T8-5
B5	2385	FX Chime
C6	2385	FX Chime

Garage Kit

Note	Wave Number	Wave Name
C0	4631	Bd Hard Long
C#0	4560	Bd T9-1
D0	4636	Bd Slimy
D#0	4633	Bd Analog Hard
E0	4613	Bd Distortion4
F0	4643	Bd ElecComp3
F#0	4604	Bd Hip Deep
G0	4626	Bd FxHammer
G#0	4562	Bd T9-3
A0	4582	Bd T8-3
A#0	4629	Bd Sustain
B0	4603	Bd R&B2
C1	4564	Bd T9 Hd1
C#1	4636	Bd Slimy
D1	5376	Sd T8-1
D#1	5381	Sd T8 Rim
E1	5434	Sd Clappy
F1	4885	Sd Blues 3St
F#1	5553	HH Open 2St
G1	5782	HH Closed T8-2
G#1	5553	HH Open 2St
A1	5783	HH Open T8-2
A#1	5553	HH Open 2St
B1	5783	HH Open T8-2
C2	4187	Clap AnSm
C#2	6175	Crash2 St
D2	6303	Crash T9-1
D#2	6225	Ride1 St
E2	6329	Ride T9-1
F2	4286	Analog Click
F#2	4276	Claves T8-1
G2	4187	Clap AnSm
G#2	4179	Clap T9-1
A2	4250	Analog Shaker
A#2	4231	Conga T8
B2	4231	Conga T8
C3	5393	Sd AnCR
C#3	5206	Sd RockRoll St
D3	3105	Agogo1 Hi
D#3	6286	China1 RL
E3	2513	Hi Q2
F3	2512	Hi Q1
F#3	2496	Zap2
G3	2495	Zap1
G#3	2496	Zap2
A3	2618	Door Squeak
A#3	2650	Scratch Combi3
B3	2732	AcousticGtr FX27 St
C4	782	Play FX Mix
C#4	2632	Scratch Hi F
D4	244	Wr1 Hard+
D#4	244	Wr1 Hard+
E4	244	Wr1 Hard+
F4	2390	Resonance X-Fade
F#4	2332	Sonar1
G4	2384	Vox Drum
G#4	2384	Vox Drum
A4	2384	Vox Drum
A#4	5813	HH Open Syn
B4	5812	HH Closed Syn
C5	2138	Tri Wave
C#5	2138	Tri Wave
D5	2138	Tri Wave
D#5	2138	Tri Wave
E5	2138	Tri Wave
F5	2138	Tri Wave
F#5	2138	Tri Wave
G5	2138	Tri Wave
G#5	2138	Tri Wave
A5	2138	Tri Wave
A#5	2138	Tri Wave
B5	2138	Tri Wave
C6	2138	Tri Wave

Synth Pop Kit

Note	Wave Number	Wave Name
C0	4715	Bd HipHop8
C#0	4560	Bd T9-1
D0	4595	Bd Brip
D#0	4609	Bd Break Hard
E0	4644	Bd ElecFX1
F0	4646	Bd ElecGate
F#0	4645	Bd ElecFX2
G0	4611	Bd Distortion2
G#0	4635	Bd ThickSkin
A0	4642	Bd ElecComp2
A#0	4638	Bd Elec2
B0	4647	Bd ElecClick
C1	4647	Bd ElecClick
C#1	5355	Sd T9Rim
D1	5327	Sd Elec12
D#1	4179	Clap T9-1
E1	5323	Sd Elec8
F1	6107	Tom T9 Lo
F#1	5766	HH Closed T9
G1	6107	Tom T9 Lo
G#1	5767	HH Open T9
A1	6107	Tom T9 Lo
A#1	5767	HH Open T9
B1	6106	Tom T9 Hi
C2	6106	Tom T9 Hi
C#2	6303	Crash T9-1
D2	6106	Tom T9 Hi
D#2	6329	Ride T9-1
E2	6303	Crash T9-1
F2	6329	Ride T9-1
F#2	4261	Electric Tambourine2
G2	6303	Crash T9-1
G#2	4249	Electric Cowbell
A2	6303	Crash T9-1
A#2	4260	Electric Tambourine1
B2	6329	Ride T9-1
C3	2501	Electric Perc5
C#3	2500	Electric Perc4
D3	2508	Electric Perc12
D#3	2502	Electric Perc6
E3	2497	Electric Perc1
F3	2491	Bell FX1
F#3	2492	Bell FX2
G3	2646	Scratch Attack
G#3	2647	Scratch R&B
A3	3062	Cabasa1A 1-2
A#3	3059	Maracas1 Slur
B3	2510	Electric Perc14
C4	2511	Electric Perc15
C#4	2826	Shaker Hip2
D4	2499	Electric Perc3
D#4	2503	Electric Perc7
E4	2504	Electric Perc8
F4	2505	Electric Perc9
F#4	2506	Electric Perc10
G4	2509	Electric Perc13
G#4	2884	Triangle1 Mute
A4	2883	Triangle1 Open
A#4	4275	Electric Maracas
B4	4279	Electric Triangle
C5	2507	Electric Perc11
C#5	5316	Sd Elec1
D5	5324	Sd Elec9
D#5	5325	Sd Elec10
E5	5326	Sd Elec11
F5	5317	Sd Elec2
F#5	5318	Sd Elec3
G5	5319	Sd Elec4
G#5	5320	Sd Elec5
A5	5321	Sd Elec6
A#5	5322	Sd Elec7
B5	4188	Electric Clap1
C6	4189	Electric Clap2

Orchestra Kit

Note	Wave Number	Wave Name
C0	4286	Analog Click
C#0	5228	Sd Brush Med L
D0	5238	Sd Brush Swir R
D#0	5228	Sd Brush Med L
E0	5241	Sd Brush SwirAtt R
F0	5287	Sd Orch Roll St
F#0	2860	Castanet1
G0	5255	Sd Orcha 1 St
G#0	2855	Stick1
A0	4529	Bd GranCasaA Mute St
A#0	5260	Sd Orcha 2 L
B0	4529	Bd GranCasaA Mute St
C1	4526	Bd GranCasaA Open St
C#1	5200	Sd Closed Rim R
D1	5256	Sd Orcha 2 St
D#1	2889	Hand Clap1 St
E1	5265	Sd Orcha 2 St
F1	354	Timpani1 Sw St
F#1	5515	HH Closed 1-4St
G1	354	Timpani1 Sw St
G#1	5540	HH Pedal 1-3 R
A1	354	Timpani1 Sw St
A#1	5551	HH Open 1-2St
B1	354	Timpani1 Sw St
C2	354	Timpani1 Sw St
C#2	6219	Hand Cymbal Open St
D2	354	Timpani1 Sw St
D#2	6225	Ride1 St
E2	6283	China1 St
F2	6253	Ride Cup1 St
F#2	2845	Tambourine1 Hit
G2	6222	Hand Cymbal Mute St
G#2	3224	Cowbell2
A2	6171	Crash1 St
A#2	2879	Vibraslap1
B2	6229	Ride2 St
C3	2979	Bongo1 Hi 1Fingr 1-2
C#3	2992	Bongo1 Lo 3Fingr 1-2
D3	2922	Conga1 Hi Tip
D#3	2926	Conga1 Hi Open 2
E3	2970	Tumba Open
F3	3026	Timbale1 Hi 1-3
F#3	3030	Timbale1 Lo 1-2
G3	3105	Agogo1 Hi
G#3	3106	Agogo1 Lo
A3	3062	Cabasa1A 1-2
A#3	3059	Maracas1 Slur
B3	3220	Whistle
C4	3220	Whistle
C#4	3113	Guiro1 Short
D4	3112	Guiro1 Long
D#4	3217	Claves1
E4	2872	Wood Block
F4	2872	Wood Block
F#4	2975	Cuica1 Hi
G4	2974	Cuica1 Lo
G#4	2884	Triangle1 Mute
A4	2883	Triangle1 Open
A#4	2817	Shaker A 1
B4	2908	Sleigh Bell1
C5	2912	Wind Chime 1
C#5	2872	Wood Block
D5	2872	Wood Block
D#5	2872	Wood Block
E5	2872	Wood Block
F5	2872	Wood Block
F#5	2872	Wood Block
G5	2872	Wood Block
G#5	2872	Wood Block
A5	2872	Wood Block
A#5	2872	Wood Block
B5	2872	Wood Block
C6	2872	Wood Block

Drum Machines Kit

Note	Wave Number	Wave Name
C0	4631	Bd Hard Long
C#0	4630	Bd TekPower
D0	4614	Bd Distortion5
D#0	4612	Bd Distortion3
E0	4610	Bd Distortion1
F0	4600	Bd D&B1
F#0	4595	Bd Brip
G0	4590	Bd AnSm
G#0	4581	Bd T8-2
A0	4582	Bd T8-3
A#0	4566	Bd T9 Hd3
B0	4561	Bd T9-2
C1	4562	Bd T9-3
C#1	5355	Sd T9Rim
D1	5349	Sd T9-1
D#1	4179	Clap T9-1
E1	5352	Sd T9-4
F1	6107	Tom T9 Lo
F#1	5766	HH Closed T9
G1	6107	Tom T9 Lo
G#1	5767	HH Open T9
A1	6107	Tom T9 Lo
A#1	5767	HH Open T9
B1	6107	Tom T9 Lo
C2	6107	Tom T9 Lo
C#2	6303	Crash T9-1
D2	4231	Conga T8
D#2	6329	Ride T9-1
E2	4231	Conga T8
F2	4286	Analog Click
F#2	4276	Claves T8-1
G2	4272	MaracasT8-1
G#2	4259	Tambourine AnCR
A2	4250	Analog Shaker
A#2	4242	Cowbell T8
B2	4248	Cowbell AnCR
C3	5376	Sd T8-1
C#3	5377	Sd T8-2
D3	5378	Sd T8-3
D#3	5393	Sd AnCR
E3	5397	Sd Jungle1
F3	5401	Sd D&B1
F#3	5408	Sd Hip1
G3	5405	Sd R&B1
G#3	5407	Sd R&B2
A3	5408	Sd Hip1
A#3	5436	Sd Wood
B3	5435	Sd Timbr
C4	5780	HH Closed T8-1
C#4	5781	HH Open T8-1
D4	5782	HH Closed T8-2
D#4	5783	HH Open T8-2
E4	5546	HH Pedal 3 R
F4	5559	HH Open 2R
F#4	5559	HH Open 2R
G4	5810	HH Closed Lo-Fi
G#4	5811	HH Open Lo-Fi
A4	5812	HH Closed Syn
A#4	5813	HH Open Syn
B4	4250	Analog Shaker
C5	4258	Tambourine RX5
C#5	4258	Tambourine RX5
D5	4249	Electric Cowbell
D#5	4231	Conga T8
E5	4279	Electric Triangle
F5	4276	Claves T8-1
F#5	4250	Analog Shaker
G5	4188	Electric Clap1
G#5	4189	Electric Clap2
A5	4259	Tambourine AnCR
A#5	4242	Cowbell T8
B5	4286	Analog Click
C6	4247	Cowbell RX11

Rock Multiple Kits

Note	Wave Number	Wave Name
C0	4394	Bd Normal St1-2
C#0	5182	Sd Rock Stick1 St
D0	4947	Sd Rock Open2 St
D#0	5206	Sd RockRoll St
E0	4938	Sd Rock Open1 St
F0	5883	Tom Low St
F#0	5563	HH Closed Foot St
G0	5883	Tom Low St
G#0	5538	HH Pedal 3 St
A0	5879	Tom Mid St
A#0	5553	HH Open 2St
B0	5875	Tom Hi St
C1	4430	Bd Rock2 St
C#1	5182	Sd Rock Stick1 St
D1	4947	Sd Rock Open2 St
D#1	2889	Hand Clap1 St
E1	4950	Sd Rock Mute2 St
F1	5899	Tom Rock Low St
F#1	5575	HH Closed Rock Sw St
G1	5899	Tom Rock Low St
G#1	5587	HH Pedal Rock Sw St
A1	5895	Tom Rock Mid St
A#1	5599	HH Open Rock Sw St
B1	5895	Tom Rock Mid St
C2	5891	Tom Rock Hi St
C#2	6175	Crash2 St
D2	5891	Tom Rock Hi St
D#2	6225	Ride1 St
E2	6283	China1 St
F2	6253	Ride Cup1 St
F#2	2843	Tambourine1 Sw
G2	6293	Splash1 St
G#2	3223	Cowbell1
A2	6175	Crash2 St
A#2	2817	ShakerA 1
B2	6225	Ride1 St
C3	4427	Bd Rock1 St
C#3	5185	Sd Rock Stick2 St
D3	4938	Sd Rock Open1 St
D#3	4179	Clap T9-1
E3	4941	Sd Rock Mute1 St
F3	5899	Tom Rock Low St
F#3	5575	HH Closed Rock Sw St
G3	5899	Tom Rock Low St
G#3	5595	HH Pedal Rock St
A3	5895	Tom Rock Mid St
A#3	5603	HH Half Open Rock St
B3	5895	Tom Rock Mid St
C4	5891	Tom Rock Hi St
C#4	6175	Crash2 St
D4	5891	Tom Rock Hi St
D#4	6230	Ride2 L
E4	6283	China1 St
F4	6253	Ride Cup1 St
F#4	2845	Tambourine1 Hit
G4	6293	Splash1 St
G#4	3235	Mambo Bell2
A4	6175	Crash2 St
A#4	3440	Shekere Down
B4	6231	Ride2 R
C5	4403	Bd Funk St1-2
C#5	5182	Sd Rock Stick1 St
D5	4944	Sd Rock Rim1 St
D#5	4956	Sd Rock Flam St
E5	4953	Sd Rock Rim2 St
F5	5887	Tom Floor St
F#5	5519	HH Closed 4St
G5	5883	Tom Low St
G#5	5538	HH Pedal 3 St
A5	5879	Tom Mid St
A#5	5571	HH Open2 St
B5	5879	Tom Mid St
C6	5875	Tom Hi St

HipHopMultipleKits

Note	Wave Number	Wave Name
C0	4582	Bd T8-3
C#0	5381	Sd T8 Rim
D0	5497	Sd HipHop9
D#0	4179	Clap T9-1
E0	5495	Sd HipHop7
F0	4582	Bd T8-3
F#0	5805	HH Closed Tek
G0	4582	Bd T8-3
G#0	5806	HH Open Tek
A0	4582	Bd T8-3
A#0	5806	HH Open Tek
B0	4582	Bd T8-3
C1	4604	Bd Hip Deep
C#1	5191	Sd Hip Stick4
D1	5412	Sd Hip Rim1
D#1	4211	HipHop Clap1
E1	5409	Sd Hip2
F1	6123	Tom T8
F#1	5782	HH Closed T8-2
G1	6123	Tom T8
G#1	5798	HH Open AnCR
A1	6123	Tom T8
A#1	5781	HH Open T8-1
B1	6123	Tom T8
C2	6123	Tom T8
C#2	6303	Crash T9-1
D2	6123	Tom T8
D#2	6310	Crash Syn
E2	6310	Crash Syn
F2	6305	Crash T8-1
F#2	4258	Tambourine RX5
G2	6295	Splash1 R
G#2	4242	Cowbell T8
A2	6303	Crash T9-1
A#2	4248	Cowbell AnCR
B2	6329	Ride T9-1
C3	4604	Bd Hip Deep
C#3	5192	Sd Hip Stick5
D3	5413	Sd Hip Rim2
D#3	4212	HipHop Clap2
E3	5408	Sd Hip1
F3	6107	Tom T9 Lo
F#3	5794	HH Closed RX5
G3	6107	Tom T9 Lo
G#3	5797	HH Closed AnCR
A3	6107	Tom T9 Lo
A#3	5783	HH Open T8-2
B3	6107	Tom T9 Lo
C4	6106	Tom T9 Hi
C#4	6177	Crash2 R
D4	6106	Tom T9 Hi
D#4	6305	Crash T8-1
E4	6310	Crash Syn
F4	6305	Crash T8-1
F#4	2845	Tambourine1 Hit
G4	6285	China1 R
G#4	4247	Cowbell RX11
A4	6176	Crash2 L
A#4	3223	Cowbell1
B4	6231	Ride2 R
C5	4604	Bd Hip Deep
C#5	5508	Sd HipHop Rim4
D5	5490	Sd HipHop2
D#5	4212	HipHop Clap2
E5	5416	Sd Hip Rim5
F5	6135	Tom Dist Lo
F#5	5807	HH Closed Hip
G5	6135	Tom Dist Lo
G#5	5808	HH Pedal Hip
A5	6134	Tom Dist Hi
A#5	5809	HH Open Hip
B5	6134	Tom Dist Hi
C6	6134	Tom Dist Hi

Percussion Kit

Note	Wave Number	Wave Name
C0	3483	Wa Taiko
C#0	3525	Udu High
D0	3274	Djembe1 Open
D#0	2966	Quinto1 Open
E0	3526	Udu Low
F0	3524	Udu Finger
F#0	3525	Udu High
G0	3288	Tabla1 Bya
G#0	3102	Tmbourim Open
A0	3290	Tabla1 Mute
A#0	3289	Tabla1 Nah
B0	3290	Tabla1 Mute
C1	354	Timpani1 Sw St
C#1	2382	Hit Uhh
D1	2979	Bongo1 Hi 1Fingr 1-2
D#1	4179	Clap T9-1
E1	2884	Triangle1 Mute
F1	2883	Triangle1 Open
F#1	2860	Castanet1
G1	2860	Castanet1
G#1	2860	Castanet1
A1	3112	Guiro1 Long
A#1	3114	Guiro1 Swp
B1	3113	Guiro1 Short
C2	2879	Vibraslap1
C#2	3217	Claves1
D2	4276	Claves T8-1
D#2	2974	Cuica1 Lo
E2	2975	Cuica1 Hi
F2	3030	Timbale1 Lo 1-2
F#2	2872	Wood Block
G2	3032	Timbale1 Lo 2
G#2	2872	Wood Block
A2	3026	Timbale1 Hi 1-3
A#2	3238	ChaCha Bell
B2	3028	Timbale1 Hi 2
C3	3035	Timbale1 Paila L
C#3	3035	Timbale1 Paila L
D3	3034	Timbale1 Paila H
D#3	3234	Mambo Bell1
E3	2992	Bongo1 Lo 3Fingr 1-2
F3	2992	Bongo1 Lo 3Fingr 1-2
F#3	2906	Handbell L
G3	2979	Bongo1 Hi 1Fingr 1-2
G#3	2907	Handbell H
A3	2979	Bongo1 Hi 1Fingr 1-2
A#3	3106	Agogo1 Lo
B3	3105	Agogo1 Hi
C4	2923	Conga1 Hi Heel
C#4	2922	Conga1 Hi Tip
D4	2971	Tumba Slap
D#4	3059	Maracas1 Slur
E4	2970	Tumba Open
F4	2923	Conga1 Hi Heel
F#4	2922	Conga1 Hi Tip
G4	2928	Conga1 Hi Slap Open
G#4	2817	Shaker A 1
A4	2926	Conga1 Hi Open 2
A#4	3063	Cabasa1A 1
B4	3062	Cabasa1A 1-2
C5	2923	Conga1 Hi Heel
C#5	2922	Conga1 Hi Tip
D5	2967	Quinto1 Slap
D#5	2817	ShakerA 1
E5	2968	Quinto2 Open
F5	3073	Caxixi 1-2
F#5	2844	Tambourine1 Shake
G5	2845	Tambourine1 Hit
G#5	2843	Tambourine1 Sw
A5	2845	Tambourine1 Hit
A#5	2908	Sleigh Bell1
B5	3220	Whistle
C6	3220	Whistle

LatinPercussionKit

Note	Wave Number	Wave Name
C0	4421	Bd L Son St
C#0	5185	Sd Rock Stick2 St
D0	4829	Sd Funk St13
D#0	6175	Crash2 St
E0	6293	Splash1 St
F0	5883	Tom Low St
F#0	5515	HH Closed 1-4St
G0	5883	Tom Low St
G#0	5538	HH Pedal 3 St
A0	5879	Tom Mid St
A#0	5553	HH Open 2St
B0	5875	Tom Hi St
C1	2922	Conga1 Hi Tip
C#1	2923	Conga1 Hi Heel
D1	2971	Tumba Slap
D#1	3217	Claves1
E1	2970	Tumba Open
F1	2922	Conga1 Hi Tip
F#1	2923	Conga1 Hi Heel
G1	2928	Conga1 Hi Slap Open
G#1	2906	Handbell L
A1	2926	Conga1 Hi Open 2
A#1	2907	Handbell H
B1	3234	Mambo Bell1
C2	2922	Conga1 Hi Tip
C#2	2923	Conga1 Hi Heel
D2	2967	Quinto1 Slap
D#2	3238	ChaCha Bell
E2	2966	Quinto1 Open
F2	2992	Bongo1 Lo 3Fingr 1-2
F#2	2979	Bongo1 Hi 1Fingr 1-2
G2	2982	Bongo1 Hi 3Fingr 1-2
G#2	3031	Timbale1 Lo 1
A2	3035	Timbale1 Paila L
A#2	3027	Timbale1 Hi 1
B2	3034	Timbale1 Paila H
C3	2872	Wood Block
C#3	2872	Wood Block
D3	3440	Shekere Down
D#3	3441	Shekere Up
E3	3442	Shekere Slap
F3	3059	Maracas1 Slur
F#3	3060	Maracas1 Staccato
G3	3112	Guiro1 Long
G#3	3114	Guiro1 Swp
A3	3113	Guiro1 Short
A#3	3125	Surdo1 Mute
B3	3124	Surdo1 Open
C4	3088	Pandeiro1 Tip
C#4	3089	Pandeiro1 Heel
D4	3087	Pandeiro1 Thump
D#4	3086	Pandeiro1 Open
E4	3103	Tmbourim Finger
F4	3102	Tmbourim Open
F#4	3104	Tmbourim Mute
G4	3107	Agogo1 Lo1 Tap
G#4	3106	Agogo1 Lo
A4	3105	Agogo1 Hi
A#4	2883	Triangle1 Open
B4	2884	Triangle1 Mute
C5	2818	ShakerA 2
C#5	2817	ShakerA 1
D5	2819	ShakerA 3
D#5	3063	Cabasa1A 1
E5	3064	Cabasa1A 2
F5	3074	Caxixi 1
F#5	3075	Caxixi 2
G5	2974	Cuica1 Lo
G#5	2975	Cuica1 Hi
A5	3220	Whistle
A#5	3220	Whistle
B5	2879	Vibraslap1
C6	2912	Wind Chime 1

Guitar/Bass FX Kit

Note	Wave Number	Wave Name
C0	2789	Acoustic Bass FX06
C#0	2789	Acoustic Bass FX06
D0	782	Play FX Mix
D#0	781	Power Chord Mono
E0	781	Power Chord Mono
F0	2784	Acoustic Bass FX01
F#0	2657	AcousticGtr FX02 St
G0	2797	Electric Bass FX 05
G#0	2808	Electric Bass FX 16
A0	2793	Electric Bass FX 01
A#0	2758	ElectricGtr FX06
B0	2809	Electric Bass FX 17
C1	2796	Electric Bass FX 04
C#1	2802	Electric Bass FX 10
D1	782	Play FX Mix
D#1	2803	Electric Bass FX 11
E1	782	Play FX Mix
F1	2810	Electric Bass FX 18
F#1	2808	Electric Bass FX 16
G1	2810	Electric Bass FX 18
G#1	2809	Electric Bass FX 17
A1	2810	Electric Bass FX 18
A#1	2765	ElectricGtr FX13
B1	2810	Electric Bass FX 18
C2	2810	Electric Bass FX 18
C#2	2738	AcousticGtr FX29 St
D2	2810	Electric Bass FX 18
D#2	2803	Electric Bass FX 11
E2	2738	AcousticGtr FX29 St
F2	2803	Electric Bass FX 11
F#2	2802	Electric Bass FX 10
G2	2738	AcousticGtr FX29 St
G#2	782	Play FX Mix
A2	2738	AcousticGtr FX29 St
A#2	2805	Electric Bass FX 13
B2	2803	Electric Bass FX 11
C3	2802	Electric Bass FX 10
C#3	2802	Electric Bass FX 10
D3	2794	Electric Bass FX 02
D#3	2800	Electric Bass FX 08
E3	2810	Electric Bass FX 18
F3	2792	Acoustic Bass FX09
F#3	2792	Acoustic Bass FX09
G3	2790	Acoustic Bass FX07
G#3	2790	Acoustic Bass FX07
A3	2789	Acoustic Bass FX06
A#3	2792	Acoustic Bass FX09
B3	782	Play FX Mix
C4	782	Play FX Mix
C#4	2814	Electric Bass FX 22
D4	2669	AcousticGtr FX06 St
D#4	2808	Electric Bass FX 16
E4	2808	Electric Bass FX 16
F4	2795	Electric Bass FX 03
F#4	782	Play FX Mix
G4	782	Play FX Mix
G#4	2803	Electric Bass FX 11
A4	2809	Electric Bass FX 17
A#4	2657	AcousticGtr FX02 St
B4	2806	Electric Bass FX 14
C5	2773	ElectricGtr FX21
C#5	2772	ElectricGtr FX20
D5	2771	ElectricGtr FX19
D#5	782	Play FX Mix
E5	782	Play FX Mix
F5	782	Play FX Mix
F#5	782	Play FX Mix
G5	887	Electric Bass FX
G#5	2814	Electric Bass FX 22
A5	2797	Electric Bass FX 05
A#5	2807	Electric Bass FX 15
B5	887	Electric Bass FX
C6	2811	Electric Bass FX 19

Wacko Kit

Note	Wave Number	Wave Name
C0	2793	Electric Bass FX 01
C#0	2496	Zap2
D0	5802	HH Pedal D&B
D#0	2890	Hand Clap1 L
E0	2640	Scratch Vo F
F0	2493	Indus Tom
F#0	5436	Sd Wood
G0	2493	Indus Tom
G#0	5426	Sd Clap Analog
A0	2493	Indus Tom
A#0	5432	Sd FM Rim
B0	4557	Bd FX Gate
C1	4626	Bd FxHammer
C#1	2928	Conga1 Hi Slap Open
D1	5431	Sd FM
D#1	2890	Hand Clap1 L
E1	5435	Sd Timbr
F1	6132	Tom Syn2
F#1	5812	HH Closed Syn
G1	6132	Tom Syn2
G#1	5813	HH Open Syn
A1	6132	Tom Syn2
A#1	5813	HH Open Syn
B1	6132	Tom Syn2
C2	6132	Tom Syn2
C#2	5612	HH Open Mono
D2	2332	Sonar1
D#2	5781	HH Open T8-1
E2	5612	HH Open Mono
F2	6277	Ride Cup2 L
F#2	2908	Sleigh Bell1
G2	5783	HH Open T8-2
G#2	2390	Resonance X-Fade
A2	6176	Crash2 L
A#2	2628	RainLoop
B2	6278	Ride Cup2 R
C3	2326	AirHose L
C#3	2326	AirHose L
D3	3525	Udu High
D#3	2238	Mg Bass2
E3	2240	Mg Bass3
F3	2789	Acoustic Bass FX06
F#3	2789	Acoustic Bass FX06
G3	3106	Agogo1 Lo
G#3	3106	Agogo1 Lo
A3	5816	HH Open Human
A#3	2514	Vox Hit Rev
B3	2512	Hi Q1
C4	2512	Hi Q1
C#4	2446	LFO Seq
D4	2446	LFO Seq
D#4	2319	BellAir
E4	2374	HH Hit
F4	2374	HH Hit
F#4	2329	Ooh Feedback
G4	2329	Ooh Feedback
G#4	2331	Mind Bell
A4	2490	Glass
A#4	2615	Swarm
B4	2613	FxGun2
C5	2387	Lektronica
C#5	782	Play FX Mix
D5	2626	Gunshot
D#5	2617	Police
E5	2489	Ripper
F5	782	Play FX Mix
F#5	2611	Tape Rewind
G5	2612	FxGun1
G#5	2610	Bomb
A5	2496	Zap2
A#5	2494	Noise Burst
B5	2378	Stab Giant
C6	2377	Stab Orchestra

Wood Bits Kit

Note	Wave Number	Wave Name
C0	4276	Claves T8-1
C#0	5194	Sd Hip Stick6 L
D0	3112	Guiro1 Long
D#0	5195	Sd Hip Stick6 R
E0	3112	Guiro1 Long
F0	2690	AcousticGtr FX13 St
F#0	2860	Castanet1
G0	2803	Electric Bass FX 11
G#0	2855	Stick1
A0	2800	Electric Bass FX 08
A#0	2799	Electric Bass FX 07
B0	6106	Tom T9 Hi
C1	2809	Electric Bass FX 17
C#1	5202	Sd Closed Rim3
D1	2856	Stick2
D#1	3112	Guiro1 Long
E1	2856	Stick2
F1	3124	Surdo1 Open
F#1	5392	Sd AnSm Rim
G1	3124	Surdo1 Open
G#1	4187	Clap AnSm
A1	3124	Surdo1 Open
A#1	2879	Vibraslap1
B1	3124	Surdo1 Open
C2	3124	Surdo1 Open
C#2	2621	Seashore
D2	3124	Surdo1 Open
D#2	5185	Sd Rock Stick2 St
E2	2627	Applause
F2	5183	Sd Rock Stick1 L
F#2	2844	Tambourine1 Shake
G2	2621	Seashore
G#2	2872	Wood Block
A2	2627	Applause
A#2	2620	Helicopter
B2	5187	Sd Rock Stick2 R
C3	2928	Conga1 Hi Slap Open
C#3	2928	Conga1 Hi Slap Open
D3	2860	Castanet1
D#3	2860	Castanet1
E3	2872	Wood Block
F3	3035	Timbale1 Paila L
F#3	3035	Timbale1 Paila L
G3	2855	Stick1
G#3	2856	Stick2
A3	3073	Caxixi 1-2
A#3	3075	Caxixi 2
B3	2618	Door Squeak
C4	2618	Door Squeak
C#4	3113	Guiro1 Short
D4	3112	Guiro1 Long
D#4	3217	Claves1
E4	2872	Wood Block
F4	2872	Wood Block
F#4	2618	Door Squeak
G4	2618	Door Squeak
G#4	2872	Wood Block
A4	3217	Claves1
A#4	2618	Door Squeak
B4	2890	Hand Clap1 L
C5	3238	ChaCha Bell
C#5	4947	Sd Rock Open2 St
D5	4599	Bd Jungle3
D#5	2967	Quinto1 Slap
E5	4439	Bd Room2
F5	4418	Bd H.Son St
F#5	5180	Sd Heavy
G5	3124	Surdo1 Open
G#5	5182	Sd Rock Stick1 St
A5	4636	Bd Slimy
A#5	5175	Sd Gate1
B5	4424	Bd Funk Son St
C6	4556	Bd Gate

Metal Bits Kit

Note	Wave Number	Wave Name
C0	4242	Cowbell T8
C#0	5529	HH Closed 4R
D0	6278	Ride Cup2 R
D#0	5813	HH Open Syn
E0	6277	Ride Cup2 L
F0	6253	Ride Cup1 St
F#0	2145	FM Metal2
G0	6225	Ride1 St
G#0	2503	Electric Perc7
A0	3224	Cowbell2
A#0	5516	HH Closed 1St
B0	3238	ChaCha Bell
C1	3224	Cowbell2
C#1	5812	HH Closed Syn
D1	5806	HH Open Tek
D#1	5782	HH Closed T8-2
E1	5794	HH Closed RX5
F1	3224	Cowbell2
F#1	5781	HH Open T8-1
G1	3224	Cowbell2
G#1	5812	HH Closed Syn
A1	3224	Cowbell2
A#1	5813	HH Open Syn
B1	3224	Cowbell2
C2	3224	Cowbell2
C#2	5815	HH Open FX
D2	3224	Cowbell2
D#2	6253	Ride Cup1 St
E2	5798	HH Open AnCR
F2	6253	Ride Cup1 St
F#2	2843	Tambourine1 Sw
G2	5815	HH Open FX
G#2	3235	Mambo Bell2
A2	5815	HH Open FX
A#2	2908	Sleigh Bell1
B2	6280	Ride Mono
C3	146	Brite Piano
C#3	146	Brite Piano
D3	423	Tubular Bell1
D#3	425	Bell
E3	428	Brass Bell
F3	3034	Timbale1 Paila H
F#3	3035	Timbale1 Paila L
G3	425	Bell
G#3	425	Bell
A3	5516	HH Closed 1St
A#3	5798	HH Open AnCR
B3	2319	BellAir
C4	2385	FX Chime
C#4	5606	HH Open Rock L
D4	2387	Lektronica
D#4	3106	Agogo1 Lo
E4	3223	Cowbell1
F4	3224	Cowbell2
F#4	2324	Hi-Lo
G4	2324	Hi-Lo
G#4	2884	Triangle1 Mute
A4	2883	Triangle1 Open
A#4	2385	FX Chime
B4	2908	Sleigh Bell1
C5	2912	Wind Chime 1
C#5	429	Small Bell
D5	429	Small Bell
D#5	428	Brass Bell
E5	432	Hibashi
F5	146	Brite Piano
F#5	5177	Sd LdwHMono
G5	146	Brite Piano
G#5	5178	Sd BreakRim
A5	439	Gamelan2
A#5	3524	Udu Finger
B5	430	Finger Cymbal
C6	425	Bell

Hands Kit

Note	Wave Number	Wave Name
C0	3290	Tabla1 Mute
C#0	5224	Sd Brush Soft St
D0	5236	Sd Brush Swir St
D#0	5227	Sd Brush Med St
E0	5239	Sd Brush SwirAtt St
F0	2738	AcousticGtr FX29 St
F#0	2856	Stick2
G0	3087	Pandeiro1 Thump
G#0	3290	Tabla1 Mute
A0	2808	Electric Bass FX 16
A#0	2702	AcousticGtr FX17 St
B0	3291	Tabla1 Combi
C1	3483	Wa Taiko
C#1	2967	Quinto1 Slap
D1	5227	Sd Brush Med St
D#1	2889	Hand Clap1 St
E1	4841	Sd Funk Ay St
F1	3526	Udu Low
F#1	3290	Tabla1 Mute
G1	3526	Udu Low
G#1	3288	Tabla1 Bya
A1	3525	Udu High
A#1	3289	Tabla1 Nah
B1	3525	Udu High
C2	3524	Udu Finger
C#2	6231	Ride2 R
D2	3524	Udu Finger
D#2	6253	Ride Cup1 St
E2	6282	Ride Cup Mono2
F2	6253	Ride Cup1 St
F#2	2845	Tambourine1 Hit
G2	6253	Ride Cup1 St
G#2	3223	Cowbell1
A2	6280	Ride Mono
A#2	2879	Vibraslap1
B2	6230	Ride2 L
C3	2979	Bongo1 Hi 1Fingr 1-2
C#3	2992	Bongo1 Lo 3Fingr 1-2
D3	2922	Conga1 Hi Tip
D#3	2928	Conga1 Hi Slap Open
E3	2926	Conga1 Hi Open 2
F3	3026	Timbale1 Hi 1-3
F#3	3030	Timbale1 Lo 1-2
G3	3105	Agogo1 Hi
G#3	3106	Agogo1 Lo
A3	3103	Tmbourim Finger
A#3	3103	Tmbourim Finger
B3	2890	Hand Clap1 L
C4	2890	Hand Clap1 L
C#4	3112	Guiro1 Long
D4	3112	Guiro1 Long
D#4	3524	Udu Finger
E4	3288	Tabla1 Bya
F4	2922	Conga1 Hi Tip
F#4	3525	Udu High
G4	3525	Udu High
G#4	3524	Udu Finger
A4	430	Finger Cymbal
A#4	3290	Tabla1 Mute
B4	2908	Sleigh Bell1
C5	2912	Wind Chime 1
C#5	2928	Conga1 Hi Slap Open
D5	2972	Tumba Tip
D#5	2972	Tumba Tip
E5	2800	Electric Bass FX 08
F5	2972	Tumba Tip
F#5	2793	Electric Bass FX 01
G5	2970	Tumba Open
G#5	2798	Electric Bass FX 06
A5	2663	AcousticGtr FX04 St
A#5	3526	Udu Low
B5	3275	Djembe1 Combi
C6	2971	Tumba Slap

Scratches

Note	Wave Number	Wave Name
C0	2629	Scratch H
C#0	2630	Scratch L
D0	2631	Scratch Down
D#0	2632	Scratch Hi F
E0	2633	Scratch Hi R
F0	2634	Scratch Lo F
F#0	2635	Scratch Lo R
G0	2636	Scratch Bd F
G#0	2637	Scratch Bd R
A0	2638	Scratch Sd F
A#0	2639	Scratch Sd R
B0	2640	Scratch Vo F
C1	2629	Scratch H
C#1	2630	Scratch L
D1	2631	Scratch Down
D#1	2632	Scratch Hi F
E1	2633	Scratch Hi R
F1	2634	Scratch Lo F
F#1	2635	Scratch Lo R
G1	2636	Scratch Bd F
G#1	2637	Scratch Bd R
A1	2638	Scratch Sd F
A#1	2639	Scratch Sd R
B1	2640	Scratch Vo F
C2	2641	Scratch Vo R
C#2	2642	Scratch Stop
D2	2643	Scratch Spin
D#2	2644	Scratch Hip
E2	2645	Scratch Hip2
F2	2648	Scratch Combi
F#2	2649	Scratch Combi2
G2	2650	Scratch Combi3
G#2	2651	Scratch Combi4
A2	2629	Scratch H
A#2	2630	Scratch L
B2	2631	Scratch Down
C3	2632	Scratch Hi F
C#3	2633	Scratch Hi R
D3	2634	Scratch Lo F
D#3	2635	Scratch Lo R
E3	2636	Scratch Bd F
F3	2637	Scratch Bd R
F#3	2638	Scratch Sd F
G3	2639	Scratch Sd R
G#3	2640	Scratch Vo F
A3	2641	Scratch Vo R
A#3	2642	Scratch Stop
B3	2643	Scratch Spin
C4	2644	Scratch Hip
C#4	2645	Scratch Hip2
D4	2648	Scratch Combi
D#4	2649	Scratch Combi2
E4	2650	Scratch Combi3
F4	2651	Scratch Combi4
F#4	2629	Scratch H
G4	2630	Scratch L
G#4	2631	Scratch Down
A4	2632	Scratch Hi F
A#4	2633	Scratch Hi R
B4	2634	Scratch Lo F
C5	2635	Scratch Lo R
C#5	2636	Scratch Bd F
D5	2637	Scratch Bd R
D#5	2638	Scratch Sd F
E5	2639	Scratch Sd R
F5	2640	Scratch Vo F
F#5	2641	Scratch Vo R
G5	2642	Scratch Stop
G#5	2643	Scratch Spin
A5	2644	Scratch Hip
A#5	2645	Scratch Hip2
B5	2648	Scratch Combi
C6	2649	Scratch Combi2

Acoustic Snares

Note	Wave Number	Wave Name
C0	4812	Sd Normal 1St
C#0	4813	Sd Normal 2St
D0	4814	Sd Normal 3St
D#0	4815	Sd Normal 4St
E0	4830	Sd Funk 1St
F0	4831	Sd Funk 2St
F#0	4832	Sd Funk 3St
G0	4841	Sd Funk Ay St
G#0	4848	Sd Basic 1St
A0	4849	Sd Basic 2St
A#0	4850	Sd Basic 3St
B0	4865	Sd SonA 1St
C1	4866	Sd SonA 2St
C#1	4867	Sd SonA 3St
D1	4868	Sd SonA 4St
D#1	4883	Sd Blues 1St
E1	4884	Sd Blues 2St
F1	4885	Sd Blues 3St
F#1	4898	Sd BluesHeart 1St
G1	4899	Sd BluesHeart 2St
G#1	4900	Sd BluesHeart 3St
A1	4915	Sd Tight 1St
A#1	4916	Sd Tight 2St
B1	4917	Sd Tight 3St
C2	4918	Sd Tight 4St
C#2	4930	Sd Hip 1St
D2	4931	Sd Hip 2St
D#2	4938	Sd Rock Open1 St
E2	4941	Sd Rock Mute1 St
F2	4944	Sd Rock Rim1 St
F#2	4947	Sd Rock Open2 St
G2	4950	Sd Rock Mute2 St
G#2	4953	Sd Rock Rim2 St
A2	4956	Sd Rock Flam St
A#2	4938	Sd Rock Open1 St
B2	4941	Sd Rock Mute1 St
C3	4944	Sd Rock Rim1 St
C#3	4947	Sd Rock Open2 St
D3	4950	Sd Rock Mute2 St
D#3	4953	Sd Rock Rim2 St
E3	4956	Sd Rock Flam St
F3	4814	Sd Normal 3St
F#3	4841	Sd Funk Ay St
G3	4850	Sd Basic 3St
G#3	4867	Sd SonA 3St
A3	4900	Sd BluesHeart 3St
A#3	4917	Sd Tight 3St
B3	4926	Sd Tight 3R
C4	4726	Sd Bid St1-4
C#4	4746	Sd Soul St1-4
D4	4766	Sd Strong St1-4
D#4	4786	Sd Rng St1-4
E4	4963	Sd Mid Rim
F4	4964	Sd Ambience
F#4	5175	Sd Gate1
G4	5177	Sd LdwHMono
G#4	5178	Sd BreakRim
A4	5179	Sd Dry
A#4	5180	Sd Heavy
B4	5181	Sd GM
C5	4986	Sd PowerB 1-5St
C#5	5010	Sd PowerC 1-5St
D5	5034	Sd PowerD 1-4St
D#5	5181	Sd GM
E5	5224	Sd Brush Soft St
F5	5227	Sd Brush Med St
F#5	5230	Sd Brush vari St
G5	5239	Sd Brush SwirAtt St
G#5	5255	Sd OrchA 1 St
A5	5263	Sd OrchB 1-2 St
A#5	5287	Sd Orch Roll St
B5	5256	Sd OrchA 2 St
C6	5227	Sd Brush Med St

Grouped St Snares

Note	Wave Number	Wave Name
C0	4806	Sd Normal St1-4
C#0	4807	Sd Normal St1-3
D0	4808	Sd Normal St2-4
D#0	4809	Sd Normal St1-2
E0	4810	Sd Normal St2-3
F0	4811	Sd Normal St3-4
F#0	4812	Sd Normal 1St
G0	4813	Sd Normal 2St
G#0	4814	Sd Normal 3St
A0	4815	Sd Normal 4St
A#0	4826	Sd Funk St1-3
B0	4827	Sd Funk St1-2
C1	4828	Sd Funk St2-3
C#1	4829	Sd Funk St13
D1	4830	Sd Funk 1St
D#1	4831	Sd Funk 2St
E1	4832	Sd Funk 3St
F1	4841	Sd Funk Ay St
F#1	4844	Sd Basic St1-3
G1	4845	Sd Basic St1-2
G#1	4846	Sd Basic St2-3
A1	4847	Sd Basic St13
A#1	4848	Sd Basic 1St
B1	4849	Sd Basic 2St
C2	4850	Sd Basic 3St
C#2	4859	Sd SonA St1-4
D2	4860	Sd SonA St1-3
D#2	4861	Sd SonA St2-4
E2	4862	Sd SonA St1-2
F2	4863	Sd SonA St2-3
F#2	4864	Sd SonA St3-4
G2	4865	Sd SonA 1St
G#2	4866	Sd SonA 2St
A2	4867	Sd SonA 3St
A#2	4868	Sd SonA 4St
B2	4879	Sd Blues St1-3
C3	4880	Sd Blues St1-2
C#3	4881	Sd Blues St2-3
D3	4882	Sd Blues St13
D#3	4883	Sd Blues 1St
E3	4884	Sd Blues 2St
F3	4885	Sd Blues 3St
F#3	4894	Sd BluesHeart St1-3
G3	4895	Sd BluesHeart St1-2
G#3	4896	Sd BluesHeart St2-3
A3	4897	Sd BluesHeart St13
A#3	4898	Sd BluesHeart 1St
B3	4899	Sd BluesHeart 2St
C4	4900	Sd BluesHeart 3St
C#4	4909	Sd Tight St1-4
D4	4910	Sd Tight St1-3
D#4	4911	Sd Tight St2-4
E4	4912	Sd Tight St1-2
F4	4913	Sd Tight St2-3
F#4	4914	Sd Tight St3-4
G4	4915	Sd Tight 1St
G#4	4916	Sd Tight 2St
A4	4917	Sd Tight 3St
A#4	4918	Sd Tight 4St
B4	4971	Sd PowerA 1St
C5	4974	Sd PowerA 2St
C#5	4977	Sd PowerA 3St
D5	4980	Sd PowerA 4St
D#5	4983	Sd PowerA 5St
E5	4992	Sd PowerB 1St
F5	4995	Sd PowerB 2St
F#5	4998	Sd PowerB 3St
G5	5001	Sd PowerB 4St
G#5	5004	Sd PowerB 5St
A5	5010	Sd PowerC 1-5St
A#5	5034	Sd PowerD 1-4St
B5	4879	Sd Blues St1-3
C6	4894	Sd BluesHeart St1-3

All Kicks

Note	Wave Number	Wave Name
C0	4394	Bd Normal St1-2
C#0	4367	Bd Snap 1-2
D0	4377	Bd Tight 1
D#0	4397	Bd Normal L1-2
E0	4403	Bd Funk St1-2
F0	4385	Bd Ambience 1-2
F#0	4405	Bd Funk 2St
G0	4412	Bd High St
G#0	4415	Bd Low St
A0	4418	Bd H Son St
A#0	4421	Bd L Son St
B0	4424	Bd Funk Son St
C1	4427	Bd Rock1 St
C#1	4430	Bd Rock2 St
D1	4433	Bd Dry1
D#1	4434	Bd Dry2
E1	4435	Bd Pop
F1	4436	Bd Var1
F#1	4437	Bd Var2
G1	4438	Bd Room1
G#1	4439	Bd Room2
A1	4440	Bd Room3
A#1	4556	Bd Gate
B1	4557	Bd FX Gate
C2	4454	Bd PowerA 1-2St
C#2	4463	Bd PowerB 1-2St
D2	4450	Bd FK Jazz St
D#2	4563	Bd T9-4
E2	4564	Bd T9 Hd1
F2	4565	Bd T9 Hd2
F#2	4566	Bd T9 Hd3
G2	4580	Bd T8-1
G#2	4581	Bd T8-2
A2	4582	Bd T8-3
A#2	4590	Bd AnSm
B2	4591	Bd AnCR
C3	4593	Bd Human1
C#3	4594	Bd Human2
D3	4595	Bd Brip
D#3	4596	Bd BlpHd
E3	4597	Bd Jungle1
F3	4598	Bd Jungle2
F#3	4599	Bd Jungle3
G3	4600	Bd D&B1
G#3	4601	Bd D&B2
A3	4602	Bd R&B1
A#3	4603	Bd R&B2
B3	4604	Bd Hip Deep
C4	4605	Bd Break Deep
C#4	4606	Bd Break1
D4	4607	Bd Break2
D#4	4608	Bd Break Heavy
E4	4609	Bd Break Hard
F4	4610	Bd Distortion1
F#4	4611	Bd Distortion2
G4	4612	Bd Distortion3
G#4	4613	Bd Distortion4
A4	4614	Bd Distortion5
A#4	4615	Bd Distortion RM
B4	4616	Bd +HH
C5	4626	Bd FxHammer
C#5	4627	Bd ZapHard
D5	4628	Bd ZapMid
D#5	4629	Bd Sustain
E5	4630	Bd TekPower
F5	4631	Bd Hard Long
F#5	4632	Bd Analog Tight
G5	4633	Bd Analog Hard
G#5	4634	Bd Lo-Fi
A5	4635	Bd ThickSkin
A#5	4636	Bd Slimy
B5	4715	Bd HipHop8
C6	4717	Bd HipHop10

Dance Kicks

Note	Wave Number	Wave Name
C0	4560	Bd T9-1
C#0	4560	Bd T9-1
D0	4561	Bd T9-2
D#0	4562	Bd T9-3
E0	4562	Bd T9-3
F0	4563	Bd T9-4
F#0	4564	Bd T9 Hd1
G0	4565	Bd T9 Hd2
G#0	4566	Bd T9 Hd3
A0	4566	Bd T9 Hd3
A#0	4631	Bd Hard Long
B0	4591	Bd AnCR
C1	4560	Bd T9-1
C#1	4561	Bd T9-2
D1	4562	Bd T9-3
D#1	4563	Bd T9-4
E1	4564	Bd T9 Hd1
F1	4565	Bd T9 Hd2
F#1	4566	Bd T9 Hd3
G1	4580	Bd T8-1
G#1	4581	Bd T8-2
A1	4582	Bd T8-3
A#1	4637	Bd Elec1
B1	4591	Bd AnCR
C2	4593	Bd Human1
C#2	4637	Bd Elec1
D2	4595	Bd Brip
D#2	4596	Bd BlpHd
E2	4639	Bd Elec3
F2	4644	Bd ElecFX1
F#2	4645	Bd ElecFX2
G2	4646	Bd ElecGate
G#2	4647	Bd ElecClick
A2	4648	Bd ElecPower1
A#2	4603	Bd R&B2
B2	4604	Bd Hip Deep
C3	4605	Bd Break Deep
C#3	4606	Bd Break1
D3	4649	Bd ElecPower2
D#3	4608	Bd Break Heavy
E3	4609	Bd Break Hard
F3	4610	Bd Distortion1
F#3	4611	Bd Distortion2
G3	4612	Bd Distortion3
G#3	4613	Bd Distortion4
A3	4614	Bd Distortion5
A#3	4638	Bd Elec2
B3	4641	Bd ElecComp1
C4	4626	Bd FxHammer
C#4	4627	Bd ZapHard
D4	4628	Bd ZapMid
D#4	4629	Bd Sustain
E4	4630	Bd TekPower
F4	4631	Bd Hard Long
F#4	4632	Bd Analog Tight
G4	4633	Bd Analog Hard
G#4	4642	Bd ElecComp2
A4	4643	Bd ElecComp3
A#4	4636	Bd Slimy
B4	4556	Bd Gate
C5	4557	Bd FX Gate
C#5	4708	Bd HipHop1
D5	4709	Bd HipHop2
D#5	4710	Bd HipHop3
E5	4711	Bd HipHop4
F5	4712	Bd HipHop5
F#5	4713	Bd HipHop6
G5	4714	Bd HipHop7
G#5	4715	Bd HipHop8
A5	4716	Bd HipHop9
A#5	4717	Bd HipHop10
B5	4631	Bd Hard Long
C6	4632	Bd Analog Tight

Arabic Mixed Kit 1

Note	Wave Number	Wave Name
C0	2912	Wind Chime 1
C#0	5224	Sd Brush Soft St
D0	5236	Sd Brush Swir St
D#0	5227	Sd Brush Med St
E0	5239	Sd Brush SwirAtt St
F0	5212	Sd LiveRoll St
F#0	2860	Castanet1
G0	4812	Sd Normal 1St
G#0	2855	Stick1
A0	4561	Bd T9-2
A#0	4844	Sd Basic St1-3
B0	4412	Bd High St
C1	4394	Bd Normal St1-2
C#1	4826	Sd Funk St1-3
D1	4726	Sd Bld St1-4
D#1	2889	Hand Clap1 St
E1	4746	Sd Soul St1-4
F1	5899	Tom Rock Low St
F#1	5515	HH Closed 1-4St
G1	5895	Tom Rock Mid St
G#1	5535	HH Pedal 1-3St
A1	5887	Tom Floor St
A#1	5551	HH Open 1-2St
B1	5883	Tom Low St
C2	5879	Tom Mid St
C#2	6175	Crash2 St
D2	5875	Tom Hi St
D#2	5551	HH Open 1-2St
E2	6346	Reverse Cymbal1
F2	3030	Timbale1 Lo 1-2
F#2	2926	Conga1 Hi Open 2
G2	3026	Timbale1 Hi 1-3
G#2	2928	Conga1 Hi Slap Open
A2	2843	Tambourine1 Sw
A#2	2970	Tumba Open
B2	3223	Cowbell1
C3	3217	Claves1
C#3	2979	Bongo1 Hi 1Fingr 1-2
D3	2872	Wood Block
D#3	2992	Bongo1 Lo 3Fingr 1-2
E3	2872	Wood Block
F3	3351	Dohol Low
F#3	3062	Cabasa1A 1-2
G3	3352	Dohol High
G#3	2817	ShakerA 1
A3	2860	Castanet1
A#3	3058	Maracas1 Sw
B3	2860	Castanet1
C4	3567	Twaisat3
C#4	3565	Twaisat1
D4	3566	Twaisat2
D#4	3568	Twaisat4
E4	3568	Twaisat4
F4	3509	Small Tabla Dom
F#4	3543	Barasim Dom
G4	3510	Small Tabla Snap
G#4	3544	Barasim Sak
A4	3511	Small Tabla Sak
A#4	3545	Barasim Tak
B4	3512	Small Tabla Tak
C5	3513	Big Tabla Dom
C#5	3563	Segal Dom
D5	3514	Big Tabla Tak
D#5	3564	Segal Tak
E5	3515	Big Tabla Sak
F5	3516	Tabla Dom
F#5	3517	Tabla Tak1
G5	3523	Tabla Tremolo
G#5	3518	Tabla Tak2
A5	3519	Tabla Tik1
A#5	3522	Tabla Sak1
B5	3521	Tabla Tik3
C6	3520	Tabla Tik2

Belly Dance Kit

Note	Wave Number	Wave Name
C0	3520	Tabla Tik2
C#0	3483	Wa Taiko
D0	3272	Djembe1 Edge
D#0	3273	Djembe1 Mute
E0	3274	Djembe1 Open
F0	3275	Djembe1 Combi
F#0	3288	Tabla1 Bya
G0	3289	Tabla1 Nah
G#0	3290	Tabla1 Mute
A0	3291	Tabla1 Combi
A#0	3509	Small Tabla Dom
B0	3509	Small Tabla Dom
C1	4631	Bd Hard Long
C#1	4560	Bd T9-1
D1	5350	Sd T9-2
D#1	4188	Electric Clap1
E1	4776	Sd Strong L1-4
F1	6135	Tom Dist Lo
F#1	5766	HH Closed T9
G1	6134	Tom Dist Hi
G#1	5780	HH Closed T8-1
A1	6131	Tom Syn1
A#1	5767	HH Open T9
B1	6132	Tom Syn2
C2	5408	Sd Hip1
C#2	6180	Crash4
D2	5404	Sd D&B4
D#2	5799	HH Closed Break
E2	6346	Reverse Cymbal1
F2	3030	Timbale1 Lo 1-2
F#2	2926	Conga1 Hi Open 2
G2	3026	Timbale1 Hi 1-3
G#2	2928	Conga1 Hi Slap Open
A2	2843	Tambourine1 Sw
A#2	2970	Tumba Open
B2	3223	Cowbell1
C3	3217	Claves1
C#3	2979	Bongo1 Hi 1Fingr 1-2
D3	2872	Wood Block
D#3	2992	Bongo1 Lo 3Fingr 1-2
E3	2872	Wood Block
F3	3351	Dohol Low
F#3	3062	Cabasa1A 1-2
G3	3352	Dohol High
G#3	2817	ShakerA 1
A3	2860	Castanet1
A#3	3058	Maracas1 Sw
B3	2860	Castanet1
C4	3567	Twaisat3
C#4	3565	Twaisat1
D4	3566	Twaisat2
D#4	3568	Twaisat4
E4	3568	Twaisat4
F4	3509	Small Tabla Dom
F#4	3543	Barasim Dom
G4	3510	Small Tabla Snap
G#4	3544	Barasim Sak
A4	3511	Small Tabla Sak
A#4	3545	Barasim Tak
B4	3512	Small Tabla Tak
C5	3513	Big Tabla Dom
C#5	3563	Segal Dom
D5	3514	Big Tabla Tak
D#5	3564	Segal Tak
E5	3515	Big Tabla Sak
F5	3516	Tabla Dom
F#5	3517	Tabla Tak1
G5	3523	Tabla Tremolo
G#5	3518	Tabla Tak2
A5	3519	Tabla Tik1
A#5	3522	Tabla Sak1
B5	3521	Tabla Tik3
C6	3520	Tabla Tik2

Dance Snares

Note	Wave Number	Wave Name
C0	5422	Sd FX1
C#0	5423	Sd FX2
D0	5424	Sd FX3
D#0	5425	Sd FX4
E0	5427	Sd Dist
F0	5428	Sd Cut
F#0	5429	Sd Garg H
G0	5430	Sd Garg L
G#0	5431	Sd FM
A0	5433	Sd Syn
A#0	5437	Sd Hammer
B0	5438	Sd Lo-Fi
C1	5349	Sd T9-1
C#1	5350	Sd T9-2
D1	5351	Sd T9-3
D#1	5352	Sd T9-4
E1	5353	Sd T9-5
F1	5354	Sd T9Gate
F#1	5376	Sd T8-1
G1	5377	Sd T8-2
G#1	5378	Sd T8-3
A1	5379	Sd T8-4
A#1	5380	Sd T8-5
B1	5391	Sd AnSm
C2	5393	Sd AnCR
C#2	5395	Sd Human1
D2	5397	Sd Jungle1
D#2	5398	Sd Jungle2
E2	5399	Sd Jungle3
F2	5400	Sd JungleFX
F#2	5401	Sd D&B1
G2	5402	Sd D&B2
G#2	5403	Sd D&B3
A2	5404	Sd D&B4
A#2	5405	Sd R&B1
B2	5406	Sd R&B1 Rim
C3	5407	Sd R&B2
C#3	5408	Sd Hip1
D3	5409	Sd Hip2
D#3	5410	Sd Hip3
E3	5411	Sd Hip Gate
F3	5412	Sd Hip Rim1
F#3	5413	Sd Hip Rim2
G3	5414	Sd Hip Rim3
G#3	5415	Sd Hip Rim4
A3	5416	Sd Hip Rim5
A#3	5418	Sd Break2
B3	5420	Sd Break Heavy
C4	5316	Sd Elec1
C#4	5317	Sd Elec2
D4	5318	Sd Elec3
D#4	5319	Sd Elec4
E4	5320	Sd Elec5
F4	5321	Sd Elec6
F#4	5322	Sd Elec7
G4	5323	Sd Elec8
G#4	5324	Sd Elec9
A4	5325	Sd Elec10
A#4	5326	Sd Elec11
B4	5327	Sd Elec12
C5	5316	Sd Elec1
C#5	5377	Sd T8-2
D5	5318	Sd Elec3
D#5	5319	Sd Elec4
E5	5320	Sd Elec5
F5	5321	Sd Elec6
F#5	5322	Sd Elec7
G5	5316	Sd Elec1
G#5	5323	Sd Elec8
A5	5325	Sd Elec10
A#5	5326	Sd Elec11
B5	5327	Sd Elec12
C6	5351	Sd T9-3

Special SFXs

Note	Wave Number	Wave Name
C0	2277	Mini Brip2
C#0	2276	Mini Brip1
D0	2278	Mini Brip3
D#0	2279	Mini Brip4
E0	2280	Mini Brip5
F0	2281	Mini Brip6
F#0	2491	Bell FX1
G0	2492	Bell FX2
G#0	2500	Electric Perc4
A0	2502	Electric Perc6
A#0	2511	Electric Perc15
B0	2501	Electric Perc5
C1	2498	Electric Perc2
C#1	2499	Electric Perc3
D1	2503	Electric Perc7
D#1	2504	Electric Perc8
E1	2505	Electric Perc9
F1	2506	Electric Perc10
F#1	2510	Electric Perc14
G1	2509	Electric Perc13
G#1	2397	Neo Seq Em-3
A1	2206	Spectrum1
A#1	2208	Spectrum3
B1	2207	Spectrum2
C2	2403	Whisper Seq Bb
C#2	2480	Digi Voice Mod
D2	2338	Moving Chime St
D#2	2335	Engine Room St
E2	2447	Raspberry
F2	2448	Digi Heli
F#2	2397	Hop FX1
G2	2302	Willow St
G#2	2310	Anemone St
A2	2313	Magnitude St
A#2	2445	Radio Noise
B2	2391	Quiek
C3	2378	Stab Giant
C#3	2374	HH Hit
D3	2379	Stab Hard
D#3	2380	Stab Organ2
E3	2381	Stab Aah
F3	2382	Hit Uhh
F#3	2383	Hit Orchestra2
G3	2375	Hit Orchestra1
G#3	2376	Hit Brass
A3	2366	Orchestra Hit1 St
A#3	2369	Orchestra Hit2 St
B3	1369	Brass Sect Fall
C4	782	Play FX Mix
C#4	782	Play FX Mix
D4	2775	ElectricGtr FX23
D#4	2787	Acoustic Bass FX04
E4	2788	Acoustic Bass FX05
F4	2784	Acoustic Bass FX01
F#4	2629	Scratch H
G4	2630	Scratch L
G#4	2631	Scratch Down
A4	2632	Scratch Hi F
A#4	2642	Scratch Stop
B4	2611	Tape Rewind
C5	2489	Ripper
C#5	2494	Noise Burst
D5	2495	Zap1
D#5	2496	Zap2
E5	2512	Hi Q1
F5	2513	Hi Q2
F#5	2610	Bomb
G5	2612	FxGun1
G#5	2341	Motion Beam
A5	2304	Birch St
A#5	2138	Tri Wave
B5	2259	FM Bass2
C6	2145	FM Metal2

Synthetic Kit

Note	Wave Number	Wave Name
C0	4638	Bd Elec2
C#0	2642	Scratch Stop
D0	5237	Sd Brush Swir L
D#0	5229	Sd Brush Med R
E0	5236	Sd Brush Swir St
F0	5215	Sd Roll Mono
F#0	2263	FM Bass6
G0	2621	Seashore
G#0	2500	Electric Perc4
A0	4643	Bd ElecComp3
A#0	4783	Sd Strong R2
B0	4638	Bd Elec2
C1	4636	Bd Slimy
C#1	3034	Timbale1 Paila H
D1	4959	Sd Piccolo
D#1	4187	Clap AnSm
E1	5325	Sd Elec10
F1	2238	Mg Bass2
F#1	2513	Hi Q2
G1	2238	Mg Bass2
G#1	2503	Electric Perc7
A1	6123	Tom T8
A#1	5783	HH Open T8-2
B1	6123	Tom T8
C2	6123	Tom T8
C#2	6179	Crash3
D2	6123	Tom T8
D#2	6281	Ride Cup Mono
E2	6281	Ride Cup Mono
F2	6281	Ride Cup Mono
F#2	2638	Scratch Sd F
G2	6256	Ride Cup1 RL
G#2	2503	Electric Perc7
A2	6179	Crash3
A#2	2324	Hi-Lo
B2	6287	China2
C3	2141	Ring Mod
C#3	2504	Electric Perc8
D3	2141	Ring Mod
D#3	2503	Electric Perc7
E3	2507	Electric Perc11
F3	3052	Paila H
F#3	3052	Paila H
G3	2392	Hop FX1
G#3	2393	Hop FX2
A3	2629	Scratch H
A#3	2632	Scratch Hi F
B3	2496	Zap2
C4	2446	LFO Seq
C#4	2446	LFO Seq
D4	2216	Mini Bass3a
D#4	2391	Quiek
E4	2334	Digi Breath
F4	2448	Digi Heli
F#4	2503	Electric Perc7
G4	2149	FM Organ1
G#4	3431	Tibetan Bowl
A4	3431	Tibetan Bowl
A#4	3563	Segal Dom
B4	2337	Engine Room R
C5	2504	Electric Perc8
C#5	636	Steel1 Slide St
D5	2277	Mini Brip2
D#5	2207	Spectrum2
E5	2280	Mini Brip5
F5	2282	Noise
F#5	4600	Bd D&B1
G5	2207	Spectrum2
G#5	2316	SabreTone
A5	2510	Electric Perc14
A#5	2504	Electric Perc8
B5	2448	Digi Heli
C6	2912	Wind Chime 1

SFX Kit

Note	Wave Number	Wave Name
C0	2062	Fat Saw Mn
C#0	2646	Scratch Attack
D0	2207	Spectrum2
D#0	2210	3o3 Saw2
E0	2616	TurnTable
F0	5215	Sd Roll Mono
F#0	2263	FM Bass6
G0	2611	Tape Rewind
G#0	2501	Electric Perc5
A0	4642	Bd ElecComp2
A#0	4806	Sd Normal St1-4
B0	4636	Bd Slimy
C1	4638	Bd Elec2
C#1	2216	Mini Bass3a
D1	4894	Sd BluesHeart St1-3
D#1	2211	3o3 Square
E1	4875	Sd SonA 3L
F1	6134	Tom Dist Hi
F#1	2448	Digi Heli
G1	6134	Tom Dist Hi
G#1	2498	Electric Perc2
A1	6134	Tom Dist Hi
A#1	5783	HH Open T8-2
B1	6134	Tom Dist Hi
C2	6134	Tom Dist Hi
C#2	6179	Crash3
D2	6134	Tom Dist Hi
D#2	6255	Ride Cup1 R
E2	6232	Ride2 RL
F2	6282	Ride Cup Mono2
F#2	2632	Scratch Hi F
G2	6294	Splash1 L
G#2	2212	Mini Bass1
A2	6171	Crash1 St
A#2	2335	Engine Room St
B2	6256	Ride Cup1 RL
C3	2116	Sync LFO
C#3	2117	P5 SawDown 0 dg
D3	2076	OB Strings
D#3	4807	Sd Normal St1-3
E3	2507	Electric Perc11
F3	2084	PWM Slow
F#3	2446	LFO Seq
G3	2320	BigSyn
G#3	2320	BigSyn
A3	2383	Hit Orchestra2
A#3	3509	Small Tabla Dom
B3	2160	Digi 03
C4	2160	Digi 03
C#4	2158	Digi 01
D4	2158	Digi 01
D#4	2332	Sonar1
E4	2379	Stab Hard
F4	2335	Engine Room St
F#4	2452	Chatter
G4	2458	Hoo
G#4	3429	Mondira
A4	3429	Mondira
A#4	510	Rotor
B4	2447	Raspberry
C5	2448	Digi Heli
C#5	2211	3o3 Square
D5	2393	Hop FX2
D#5	2197	DigiBell3
E5	2514	Vox Hit Rev
F5	2512	Hi Q1
F#5	2611	Tape Rewind
G5	2613	FxGun2
G#5	2612	FxGun1
A5	2614	Thunder
A#5	2617	Police
B5	2610	Bomb
C6	2610	Bomb

Stereo GM Kit

Note	Wave Number	Wave Name
C0	3217	Claves1
C#0	5224	Sd Brush Soft St
D0	5236	Sd Brush Swir St
D#0	5227	Sd Brush Med St
E0	5239	Sd Brush SwirAtt St
F0	5212	Sd LiveRoll St
F#0	2860	Castanet1
G0	4812	Sd Normal 1St
G#0	2855	Stick1
A0	4403	Bd Funk St1-2
A#0	4846	Sd Basic St2-3
B0	4412	Bd High St
C1	4394	Bd Normal St1-2
C#1	5198	Sd Closed Rim St
D1	4806	Sd Normal St1-4
D#1	4179	Clap T9-1
E1	4845	Sd Basic St1-2
F1	5887	Tom Floor St
F#1	5515	HH Closed 1-4St
G1	5883	Tom Low St
G#1	5538	HH Pedal 3 St
A1	5883	Tom Low St
A#1	5553	HH Open 2St
B1	5879	Tom Mid St
C2	5879	Tom Mid St
C#2	6175	Crash2 St
D2	5875	Tom Hi St
D#2	6225	Ride1 St
E2	6283	China1 St
F2	6253	Ride Cup1 St
F#2	2843	Tambourine1 Sw
G2	6293	Splash1 St
G#2	3224	Cowbell2
A2	6178	Crash2 RL
A#2	2879	Vibraslap1
B2	6228	Ride1 RL
C3	2979	Bongo1 Hi 1Fingr 1-2
C#3	2992	Bongo1 Lo 3Fingr 1-2
D3	2922	Conga1 Hi Tip
D#3	2926	Conga1 Hi Open 2
E3	2970	Tumba Open
F3	3026	Timbale1 Hi 1-3
F#3	3030	Timbale1 Lo 1-2
G3	3105	Agogo1 Hi
G#3	3106	Agogo1 Lo
A3	3062	Cabasa1A 1-2
A#3	3059	Maracas1 Slur
B3	3220	Whistle
C4	3220	Whistle
C#4	3113	Guiro1 Short
D4	3112	Guiro1 Long
D#4	3217	Claves1
E4	2872	Wood Block
F4	2872	Wood Block
F#4	2975	Cuica1 Hi
G4	2974	Cuica1 Lo
G#4	2884	Triangle1 Mute
A4	2883	Triangle1 Open
A#4	2817	ShakerA 1
B4	2908	Sleigh Bell1
C5	2912	Wind Chime 1
C#5	4886	Sd Blues L1-3
D5	4909	Sd Tight St1-4
D#5	4902	Sd BluesHeart R1-3
E5	4929	Sd Hip St1-2
F5	4415	Bd Low St
F#5	5177	Sd LdwHMMono
G5	4602	Bd R&B1
G#5	5180	Sd Heavy
A5	4438	Bd Room1
A#5	4964	Sd Ambience
B5	4424	Bd Funk Son St
C6	4439	Bd Room2

Maple Custom Kit

Note	Wave Number	Wave Name
C0	3224	Cowbell2
C#0	5224	Sd Brush Soft St
D0	5236	Sd Brush Swir St
D#0	5227	Sd Brush Med St
E0	5239	Sd Brush SwirAtt St
F0	5142	Sd Metal SnRoll St
F#0	2860	Castanet1
G0	5082	Sd Beech 1-4 St
G#0	2856	Stick2
A0	4490	Bd Oak Open 1-2 St
A#0	5100	Sd Beech OpRm 1-2 St
B0	4472	Bd Maple Close 1-2St
C1	4481	Bd Maple Open 1-2 St
C#1	5139	Sd Metal ClRm St
D1	5112	Sd Metal 1-4 St
D#1	2889	Hand Clap1 St
E1	5130	Sd Metal OpRm 1-2 St
F1	5975	Tom Maple Flr 1-2 St
F#1	5662	HH Dark Closed 1-4St
G1	5975	Tom Maple Flr 1-2 St
G#1	5682	HH Dark Pedal 1-2 St
A1	5963	Tom Maple Mid 1-2 St
A#1	5694	HH Dark Open 1-2 St
B1	5951	Tom Maple Hi 1-2 St
C2	5951	Tom Maple Hi 1-2 St
C#2	6181	Crash Brite St
D2	5951	Tom Maple Hi 1-2 St
D#2	6233	Ride Brite St
E2	6288	China3 St
F2	6237	Ride Brite Cup St
F#2	2846	Tambourine2 Sw
G2	6297	Splash2 St
G#2	3225	Cowbell3 Sw
A2	6185	Crash Dark St
A#2	2880	Vibraslap2
B2	6241	Ride Warm St
C3	3000	Bongo2 Hi Open 2
C#3	3004	Bongo2 Lo Open 2
D3	2944	Conga2 Hi Slap 2
D#3	2947	Conga2 Hi Open 2
E3	2950	Conga2 Lo Open 1
F3	3026	Timbale1 Hi 1-3
F#3	3030	Timbale1 Lo 1-2
G3	3105	Agogo1 Hi
G#3	3106	Agogo1 Lo
A3	3065	Cabasa1B 1-4
A#3	3059	Maracas1 Slur
B3	3220	Whistle
C4	3220	Whistle
C#4	3118	MetalGuiro Short 1-2
D4	3121	MetalGuiro Long
D#4	3218	Claves2
E4	2914	Resin Block Small
F4	2915	Resin Block Large
F#4	2975	Cuica1 Hi
G4	2974	Cuica1 Lo
G#4	2884	Triangle1 Mute
A4	2883	Triangle1 Open
A#4	2820	ShakerB Sw
B4	2909	Sleigh Bell2
C5	2910	Ghunghuru
C#5	3127	Surdo2 Mute
D5	3126	Surdo2 Open
D#5	2941	Conga2 Hi Tip
E5	2940	Conga2 Hi Heel
F5	2942	Conga2 Hi Slap 1-2
F#5	2948	Conga2 Hi Mute
G5	2945	Conga2 Hi Open 1-2
G#5	2952	Conga2 Lo Slide
A5	2949	Conga2 Lo Open 1-2
A#5	3278	Djembe2 Mute
B5	3276	Djembe2 Lo
C6	3277	Djembe2 Slap

Oak Custom Kit

Note	Wave Number	Wave Name
C0	3224	Cowbell2
C#0	5224	Sd Brush Soft St
D0	5236	Sd Brush Swir St
D#0	5227	Sd Brush Med St
E0	5239	Sd Brush SwirAtt St
F0	5142	Sd Metal SnRoll St
F#0	2860	Castanet1
G0	5112	Sd Metal 1-4 St
G#0	2856	Stick2
A0	4490	Bd Oak Open 1-2 St
A#0	5130	Sd Metal OpRm 1-2 St
B0	4499	Bd Oak Close 1-2 St
C1	4490	Bd Oak Open 1-2 St
C#1	5079	Sd Oak ClRm St
D1	5052	Sd Oak 1-4 St
D#1	2889	Hand Clap1 St
E1	5070	Sd Oak OpRm 1-2 St
F1	6011	Tom Oak Floor 1-2 St
F#1	5662	HH Dark Closed 1-4St
G1	6011	Tom Oak Floor 1-2 St
G#1	5682	HH Dark Pedal 1-2 St
A1	5999	Tom Oak Mid 1-2 St
A#1	5694	HH Dark Open 1-2 St
B1	5999	Tom Oak Mid 1-2 St
C2	5987	Tom Oak Hi 1-2 St
C#2	6181	Crash Brite St
D2	5987	Tom Oak Hi 1-2 St
D#2	6233	Ride Brite St
E2	6288	China3 St
F2	6237	Ride Brite Cup St
F#2	2846	Tambourine2 Sw
G2	6297	Splash2 St
G#2	3225	Cowbell3 Sw
A2	6185	Crash Dark St
A#2	2880	Vibraslap2
B2	6241	Ride Warm St
C3	3000	Bongo2 Hi Open 2
C#3	3004	Bongo2 Lo Open 2
D3	2944	Conga2 Hi Slap 2
D#3	2947	Conga2 Hi Open 2
E3	2950	Conga2 Lo Open 1
F3	3038	Timbale2 Hi 2
F#3	3042	Timbale2 Lo 2
G3	3105	Agogo1 Hi
G#3	3106	Agogo1 Lo
A3	3065	Cabasa1B 1-4
A#3	3059	Maracas1 Slur
B3	3220	Whistle
C4	3220	Whistle
C#4	3118	MetalGuiro Short 1-2
D4	3121	MetalGuiro Long
D#4	3218	Claves2
E4	2914	Resin Block Small
F4	2915	Resin Block Large
F#4	2975	Cuica1 Hi
G4	2974	Cuica1 Lo
G#4	2884	Triangle1 Mute
A4	2883	Triangle1 Open
A#4	2820	ShakerB Sw
B4	2909	Sleigh Bell2
C5	2912	Wind Chime 1
C#5	3127	Surdo2 Mute
D5	3126	Surdo2 Open
D#5	2941	Conga2 Hi Tip
E5	2940	Conga2 Hi Heel
F5	2942	Conga2 Hi Slap 1-2
F#5	2948	Conga2 Hi Mute
G5	2945	Conga2 Hi Open 1-2
G#5	2952	Conga2 Lo Slide
A5	2949	Conga2 Lo Open 1-2
A#5	3278	Djembe2 Mute
B5	3276	Djembe2 Lo
C6	3277	Djembe2 Slap

Nu Jazzy Kit

Note	Wave Number	Wave Name
C0	3224	Cowbell2
C#0	5224	Sd Brush Soft St
D0	5236	Sd Brush Swir St
D#0	5227	Sd Brush Med St
E0	5239	Sd Brush SwirAtt St
F0	5142	Sd Metal SnRoll St
F#0	2903	Finger Snap 1
G0	5112	Sd Metal 1-4 St
G#0	2856	Stick2
A0	4490	Bd Oak Open 1-2 St
A#0	5130	Sd Metal OpRm 1-2 St
B0	4508	Bd Njz Closed 1-2 St
C1	4517	Bd Njz Open 1-2 St
C#1	5172	Sd Njz ClRm St
D1	5145	Sd Njz 1-4 St
D#1	2892	Hand Clap2 Sw
E1	5163	Sd Njz OpRm 1-2 St
F1	6047	Tom Njz Floor 1-2 St
F#1	5706	HH Njz Closed 1-4 St
G1	6047	Tom Njz Floor 1-2 St
G#1	5726	HH Njz Pedal 1-2 St
A1	6035	Tom Njz Low 1-2 St
A#1	5738	HH Njz Open 1-2 St
B1	6035	Tom Njz Low 1-2 St
C2	6023	Tom Njz Mid 1-2 St
C#2	6193	Crash NjzB St
D2	6023	Tom Njz Mid 1-2 St
D#2	6245	Ride Njz St
E2	6288	China3 St
F2	6249	Ride Njz Cup St
F#2	2846	Tambourine2 Sw
G2	6297	Splash2 St
G#2	3225	Cowbell3 Sw
A2	6189	Crash NjzA St
A#2	2880	Vibraslap2
B2	6241	Ride Warm St
C3	3000	Bongo2 Hi Open 2
C#3	3004	Bongo2 Lo Open 2
D3	2944	Conga2 Hi Slap 2
D#3	2947	Conga2 Hi Open 2
E3	2950	Conga2 Lo Open 1
F3	3026	Timbale1 Hi 1-3
F#3	3030	Timbale1 Lo 1-2
G3	3105	Agogo1 Hi
G#3	3106	Agogo1 Lo
A3	3065	Cabasa1B 1-4
A#3	3059	Maracas1 Slur
B3	3220	Whistle
C4	3220	Whistle
C#4	3118	MetalGuro Short 1-2
D4	3121	MetalGuro Long
D#4	3218	Claves2
E4	2914	Resin Block Small
F4	2915	Resin Block Large
F#4	2975	Cuica1 Hi
G4	2974	Cuica1 Lo
G#4	2884	Triangle1 Mute
A4	2883	Triangle1 Open
A#4	2820	ShakerB Sw
B4	2908	Sleigh Bell1
C5	2912	Wind Chime 1
C#5	3127	Surdo2 Mute
D5	3126	Surdo2 Open
D#5	2941	Conga2 Hi Tip
E5	2940	Conga2 Hi Heel
F5	2942	Conga2 Hi Slap 1-2
F#5	2948	Conga2 Hi Mute
G5	2945	Conga2 Hi Open 1-2
G#5	2952	Conga2 Lo Slide
A5	2949	Conga2 Lo Open 1-2
A#5	3278	Djembe2 Mute
B5	3276	Djembe2 Lo
C6	3277	Djembe2 Slap

Illest Hip Hop Kit

Note	Wave Number	Wave Name
C0	4709	Bd HipHop2
C#0	5502	Sd HipHop14
D0	5495	Sd HipHop7
D#0	4219	HipHop Clap9
E0	4718	Bd HipHop11
F0	4220	HipHop Clap10
F#0	5501	Sd HipHop13
G0	5492	Sd HipHop4
G#0	5500	Sd HipHop12
A0	4715	Bd HipHop8
A#0	5510	Sd HipHop Rim6
B0	4720	Bd HipHop13
C1	4719	Bd HipHop12
C#1	5508	Sd HipHop Rim4
D1	5499	Sd HipHop11
D#1	4223	HipHop Clap13
E1	5490	Sd HipHop2
F1	6094	Tom Dry Lo
F#1	5648	HH Power ClEGde 3R
G1	6094	Tom Dry Lo
G#1	5652	HH Power ClEGde 4R
A1	6093	Tom Dry Hi
A#1	5660	HH Power Open EdgeR
B1	6093	Tom Dry Hi
C2	6093	Tom Dry Hi
C#2	6180	Crash4
D2	6093	Tom Dry Hi
D#2	6230	Ride2 L
E2	6176	Crash2 L
F2	6280	Ride Mono
F#2	2845	Tambourine1 Hit
G2	6220	Hand Cymbal Open L
G#2	3236	Mambo Bell Body
A2	6285	China1 R
A#2	2906	Handbell L
B2	6282	Ride Cup Mono2
C3	2928	Conga1 Hi Slap Open
C#3	2936	Conga1 Lo Open 1
D3	2933	Conga1 Lo Tip
D#3	2939	Conga1 Lo Slap Open
E3	2937	Conga1 Lo Open 2
F3	4711	Bd HipHop4
F#3	4213	HipHop Clap3
G3	5805	HH Closed Tek
G#3	5805	HH Closed Tek
A3	2818	ShakerA 2
A#3	2817	ShakerA 1
B3	4717	Bd HipHop10
C4	4616	Bd +HH
C#4	5498	Sd HipHop10
D4	5503	Sd HipHop15
D#4	4222	HipHop Clap12
E4	4717	Bd HipHop10
F4	5494	Sd HipHop6
F#4	4224	HipHop Clap14
G4	4221	HipHop Clap11
G#4	2884	Triangle1 Mute
A4	2883	Triangle1 Open
A#4	2843	Tambourine1 Sw
B4	2818	ShakerA 2
C5	4715	Bd HipHop8
C#5	4179	Clap T9-1
D5	5376	Sd T8-1
D#5	5504	Sd HipHop16
E5	5379	Sd T8-4
F5	6123	Tom T8
F#5	5782	HH Closed T8-2
G5	6123	Tom T8
G#5	5782	HH Closed T8-2
A5	6123	Tom T8
A#5	5783	HH Open T8-2
B5	6123	Tom T8
C6	6305	Crash T8-1

Perc Master Kit

Note	Wave Number	Wave Name
C0	3224	Cowbell2
C#0	3276	Djembe2 Lo
D0	3277	Djembe2 Slap
D#0	3278	Djembe2 Mute
E0	3086	Pandeiro1 Open
F0	3089	Pandeiro1 Heel
F#0	3087	Pandeiro1 Thump
G0	3088	Pandeiro1 Tip
G#0	2861	Castanet2 Sw
A0	3281	Djembe3 Mute
A#0	3280	Djembe3 Slap
B0	3279	Djembe3 Lo
C1	3155	Cajon2 Lo
C#1	3154	Cajon2 Foot
D1	3156	Cajon2 Slap
D#1	2892	Hand Clap2 Sw
E1	3157	Cajon2 Mute
F1	6101	Rotary Tom Lo 1-2
F#1	3158	Cajon2 Tip
G1	3471	Sangan Sw
G#1	3159	Cajon2 Ghost1
A1	6098	Rotary Tom Mid 1-2
A#1	3160	Cajon2 Ghost2
B1	3471	Sangan Sw
C2	6095	Rotary Tom Hi 1-2
C#2	3474	Dundun Bell Sw
D2	3455	Kenkeni Sw
D#2	6233	Ride Brite St
E2	6288	China3 St
F2	6237	Ride Brite Cup St
F#2	2846	Tambourine2 Sw
G2	6297	Splash2 St
G#2	3225	Cowbell3 Sw
A2	3052	Paila H
A#2	2880	Vibraslap2
B2	3051	Paila L
C3	2940	Conga2 Hi Heel
C#3	2941	Conga2 Hi Tip
D3	2942	Conga2 Hi Slap 1-2
D#3	2948	Conga2 Hi Mute
E3	2945	Conga2 Hi Open 1-2
F3	3036	Timbale2 Hi Sw
F#3	3040	Timbale2 Lo Sw
G3	3237	ChaCha Bell Sw
G#3	3233	Mambo Bell Sw
A3	3065	Cabasa1B 1-4
A#3	3073	Caxixi 1-2
B3	2997	Bongo2 Hi Mute
C4	2998	Bongo2 Hi Open 1-2
C#4	3001	Bongo2 Lo Mute
D4	3002	Bongo2 Lo Open 1-2
D#4	3218	Claves2
E4	2914	Resin Block Small
F4	2915	Resin Block Large
F#4	2952	Conga2 Lo Slide
G4	2949	Conga2 Lo Open 1-2
G#4	2884	Triangle1 Mute
A4	2883	Triangle1 Open
A#4	2820	ShakerB Sw
B4	2912	Wind Chime 1
C5	3446	TalkingDrum Bend 1-4
C#5	3445	TalkingDrum Mute
D5	3443	TalkingDrum Open
D#5	3444	TalkingDrum Slap
E5	3243	Repique1 Open 1-2
F5	3242	Repique Mute
F#5	3439	Shekere Shake Sw
G5	3442	Shekere Slap
G#5	3240	Samba Tambourim Slap
A5	3239	Samba Tambourim Open
A#5	3241	Samba Tambourim Mute
B5	3127	Surdo2 Mute
C6	3126	Surdo2 Open

Nu Orchestra Kit

Note	Wave Number	Wave Name
C0	3218	Claves2
C#0	5228	Sd Brush Med L
D0	5238	Sd Brush Swir R
D#0	5228	Sd Brush Med L
E0	5241	Sd Brush SwirAtt R
F0	5287	Sd Orch Roll St
F#0	2861	Castanet2 Sw
G0	5254	Sd OrChA 1-2 St
G#0	2855	Stick1
A0	4547	Bd GranCasaB Mfl St
A#0	4544	Bd GranCasaB Hoop St
B0	4532	Bd GranCasaB 1-3 St
C1	4532	Bd GranCasaB 1-3 St
C#1	5109	Sd Beech ClRm St
D1	5272	Sd OrChC 1-4 St
D#1	2889	Hand Clap1 St
E1	5272	Sd OrChC 1-4 St
F1	5939	Tom Power04 1-2St
F#1	2917	OrchTamb Shake 1-2
G1	5939	Tom Power04 1-2St
G#1	2920	OrchTamb Hit Close
A1	5935	Tom Power03 2St
A#1	2921	OrchTamb Hit Open
B1	5935	Tom Power03 2St
C2	5915	Tom Power02 1-2St
C#2	6219	Hand Cymbal Open St
D2	5915	Tom Power02 1-2St
D#2	6248	Ride Njz RL
E2	6288	China3 St
F2	6252	Ride Njz Cup RL
F#2	2843	Tambourine1 Sw
G2	3429	Mondira
G#2	3225	Cowbell3 Sw
A2	6222	Hand Cymbal Mute St
A#2	2880	Vibraslap2
B2	6268	Ride Brush1 RL
C3	4526	Bd GranCasaA Open St
C#3	4529	Bd GranCasaA Mute St
D3	5293	Sd Field 1 St
D#3	2909	Sleigh Bell2
E3	5293	Sd Field 1 St
F3	2872	Wood Block
F#3	2872	Wood Block
G3	4288	HipHop Flex2
G#3	2884	Triangle1 Mute
A3	2883	Triangle1 Open
A#3	2820	ShakerB Sw
B3	3065	Cabasa1B 1-4
C4	387	Timpani2 Hard St-
C#4	387	Timpani2 Hard St-
D4	387	Timpani2 Hard St-
D#4	387	Timpani2 Hard St-
E4	387	Timpani2 Hard St-
F4	387	Timpani2 Hard St-
F#4	387	Timpani2 Hard St-
G4	387	Timpani2 Hard St-
G#4	387	Timpani2 Hard St-
A4	387	Timpani2 Hard St-
A#4	387	Timpani2 Hard St-
B4	387	Timpani2 Hard St-
C5	387	Timpani2 Hard St-
C#5	387	Timpani2 Hard St-
D5	387	Timpani2 Hard St-
D#5	387	Timpani2 Hard St-
E5	387	Timpani2 Hard St-
F5	387	Timpani2 Hard St-
F#5	387	Timpani2 Hard St-
G5	387	Timpani2 Hard St-
G#5	387	Timpani2 Hard St-
A5	387	Timpani2 Hard St-
A#5	387	Timpani2 Hard St-
B5	387	Timpani2 Hard St-
C6	387	Timpani2 Hard St-

Japan Kit

Note	Wave Number	Wave Name
C0	4286	Analog Click
C#0	3483	Wa Taiko
D0	3483	Wa Taiko
D#0	3483	Wa Taiko
E0	3483	Wa Taiko
F0	3483	Wa Taiko
F#0	3483	Wa Taiko
G0	3483	Wa Taiko
G#0	2909	Sleigh Bell2
A0	3488	Oo Taiko2 Zu
A#0	3489	Oo Taiko2 Ka
B0	3487	Oo Taiko2 Don Hard
C1	3487	Oo Taiko2 Don Hard
C#1	3489	Oo Taiko2 Ka
D1	3497	Shime Taiko1 Tsu
D#1	3498	Shime Taiko1 Ku
E1	3496	Shime Taiko1 Ten
F1	3493	Yagura Taiko2 Don
F#1	3480	Chanchiki Ki
G1	3494	Yagura Taiko2 Zu
G#1	3480	Chanchiki Ki
A1	3495	Yagura Taiko2 Ka
A#1	3479	Chanchiki Chan
B1	3484	Oo Taiko1 Don
C2	3484	Oo Taiko1 Don
C#2	3485	Oo Taiko1 Ka
D2	3500	Shime Taiko2 Tsu
D#2	3501	Shime Taiko2 Ku
E2	3499	Shime Taiko2 Ten
F2	3490	Yagura Taiko1 Don
F#2	3482	Atarigane Chi
G2	3491	Yagura Taiko1 Zu
G#2	3482	Atarigane Chi
A2	3492	Yagura Taiko1 Ka
A#2	3481	Atarigane Con
B2	3508	Oo Kawa Ton
C3	3506	Oo Kawa Chon
C#3	3507	Oo Kawa Tsu
D3	3502	Tsuzumi Pon
D#3	3504	Tsuzumi Chi
E3	3503	Tsuzumi Pu
F3	3505	Tsuzumi Ta
F#3	3477	Ainote 1
G3	3502	Tsuzumi Pon
G#3	3504	Tsuzumi Chi
A3	3503	Tsuzumi Pu
A#3	3478	Ainote 2
B3	3505	Tsuzumi Ta
C4	3496	Shime Taiko1 Ten
C#4	3496	Shime Taiko1 Ten
D4	3496	Shime Taiko1 Ten
D#4	3496	Shime Taiko1 Ten
E4	3496	Shime Taiko1 Ten
F4	3496	Shime Taiko1 Ten
F#4	3496	Shime Taiko1 Ten
G4	3496	Shime Taiko1 Ten
G#4	3496	Shime Taiko1 Ten
A4	3496	Shime Taiko1 Ten
A#4	3496	Shime Taiko1 Ten
B4	3496	Shime Taiko1 Ten
C5	1880	Pan Flute
C#5	1880	Pan Flute
D5	1880	Pan Flute
D#5	1880	Pan Flute
E5	1880	Pan Flute
F5	1880	Pan Flute
F#5	1880	Pan Flute
G5	1880	Pan Flute
G#5	1880	Pan Flute
A5	1880	Pan Flute
A#5	1880	Pan Flute
B5	1880	Pan Flute
C6	1880	Pan Flute

Turkish Kit

Note	Wave Number	Wave Name
C0	3217	Claves1
C#0	3573	AsmaDavul L Side 1-2
D0	3577	AsmaDavul R Side 1-2
D#0	3570	AsmaDavulSideBdy 1-2
E0	3576	AsmaDavul Both Sides
F0	3591	KoltukDavulOpenFlam
F#0	3583	KoltukDavulTekeOp1-3
G0	3587	KoltukDavulTekOp 1-3
G#0	3580	Koltuk Davul Dum 1-2
A0	3626	Bendir Teke OpenFlam
A#0	3633	Bendir1 Teke Dead1-2
B0	3630	Bendir1 Tek Dead1-2
C1	3622	Bendir Teke 1-3
C#1	3618	Bendir Tek 1-3
D1	3627	Bendir Slap 1-2
D#1	3615	Bendir Dum 1-2
E1	3713	Sagat1 R Close 1-2
F1	3712	Sagat1 R Open
F#1	3717	Sagat1 L Close 1-2
G1	3716	Sagat1 L Open
G#1	3743	Riq1 Teke Flam
A1	3737	Riq1 Tek Mute 1-2
A#1	3740	Riq1 Teke Damped 1-2
B1	3744	Riq1 TekMtMed 1-2
C2	3730	Riq1 Dum Mute
C#2	3754	Riq1 Cymbal 1-2
D2	3757	Riq1 Cymbal Mute 1-2
D#2	3767	Riq1 Tremolo
E2	3761	Riq1 ShakeA 1-2
F2	3764	Riq1 ShakeB 1-2
F#2	3753	Riq1 Tek Flam
G2	3760	Riq1 Full Open
G#2	3750	Riq1 TekeOpnShrt 1-2
A2	3747	Riq1 TekOpnShrt 1-2
A#2	3734	Riq1 Tek Open 1-2
B2	3731	Riq1 Dum Open 1-2
C3	3837	Hollo FingerDead 1-2
C#3	3834	Hollo Slap 1-2
D3	3831	Hollo Dum 1-2
D#3	4114	Kasik 1-2
E3	4118	Kasik Flam
F3	3858	Tombek Tek Dead Sw
F#3	3860	Tombek Tek Flam
G3	3864	Tombek Teke 1-3
G#3	3854	TombekTekeOthFng 1-3
A3	3850	TombekTekelndFng 1-3
A#3	3846	Tombek Tek 1-3
B3	3843	Tombek Slap 1-2
C4	3861	Tombek Slap Med 1-2
C#4	3840	Tombek Dum 1-2
D4	3950	Darbuka1 Roll Close
D#4	3948	Darbuka1 RollOpen
E4	3949	Darbuka1 TekeDmpFlam
F4	3951	Darbuka1 TekDead 1-3
F#4	3955	Darbuka1 TekDampd1-3
G4	3947	Darbuka1 TekeOpnFlam
G#4	3959	Darbuka1 TekeOpen1-3
A4	3933	Darb1TekeOthFngA 1-3
A#4	3925	Darb1TekeOthFngA 1-3
B4	3917	Darbuka1 Teka1 1-3
C5	3937	Darb1TekeOthFngB 1-3
C#5	3929	Darb1TekeOthFngB 1-3
D5	3921	Darbuka1 TeKB 1-3
D#5	3944	Darbuka1 SlapMed 1-2
E5	3941	Darbuka1 Slap 1-2
F5	3914	Darbuka1 Dum 1-2
F#5	4127	Bonges Tek Roll
G5	4128	Bonges Flam
G#5	4126	Bonges Tek Flam
A5	4122	Bonges Tek 1-2
A#5	4125	Bonges Slap
B5	4129	Bonges Flam Hi
C6	4119	Bonges Dum 1-2

Waveform List

No.	Name	Main Category	Sub Category
1	CF3 Stretch Sw St	Piano	Piano
2	CF3 Stretch Sw Mn	Piano	Piano
3	CF3 Stretch Soft St	Piano	Piano
4	CF3 Stretch Soft Mn	Piano	Piano
5	CF3 Stretch Soft St+	Piano	Piano
6	CF3 Stretch Soft Mn+	Piano	Piano
7	CF3 Stretch Soft St-	Piano	Piano
8	CF3 Stretch Soft Mn-	Piano	Piano
9	CF3 Stretch Med St	Piano	Piano
10	CF3 Stretch Med Mn	Piano	Piano
11	CF3 Stretch Med St+	Piano	Piano
12	CF3 Stretch Med Mn+	Piano	Piano
13	CF3 Stretch Med St-	Piano	Piano
14	CF3 Stretch Med Mn-	Piano	Piano
15	CF3 Stretch Hard St	Piano	Piano
16	CF3 Stretch Hard Mn	Piano	Piano
17	CF3 Stretch Hard St+	Piano	Piano
18	CF3 Stretch Hard Mn+	Piano	Piano
19	CF3 Stretch Hard St-	Piano	Piano
20	CF3 Stretch Hard Mn-	Piano	Piano
21	CF3 Key Off St	Piano	Piano
22	CF3 Key Off L	Piano	Piano
23	CF3 Key Off R	Piano	Piano
24	CF3 Flat Sw St	Piano	Piano
25	CF3 Flat Sw Mn	Piano	Piano
26	CF3 Flat Soft St	Piano	Piano
27	CF3 Flat Soft Mn	Piano	Piano
28	CF3 Flat Soft St+	Piano	Piano
29	CF3 Flat Soft Mn+	Piano	Piano
30	CF3 Flat Soft St-	Piano	Piano
31	CF3 Flat Soft Mn-	Piano	Piano
32	CF3 Flat Med St	Piano	Piano
33	CF3 Flat Med Mn	Piano	Piano
34	CF3 Flat Med St+	Piano	Piano
35	CF3 Flat Med Mn+	Piano	Piano
36	CF3 Flat Med St-	Piano	Piano
37	CF3 Flat Med Mn-	Piano	Piano
38	CF3 Flat Hard St	Piano	Piano
39	CF3 Flat Hard Mn	Piano	Piano
40	CF3 Flat Hard St+	Piano	Piano
41	CF3 Flat Hard Mn+	Piano	Piano
42	CF3 Flat Hard St-	Piano	Piano
43	CF3 Flat Hard Mn-	Piano	Piano
44	S6 Stretch pp St	Piano	Piano
45	S6 Stretch pp Mn	Piano	Piano
46	S6 Stretch pp L	Piano	Piano
47	S6 Stretch pp R	Piano	Piano
48	S6 Stretch pp St Pan	Piano	Piano
49	S6 Stretch pp St+	Piano	Piano
50	S6 Stretch pp Mn+	Piano	Piano
51	S6 Stretch pp St-	Piano	Piano
52	S6 Stretch pp Mn-	Piano	Piano
53	S6 Stretch mp St	Piano	Piano
54	S6 Stretch mp Mn	Piano	Piano
55	S6 Stretch mp L	Piano	Piano
56	S6 Stretch mp R	Piano	Piano
57	S6 Stretch mp St Pan	Piano	Piano
58	S6 Stretch mp St+	Piano	Piano
59	S6 Stretch mp Mn+	Piano	Piano
60	S6 Stretch mp St-	Piano	Piano
61	S6 Stretch mp Mn-	Piano	Piano
62	S6 Stretch mf St	Piano	Piano
63	S6 Stretch mf Mn	Piano	Piano
64	S6 Stretch mf L	Piano	Piano
65	S6 Stretch mf R	Piano	Piano
66	S6 Stretch mf St Pan	Piano	Piano
67	S6 Stretch mf St+	Piano	Piano
68	S6 Stretch mf Mn+	Piano	Piano
69	S6 Stretch mf St-	Piano	Piano
70	S6 Stretch mf Mn-	Piano	Piano
71	S6 Stretch ff St	Piano	Piano
72	S6 Stretch ff Mn	Piano	Piano
73	S6 Stretch ff L	Piano	Piano
74	S6 Stretch ff R	Piano	Piano
75	S6 Stretch ff St Pan	Piano	Piano
76	S6 Stretch ff St+	Piano	Piano
77	S6 Stretch ff Mn+	Piano	Piano
78	S6 Stretch ff St-	Piano	Piano
79	S6 Stretch ff Mn-	Piano	Piano
80	S6 Stretch Sw St	Piano	Piano

No.	Name	Main Category	Sub Category
81	S6 Stretch Sw Mn	Piano	Piano
82	S6 Stretch Sw L	Piano	Piano
83	S6 Stretch Sw R	Piano	Piano
84	S6 Stretch Sw St Pan	Piano	Piano
85	S6 Stretch Sw St2	Piano	Piano
86	S6 Stretch Sw St+	Piano	Piano
87	S6 Stretch Sw Mn+	Piano	Piano
88	S6 Stretch Sw St-	Piano	Piano
89	S6 Stretch Sw Mn-	Piano	Piano
90	S6 Stretch KeyOff St	Piano	Piano
91	S6 Stretch KeyOff Mn	Piano	Piano
92	S6 Stretch KeyOff L	Piano	Piano
93	S6 Stretch KeyOff R	Piano	Piano
94	S6 Stretch KeyOffSPn	Piano	Piano
95	S6 Flat pp St	Piano	Piano
96	S6 Flat pp Mn	Piano	Piano
97	S6 Flat pp L	Piano	Piano
98	S6 Flat pp R	Piano	Piano
99	S6 Flat pp St Pan	Piano	Piano
100	S6 Flat pp St+	Piano	Piano
101	S6 Flat pp Mn+	Piano	Piano
102	S6 Flat pp St-	Piano	Piano
103	S6 Flat pp Mn-	Piano	Piano
104	S6 Flat mp St	Piano	Piano
105	S6 Flat mp Mn	Piano	Piano
106	S6 Flat mp L	Piano	Piano
107	S6 Flat mp R	Piano	Piano
108	S6 Flat mp St Pan	Piano	Piano
109	S6 Flat mp St+	Piano	Piano
110	S6 Flat mp Mn+	Piano	Piano
111	S6 Flat mp St-	Piano	Piano
112	S6 Flat mp Mn-	Piano	Piano
113	S6 Flat mf St	Piano	Piano
114	S6 Flat mf Mn	Piano	Piano
115	S6 Flat mf L	Piano	Piano
116	S6 Flat mf R	Piano	Piano
117	S6 Flat mf St Pan	Piano	Piano
118	S6 Flat mf St+	Piano	Piano
119	S6 Flat mf Mn+	Piano	Piano
120	S6 Flat mf St-	Piano	Piano
121	S6 Flat mf Mn-	Piano	Piano
122	S6 Flat ff St	Piano	Piano
123	S6 Flat ff Mn	Piano	Piano
124	S6 Flat ff L	Piano	Piano
125	S6 Flat ff R	Piano	Piano
126	S6 Flat ff St Pan	Piano	Piano
127	S6 Flat ff St+	Piano	Piano
128	S6 Flat ff Mn+	Piano	Piano
129	S6 Flat ff St-	Piano	Piano
130	S6 Flat ff Mn-	Piano	Piano
131	S6 Flat Sw St	Piano	Piano
132	S6 Flat Sw Mn	Piano	Piano
133	S6 Flat Sw L	Piano	Piano
134	S6 Flat Sw R	Piano	Piano
135	S6 Flat Sw St Pan	Piano	Piano
136	S6 Flat Sw St2	Piano	Piano
137	S6 Flat Sw St+	Piano	Piano
138	S6 Flat Sw Mn+	Piano	Piano
139	S6 Flat Sw St-	Piano	Piano
140	S6 Flat Sw Mn-	Piano	Piano
141	S6 Flat KeyOff St	Piano	Piano
142	S6 Flat KeyOff Mn	Piano	Piano
143	S6 Flat KeyOff L	Piano	Piano
144	S6 Flat KeyOff R	Piano	Piano
145	S6 Flat KeyOff SPan	Piano	Piano
146	Brite Piano	Piano	Piano
147	Brite Piano-	Piano	Piano
148	CFX ppp St	Piano	Piano
149	CFX pp St	Piano	Piano
150	CFX p St	Piano	Piano
151	CFX mp St	Piano	Piano
152	CFX mf St	Piano	Piano
153	CFX f St	Piano	Piano
154	CFX ff St	Piano	Piano
155	CFX fff St	Piano	Piano
156	CFX ffff St	Piano	Piano
157	CFX KeyOff St	Piano	Piano
158	S700 pp St	Piano	Piano
159	S700 mf St	Piano	Piano
160	S700 ff St	Piano	Piano

No.	Name	Main Category	Sub Category
161	Upright Piano Sw	Piano	Piano
162	Upright Piano mp	Piano	Piano
163	Upright Piano f	Piano	Piano
164	Upright Piano ff	Piano	Piano
165	Upright Piano KeyOff	Piano	Piano
166	EP1 Sw	Keys	Rd
167	EP1 Soft	Keys	Rd
168	EP1 Soft+	Keys	Rd
169	EP1 Soft-	Keys	Rd
170	EP1 Med	Keys	Rd
171	EP1 Med+	Keys	Rd
172	EP1 Med-	Keys	Rd
173	EP1 Hard	Keys	Rd
174	EP1 Hard+	Keys	Rd
175	EP1 Hard-	Keys	Rd
176	EP2 Sw	Keys	Rd
177	EP2 Soft1	Keys	Rd
178	EP2 Soft1+	Keys	Rd
179	EP2 Soft1-	Keys	Rd
180	EP2 Soft2	Keys	Rd
181	EP2 Soft2+	Keys	Rd
182	EP2 Soft2-	Keys	Rd
183	EP2 Hard1	Keys	Rd
184	EP2 Hard1+	Keys	Rd
185	EP2 Hard1-	Keys	Rd
186	EP2 Hard2	Keys	Rd
187	EP2 Hard2+	Keys	Rd
188	EP2 Hard2-	Keys	Rd
189	EP3 Sw	Keys	Rd
190	EP3 Soft1	Keys	Rd
191	EP3 Soft1+	Keys	Rd
192	EP3 Soft1-	Keys	Rd
193	EP3 Soft2	Keys	Rd
194	EP3 Soft2+	Keys	Rd
195	EP3 Soft2-	Keys	Rd
196	EP3 Hard1	Keys	Rd
197	EP3 Hard1+	Keys	Rd
198	EP3 Hard1-	Keys	Rd
199	EP3 Hard2	Keys	Rd
200	EP3 Hard2+	Keys	Rd
201	EP3 Hard2-	Keys	Rd
202	EP4 p	Keys	Rd
203	EP4 mp	Keys	Rd
204	EP4 mf	Keys	Rd
205	EP4 f	Keys	Rd
206	EP4 ff	Keys	Rd
207	EP4 KeyOff	Keys	Rd
208	EP Key Off	Keys	Rd
209	Rd Soft p	Keys	Rd
210	Rd Soft mp	Keys	Rd
211	Rd Soft mf	Keys	Rd
212	Rd Soft f	Keys	Rd
213	Rd Soft ff	Keys	Rd
214	Rd Soft KeyOff	Keys	Rd
215	Rd Hard mp	Keys	Rd
216	Rd Hard mf	Keys	Rd
217	Rd Hard f	Keys	Rd
218	Rd Hard ff	Keys	Rd
219	Rd Hard KeyOff	Keys	Rd
220	Rd73 p	Keys	Rd
221	Rd73 mp	Keys	Rd
222	Rd73 mf	Keys	Rd
223	Rd73 f	Keys	Rd
224	Rd73 ff	Keys	Rd
225	Rd73 KeyOff	Keys	Rd
226	Rd78 p	Keys	Rd
227	Rd78 mp	Keys	Rd
228	Rd78 mf	Keys	Rd
229	Rd78 ff	Keys	Rd
230	Rd78 KeyOff	Keys	Rd
231	Rd78 KeyOff	Keys	Rd
232	Rd KeyNoise p	Keys	Rd
233	Rd KeyNoise mf	Keys	Rd
234	Rd KeyNoise f	Keys	Rd
235	Rd KeyNoise ff	Keys	Rd
236	Rd KeyOff f	Keys	Rd
237	W1 Soft	Keys	Wr
238	W1 Soft+	Keys	Wr
239	W1 Soft-	Keys	Wr
240	W1 Med	Keys	Wr

No.	Name	Main Category	Sub Category
241	W1 Med+	Keys	Wr
242	W1 Med-	Keys	Wr
243	W1 Hard	Keys	Wr
244	W1 Hard+	Keys	Wr
245	W1 Hard-	Keys	Wr
246	W1 Key Off	Keys	Wr
247	W2 p	Keys	Wr
248	W2 mf	Keys	Wr
249	W2 f	Keys	Wr
250	W2 ff	Keys	Wr
251	W2 3Sw	Keys	Wr
252	W2 KeyOff	Keys	Wr
253	W3 p	Keys	Wr
254	W3 mp	Keys	Wr
255	W3 mf	Keys	Wr
256	W3 f	Keys	Wr
257	W3 ff	Keys	Wr
258	W3 KeyOff	Keys	Wr
259	Wr KeyNoise p	Keys	Wr
260	Wr KeyNoise mf	Keys	Wr
261	Wr KeyNoise f	Keys	Wr
262	Wr Key Off mf	Keys	Wr
263	Wr Key Off f	Keys	Wr
264	DX1	Keys	FM
265	DX2	Keys	FM
266	DX3	Keys	FM
267	DX4	Keys	FM
268	DX Body Soft	Keys	FM
269	DX Body Med	Keys	FM
270	DX Body Hard	Keys	FM
271	DX Attack1	Keys	FM
272	DX Attack2	Keys	FM
273	DX Attack3	Keys	FM
274	DX Attack4	Keys	FM
275	DX Attack5	Keys	FM
276	Clav1	Keys	Clavi
277	Clav1+	Keys	Clavi
278	Clav1-	Keys	Clavi
279	Clav2	Keys	Clavi
280	Clav2+	Keys	Clavi
281	Clav2-	Keys	Clavi
282	Clav3	Keys	Clavi
283	Clav3+	Keys	Clavi
284	Clav3-	Keys	Clavi
285	Clav4 Med	Keys	Clavi
286	Clav4 Med +	Keys	Clavi
287	Clav4 Med -	Keys	Clavi
288	Clav4 Hard	Keys	Clavi
289	Clav4 Hard +	Keys	Clavi
290	Clav4 Hard -	Keys	Clavi
291	Clav Key Off 1	Keys	Clavi
292	Clav Key Off 2	Keys	Clavi
293	Clav5 mp	Keys	Clavi
294	Clav5 mf	Keys	Clavi
295	Clav5 f	Keys	Clavi
296	Clav5 KeyOff	Keys	Clavi
297	Clav KeyNoise p	Keys	Clavi
298	Clav KeyNoise mf	Keys	Clavi
299	Clav KeyNoise f	Keys	Clavi
300	Clav KeyOff mf	Keys	Clavi
301	Clav KeyOff f	Keys	Clavi
302	Harpichord1	Keys	Other
303	Harpichord2 St	Keys	Other
304	Harpichord2 L	Keys	Other
305	Harpichord2 R	Keys	Other
306	Harpichord2 St+	Keys	Other
307	Harpichord2 L+	Keys	Other
308	Harpichord2 St-	Keys	Other
309	Harpichord2 R+	Keys	Other
310	Harpichord2 L-	Keys	Other
311	Harpichord2 R-	Keys	Other
312	Harpichord2 KOI St	Keys	Other
313	Harpichord2 KOI L	Keys	Other
314	Harpichord2 KOI R	Keys	Other
315	CP70	Keys	Other
316	CP70+	Keys	Other
317	CP70-	Keys	Other
318	CP80 p	Keys	Other
319	CP80 mp	Keys	Other
320	CP80 mf	Keys	Other

No.	Name	Main Category	Sub Category	No.	Name	Main Category	Sub Category	No.	Name	Main Category	Sub Category	No.	Name	Main Category	Sub Category
321	CP80 f	Keys	Other	401	Timpani2 Oct Soft R-	CPerc	Malet	481	Draw 1+3-	Organ	TrnWhl	561	Acc Key Off Chords	Ethnc	Blown
322	CP80 ff	Keys	Other	402	Timpani2 Oct Med St	CPerc	Malet	482	Draw 2+4	Organ	TrnWhl	562	Acc Key On Bass A	Ethnc	Blown
323	CP80 5Sw	Keys	Other	403	Timpani2 Oct Med L	CPerc	Malet	483	Draw 2+4+	Organ	TrnWhl	563	Acc Key On Bass B	Ethnc	Blown
324	CP80 4Sw Soft	Keys	Other	404	Timpani2 Oct Med R	CPerc	Malet	484	Draw 2+4-	Organ	TrnWhl	564	Acc Key Off Bass	Ethnc	Blown
325	CP80 4Sw Hard	Keys	Other	405	Timpani2 Oct Med St+	CPerc	Malet	485	Draw Even	Organ	TrnWhl	565	Nylon1 Open Soft St	Guitr	A.Gtr
326	CP80 3Sw	Keys	Other	406	Timpani2 Oct Med L+	CPerc	Malet	486	Draw Even+	Organ	TrnWhl	566	Nylon1 Open Soft L	Guitr	A.Gtr
327	CP80 KeyOff p	Keys	Other	407	Timpani2 Oct Med R+	CPerc	Malet	487	Draw Even-	Organ	TrnWhl	567	Nylon1 Open Soft R	Guitr	A.Gtr
328	CP80 KeyOff mf	Keys	Other	408	Timpani2 Oct Med St-	CPerc	Malet	488	Draw Odd	Organ	TrnWhl	568	Nylon1 Open Med St	Guitr	A.Gtr
329	CP80 KeyOff f	Keys	Other	409	Timpani2 Oct Med L-	CPerc	Malet	489	Draw Odd+	Organ	TrnWhl	569	Nylon1 Open Med L	Guitr	A.Gtr
330	CP80 KeyOff 3Sw	Keys	Other	410	Timpani2 Oct Med R-	CPerc	Malet	490	Draw Odd-	Organ	TrnWhl	570	Nylon1 Open Med R	Guitr	A.Gtr
331	CP80 KeyOff 2Sw	Keys	Other	411	Timpani2 Oct Hard St	CPerc	Malet	491	Percussion	Organ	TrnWhl	571	Nylon1 Open Hard St	Guitr	A.Gtr
332	ToyEP p	Keys	Other	412	Timpani2 Oct Hard L	CPerc	Malet	492	Percussion+	Organ	TrnWhl	572	Nylon1 Open Hard L	Guitr	A.Gtr
333	ToyEP f	Keys	Other	413	Timpani2 Oct Hard R	CPerc	Malet	493	Percussion-	Organ	TrnWhl	573	Nylon1 Open Hard R	Guitr	A.Gtr
334	ToyEP KeyOff	Keys	Other	414	Timpani2 Oct HardSt+	CPerc	Malet	494	Toneheel1 Fast	Organ	TrnWhl	574	Nylon1 Open Sw St	Guitr	A.Gtr
335	Celesta	Keys	Other	415	Timpani2 Oct Hard L+	CPerc	Malet	495	Toneheel1 Slow	Organ	TrnWhl	575	Nylon1 Open Sw R	Guitr	A.Gtr
336	Vibraphone1	CPerc	Malet	416	Timpani2 Oct Hard R+	CPerc	Malet	496	Toneheel1 Slow	Organ	TrnWhl	576	Nylon1 Open Sw L	Guitr	A.Gtr
337	Vibraphone2 Med	CPerc	Malet	417	Timpani2 Oct HardSt-	CPerc	Malet	497	Toneheel2 Fast	Organ	TrnWhl	577	Nylon1 Open Sw Kb St	Guitr	A.Gtr
338	Vibraphone2 Med+	CPerc	Malet	418	Timpani2 Oct Hard L-	CPerc	Malet	498	Toneheel2 Slow	Organ	TrnWhl	578	Nylon1 Open Sw Kb L	Guitr	A.Gtr
339	Vibraphone2 Med-	CPerc	Malet	419	Timpani2 Oct Hard R-	CPerc	Malet	499	Toneheel3 Fast L	Organ	TrnWhl	579	Nylon1 Open Sw Kb R	Guitr	A.Gtr
340	Vibraphone2 Hard	CPerc	Malet	420	Timpani2 Oct Mflf St	CPerc	Malet	500	Toneheel3 Fast R	Organ	TrnWhl	580	Nylon1 Dead Notes St	Guitr	A.Gtr
341	Vibraphone2 Hard+	CPerc	Malet	421	Timpani2 Oct Mflf L	CPerc	Malet	501	Toneheel3 Fast St	Organ	TrnWhl	581	Nylon1 Dead Notes L	Guitr	A.Gtr
342	Vibraphone2 Hard-	CPerc	Malet	422	Timpani2 Oct Mflf R	CPerc	Malet	502	Toneheel3 Slow L	Organ	TrnWhl	582	Nylon1 Dead Notes R	Guitr	A.Gtr
343	Vibraphone3 p	CPerc	Malet	423	Tubular Bell1	CPerc	Other	503	Toneheel3 Slow R	Organ	TrnWhl	583	Nylon1 Mute St	Guitr	A.Gtr
344	Vibraphone3 mf	CPerc	Malet	424	Tubular Bell2	CPerc	Other	504	Toneheel3 Slow St	Organ	TrnWhl	584	Nylon1 Mute L	Guitr	A.Gtr
345	Vibraphone3 ff	CPerc	Malet	425	Bell	CPerc	Other	505	Toneheel4 Fast	Organ	TrnWhl	585	Nylon1 Mute R	Guitr	A.Gtr
346	Vibraphone3 Sw	CPerc	Malet	426	Bell St1	CPerc	Other	506	Toneheel5 Fast	Organ	TrnWhl	586	Nylon1 Hammer On St	Guitr	A.Gtr
347	Motor Vibes mf	CPerc	Malet	427	Bell St2	CPerc	Other	507	Toneheel6 Fast	Organ	TrnWhl	587	Nylon1 Hammer On L	Guitr	A.Gtr
348	Motor Vibes f	CPerc	Malet	428	Brass Bell	CPerc	Other	508	Clack 1	Organ	TrnWhl	588	Nylon1 Hammer On R	Guitr	A.Gtr
349	Marimba 1	CPerc	Malet	429	Small Bell	CPerc	Other	509	Clack 2	Organ	TrnWhl	589	Nylon1 Slide St	Guitr	A.Gtr
350	Marimba 2	CPerc	Malet	430	Finger Cymbal	CPerc	Other	510	Rotor	Organ	TrnWhl	590	Nylon1 Slide L	Guitr	A.Gtr
351	Glockensiel	CPerc	Malet	431	Hand Bell	CPerc	Other	511	Rotor Whistle	Organ	TrnWhl	591	Nylon1 Slide R	Guitr	A.Gtr
352	Xylophone1	CPerc	Malet	432	Hibashi	CPerc	Other	512	Rotor Grit1	Organ	TrnWhl	592	Nylon1 Harmonics St	Guitr	A.Gtr
353	Xylophone2	CPerc	Malet	433	Stone Hard	CPerc	Other	513	Rotor Grit2	Organ	TrnWhl	593	Nylon1 Harmonics L	Guitr	A.Gtr
354	Timpani1 Sw St	CPerc	Malet	434	Stone Soft	CPerc	Other	514	Compact Electronic	Organ	Other	594	Nylon1 Harmonics R	Guitr	A.Gtr
355	Timpani1 Soft St	CPerc	Malet	435	Wood Bell1	CPerc	Other	515	Compact Electronic-	Organ	Other	595	Nylon1 FX St	S.EFX	MgFX
356	Timpani1 Hard St	CPerc	Malet	436	Wood Bell2	CPerc	Other	516	Portable Electronic	Organ	Other	596	Nylon1 FX L	S.EFX	MgFX
357	Timpani1 Sw L	CPerc	Malet	437	Kalimba	CPerc	Other	517	Portable Electronic-	Organ	Other	597	Nylon1 FX R	S.EFX	MgFX
358	Timpani1 Soft L	CPerc	Malet	438	Gamelan1	CPerc	Other	518	Fr All Tabs	Organ	Other	598	Nylon2 Open Soft	Guitr	A.Gtr
359	Timpani1 Hard L	CPerc	Malet	439	Gamelan2	CPerc	Other	519	Fr Bright Boost	Organ	Other	599	Nylon2 Open Medium	Guitr	A.Gtr
360	Timpani1 Sw R	CPerc	Malet	440	Steel Drum	CPerc	Other	520	Fr Flute	Organ	Other	600	Nylon2 Open Hard	Guitr	A.Gtr
361	Timpani1 Soft R	CPerc	Malet	441	Rock Chorus Vibrato	Organ	TrnWhl	521	Fr String Lo	Organ	Other	601	Nylon2 Open Sw	Guitr	A.Gtr
362	Timpani1 Hard R	CPerc	Malet	442	Rock Percussion	Organ	TrnWhl	522	Fr String Hi	Organ	Other	602	Nylon2 Dead Notes	Guitr	A.Gtr
363	Timpani2 Soft St	CPerc	Malet	443	Rock2	Organ	TrnWhl	523	Fr Trumpet	Organ	Other	603	Nylon2 Hammer On	Guitr	A.Gtr
364	Timpani2 Soft L	CPerc	Malet	444	Rock2+	Organ	TrnWhl	524	Fr Piccolo	Organ	Other	604	Nylon2 Slide	Guitr	A.Gtr
365	Timpani2 Soft R	CPerc	Malet	445	Rock2-	Organ	TrnWhl	525	Fr Pedal	Organ	Other	605	Nylon2 Harmonics	Guitr	A.Gtr
366	Timpani2 Soft St+	CPerc	Malet	446	Jazz w/Percussion	Organ	TrnWhl	526	Fr KeyOff	Organ	Other	606	Nylon2 Strum Noises	S.EFX	MgFX
367	Timpani2 Soft L+	CPerc	Malet	447	Jazz w/Percussion-	Organ	TrnWhl	527	Vx Drawbar1-3	Organ	Other	607	Flamenco Finger p	Guitr	A.Gtr
368	Timpani2 Soft R+	CPerc	Malet	448	Jazz	Organ	TrnWhl	528	Vx DrawbarIV	Organ	Other	608	Flamenco Finger mp	Guitr	A.Gtr
369	Timpani2 Soft St-	CPerc	Malet	449	Jazz+	Organ	TrnWhl	529	Vx KeyOff	Organ	Other	609	Flamenco Finger mf	Guitr	A.Gtr
370	Timpani2 Soft L-	CPerc	Malet	450	Jazz-	Organ	TrnWhl	530	Pipe Organ1 St	Organ	Other	610	Flamenco Finger f	Guitr	A.Gtr
371	Timpani2 Soft R-	CPerc	Malet	451	Full Draw	Organ	TrnWhl	531	Pipe Organ1 L	Organ	Other	611	Flamenco Finger Sw	Guitr	A.Gtr
372	Timpani2 Med St	CPerc	Malet	452	Full Draw+	Organ	TrnWhl	532	Pipe Organ1 R	Organ	Other	612	Flamenco Slide Up	Guitr	A.Gtr
373	Timpani2 Med L	CPerc	Malet	453	Full Draw-	Organ	TrnWhl	533	Pipe Organ2	Organ	Other	613	Flamenco Slide Down	Guitr	A.Gtr
374	Timpani2 Med R	CPerc	Malet	454	Swish	Organ	TrnWhl	534	Pipe Organ3 St	Organ	Other	614	Flamenco Damp KeyOff	Guitr	A.Gtr
375	Timpani2 Med St+	CPerc	Malet	455	Swish-	Organ	TrnWhl	535	Pipe Organ3 L	Organ	Other	615	Flamenco FX1	S.EFX	MgFX
376	Timpani2 Med L+	CPerc	Malet	456	Bow	Organ	TrnWhl	536	Pipe Organ3 R	Organ	Other	616	Flamenco FX2	S.EFX	MgFX
377	Timpani2 Med R+	CPerc	Malet	457	Bow Chorus Vibrato	Organ	TrnWhl	537	Pipe Organ4	Organ	Other	617	Flamenco Shout	S.EFX	SE
378	Timpani2 Med St-	CPerc	Malet	458	Gospel	Organ	TrnWhl	538	Pipe Organ5	Organ	Other	618	Steel1 Open Soft St	Guitr	A.Gtr
379	Timpani2 Med L-	CPerc	Malet	459	Soul	Organ	TrnWhl	539	Harmonium Side	Organ	Other	619	Steel1 Open Soft L	Guitr	A.Gtr
380	Timpani2 Med R-	CPerc	Malet	460	1st Four Draw	Organ	TrnWhl	540	Harmonium Main	Organ	Other	620	Steel1 Open Soft R	Guitr	A.Gtr
381	Timpani2 Hard St	CPerc	Malet	461	Draw 16'	Organ	TrnWhl	541	Accordion1	Organ	Other	621	Steel1 Open Med St	Guitr	A.Gtr
382	Timpani2 Hard L	CPerc	Malet	462	Draw 5 1/3	Organ	TrnWhl	542	Acordion2	Organ	Other	622	Steel1 Open Med L	Guitr	A.Gtr
383	Timpani2 Hard R	CPerc	Malet	463	Draw 8'	Organ	TrnWhl	543	Accordion3	Organ	Other	623	Steel1 Open Med R	Guitr	A.Gtr
384	Timpani2 Hard St+	CPerc	Malet	464	Draw 4'	Organ	TrnWhl	544	Tango Accordion1	Organ	Other	624	Steel1 Open Hard St	Guitr	A.Gtr
385	Timpani2 Hard L+	CPerc	Malet	465	Draw 2 2/3	Organ	TrnWhl	545	Tango Accordion2	Organ	Other	625	Steel1 Open Hard L	Guitr	A.Gtr
386	Timpani2 Hard R+	CPerc	Malet	466	Draw 2'	Organ	TrnWhl	546	Tango Accordion Bass	Organ	Other	626	Steel1 Open Hard R	Guitr	A.Gtr
387	Timpani2 Hard St-	CPerc	Malet	467	Draw 1 3/5	Organ	TrnWhl	547	Mussete Accordion	Organ	Other	627	Steel1 Open Sw St	Guitr	A.Gtr
388	Timpani2 Hard L-	CPerc	Malet	468	Draw 1 1/3	Organ	TrnWhl	548	Steirisch Accordion	Organ	Other	628	Steel1 Open Sw L	Guitr	A.Gtr
389	Timpani2 Hard R-	CPerc	Malet	469	Draw 1"	Organ	TrnWhl	549	StAcc: Mussete	Ethnc	Blown	629	Steel1 Open Sw R	Guitr	A.Gtr
390	Timpani2 Muffl St	CPerc	Malet	470	Draw 16' Of	Organ	TrnWhl	550	StAcc: Mussete KeyOf	Ethnc	Blown	630	Steel1 Open Sw Kb St	Guitr	A.Gtr
391	Timpani2 Muffl L	CPerc	Malet	471	Draw 5 1/3 Of	Organ	TrnWhl	551	StAcc: 1	Ethnc	Blown	631	Steel1 Open Sw Kb L	Guitr	A.Gtr
392	Timpani2 Muffl R	CPerc	Malet	472	Draw 8' Of	Organ	TrnWhl	552	StAcc: 1 KeyOff	Ethnc	Blown	632	Steel1 Open Sw Kb R	Guitr	A.Gtr
393	Timpani2 Oct Soft St	CPerc	Malet	473	Draw 4' Of	Organ	TrnWhl	553	StAcc: 2	Ethnc	Blown	633	Steel1 Hammer On St	Guitr	A.Gtr
394	Timpani2 Oct Soft L	CPerc	Malet	474	Draw 2 2/3 Of	Organ	TrnWhl	554	StAcc: Bass Split	Ethnc	Blown	634	Steel1 Hammer On L	Guitr	A.Gtr
395	Timpani2 Oct Soft R	CPerc	Malet	475	Draw 2' Of	Organ	TrnWhl	555	StAcc: Bass Split KOf	Ethnc	Blown	635	Steel1 Hammer On R	Guitr	A.Gtr
396	Timpani2 Oct SoftSt+	CPerc	Malet	476	Draw 1 3/5 Of	Organ	TrnWhl	556	Acc Key On RH A	Ethnc	Blown	636	Steel1 Slide St	Guitr	A.Gtr
397	Timpani2 Oct Soft L+	CPerc	Malet	477	Draw 1 1/3 Of	Organ	TrnWhl	557	Acc Key On RH B	Ethnc	Blown	637	Steel1 Slide L	Guitr	A.Gtr
398	Timpani2 Oct Soft R+	CPerc	Malet	478	Draw 1' Of	Organ	TrnWhl	558	Acc Key Off RH	Ethnc	Blown	638	Steel1 Slide R	Guitr	A.Gtr
399	Timpani2 Oct SoftSt-	CPerc	Malet	479	Draw 1+3	Organ	TrnWhl	559	Acc Key On Chords A	Ethnc	Blown	639	Steel1 Harmonics St	Guitr	A.Gtr
400	Timpani2 Oct Soft L-	CPerc	Malet	480	Draw 1+3+	Organ	TrnWhl	560	Acc Key On Chords B	Ethnc	Blown	640	Steel1 Harmonics L	Guitr	A.Gtr

No.	Name	Main Category	Sub Category	No.	Name	Main Category	Sub Category	No.	Name	Main Category	Sub Category	No.	Name	Main Category	Sub Category
641	Steel1 Harmonics R	Guitr	A.Gtr	721	60s Clean Mute	Guitr	E.Cln	801	Sitar2 Hard-	Ethnc	Pluk	881	Pull Dead	Bass	EBass
642	Steel1 Mute St	Guitr	A.Gtr	722	60s Clean Hammer On	Guitr	E.Cln	802	Sitar Waves1	Ethnc	Pluk	882	Fretless	Bass	EBass
643	Steel1 Mute L	Guitr	A.Gtr	723	60s Clean Slide	Guitr	E.Cln	803	Sitar Waves2	Ethnc	Pluk	883	Fretless Harmonics	Bass	EBass
644	Steel1 Mute R	Guitr	A.Gtr	724	60s Clean Harmonics	Guitr	E.Cln	804	Sitar Waves3	Ethnc	Pluk	884	Fretless+	Bass	EBass
645	Steel1 Dead Notes St	Guitr	A.Gtr	725	60s Clean FX	S.EFX	MgFX	805	Sitar Waves4	Ethnc	Pluk	885	Fretless-	Bass	EBass
646	Steel1 Dead Notes L	Guitr	A.Gtr	726	60s Clean Slap	Guitr	E.Cln	806	Sitar Waves5	Ethnc	Pluk	886	Fretless Dead	Bass	EBass
647	Steel1 Dead Notes R	Guitr	A.Gtr	727	1Coil Open Sw	Guitr	E.Cln	807	Sitar Waves6	Ethnc	Pluk	887	Electric Bass FX	Bass	EBass
648	Steel1 FX St	S.EFX	MgFX	728	1Coil Open Soft	Guitr	E.Cln	808	Tambura	Ethnc	Pluk	888	Violin1 Non-Vib	Strng	Solo
649	Steel1 FX L	S.EFX	MgFX	729	1Coil Open Med	Guitr	E.Cln	809	Tambura Waves1	Ethnc	Pluk	889	Violin1 Non-Vib+	Strng	Solo
650	Steel1 FX R	S.EFX	MgFX	730	1Coil Open Hard	Guitr	E.Cln	810	Tambura Waves2	Ethnc	Pluk	890	Violin1 Non-Vib-	Strng	Solo
651	Steel2 Open p	Guitr	A.Gtr	731	1Coil Dead	Guitr	E.Cln	811	Tambura Waves3	Ethnc	Pluk	891	Violin1 Non-Vib Of	Strng	Solo
652	Steel2 Open mp	Guitr	A.Gtr	732	1Coil Mute	Guitr	E.Cln	812	Santur	Ethnc	Pluk	892	Violin1 Non-Vib+ Of	Strng	Solo
653	Steel2 Open mf	Guitr	A.Gtr	733	1Coil Hammer On	Guitr	E.Cln	813	Ud	Ethnc	Pluk	893	Violin1 Non-Vib- Of	Strng	Solo
654	Steel2 Open f	Guitr	A.Gtr	734	1Coil Slide	Guitr	E.Cln	814	Kanun	Ethnc	Pluk	894	Violin1 St	Strng	Solo
655	Steel2 Open Sw	Guitr	A.Gtr	735	1Coil Harmonics	Guitr	E.Cln	815	Baglama	Ethnc	Pluk	895	Violin1 L	Strng	Solo
656	Steel2 Slide mp	Guitr	A.Gtr	736	1Coil FX	S.EFX	MgFX	816	Bouzouki	Ethnc	Pluk	896	Violin1 R	Strng	Solo
657	Steel2 Slide mf	Guitr	A.Gtr	737	Jazz Guitar	Guitr	E.Cln	817	Shamisen	Ethnc	Pluk	897	Violin1 St+	Strng	Solo
658	Steel2 Slide Sw	Guitr	A.Gtr	738	Jazz Open Soft	Guitr	E.Cln	818	Koto	Ethnc	Pluk	898	Violin1 L+	Strng	Solo
659	Steel2 Harmonics mp	Guitr	A.Gtr	739	Jazz Open Med	Guitr	E.Cln	819	Acoustic1 Med	Bass	ABass	899	Violin1 R+	Strng	Solo
660	Steel2 Harmonics mf	Guitr	A.Gtr	740	Jazz Open Hard	Guitr	E.Cln	820	Acoustic1 Hard	Bass	ABass	900	Violin1 St-	Strng	Solo
661	Steel2 Harmonics Sw	Guitr	A.Gtr	741	Jazz Open Sw	Guitr	E.Cln	821	Acoustic1 Harmonics	Bass	ABass	901	Violin1 L-	Strng	Solo
662	Steel2 Mute mp	Guitr	A.Gtr	742	Jazz Dead Med	Guitr	E.Cln	822	Acoustic1 Dead	Bass	ABass	902	Violin1 R-	Strng	Solo
663	Steel2 Mute mf	Guitr	A.Gtr	743	Jazz Dead Hard	Guitr	E.Cln	823	Acoustic1 FX1	Bass	ABass	903	Violin1 St Of	Strng	Solo
664	Steel2 Mute Sw	Guitr	A.Gtr	744	Jazz Hammer On	Guitr	E.Cln	824	Acoustic1 FX2	Bass	ABass	904	Violin1 L Of	Strng	Solo
665	Steel2 Dead p	Guitr	A.Gtr	745	Jazz Slide	Guitr	E.Cln	825	Acoustic1 Med+	Bass	ABass	905	Violin1 R Of	Strng	Solo
666	Steel2 Dead mp	Guitr	A.Gtr	746	Jazz Harmonics	Guitr	E.Cln	826	Acoustic1 Hard+	Bass	ABass	906	Violin2 1st St	Strng	Solo
667	Steel2 Dead mf	Guitr	A.Gtr	747	Jazz FX	S.EFX	MgFX	827	Acoustic1 Med-	Bass	ABass	907	Violin2 1st St Of	Strng	Solo
668	Steel2 Dead f	Guitr	A.Gtr	748	Vintage Amp1	Guitr	E.Cln	828	Acoustic1 Hard-	Bass	ABass	908	Violin2 2nd St	Strng	Solo
669	Steel2 Dead Sw	Guitr	A.Gtr	749	Vintage Amp2	Guitr	E.Cln	829	Acoustic2 Soft	Bass	ABass	909	Violin2 2nd St Of	Strng	Solo
670	Steel2 FX	S.EFX	MgFX	750	Neck Pickup	Guitr	E.Cln	830	Acoustic2 Hard	Bass	ABass	910	Viola1 St	Strng	Solo
671	Steel3 Pick Open p	Guitr	A.Gtr	751	TC Clin Pick Open pp	Guitr	E.Cln	831	Acoustic2 Soft Of	Bass	ABass	911	Viola1 L	Strng	Solo
672	Steel3 Pick Open mf	Guitr	A.Gtr	752	TC Clin Pick Open mf	Guitr	E.Cln	832	Acoustic2 Hard Of	Bass	ABass	912	Viola1 R	Strng	Solo
673	Steel3 Pick Open f	Guitr	A.Gtr	753	TC Clin Pick Open ff	Guitr	E.Cln	833	Acoustic2 Dead	Bass	ABass	913	Viola1 St+	Strng	Solo
674	Steel3 Pick Open Sw	Guitr	A.Gtr	754	TC Clin Pick Open Sw	Guitr	E.Cln	834	Pick Open	Bass	EBass	914	Viola1 L+	Strng	Solo
675	Steel3 Pick Slides	Guitr	A.Gtr	755	TC Clin Pick Slide f	Guitr	E.Cln	835	Pick Harmonics	Bass	EBass	915	Viola1 R+	Strng	Solo
676	Steel3 Hammer	Guitr	A.Gtr	756	TC Clin Pick Mute mp	Guitr	E.Cln	836	Pick Mute	Bass	EBass	916	Viola1 St-	Strng	Solo
677	Steel3 Pick Harmonics	Guitr	A.Gtr	757	TC Clin Pick Mute mf	Guitr	E.Cln	837	Pick Dead	Bass	EBass	917	Viola1 L-	Strng	Solo
678	Steel3 Pick Mute St	Guitr	A.Gtr	758	TC Clin Pick Mute Sw	Guitr	E.Cln	838	Pick Open+	Bass	EBass	918	Viola1 R-	Strng	Solo
679	Steel3 Pick Mute Hrd	Guitr	A.Gtr	759	TC Clin Pick Dead mp	Guitr	E.Cln	839	Pick Mute+	Bass	EBass	919	Viola1 St Of	Strng	Solo
680	Steel3 Pick Dead p	Guitr	A.Gtr	760	TC Clin Pick Dead mf	Guitr	E.Cln	840	Pick Open-	Bass	EBass	920	Viola1 L Of	Strng	Solo
681	Steel3 Pick Dead f	Guitr	A.Gtr	761	TC Clin Pick Dead Sw	Guitr	E.Cln	841	Pick Mute-	Bass	EBass	921	Viola1 R Of	Strng	Solo
682	Steel3 Pick FX	S.EFX	MgFX	762	TC Clin Fing p	Guitr	E.Cln	842	Pick Rndwound1 Med	Bass	EBass	922	Viola2 St	Strng	Solo
683	Steel3 Finger Opn p	Guitr	A.Gtr	763	TC Clin Fing mf	Guitr	E.Cln	843	Pick Rndwound1 Hard	Bass	EBass	923	Viola2 St Of	Strng	Solo
684	Steel3 Finger Opn mf	Guitr	A.Gtr	764	TC Clin Fing f	Guitr	E.Cln	844	Pick Rndwound1 Med+	Bass	EBass	924	Cello1 St	Strng	Solo
685	Steel3 Finger Opn f	Guitr	A.Gtr	765	TC Clin Fing Sw	Guitr	E.Cln	845	Pick Rndwound1 Hard+	Bass	EBass	925	Cello1 L+	Strng	Solo
686	Steel3 Finger SlpSt	Guitr	A.Gtr	766	TC Clin Fing Slap Amp	Guitr	E.Cln	846	Pick Rndwound1 Med-	Bass	EBass	926	Cello1 R	Strng	Solo
687	Steel3 Finger SlpHrd	Guitr	A.Gtr	767	TC Clin Fing Slap Lin	Guitr	E.Cln	847	Pick Rndwound1 Hard-	Bass	EBass	927	Cello1 St+	Strng	Solo
688	Steel3 Finger Slide	S.EFX	MgFX	768	TC Clin Fing Slides	Guitr	E.Cln	848	Pick Rndwound2 Open	Bass	EBass	928	Cello1 L+	Strng	Solo
689	Steel3 Finger Hrmncs	Guitr	A.Gtr	769	TC Clin Fing Dead mp	Guitr	E.Cln	849	Pick Rndwound2 Open+	Bass	EBass	929	Cello1 R+	Strng	Solo
690	Steel3 Finger Dead p	Guitr	A.Gtr	770	TC Clin Fing Dead mf	Guitr	E.Cln	850	Pick Rndwound2 Open-	Bass	EBass	930	Cello1 St-	Strng	Solo
691	Steel3 Finger Dead f	Guitr	A.Gtr	771	TC Clin Fing Dead Sw	Guitr	E.Cln	851	Pick Rndwound2 Mute	Bass	EBass	931	Cello1 L-	Strng	Solo
692	Steel3 Finger FX	Guitr	A.Gtr	772	Distortion Open	Guitr	E.Dst	852	Pick Rndwound2 Mute+	Bass	EBass	932	Cello1 R-	Strng	Solo
693	High Strings Soft St	Guitr	A.Gtr	773	Distortion Harmonics	Guitr	E.Dst	853	Pick Rndwound2 Mute-	Bass	EBass	933	Cello1 St Of	Strng	Solo
694	High Strings Soft L	Guitr	A.Gtr	774	Distortion Mute	Guitr	E.Dst	854	Pick Rndwound2 Dead	Bass	EBass	934	Cello1 L Of	Strng	Solo
695	High Strings Soft R	Guitr	A.Gtr	775	Overdrive Open	Guitr	E.Dst	855	Pick Rndwound2 Harm	Bass	EBass	935	Cello1 R Of	Strng	Solo
696	High Strings Hard St	Guitr	A.Gtr	776	Overdrive Mute	Guitr	E.Dst	856	Pick Rndwound2 FX	Bass	EBass	936	Cello2 St	Strng	Solo
697	High Strings Hard L	Guitr	A.Gtr	777	Distortion FX	S.EFX	MgFX	857	Pick Flatwound	Bass	EBass	937	Cello2 St Of	Strng	Solo
698	High Strings Hard R	Guitr	A.Gtr	778	Dist/Overdrive FX	S.EFX	MgFX	858	Pick Flatwound+	Bass	EBass	938	Contrabass St	Strng	Solo
699	High Strings FX St	S.EFX	MgFX	779	Feedback	Guitr	E.Dst	859	Pick Flatwound-	Bass	EBass	939	Contrabass L	Strng	Solo
700	High Strings FX L	S.EFX	MgFX	780	Power Chord St	Guitr	E.Dst	860	Finger Med	Bass	EBass	940	Contrabass R	Strng	Solo
701	High Strings FX R	S.EFX	MgFX	781	Power Chord Mono	Guitr	E.Dst	861	Finger Hard	Bass	EBass	941	Contrabass St+	Strng	Solo
702	High Strings FX2 St	S.EFX	MgFX	782	Play FX Mix	S.EFX	MgFX	862	Finger Harmonics	Bass	EBass	942	Contrabass L+	Strng	Solo
703	Clean Open Med	Guitr	E.Cln	783	Power Chord FX St	S.EFX	MgFX	863	Finger Med+	Bass	EBass	943	Contrabass R+	Strng	Solo
704	Clean Open Hard	Guitr	E.Cln	784	Power Chord FX Mono	S.EFX	MgFX	864	Finger Hard+	Bass	EBass	944	Contrabass St-	Strng	Solo
705	Clean Open Sw	Guitr	E.Cln	785	Banjo1	Guitr	A.Gtr	865	Finger Med-	Bass	EBass	945	Contrabass L-	Strng	Solo
706	Clean Open Sw Kb	Guitr	E.Cln	786	Banjo2 Med	Guitr	A.Gtr	866	Finger Hard-	Bass	EBass	946	Contrabass R-	Strng	Solo
707	Clean Hammer On	Guitr	E.Cln	787	Banjo2 Med+	Guitr	A.Gtr	867	Finger Dead	Bass	EBass	947	Contrabass St Of	Strng	Solo
708	Clean Slap	Guitr	E.Cln	788	Banjo2 Med-	Guitr	A.Gtr	868	Finger Rndwound St	Bass	EBass	948	Contrabass L Of	Strng	Solo
709	Clean Slide	Guitr	E.Cln	789	Banjo2 Hard	Guitr	A.Gtr	869	Finger Rndwound Slt	Bass	EBass	949	Contrabass R Of	Strng	Solo
710	Clean Harmonics	Guitr	E.Cln	790	Banjo2 Hard+	Guitr	A.Gtr	870	Finger Rndwound Slt-	Bass	EBass	950	Solo Comb1 St	Strng	Solo
711	Clean Mute	Guitr	E.Cln	791	Banjo2 Hard-	Guitr	A.Gtr	871	Finger Rndwound Hrd	Bass	EBass	951	Solo Comb1 L	Strng	Solo
712	Clean Dead	Guitr	E.Cln	792	Sitar1	Ethnc	Pluk	872	Finger Rndwound Hrd+	Bass	EBass	952	Solo Comb1 R	Strng	Solo
713	Clean FX	S.EFX	MgFX	793	Sitar2 Soft	Ethnc	Pluk	873	Finger Rndwound Hrd-	Bass	EBass	953	Solo Comb1 St+	Strng	Solo
714	60s Clean Open Soft	Guitr	E.Cln	794	Sitar2 Soft+	Ethnc	Pluk	874	Finger Rndwound Dead	Bass	EBass	954	Solo Comb1 L+	Strng	Solo
715	60s Clean Open Med	Guitr	E.Cln	795	Sitar2 Soft-	Ethnc	Pluk	875	Finger Rndwound Harm	Bass	EBass	955	Solo Comb1 R+	Strng	Solo
716	60s Clean Open Hard	Guitr	E.Cln	796	Sitar2 Med	Ethnc	Pluk	876	Thumb/Pull Hard	Bass	EBass	956	Solo Comb1 St-	Strng	Solo
717	60s Clean Open Sw	Guitr	E.Cln	797	Sitar2 Med+	Ethnc	Pluk	877	Thumb Hard	Bass	EBass	957	Solo Comb1 L-	Strng	Solo
718	60s Clean Open Sw Kb	Guitr	E.Cln	798	Sitar2 Med-	Ethnc	Pluk	878	Thumb Harmonics	Bass	EBass	958	Solo Comb1 R-	Strng	Solo
719	60s Clean Open Sw2	Guitr	E.Cln	799	Sitar2 Hard	Ethnc	Pluk	879	Thumb Soft	Bass	EBass	959	Solo Comb1 St Of	Strng	Solo
720	60s Clean Dead	Guitr	E.Cln	800	Sitar2 Hard+	Ethnc	Pluk	880	Thumb Dead	Bass	EBass	960	Solo Comb1 L Of	Strng	Solo

No.	Name	Main Category	Sub Category	No.	Name	Main Category	Sub Category	No.	Name	Main Category	Sub Category	No.	Name	Main Category	Sub Category
961	Solo Combi1 R Of	Strng	Solo	1041	OrchStrgs Hard R+	Strng	Ensem	1121	Violins 1st p St	Strng	Ensem	1201	Orch Harp2 Soft R-	Strng	Pizz
962	Solo Combi2 St	Strng	Solo	1042	OrchStrgs Hard R-	Strng	Ensem	1122	Violins 1st p St Of	Strng	Ensem	1202	Orch Harp2 Med St	Strng	Pizz
963	Solo Combi2 L	Strng	Solo	1043	OrchStrgs Hard St Of	Strng	Ensem	1123	Violins 1st mf St	Strng	Ensem	1203	Orch Harp2 Med L	Strng	Pizz
964	Solo Combi2 R	Strng	Solo	1044	OrchStrgs Hard L Of	Strng	Ensem	1124	Violins 1st mf St Of	Strng	Ensem	1204	Orch Harp2 Med R	Strng	Pizz
965	Solo Combi2 St Of	Strng	Solo	1045	OrchStrgs Hard R Of	Strng	Ensem	1125	Violins 1st f St	Strng	Ensem	1205	Orch Harp2 Med St+	Strng	Pizz
966	Solo Combi2 L Of	Strng	Solo	1046	Sect Strgs Soft St	Strng	Ensem	1126	Violins 1st f St Of	Strng	Ensem	1206	Orch Harp2 Med L+	Strng	Pizz
967	Solo Combi2 R Of	Strng	Solo	1047	Sect Strgs Soft L	Strng	Ensem	1127	Violins 1st Sw St	Strng	Ensem	1207	Orch Harp2 Med R+	Strng	Pizz
968	Solo Combi3 St	Strng	Solo	1048	Sect Strgs Soft R	Strng	Ensem	1128	Violins 1st Sw St Of	Strng	Ensem	1208	Orch Harp2 Med St-	Strng	Pizz
969	Solo Combi3 L	Strng	Solo	1049	Sect Strgs Soft St+	Strng	Ensem	1129	Violins 2nd p St	Strng	Ensem	1209	Orch Harp2 Med L-	Strng	Pizz
970	Solo Combi3 R	Strng	Solo	1050	Sect Strgs Soft L+	Strng	Ensem	1130	Violins 2nd p St Of	Strng	Ensem	1210	Orch Harp2 Med R-	Strng	Pizz
971	Solo Combi3 St Of	Strng	Solo	1051	Sect Strgs Soft R+	Strng	Ensem	1131	Violins 2nd mf St	Strng	Ensem	1211	Orch Harp3 p	Strng	Pizz
972	Solo Combi3 L Of	Strng	Solo	1052	Sect Strgs Soft St-	Strng	Ensem	1132	Violins 2nd mf St Of	Strng	Ensem	1212	Orch Harp3 mf	Strng	Pizz
973	Solo Combi3 R Of	Strng	Solo	1053	Sect Strgs Soft L-	Strng	Ensem	1133	Violins 2nd f St	Strng	Ensem	1213	CelticHarp p	Ethnc	Pluk
974	Solo Spiccato Combi	Strng	Solo	1054	Sect Strgs Soft R-	Strng	Ensem	1134	Violins 2nd f St Of	Strng	Ensem	1214	CelticHarp mf	Ethnc	Pluk
975	Solo Spiccato Combi+	Strng	Solo	1055	Sect Strgs SoftSt Of	Strng	Ensem	1135	Violins 2nd Sw St	Strng	Ensem	1215	CelticHarp f	Ethnc	Pluk
976	Solo Spiccato Combi-	Strng	Solo	1056	Sect Strgs Soft L Of	Strng	Ensem	1136	Violins 2nd Sw St Of	Strng	Ensem	1216	CelticHarp KeyOff	Ethnc	Pluk
977	Celtic Violin mf	Ethnc	Bowed	1057	Sect Strgs Soft R Of	Strng	Ensem	1137	Violas mp St	Strng	Ensem	1217	CelticHarp Gliss1	Ethnc	Pluk
978	Celtic Violin mf Of	Ethnc	Bowed	1058	Sect Strgs Med St	Strng	Ensem	1138	Violas mp St Of	Strng	Ensem	1218	CelticHarp Gliss2	Ethnc	Pluk
979	Celtic Violin f	Ethnc	Bowed	1059	Sect Strgs Med L	Strng	Ensem	1139	Violas mf St	Strng	Ensem	1219	Trumpet1 Med	Brass	Solo
980	Celtic Violin f Of	Ethnc	Bowed	1060	Sect Strgs Med R	Strng	Ensem	1140	Violas mf St Of	Strng	Ensem	1220	Trumpet1 Hard	Brass	Solo
981	Celtic Violin Sw	Ethnc	Bowed	1061	Sect Strgs Med St+	Strng	Ensem	1141	Violas f St	Strng	Ensem	1221	Trumpet1 Med Of	Brass	Solo
982	Celtic Violin Sw Of	Ethnc	Bowed	1062	Sect Strgs Med L+	Strng	Ensem	1142	Violas f St Of	Strng	Ensem	1222	Trumpet1 Hard Of	Brass	Solo
983	Kernan	Ethnc	Bowed	1063	Sect Strgs Med R+	Strng	Ensem	1143	Violas Sw St	Strng	Ensem	1223	Trumpet2	Brass	Solo
984	Kernan Of	Ethnc	Bowed	1064	Sect Strgs Med St-	Strng	Ensem	1144	Violas Sw St Of	Strng	Ensem	1224	Trumpet2+	Brass	Solo
985	Ensemble Mix	Strng	Ensem	1065	Sect Strgs Med L-	Strng	Ensem	1145	Violas Sw St Of	Strng	Ensem	1225	Trumpet2-	Brass	Solo
986	Ensemble Mix St	Strng	Ensem	1066	Sect Strgs Med R-	Strng	Ensem	1146	Cellos p St Of	Strng	Ensem	1226	Trumpet2 Of	Brass	Solo
987	Ensemble Mix L	Strng	Ensem	1067	Sect Strgs Med St Of	Strng	Ensem	1147	Cellos mf St	Strng	Ensem	1227	Trumpet3 p	Brass	Solo
988	Ensemble Mix R	Strng	Ensem	1068	Sect Strgs Med L Of	Strng	Ensem	1148	Cellos mf St Of	Strng	Ensem	1228	Trumpet3 p Of	Brass	Solo
989	Ensemble Mix St Of	Strng	Ensem	1069	Sect Strgs Med R Of	Strng	Ensem	1149	Cellos f St	Strng	Ensem	1229	Trumpet3 mp	Brass	Solo
990	Ensemble Mix L Of	Strng	Ensem	1070	Sect Strgs Hard St	Strng	Ensem	1150	Cellos f St Of	Strng	Ensem	1230	Trumpet3 mp Of	Brass	Solo
991	Ensemble Mix R Of	Strng	Ensem	1071	Sect Strgs Hard L	Strng	Ensem	1151	Cellos Sw St	Strng	Ensem	1231	Trumpet3 mf	Brass	Solo
992	Ensemble Mute St	Strng	Ensem	1072	Sect Strgs Hard R	Strng	Ensem	1152	Cellos Sw St Of	Strng	Ensem	1232	Trumpet3 mf Of	Brass	Solo
993	Ensemble Mute	Strng	Ensem	1073	Sect Strgs Hard St+	Strng	Ensem	1153	ContBasses p St	Strng	Ensem	1233	Trumpet3 f	Brass	Solo
994	Ensemble Mute-	Strng	Ensem	1074	Sect Strgs Hard L+	Strng	Ensem	1154	ContBasses p St Of	Strng	Ensem	1234	Trumpet3 f Of	Brass	Solo
995	Ensemble Mute St Of	Strng	Ensem	1075	Sect Strgs Hard R+	Strng	Ensem	1155	ContBasses mf St	Strng	Ensem	1235	Trumpet3 ff	Brass	Solo
996	Ensemble Mute Of	Strng	Ensem	1076	Sect Strgs Hard St-	Strng	Ensem	1156	ContBasses mf St Of	Strng	Ensem	1236	Trumpet3 ff Of	Brass	Solo
997	Ensemble Mute - Of	Strng	Ensem	1077	Sect Strgs Hard L-	Strng	Ensem	1157	ContBasses f St	Strng	Ensem	1237	Trumpet3 Sw	Brass	Solo
998	Hard Ensemble St	Strng	Ensem	1078	Sect Strgs Hard R-	Strng	Ensem	1158	ContBasses f St Of	Strng	Ensem	1238	Trumpet3 Sw Of	Brass	Solo
999	Hard Ensemble St+	Strng	Ensem	1079	Sect Strgs Hard StOf	Strng	Ensem	1159	ContBasses Sw St	Strng	Ensem	1239	Trumpet Mute	Brass	Solo
1000	Hard Ensemble St-	Strng	Ensem	1080	Sect Strgs Hard L Of	Strng	Ensem	1160	ContBasses Sw St Of	Strng	Ensem	1240	Trumpet Mute Of	Brass	Solo
1001	Hard Ensemble L	Strng	Ensem	1081	Sect Strgs Hard R Of	Strng	Ensem	1161	Pizzicato1 St	Strng	Pizz	1241	Soft Trumpet Soft	Brass	Solo
1002	Hard Ensemble L+	Strng	Ensem	1082	Sect Strgs Gliss St	Strng	Ensem	1162	Pizzicato1 Mono	Strng	Pizz	1242	Soft Trumpet Soft-	Brass	Solo
1003	Hard Ensemble L-	Strng	Ensem	1083	Sect Strgs Gliss L	Strng	Ensem	1163	Pizzicato2	Strng	Pizz	1243	Soft Trumpet Soft-	Brass	Solo
1004	Hard Ensemble R	Strng	Ensem	1084	Sect Strgs Gliss R	Strng	Ensem	1164	Pop Pizzicato	Strng	Pizz	1244	Soft Trumpet Soft Of	Brass	Solo
1005	Hard Ensemble R+	Strng	Ensem	1085	Sect Strgs Gliss St+	Strng	Ensem	1165	Large Pizzicato St	Strng	Pizz	1245	Soft Trumpet Med	Brass	Solo
1006	Hard Ensemble R-	Strng	Ensem	1086	Sect Strgs Gliss L+	Strng	Ensem	1166	Large Pizzicato L	Strng	Pizz	1246	Soft Trumpet Med+	Brass	Solo
1007	Hard Ensemble St Of	Strng	Ensem	1087	Sect Strgs Gliss R+	Strng	Ensem	1167	Large Pizzicato R	Strng	Pizz	1247	Soft Trumpet Med-	Brass	Solo
1008	Hard Ensemble L Of	Strng	Ensem	1088	Sect Strgs Gliss St-	Strng	Ensem	1168	Large Pizzicato St+	Strng	Pizz	1248	Soft Trumpet Med Of	Brass	Solo
1009	Hard Ensemble R Of	Strng	Ensem	1089	Sect Strgs Gliss L-	Strng	Ensem	1169	Large Pizzicato L+	Strng	Pizz	1249	Trumpet Vib Soft	Brass	Solo
1010	OrchStrgs Soft St	Strng	Ensem	1090	Sect Strgs Gliss R-	Strng	Ensem	1170	Large Pizzicato R+	Strng	Pizz	1250	Trumpet Vib Soft+	Brass	Solo
1011	OrchStrgs Soft St+	Strng	Ensem	1091	Sect Strgs Spicc St	Strng	Ensem	1171	Large Pizzicato St-	Strng	Pizz	1251	Trumpet Vib Soft-	Brass	Solo
1012	OrchStrgs Soft St-	Strng	Ensem	1092	Sect Strgs Spicc L	Strng	Ensem	1172	Large Pizzicato L-	Strng	Pizz	1252	Trumpet Vib Soft Of	Brass	Solo
1013	OrchStrgs Soft L	Strng	Ensem	1093	Sect Strgs Spicc R	Strng	Ensem	1173	Large Pizzicato R-	Strng	Pizz	1253	Trumpet Vib Med	Brass	Solo
1014	OrchStrgs Soft L+	Strng	Ensem	1094	Sect Strgs Spicc St+	Strng	Ensem	1174	Live Pizzct Soft St	Strng	Pizz	1254	Trumpet Vib Med+	Brass	Solo
1015	OrchStrgs Soft L-	Strng	Ensem	1095	Sect Strgs Spicc L+	Strng	Ensem	1175	Live Pizzct Soft L	Strng	Pizz	1255	Trumpet Vib Med-	Brass	Solo
1016	OrchStrgs Soft R	Strng	Ensem	1096	Sect Strgs Spicc R+	Strng	Ensem	1176	Live Pizzct Soft R	Strng	Pizz	1256	Trumpet Vib Med Of	Brass	Solo
1017	OrchStrgs Soft R+	Strng	Ensem	1097	Sect Strgs Spicc St-	Strng	Ensem	1177	Live Pizzct Soft St+	Strng	Pizz	1257	Trumpet Vib Hard	Brass	Solo
1018	OrchStrgs Soft R-	Strng	Ensem	1098	Sect Strgs Spicc L-	Strng	Ensem	1178	Live Pizzct Soft L+	Strng	Pizz	1258	Trumpet Vib Hard+	Brass	Solo
1019	OrchStrgs Soft St Of	Strng	Ensem	1099	Sect Strgs Spicc R-	Strng	Ensem	1179	Live Pizzct Soft R+	Strng	Pizz	1259	Trumpet Vib Hard-	Brass	Solo
1020	OrchStrgs Soft L Of	Strng	Ensem	1100	Tremolo Strings St	Strng	Ensem	1180	Live Pizzct Soft St-	Strng	Pizz	1260	Trumpet Vib Hard Of	Brass	Solo
1021	OrchStrgs Soft R Of	Strng	Ensem	1101	Tremolo Strings L	Strng	Ensem	1181	Live Pizzct Soft L-	Strng	Pizz	1261	Trumpet Shake	Brass	Solo
1022	OrchStrgs Med St	Strng	Ensem	1102	Tremolo Strings R	Strng	Ensem	1182	Live Pizzct Soft R-	Strng	Pizz	1262	Trumpet Shake+	Brass	Solo
1023	OrchStrgs Med St+	Strng	Ensem	1103	Tremolo Strings St+	Strng	Ensem	1183	Live Pizzct Hard St	Strng	Pizz	1263	Trumpet Shake-	Brass	Solo
1024	OrchStrgs Med St-	Strng	Ensem	1104	Tremolo Strings L+	Strng	Ensem	1184	Live Pizzct Hard L	Strng	Pizz	1264	Trumpet Shake Of	Brass	Solo
1025	OrchStrgs Med L	Strng	Ensem	1105	Tremolo Strings R+	Strng	Ensem	1185	Live Pizzct Hard R	Strng	Pizz	1265	Piccolo Tp pp	Brass	Solo
1026	OrchStrgs Med L+	Strng	Ensem	1106	Tremolo Strings St-	Strng	Ensem	1186	Live Pizzct Hard St+	Strng	Pizz	1266	Piccolo Tp pp Of	Brass	Solo
1027	OrchStrgs Med L-	Strng	Ensem	1107	Tremolo Strings L-	Strng	Ensem	1187	Live Pizzct Hard L+	Strng	Pizz	1267	Piccolo Tp p	Brass	Solo
1028	OrchStrgs Med R	Strng	Ensem	1108	Tremolo Strings R-	Strng	Ensem	1188	Live Pizzct Hard R+	Strng	Pizz	1268	Piccolo Tp p Of	Brass	Solo
1029	OrchStrgs Med R+	Strng	Ensem	1109	Tremolo StringsSt Of	Strng	Ensem	1189	Live Pizzct Hard St-	Strng	Pizz	1269	Piccolo Tp mp	Brass	Solo
1030	OrchStrgs Med R-	Strng	Ensem	1110	Tremolo Strings L Of	Strng	Ensem	1190	Live Pizzct Hard L-	Strng	Pizz	1270	Piccolo Tp mp Of	Brass	Solo
1031	OrchStrgs Med St Of	Strng	Ensem	1111	Tremolo Strings R Of	Strng	Ensem	1191	Live Pizzct Hard R-	Strng	Pizz	1271	Piccolo Tp mf	Brass	Solo
1032	OrchStrgs Med L Of	Strng	Ensem	1112	US Strings p St	Strng	Ensem	1192	Orchestral Harp1	Strng	Pizz	1272	Piccolo Tp mf Of	Brass	Solo
1033	OrchStrgs Med R Of	Strng	Ensem	1113	US Strings p St Of	Strng	Ensem	1193	Orch Harp2 Soft St	Strng	Pizz	1273	Piccolo Tp f	Brass	Solo
1034	OrchStrgs Hard St	Strng	Ensem	1114	US Strings mf St	Strng	Ensem	1194	Orch Harp2 Soft L	Strng	Pizz	1274	Piccolo Tp f Of	Brass	Solo
1035	OrchStrgs Hard St+	Strng	Ensem	1115	US Strings mf St Of	Strng	Ensem	1195	Orch Harp2 Soft R	Strng	Pizz	1275	Piccolo Tp Sw	Brass	Solo
1036	OrchStrgs Hard St-	Strng	Ensem	1116	US Strings f St	Strng	Ensem	1196	Orch Harp2 Soft St+	Strng	Pizz	1276	Piccolo Tp Sw Of	Brass	Solo
1037	OrchStrgs Hard L	Strng	Ensem	1117	US Strings f St Of	Strng	Ensem	1197	Orch Harp2 Soft L+	Strng	Pizz	1277	Trombone1	Brass	Solo
1038	OrchStrgs Hard L+	Strng	Ensem	1118	US Strings Sw St	Strng	Ensem	1198	Orch Harp2 Soft R+	Strng	Pizz	1278	Trombone1-	Brass	Solo
1039	OrchStrgs Hard L-	Strng	Ensem	1119	US Strings Sw St Of	Strng	Ensem	1199	Orch Harp2 Soft St-	Strng	Pizz	1279	Trombone1 Of	Brass	Solo
1040	OrchStrgs Hard R	Strng	Ensem	1120	US Strings Spic St	Strng	Ensem	1200	Orch Harp2 Soft L-	Strng	Pizz	1280	Trombone1- Of	Brass	Solo

No.	Name	Main Category	Sub Category	No.	Name	Main Category	Sub Category	No.	Name	Main Category	Sub Category	No.	Name	Main Category	Sub Category
1281	Trombone2	Brass	Solo	1361	Brass Sect1 St+ Of	Brass	Ensem	1441	FrHorns1 Str L	Brass	Ensem	1521	Tenor Sax2 Growl+	SaxWW	Sax
1282	Trombone2 Of	Brass	Solo	1362	Brass Sect1 St- Of	Brass	Ensem	1442	FrHorns1 Str R	Brass	Ensem	1522	Tenor Sax2 Growl-	SaxWW	Sax
1283	Trombone3 p	Brass	Solo	1363	Brass Sect1 L Of	Brass	Ensem	1443	FrHorns1 Str St+	Brass	Ensem	1523	Tenor Sax2 Growl Of	SaxWW	Sax
1284	Trombone3 p Of	Brass	Solo	1364	Brass Sect1 L+ Of	Brass	Ensem	1444	FrHorns1 Str L+	Brass	Ensem	1524	Tenor Sax2 Falls	SaxWW	Sax
1285	Trombone3 mp	Brass	Solo	1365	Brass Sect1 L- Of	Brass	Ensem	1445	FrHorns1 Str R+	Brass	Ensem	1525	Tenor Sax2 Falls+	SaxWW	Sax
1286	Trombone3 mp Of	Brass	Solo	1366	Brass Sect1 R Of	Brass	Ensem	1446	FrHorns1 Str St-	Brass	Ensem	1526	Tenor Sax2 Falls-	SaxWW	Sax
1287	Trombone3 mf	Brass	Solo	1367	Brass Sect1 R+ Of	Brass	Ensem	1447	FrHorns1 Str L-	Brass	Ensem	1527	Baritone Sax	SaxWW	Sax
1288	Trombone3 mf Of	Brass	Solo	1368	Brass Sect1 R- Of	Brass	Ensem	1448	FrHorns1 Str R-	Brass	Ensem	1528	Baritone Sax Of	SaxWW	Sax
1289	Trombone3 f	Brass	Solo	1369	Brass Sect Fall	Brass	Ensem	1449	FrHorns1 Str St Of	Brass	Ensem	1529	Sax Breath	SaxWW	Sax
1290	Trombone3 f Of	Brass	Solo	1370	Brass Sect2 Soft St	Brass	Ensem	1450	FrHorns1 Str L Of	Brass	Ensem	1530	Clarinet1 Soft St	SaxWW	Orche
1291	Trombone3 ff	Brass	Solo	1371	Brass Sect2 Soft St+	Brass	Ensem	1451	FrHorns1 Str R Of	Brass	Ensem	1531	Clarinet1 Soft St+	SaxWW	Orche
1292	Trombone3 ff Of	Brass	Solo	1372	Brass Sect2 Soft St-	Brass	Ensem	1452	FrHorns1 Str St+ Of	Brass	Ensem	1532	Clarinet1 Soft St-	SaxWW	Orche
1293	Trombone3 Sw	Brass	Solo	1373	Brass Sect2 Soft L	Brass	Ensem	1453	FrHorns1 Str L+ Of	Brass	Ensem	1533	Clarinet1 Soft L	SaxWW	Orche
1294	Trombone3 Sw Of	Brass	Solo	1374	Brass Sect2 Soft L+	Brass	Ensem	1454	FrHorns1 Str R- Of	Brass	Ensem	1534	Clarinet1 Soft L+	SaxWW	Orche
1295	Soft Trombone	Brass	Solo	1375	Brass Sect2 Soft L-	Brass	Ensem	1455	FrHorns1 Str St- Of	Brass	Ensem	1535	Clarinet1 Soft L-	SaxWW	Orche
1296	Soft Trombone Of	Brass	Solo	1376	Brass Sect2 Soft R	Brass	Ensem	1456	FrHorns1 Str L- Of	Brass	Ensem	1536	Clarinet1 Soft R	SaxWW	Orche
1297	Bass Trombone mp	Brass	Solo	1377	Brass Sect2 Soft R+	Brass	Ensem	1457	FrHorns1 Str R- Of	Brass	Ensem	1537	Clarinet1 Soft R+	SaxWW	Orche
1298	Bass Trombone mp Of	Brass	Solo	1378	Brass Sect2 Soft R-	Brass	Ensem	1458	FrHorns1 Med St	Brass	Ensem	1538	Clarinet1 Soft R-	SaxWW	Orche
1299	Bass Trombone mf	Brass	Solo	1379	Brass Sect2 SoftSIOf	Brass	Ensem	1459	FrHorns1 Med L	Brass	Ensem	1539	Clarinet1 Soft St Of	SaxWW	Orche
1300	Bass Trombone mf Of	Brass	Solo	1380	Brass Sect2 Soft LOf	Brass	Ensem	1460	FrHorns1 Med R	Brass	Ensem	1540	Clarinet1 Soft L Of	SaxWW	Orche
1301	Bass Trombone f	Brass	Solo	1381	Brass Sect2 Soft ROf	Brass	Ensem	1461	FrHorns1 Med St+	Brass	Ensem	1541	Clarinet1 Soft R Of	SaxWW	Orche
1302	Bass Trombone f Of	Brass	Solo	1382	Brass Sect2 Med St	Brass	Ensem	1462	FrHorns1 Med L+	Brass	Ensem	1542	Clarinet1 Med St	SaxWW	Orche
1303	Bass Trombone ff	Brass	Solo	1383	Brass Sect2 Med St+	Brass	Ensem	1463	FrHorns1 Med R+	Brass	Ensem	1543	Clarinet1 Med St+	SaxWW	Orche
1304	Bass Trombone ff Of	Brass	Solo	1384	Brass Sect2 Med St-	Brass	Ensem	1464	FrHorns1 Med St-	Brass	Ensem	1544	Clarinet1 Med St-	SaxWW	Orche
1305	Bass Trombone fff	Brass	Solo	1385	Brass Sect2 Med L	Brass	Ensem	1465	FrHorns1 Med L-	Brass	Ensem	1545	Clarinet1 Med L	SaxWW	Orche
1306	Bass Trombone fff Of	Brass	Solo	1386	Brass Sect2 Med L+	Brass	Ensem	1466	FrHorns1 Med R-	Brass	Ensem	1546	Clarinet1 Med L+	SaxWW	Orche
1307	Bass Trombone Sw	Brass	Solo	1387	Brass Sect2 Med L-	Brass	Ensem	1467	FrHorns1 Med St Of	Brass	Ensem	1547	Clarinet1 Med L-	SaxWW	Orche
1308	Bass Trombone Sw Of	Brass	Solo	1388	Brass Sect2 Med R	Brass	Ensem	1468	FrHorns1 Med L Of	Brass	Ensem	1548	Clarinet1 Med R	SaxWW	Orche
1309	Soft Flugelhorn	Brass	Solo	1389	Brass Sect2 Med R+	Brass	Ensem	1469	FrHorns1 Med R Of	Brass	Ensem	1549	Clarinet1 Med R+	SaxWW	Orche
1310	Soft Flugelhorn-	Brass	Solo	1390	Brass Sect2 Med R-	Brass	Ensem	1470	FrHorns1 Med St+ Of	Brass	Ensem	1550	Clarinet1 Med R-	SaxWW	Orche
1311	Soft Flugelhorn Of	Brass	Solo	1391	Brass Sect2 Med SIOf	Brass	Ensem	1471	FrHorns1 Med L+ Of	Brass	Ensem	1551	Clarinet1 Med St Of	SaxWW	Orche
1312	Soft Flugelhorn- Of	Brass	Solo	1392	Brass Sect2 Med L Of	Brass	Ensem	1472	FrHorns1 Med R+ Of	Brass	Ensem	1552	Clarinet1 Med L Of	SaxWW	Orche
1313	Flugelhorn1	Brass	Solo	1393	Brass Sect2 Med R Of	Brass	Ensem	1473	FrHorns1 Med St- Of	Brass	Ensem	1553	Clarinet1 Med R Of	SaxWW	Orche
1314	Flugelhorn1 Of	Brass	Solo	1394	Brass Sect2 Hard St	Brass	Ensem	1474	FrHorns1 Med L- Of	Brass	Ensem	1554	Clarinet1 Hard St	SaxWW	Orche
1315	Flugelhorn2	Brass	Solo	1395	Brass Sect2 Hard St+	Brass	Ensem	1475	FrHorns1 Med R- Of	Brass	Ensem	1555	Clarinet1 Hard St+	SaxWW	Orche
1316	Flugelhorn2+	Brass	Solo	1396	Brass Sect2 Hard St-	Brass	Ensem	1476	FrHorns2 p St	Brass	Ensem	1556	Clarinet1 Hard St-	SaxWW	Orche
1317	Flugelhorn2-	Brass	Solo	1397	Brass Sect2 Hard L	Brass	Ensem	1477	FrHorns2 mp St	Brass	Ensem	1557	Clarinet1 Hard L	SaxWW	Orche
1318	Flugelhorn2 Of	Brass	Solo	1398	Brass Sect2 Hard L+	Brass	Ensem	1478	FrHorns2 mf St	Brass	Ensem	1558	Clarinet1 Hard L+	SaxWW	Orche
1319	French Horn1	Brass	Solo	1399	Brass Sect2 Hard L-	Brass	Ensem	1479	FrHorns2 f St	Brass	Ensem	1559	Clarinet1 Hard L-	SaxWW	Orche
1320	French Horn1+	Brass	Solo	1400	Brass Sect2 Hard R	Brass	Ensem	1480	FrHorns2 ff St	Brass	Ensem	1560	Clarinet1 Hard R	SaxWW	Orche
1321	French Horn1-	Brass	Solo	1401	Brass Sect2 Hard R+	Brass	Ensem	1481	FrHorns2 5Sw St	Brass	Ensem	1561	Clarinet1 Hard R+	SaxWW	Orche
1322	French Horn1 Of	Brass	Solo	1402	Brass Sect2 Hard R-	Brass	Ensem	1482	FrHorns2 4Sw St	Brass	Ensem	1562	Clarinet1 Hard R-	SaxWW	Orche
1323	French Horn1+ Of	Brass	Solo	1403	Brass Sect2 Hrd SIOf	Brass	Ensem	1483	FrHorns3 p St	Brass	Ensem	1563	Clarinet1 Hard St Of	SaxWW	Orche
1324	French Horn1- Of	Brass	Solo	1404	Brass Sect2 Hrd L Of	Brass	Ensem	1484	FrHorns3 mp St	Brass	Ensem	1564	Clarinet1 Hard L Of	SaxWW	Orche
1325	French Horn2 mp	Brass	Solo	1405	Brass Sect2 Hrd R Of	Brass	Ensem	1485	FrHorns3 mf St	Brass	Ensem	1565	Clarinet1 Hard R Of	SaxWW	Orche
1326	French Horn2 mp Of	Brass	Solo	1406	BrassSect3 Acc p	Brass	Ensem	1486	FrHorns3 f St	Brass	Ensem	1566	Clarinet2 pp St	SaxWW	Orche
1327	French Horn2 mf	Brass	Solo	1407	BrassSect3 Acc p Of	Brass	Ensem	1487	FrHorns3 Sw St	Brass	Ensem	1567	Clarinet2 pp St Of	SaxWW	Orche
1328	French Horn2 mf Of	Brass	Solo	1408	BrassSect3 Acc mp	Brass	Ensem	1488	Soprano Sax1	SaxWW	Sax	1568	Clarinet2 mp St	SaxWW	Orche
1329	French Horn2 f	Brass	Solo	1409	BrassSect3 Acc mp Of	Brass	Ensem	1489	Soprano Sax1 Of	SaxWW	Sax	1569	Clarinet2 mp St Of	SaxWW	Orche
1330	French Horn2 f Of	Brass	Solo	1410	BrassSect3 Acc mf	Brass	Ensem	1490	Soprano Sax2	SaxWW	Sax	1570	Clarinet2 mf St	SaxWW	Orche
1331	French Horn2 ff	Brass	Solo	1411	BrassSect3 Acc mf Of	Brass	Ensem	1491	Soprano Sax2 Of	SaxWW	Sax	1571	Clarinet2 mf St Of	SaxWW	Orche
1332	French Horn2 fff	Brass	Solo	1412	BrassSect3 Sus ff	Brass	Ensem	1492	Soprano Sax3	SaxWW	Sax	1572	Clarinet2 ff St	SaxWW	Orche
1333	French Horn2 fff Of	Brass	Solo	1413	BrassSect3 Dolts	Brass	Ensem	1493	Soprano Sax3+	SaxWW	Sax	1573	Clarinet2 ff St Of	SaxWW	Orche
1334	French Horn2 fff Of	Brass	Solo	1414	BrassSect3 Shake	Brass	Ensem	1494	Soprano Sax3-	SaxWW	Sax	1574	Clarinet2 ff St Of	SaxWW	Orche
1335	French Horn2 Sw	Brass	Solo	1415	BrassSect3 Fall	Brass	Ensem	1495	Soprano Sax3 Of	SaxWW	Sax	1575	Clarinet2 Sw St Of	SaxWW	Orche
1336	French Horn2 Sw Of	Brass	Solo	1416	Trumpets1 pp St	Brass	Ensem	1496	Alto Sax1	SaxWW	Sax	1576	Clarinet3 pp St	SaxWW	Orche
1337	Euphonium p St	Brass	Solo	1417	Trumpets1 mp St	Brass	Ensem	1497	Alto Sax1 Of	SaxWW	Sax	1577	Clarinet3 pp St Of	SaxWW	Orche
1338	Euphonium p St Of	Brass	Solo	1418	Trumpets1 mf St	Brass	Ensem	1498	Alto Sax2	SaxWW	Sax	1578	Clarinet3 pp St Of	SaxWW	Orche
1339	Euphonium mp St	Brass	Solo	1419	Trumpets1 f St	Brass	Ensem	1499	Alto Sax2 Of	SaxWW	Sax	1579	Clarinet3 mp St Of	SaxWW	Orche
1340	Euphonium mp St Of	Brass	Solo	1420	Trumpets1 ff St	Brass	Ensem	1500	Alto Sax Vb	SaxWW	Sax	1580	Clarinet3 mf St	SaxWW	Orche
1341	Euphonium mf St	Brass	Solo	1421	Trumpets1 5Sw St	Brass	Ensem	1501	Alto Sax Vb Of	SaxWW	Sax	1581	Clarinet3 mf St Of	SaxWW	Orche
1342	Euphonium mf St Of	Brass	Solo	1422	Trumpets1 4Sw St	Brass	Ensem	1502	Alto Sax3	SaxWW	Sax	1582	Clarinet3 ff St	SaxWW	Orche
1343	Euphonium f St	Brass	Solo	1423	Trumpets2 pp St	Brass	Ensem	1503	Alto Sax3+	SaxWW	Sax	1583	Clarinet3 ff St Of	SaxWW	Orche
1344	Euphonium f St Of	Brass	Solo	1424	Trumpets2 mp St	Brass	Ensem	1504	Alto Sax3-	SaxWW	Sax	1584	Clarinet3 Sw St	SaxWW	Orche
1345	Euphonium ff St	Brass	Solo	1425	Trumpets2 mf St	Brass	Ensem	1505	Alto Sax3 Of	SaxWW	Sax	1585	Clarinet3 Sw St Of	SaxWW	Orche
1346	Euphonium ff St Of	Brass	Solo	1426	Trumpets2 ff St	Brass	Ensem	1506	Tenor Sax1	SaxWW	Sax	1586	Clarinet3 Stac pp St	SaxWW	Orche
1347	Euphonium Sw St	Brass	Solo	1427	Trumpets2 Sw St	Brass	Ensem	1507	Tenor Sax1 Of	SaxWW	Sax	1587	Clarinet3 Stac mp St	SaxWW	Orche
1348	Euphonium Sw St Of	Brass	Solo	1428	Trombones1 pp St	Brass	Ensem	1508	Tenor Sax2 Soft	SaxWW	Sax	1588	Clarinet3 Stac mf St	SaxWW	Orche
1349	Tuba	Brass	Solo	1429	Trombones1 mp St	Brass	Ensem	1509	Tenor Sax2 Soft+	SaxWW	Sax	1589	Clarinet3 Stac ff St	SaxWW	Orche
1350	Tuba Lp	Brass	Solo	1430	Trombones1 mf St	Brass	Ensem	1510	Tenor Sax2 Soft-	SaxWW	Sax	1590	Clarinet3 Stac Sw St	SaxWW	Orche
1351	Brass Sect1 St	Brass	Ensem	1431	Trombones1 f St	Brass	Ensem	1511	Tenor Sax2 Soft Of	SaxWW	Sax	1591	Oboe1	SaxWW	Orche
1352	Brass Sect1 St+	Brass	Ensem	1432	Trombones1 ff St	Brass	Ensem	1512	Tenor Sax2 Med+	SaxWW	Sax	1592	Oboe1 Of	SaxWW	Orche
1353	Brass Sect1 St-	Brass	Ensem	1433	Trombones1 5Sw St	Brass	Ensem	1513	Tenor Sax2 Med-	SaxWW	Sax	1593	Oboe2 Med St	SaxWW	Orche
1354	Brass Sect1 L	Brass	Ensem	1434	Trombones1 4Sw St	Brass	Ensem	1514	Tenor Sax2 Med-	SaxWW	Sax	1594	Oboe2 Med St+	SaxWW	Orche
1355	Brass Sect1 L+	Brass	Ensem	1435	Trombones2 pp St	Brass	Ensem	1515	Tenor Sax2 Med Of	SaxWW	Sax	1595	Oboe2 Med St-	SaxWW	Orche
1356	Brass Sect1 L-	Brass	Ensem	1436	Trombones2 mp St	Brass	Ensem	1516	Tenor Sax2 Hard	SaxWW	Sax	1596	Oboe2 Med L	SaxWW	Orche
1357	Brass Sect1 R	Brass	Ensem	1437	Trombones2 mf St	Brass	Ensem	1517	Tenor Sax2 Hard+	SaxWW	Sax	1597	Oboe2 Med L+	SaxWW	Orche
1358	Brass Sect1 R+	Brass	Ensem	1438	Trombones2 ff St	Brass	Ensem	1518	Tenor Sax2 Hard-	SaxWW	Sax	1598	Oboe2 Med L-	SaxWW	Orche
1359	Brass Sect1 R-	Brass	Ensem	1439	Trombones2 Sw St	Brass	Ensem	1519	Tenor Sax2 Hard Of	SaxWW	Sax	1599	Oboe2 Med R	SaxWW	Orche
1360	Brass Sect1 St Of	Brass	Ensem	1440	FrHorns1 Str St	Brass	Ensem	1520	Tenor Sax2 Growl	SaxWW	Sax	1600	Oboe2 Med R+	SaxWW	Orche

No.	Name	Main Category	Sub Category	No.	Name	Main Category	Sub Category	No.	Name	Main Category	Sub Category	No.	Name	Main Category	Sub Category
1601	Oboe2 Med R-	SaxWW	Orche	1681	Bassoon2 mp St Of	SaxWW	Orche	1761	Flute2 Soft L	SaxWW	Orche	1841	Piccolo2 St Of	SaxWW	Orche
1602	Oboe2 Med St Of	SaxWW	Orche	1682	Bassoon2 mf St	SaxWW	Orche	1762	Flute2 Soft L+	SaxWW	Orche	1842	Piccolo2 L Of	SaxWW	Orche
1603	Oboe2 Med L Of	SaxWW	Orche	1683	Bassoon2 mf St Of	SaxWW	Orche	1763	Flute2 Soft L-	SaxWW	Orche	1843	Piccolo2 R Of	SaxWW	Orche
1604	Oboe2 Med R Of	SaxWW	Orche	1684	Bassoon2 ff St	SaxWW	Orche	1764	Flute2 Soft R	SaxWW	Orche	1844	Piccolo3 pp St	SaxWW	Orche
1605	Oboe2 Hard St	SaxWW	Orche	1685	Bassoon2 ff St Of	SaxWW	Orche	1765	Flute2 Soft R+	SaxWW	Orche	1845	Piccolo3 pp St Of	SaxWW	Orche
1606	Oboe2 Hard St+	SaxWW	Orche	1686	Bassoon2 Sw St	SaxWW	Orche	1766	Flute2 Soft R-	SaxWW	Orche	1846	Piccolo3 mp St	SaxWW	Orche
1607	Oboe2 Hard St-	SaxWW	Orche	1687	Bassoon2 Sw St Of	SaxWW	Orche	1767	Flute2 Soft St Of	SaxWW	Orche	1847	Piccolo3 mp St Of	SaxWW	Orche
1608	Oboe2 Hard L	SaxWW	Orche	1688	Bassoon3 pp St	SaxWW	Orche	1768	Flute2 Soft L Of	SaxWW	Orche	1848	Piccolo3 mf St	SaxWW	Orche
1609	Oboe2 Hard L+	SaxWW	Orche	1689	Bassoon3 pp St Of	SaxWW	Orche	1769	Flute2 Soft R Of	SaxWW	Orche	1849	Piccolo3 mf St Of	SaxWW	Orche
1610	Oboe2 Hard L-	SaxWW	Orche	1690	Bassoon3 mp St	SaxWW	Orche	1770	Flute2 Med St	SaxWW	Orche	1850	Piccolo3 ff St	SaxWW	Orche
1611	Oboe2 Hard R	SaxWW	Orche	1691	Bassoon3 mp St Of	SaxWW	Orche	1771	Flute2 Med St+	SaxWW	Orche	1851	Piccolo3 ff St Of	SaxWW	Orche
1612	Oboe2 Hard R+	SaxWW	Orche	1692	Bassoon3 mf St	SaxWW	Orche	1772	Flute2 Med St-	SaxWW	Orche	1852	Piccolo3 Sw St	SaxWW	Orche
1613	Oboe2 Hard R-	SaxWW	Orche	1693	Bassoon3 mf St Of	SaxWW	Orche	1773	Flute2 Med L	SaxWW	Orche	1853	Piccolo3 Sw St Of	SaxWW	Orche
1614	Oboe2 Hard St Of	SaxWW	Orche	1694	Bassoon3 ff St	SaxWW	Orche	1774	Flute2 Med L+	SaxWW	Orche	1854	Piccolo4 pp St	SaxWW	Orche
1615	Oboe2 Hard L Of	SaxWW	Orche	1695	Bassoon3 ff St Of	SaxWW	Orche	1775	Flute2 Med L-	SaxWW	Orche	1855	Piccolo4 pp St Of	SaxWW	Orche
1616	Oboe2 Hard R Of	SaxWW	Orche	1696	Bassoon3 Sw St	SaxWW	Orche	1776	Flute2 Med R	SaxWW	Orche	1856	Piccolo4 mp St	SaxWW	Orche
1617	Oboe3 pp St	SaxWW	Orche	1697	Bassoon3 Sw St Of	SaxWW	Orche	1777	Flute2 Med R+	SaxWW	Orche	1857	Piccolo4 mp St Of	SaxWW	Orche
1618	Oboe3 pp St Of	SaxWW	Orche	1698	Bassoon3 NV pp St	SaxWW	Orche	1778	Flute2 Med R-	SaxWW	Orche	1858	Piccolo4 mf St	SaxWW	Orche
1619	Oboe3 mp St	SaxWW	Orche	1699	Bassoon3 NV pp St Of	SaxWW	Orche	1779	Flute2 Med St Of	SaxWW	Orche	1859	Piccolo4 mf St Of	SaxWW	Orche
1620	Oboe3 mp St Of	SaxWW	Orche	1700	Bassoon3 NV mp St	SaxWW	Orche	1780	Flute2 Med L Of	SaxWW	Orche	1860	Piccolo4 ff St	SaxWW	Orche
1621	Oboe3 mf St	SaxWW	Orche	1701	Bassoon3 NV mp St Of	SaxWW	Orche	1781	Flute2 Med R Of	SaxWW	Orche	1861	Piccolo4 ff St Of	SaxWW	Orche
1622	Oboe3 mf St Of	SaxWW	Orche	1702	Bassoon3 NV mf St	SaxWW	Orche	1782	Flute2 Hard St	SaxWW	Orche	1862	Piccolo4 Sw St	SaxWW	Orche
1623	Oboe3 ff St	SaxWW	Orche	1703	Bassoon3 NV mf St Of	SaxWW	Orche	1783	Flute2 Hard St+	SaxWW	Orche	1863	Piccolo4 Sw St Of	SaxWW	Orche
1624	Oboe3 ff St Of	SaxWW	Orche	1704	Bassoon3 NV ff St	SaxWW	Orche	1784	Flute2 Hard St-	SaxWW	Orche	1864	Piccolo4 NV pp St	SaxWW	Orche
1625	Oboe3 Sw St	SaxWW	Orche	1705	Bassoon3 NV ff St Of	SaxWW	Orche	1785	Flute2 Hard L	SaxWW	Orche	1865	Piccolo4 NV pp St Of	SaxWW	Orche
1626	Oboe3 Sw St Of	SaxWW	Orche	1706	Bassoon3 NV Sw St	SaxWW	Orche	1786	Flute2 Hard L+	SaxWW	Orche	1866	Piccolo4 NV mp St	SaxWW	Orche
1627	Oboe4 pp St	SaxWW	Orche	1707	Bassoon3 NV Sw St Of	SaxWW	Orche	1787	Flute2 Hard L-	SaxWW	Orche	1867	Piccolo4 NV mp St Of	SaxWW	Orche
1628	Oboe4 pp St Of	SaxWW	Orche	1708	Bassoon3 Stac pp St	SaxWW	Orche	1788	Flute2 Hard R	SaxWW	Orche	1868	Piccolo4 NV mf St	SaxWW	Orche
1629	Oboe4 mp St	SaxWW	Orche	1709	Bassoon3 Stac mp St	SaxWW	Orche	1789	Flute2 Hard R+	SaxWW	Orche	1869	Piccolo4 NV mf St Of	SaxWW	Orche
1630	Oboe4 mp St Of	SaxWW	Orche	1710	Bassoon3 Stac mf St	SaxWW	Orche	1790	Flute2 Hard R-	SaxWW	Orche	1870	Piccolo4 NV ff St	SaxWW	Orche
1631	Oboe4 mf St	SaxWW	Orche	1711	Bassoon3 Stac ff St	SaxWW	Orche	1791	Flute2 Hard St Of	SaxWW	Orche	1871	Piccolo4 NV ff St Of	SaxWW	Orche
1632	Oboe4 mf St Of	SaxWW	Orche	1712	Bassoon3 Stac Sw St	SaxWW	Orche	1792	Flute2 Hard L Of	SaxWW	Orche	1872	Piccolo4 NV Sw St	SaxWW	Orche
1633	Oboe4 ff St	SaxWW	Orche	1713	CBassoon1 pp St	SaxWW	Orche	1793	Flute2 Hard R Of	SaxWW	Orche	1873	Piccolo4 NV Sw St Of	SaxWW	Orche
1634	Oboe4 ff St Of	SaxWW	Orche	1714	CBassoon1 pp Of	SaxWW	Orche	1794	Flute3 pp St	SaxWW	Orche	1874	Piccolo4 Stac pp St	SaxWW	Orche
1635	Oboe4 Sw St	SaxWW	Orche	1715	CBassoon1 mp St	SaxWW	Orche	1795	Flute3 pp St Of	SaxWW	Orche	1875	Piccolo4 Stac mp St	SaxWW	Orche
1636	Oboe4 Sw St Of	SaxWW	Orche	1716	CBassoon1 mp Of	SaxWW	Orche	1796	Flute3 mp St	SaxWW	Orche	1876	Piccolo4 Stac mf St	SaxWW	Orche
1637	Oboe4 NV pp St	SaxWW	Orche	1717	CBassoon1 mf St	SaxWW	Orche	1797	Flute3 mp St Of	SaxWW	Orche	1877	Piccolo4 Stac ff St	SaxWW	Orche
1638	Oboe4 NV pp St Of	SaxWW	Orche	1718	CBassoon1 mf Of	SaxWW	Orche	1798	Flute3 mf St	SaxWW	Orche	1878	Piccolo4 Stac Sw St	SaxWW	Orche
1639	Oboe4 NV mp St	SaxWW	Orche	1719	CBassoon1 ff St	SaxWW	Orche	1799	Flute3 mf St Of	SaxWW	Orche	1879	Breath One Shot	SaxWW	Orche
1640	Oboe4 NV mp St Of	SaxWW	Orche	1720	CBassoon1 ff Of	SaxWW	Orche	1800	Flute3 ff St	SaxWW	Orche	1880	Pan Flute	Ethnc	Blown
1641	Oboe4 NV mf St	SaxWW	Orche	1721	CBassoon1 Sw St	SaxWW	Orche	1801	Flute3 ff St Of	SaxWW	Orche	1881	Pan Flute-	Ethnc	Blown
1642	Oboe4 NV mf St Of	SaxWW	Orche	1722	CBassoon1 Sw Of	SaxWW	Orche	1802	Flute3 Sw St	SaxWW	Orche	1882	Irish Pipe	Ethnc	Blown
1643	Oboe4 NV ff St	SaxWW	Orche	1723	CBassoon2 pp St	SaxWW	Orche	1803	Flute3 Sw St Of	SaxWW	Orche	1883	Irish Pipe Of	Ethnc	Blown
1644	Oboe4 NV ff St Of	SaxWW	Orche	1724	CBassoon2 pp Of	SaxWW	Orche	1804	Flute4 pp St	SaxWW	Orche	1884	LowWhistle Sft Vb	Ethnc	Blown
1645	Oboe4 NV Sw St	SaxWW	Orche	1725	CBassoon2 mp St	SaxWW	Orche	1805	Flute4 pp St Of	SaxWW	Orche	1885	LowWhistle Sft Vb Of	Ethnc	Blown
1646	Oboe4 NV Sw St Of	SaxWW	Orche	1726	CBassoon2 mp Of	SaxWW	Orche	1806	Flute4 mp St	SaxWW	Orche	1886	LowWhistle Hrd Vb	Ethnc	Blown
1647	Oboe4 Stac pp St	SaxWW	Orche	1727	CBassoon2 mf St	SaxWW	Orche	1807	Flute4 mp St Of	SaxWW	Orche	1887	LowWhistle Hrd Vb Of	Ethnc	Blown
1648	Oboe4 Stac mp St	SaxWW	Orche	1728	CBassoon2 mf Of	SaxWW	Orche	1808	Flute4 mf St	SaxWW	Orche	1888	LowWhistle Sft	Ethnc	Blown
1649	Oboe4 Stac mf St	SaxWW	Orche	1729	CBassoon2 ff St	SaxWW	Orche	1809	Flute4 mf St Of	SaxWW	Orche	1889	LowWhistle Sft Of	Ethnc	Blown
1650	Oboe4 Stac ff St	SaxWW	Orche	1730	CBassoon2 ff Of	SaxWW	Orche	1810	Flute4 ff St	SaxWW	Orche	1890	LowWhistle Hrd	Ethnc	Blown
1651	Oboe4 Stac Sw St	SaxWW	Orche	1731	CBassoon2 Sw St	SaxWW	Orche	1811	Flute4 ff St Of	SaxWW	Orche	1891	LowWhistle Hrd Of	Ethnc	Blown
1652	English Horn	SaxWW	Orche	1732	CBassoon2 Sw Of	SaxWW	Orche	1812	Flute4 Sw St	SaxWW	Orche	1892	LowWhistle Mordent	Ethnc	Blown
1653	English Horn Of	SaxWW	Orche	1733	CBassoon2 Vlb pp St	SaxWW	Orche	1813	Flute4 Sw St Of	SaxWW	Orche	1893	LowWhistle Grace	Ethnc	Blown
1654	Bassoon1 Med St	SaxWW	Orche	1734	CBassoon2 Vlb pp Of	SaxWW	Orche	1814	Flute4 NV pp St	SaxWW	Orche	1894	LowWhistle KeyNoise	Ethnc	Blown
1655	Bassoon1 Med St+	SaxWW	Orche	1735	CBassoon2 Vlb mp St	SaxWW	Orche	1815	Flute4 NV pp St Of	SaxWW	Orche	1895	LowWhistle KeyOf	Ethnc	Blown
1656	Bassoon1 Med St-	SaxWW	Orche	1736	CBassoon2 Vlb mp Of	SaxWW	Orche	1816	Flute4 NV mp St	SaxWW	Orche	1896	HighWhistle Sft	Ethnc	Blown
1657	Bassoon1 Med L	SaxWW	Orche	1737	CBassoon2 Vlb mf St	SaxWW	Orche	1817	Flute4 NV mp St Of	SaxWW	Orche	1897	HighWhistle Sft Of	Ethnc	Blown
1658	Bassoon1 Med L+	SaxWW	Orche	1738	CBassoon2 Vlb mf Of	SaxWW	Orche	1818	Flute4 NV mf St	SaxWW	Orche	1898	HighWhistle Hrd	Ethnc	Blown
1659	Bassoon1 Med L-	SaxWW	Orche	1739	CBassoon2 Vlb ff St	SaxWW	Orche	1819	Flute4 NV mf St Of	SaxWW	Orche	1899	HighWhistle Hrd Of	Ethnc	Blown
1660	Bassoon1 Med R	SaxWW	Orche	1740	CBassoon2 Vlb ff Of	SaxWW	Orche	1820	Flute4 NV ff St	SaxWW	Orche	1900	HighWhistle OctDispl	Ethnc	Blown
1661	Bassoon1 Med R+	SaxWW	Orche	1741	CBassoon2 Vlb Sw St	SaxWW	Orche	1821	Flute4 NV ff St Of	SaxWW	Orche	1901	HighWhistle KeyNoise	Ethnc	Blown
1662	Bassoon1 Med R-	SaxWW	Orche	1742	CBassoon2 Vlb Sw Of	SaxWW	Orche	1822	Flute4 NV Sw St	SaxWW	Orche	1902	Shakuhachi	Ethnc	Blown
1663	Bassoon1 Med St Of	SaxWW	Orche	1743	CBassoon2 Stac pp St	SaxWW	Orche	1823	Flute4 NV Sw St Of	SaxWW	Orche	1903	Shakuhachi Of	Ethnc	Blown
1664	Bassoon1 Med L Of	SaxWW	Orche	1744	CBassoon2 Stac mp St	SaxWW	Orche	1824	Flute4 Stac pp St	SaxWW	Orche	1904	Recorder	SaxWW	Other
1665	Bassoon1 Med R Of	SaxWW	Orche	1745	CBassoon2 Stac mf St	SaxWW	Orche	1825	Flute4 Stac mp St	SaxWW	Orche	1905	Recorder Of	SaxWW	Other
1666	Bassoon1 Hard St	SaxWW	Orche	1746	CBassoon2 Stac ff St	SaxWW	Orche	1826	Flute4 Stac mf St	SaxWW	Orche	1906	Bottle	SaxWW	Other
1667	Bassoon1 Hard St+	SaxWW	Orche	1747	CBassoon2 Stac ff Of	SaxWW	Orche	1827	Flute4 Stac ff St	SaxWW	Orche	1907	Ocarina	SaxWW	Other
1668	Bassoon1 Hard St-	SaxWW	Orche	1748	Bagpipe1	SaxWW	Other	1828	Flute4 Stac Sw St	SaxWW	Orche	1908	Ocarina Of	SaxWW	Other
1669	Bassoon1 Hard L	SaxWW	Orche	1749	Bagpipe2	SaxWW	Other	1829	Flute4 Flutter St	SaxWW	Orche	1909	Human Whistle	SaxWW	Other
1670	Bassoon1 Hard L+	SaxWW	Orche	1750	Harmonica	SaxWW	Other	1830	Piccolo1	SaxWW	Orche	1910	Didgeridoo 1	Ethnc	Blown
1671	Bassoon1 Hard L-	SaxWW	Orche	1751	Chromatic Harmonica	SaxWW	Other	1831	Piccolo1 Of	SaxWW	Orche	1911	Didgeridoo 2	Ethnc	Blown
1672	Bassoon1 Hard R	SaxWW	Orche	1752	Blues Harmonica	SaxWW	Other	1832	Piccolo2 St	SaxWW	Orche	1912	Didgeridoo 3	Ethnc	Blown
1673	Bassoon1 Hard R+	SaxWW	Orche	1753	Flute Non-Vib	SaxWW	Orche	1833	Piccolo2 L	SaxWW	Orche	1913	Didgeridoo Comb1	Ethnc	Blown
1674	Bassoon1 Hard R-	SaxWW	Orche	1754	Flute Non-Vib Of	SaxWW	Orche	1834	Piccolo2 R	SaxWW	Orche	1914	Didgeridoo Comb2	Ethnc	Blown
1675	Bassoon1 Hard St Of	SaxWW	Orche	1755	Flute1	SaxWW	Orche	1835	Piccolo2 St+	SaxWW	Orche	1915	Sho	Ethnc	Blown
1676	Bassoon1 Hard L Of	SaxWW	Orche	1756	Flute1 Of	SaxWW	Orche	1836	Piccolo2 L+	SaxWW	Orche	1916	Shani	Ethnc	Blown
1677	Bassoon1 Hard R Of	SaxWW	Orche	1757	Flute1 Attack	SaxWW	Orche	1837	Piccolo2 R+	SaxWW	Orche	1917	Shani Of	Ethnc	Blown
1678	Bassoon2 pp St	SaxWW	Orche	1758	Flute2 Soft St	SaxWW	Orche	1838	Piccolo2 St-	SaxWW	Orche	1918	Ney	Ethnc	Blown
1679	Bassoon2 pp St Of	SaxWW	Orche	1759	Flute2 Soft St+	SaxWW	Orche	1839	Piccolo2 L-	SaxWW	Orche	1919	Ney Of	Ethnc	Blown
1680	Bassoon2 mp St	SaxWW	Orche	1760	Flute2 Soft St-	SaxWW	Orche	1840	Piccolo2 R-	SaxWW	Orche	1920	Kaval	Ethnc	Blown

No.	Name	Main Category	Sub Category	No.	Name	Main Category	Sub Category	No.	Name	Main Category	Sub Category	No.	Name	Main Category	Sub Category
1921	Kaval Of	Ethnc	Blown	2001	Vocal Breathing	Pads	Voice	2081	Trance St	Pads	Other	2161	Digi 04	SynLd	Digi
1922	Hah Choir St	Pads	Voice	2002	F Bah Soft -12	Pads	Voice	2082	Trance Mn	Pads	Other	2162	Digi 05	SynLd	Digi
1923	Hah Choir L	Pads	Voice	2003	F Bah Loud -12	Pads	Voice	2083	PWM Fast	Pads	Other	2163	Digi 06	SynLd	Digi
1924	Hah Choir R	Pads	Voice	2004	F Hah Soft -12	Pads	Voice	2084	PWM Slow	Pads	Other	2164	Digi 07	SynLd	Digi
1925	Ooh Choir St	Pads	Voice	2005	F Hah Loud -12	Pads	Voice	2085	CS80 Brass	Pads	Brass	2165	Digi 08	SynLd	Digi
1926	Ooh Choir L	Pads	Voice	2006	F Yah Soft -12	Pads	Voice	2086	Airy Sine	Pads	Other	2166	Digi 09	SynLd	Digi
1927	Ooh Choir R	Pads	Voice	2007	F Huh Soft -12	Pads	Voice	2087	String Machine	Pads	Str	2167	Digi 10	SynLd	Digi
1928	Ooh St	Pads	Voice	2008	F Huh Loud -12	Pads	Voice	2088	String Machine+	Pads	Str	2168	Digi 11	SynLd	Digi
1929	Ooh L	Pads	Voice	2009	F Huh Vib Soft -12	Pads	Voice	2089	String Machine-	Pads	Str	2169	Digi 12	SynLd	Digi
1930	Ooh R	Pads	Voice	2010	F Huh Vib Loud -12	Pads	Voice	2090	Med Detuned Pad St	Pads	Other	2170	Bell1 Wave	SynLd	Digi
1931	Ooh St Of	Pads	Voice	2011	F Dooh Soft -12	Pads	Voice	2091	Med Detuned Pad L	Pads	Other	2171	Bell2 Wave	SynLd	Digi
1932	Ooh L Of	Pads	Voice	2012	F Dooh Loud -12	Pads	Voice	2092	Med Detuned Pad R	Pads	Other	2172	DigiVox1	SynLd	Voice
1933	Ooh R Of	Pads	Voice	2013	F Shoo Soft -12	Pads	Voice	2093	StrongDetuned Pad St	Pads	Other	2173	DigiVox2	SynLd	Voice
1934	Cho Breath L	Pads	Voice	2014	F Whee -12	Pads	Voice	2094	StrongDetuned Pad L	Pads	Other	2174	DigiVox3	SynLd	Voice
1935	Cho Breath R	Pads	Voice	2015	F Eeh Vib -12	Pads	Voice	2095	StrongDetuned Pad R	Pads	Other	2175	DigiVox4	SynLd	Voice
1936	Syn Vox	Pads	Voice	2016	F Bee -12	Pads	Voice	2096	Med Detuned 3osc	Pads	Other	2176	DigiVox5	SynLd	Voice
1937	Vox Noise	Pads	Voice	2017	F Dah Soft -12	Pads	Voice	2097	XP Brass	Pads	Brass	2177	Vox G2	SynLd	Voice
1938	Itopia	Pads	Voice	2018	F Dah Loud -12	Pads	Voice	2098	XP Brass Lp	Pads	Brass	2178	Vox E3	SynLd	Voice
1939	Granu Vox	Pads	Voice	2019	Bah Soft Split	Pads	Voice	2099	String Pad St	Pads	Str	2179	DigiOsc1	SynLd	Digi
1940	Day	Pads	Voice	2020	Bah Vib Loud Split	Pads	Voice	2100	String Pad L	Pads	Str	2180	DigiOsc2	SynLd	Digi
1941	So Long	Pads	Voice	2021	Hah Soft Split	Pads	Voice	2101	String Pad R	Pads	Str	2181	DigiOsc3	SynLd	Digi
1942	Vocal Osc	Pads	Voice	2022	Hah Loud Split	Pads	Voice	2102	OB Brassy Pad St	Pads	Brass	2182	DigiOsc4	SynLd	Digi
1943	Boys Choir Oh p	Pads	Voice	2023	Yah Soft Split	Pads	Voice	2103	OB Brassy Pad L	Pads	Brass	2183	DigiOsc5	SynLd	Digi
1944	Boys Choir Oh mf	Pads	Voice	2024	Huh Soft Split	Pads	Voice	2104	OB Brassy Pad R	Pads	Brass	2184	DigiOsc6	SynLd	Digi
1945	Boys Choir Ah p	Pads	Voice	2025	Huh Loud Split	Pads	Voice	2105	Fat PWM St	Pads	Other	2185	DigiOsc7	SynLd	Digi
1946	Boys Choir Ah mf	Pads	Voice	2026	Huh Vib Soft Split	Pads	Voice	2106	Fat PWM L	Pads	Other	2186	EP Wave 1	SyCmp	Other
1947	Gospel Choir Hm f	Pads	Voice	2027	Huh Vib Loud Split	Pads	Voice	2107	Fat PWM R	Pads	Other	2187	EP Wave 2	SyCmp	Other
1948	Gospel Choir Wow f	Pads	Voice	2028	Dooh Soft Split	Pads	Voice	2108	Soft Ensemble St	Pads	Str	2188	EP Wave 3	SyCmp	Other
1949	Gospel Choir Hey f	Pads	Voice	2029	Dooh Loud Split	Pads	Voice	2109	Soft Ensemble L	Pads	Str	2189	EP Wave 4	SyCmp	Other
1950	M Bah Soft	Pads	Voice	2030	Shoo Soft Split	Pads	Voice	2110	Soft Ensemble R	Pads	Str	2190	EP Wave 5	SyCmp	Other
1951	F Bah Soft	Pads	Voice	2031	Whee Split	Pads	Voice	2111	Sync Lead1	SynLd	Analg	2191	EP Wave 6	SyCmp	Other
1952	Mix Bah Soft	Pads	Voice	2032	Eeh Vib Split	Pads	Voice	2112	Sync Lead2	SynLd	Analg	2192	Organ Wave1	Pads	Other
1953	M Bah Loud	Pads	Voice	2033	Bee Split	Pads	Voice	2113	Sync Lead3	SynLd	Analg	2193	Organ Wave2	Pads	Other
1954	F Bah Loud	Pads	Voice	2034	Dah Soft Split	Pads	Voice	2114	Sync Lead4	SynLd	Analg	2194	Organ Wave3	Pads	Other
1955	Mix Bah Loud	Pads	Voice	2035	Dah Loud Split	Pads	Voice	2115	Sync Lead5	SynLd	Analg	2195	DigiBell1	SyCmp	Other
1956	M Hah Soft	Pads	Voice	2036	ScatCycle1-1	Pads	Voice	2116	Sync LFO	SynLd	Analg	2196	DigiBell2	SyCmp	Other
1957	F Hah Soft	Pads	Voice	2037	ScatCycle1-2	Pads	Voice	2117	P5 SawDown 0 dg	SynLd	Analg	2197	DigiBell3	SyCmp	Other
1958	Mix Hah Soft	Pads	Voice	2038	ScatCycle2-1	Pads	Voice	2118	P5 SawDown 180 dg	SynLd	Analg	2198	DigiBell4	SyCmp	Other
1959	M Hah Loud	Pads	Voice	2039	ScatCycle2-2	Pads	Voice	2119	P5 SawDown PhaseRndm	SynLd	Analg	2199	DigiBell5	SyCmp	Other
1960	F Hah Loud	Pads	Voice	2040	ScatCycle3-1	Pads	Voice	2120	P5 SawUp 0 dg	SynLd	Analg	2200	DigiBell6	SyCmp	Other
1961	Mix Hah Loud	Pads	Voice	2041	ScatCycle3-2	Pads	Voice	2121	P5 SawUp 90 dg	SynLd	Analg	2201	DigiBell7	SyCmp	Other
1962	M Yah Soft	Pads	Voice	2042	ScatCycle4-1	Pads	Voice	2122	P5 SawUp 180 dg	SynLd	Analg	2202	Trance Attack St	SyCmp	Slab
1963	F Yah Soft	Pads	Voice	2043	ScatCycle4-2	Pads	Voice	2123	P5 SawUp 270 dg	SynLd	Analg	2203	Mini Short Attack	SyCmp	Slab
1964	Mix Yah Soft	Pads	Voice	2044	LatinCycle1	Pads	Voice	2124	OB Saw	SynLd	Analg	2204	VA Attacks1	SyCmp	Slab
1965	M Huh Soft	Pads	Voice	2045	LatinCycle2	Pads	Voice	2125	Saw	SynLd	Analg	2205	VA Attacks2	SyCmp	Slab
1966	F Huh Soft	Pads	Voice	2046	LatinCycle3	Pads	Voice	2126	101 Saw	SynLd	Analg	2206	Spectrum1	Pads	Other
1967	Mix Huh Soft	Pads	Voice	2047	ScatCycle Split1-1	Pads	Voice	2127	101 Sub	SynLd	Analg	2207	Spectrum2	Pads	Other
1968	M Huh Loud	Pads	Voice	2048	ScatCycle Split1-2	Pads	Voice	2128	Saw Square	SynLd	Analg	2208	Spectrum3	Pads	Other
1969	F Huh Loud	Pads	Voice	2049	ScatCycle Split2-1	Pads	Voice	2129	Square Saw	SynLd	Analg	2209	303 Saw	Bass	SynBs
1970	Mix Huh Loud	Pads	Voice	2050	ScatCycle Split2-2	Pads	Voice	2130	Mg Ramp	SynLd	Analg	2210	303 Saw2	Bass	SynBs
1971	M Huh Vib Soft	Pads	Voice	2051	ScatCycle Split3-1	Pads	Voice	2131	P10-1	SynLd	Analg	2211	303 Square	Bass	SynBs
1972	F Huh Vib Soft	Pads	Voice	2052	ScatCycle Split3-2	Pads	Voice	2132	P10-2	SynLd	Analg	2212	Mini Bass1	Bass	SynBs
1973	Mix Huh Vib Soft	Pads	Voice	2053	ScatCycle Split4-1	Pads	Voice	2133	P10-3	SynLd	Analg	2213	Mini Bass1 Of	Bass	SynBs
1974	M Huh Vib Loud	Pads	Voice	2054	ScatCycle Split4-2	Pads	Voice	2134	P25-1	SynLd	Analg	2214	Mini Bass2	Bass	SynBs
1975	F Huh Vib Loud	Pads	Voice	2055	LatinCycle Split1	Pads	Voice	2135	P25-2	SynLd	Analg	2215	Mini Bass2 Of	Bass	SynBs
1976	Mix Huh Vib Loud	Pads	Voice	2056	LatinCycle Split2	Pads	Voice	2136	P50-1	SynLd	Analg	2216	Mini Bass3a	Bass	SynBs
1977	M Dooh Soft	Pads	Voice	2057	LatinCycle Split3	Pads	Voice	2137	P50-2	SynLd	Analg	2217	Mini Bass3b	Bass	SynBs
1978	F Dooh Soft	Pads	Voice	2058	PWM Strings St	Pads	Str	2138	Tri Wave	SynLd	Analg	2218	Mini Bass3c	Bass	SynBs
1979	Mix Dooh Soft	Pads	Voice	2059	PWM Strings Mn	Pads	Str	2139	Sine	SynLd	Analg	2219	Q Synbass	Bass	SynBs
1980	M Dooh Loud	Pads	Voice	2060	Long Saw	Pads	Other	2140	Heterodyning	SynLd	Analg	2220	Q Synbass Of	Bass	SynBs
1981	F Dooh Loud	Pads	Voice	2061	Fat Saw St	Pads	Other	2141	Ring Mod	SynLd	Digi	2221	Punch	Bass	SynBs
1982	Mix Dooh Loud	Pads	Voice	2062	Fat Saw Mn	Pads	Other	2142	FM Square	SynLd	Digi	2222	Punch Of	Bass	SynBs
1983	M Shoo Soft	Pads	Voice	2063	Fat Saw Mn-	Pads	Other	2143	FM Shaper	SynLd	Digi	2223	Synth Bass1	Bass	SynBs
1984	F Shoo Soft	Pads	Voice	2064	OB Mod Saw	Pads	Other	2144	FM Metal1	SynLd	Digi	2224	Synth Bass2	Bass	SynBs
1985	Mix Shoo Soft	Pads	Voice	2065	Uni Six St	Pads	Other	2145	FM Metal2	SynLd	Digi	2225	Brip Bass	Bass	SynBs
1986	M Whee	Pads	Voice	2066	Trance ABS St	Pads	Other	2146	Formant Ring Osc	SynLd	Digi	2226	Brip Bass Of	Bass	SynBs
1987	F Whee	Pads	Voice	2067	Hyper Trance St	Pads	Other	2147	Log Spectrum1	SynLd	Digi	2227	Klick Bass	Bass	SynBs
1988	Mix Whee	Pads	Voice	2068	Phat Stack St	Pads	Other	2148	Log Spectrum2	SynLd	Digi	2228	Klick Bass Of	Bass	SynBs
1989	M Eeh Vib	Pads	Voice	2069	Saw Eight Detune St	Pads	Other	2149	FM Organ1	Pads	Other	2229	Puls Bass	Bass	SynBs
1990	F Eeh Vib	Pads	Voice	2070	Chorus Pad St	Pads	Other	2150	FM Organ2	Pads	Other	2230	Puls Bass Of	Bass	SynBs
1991	Mix Eeh Vib	Pads	Voice	2071	Dance Fat St	Pads	Other	2151	FM Organ3	Pads	Other	2231	Dirty Perc	Bass	SynBs
1992	M Bee	Pads	Voice	2072	Monster Pad St	Pads	Other	2152	FM Organ4	Pads	Other	2232	Short Uni	Bass	SynBs
1993	F Bee	Pads	Voice	2073	VP Strings St	Pads	Str	2153	FM Tubular Bass	SynLd	Digi	2233	Short Uni Of	Bass	SynBs
1994	Mix Bee	Pads	Voice	2074	VP Strings L	Pads	Str	2154	FM Funk	SynLd	Digi	2234	Noise Bass	Bass	SynBs
1995	M Dah Soft	Pads	Voice	2075	VP Strings R	Pads	Str	2155	FM Guitar	SynLd	Digi	2235	Noise Bass Of	Bass	SynBs
1996	F Dah Soft	Pads	Voice	2076	OB Strings	Pads	Str	2156	FS Buzz	SynLd	Digi	2236	Mg Bass1	Bass	SynBs
1997	Mix Dah Soft	Pads	Voice	2077	Syzzle Strings	Pads	Str	2157	Wet Plug	SynLd	Digi	2237	Mg Bass1 Of	Bass	SynBs
1998	M Dah Loud	Pads	Voice	2078	Padd	Pads	Other	2158	Digi 01	SynLd	Digi	2238	Mg Bass2	Bass	SynBs
1999	F Dah Loud	Pads	Voice	2079	Dark Light	Pads	Other	2159	Digi 02	SynLd	Digi	2239	Mg Bass2 Of	Bass	SynBs
2000	Mix Dah Loud	Pads	Voice	2080	OB Brass	Pads	Brass	2160	Digi 03	SynLd	Digi	2240	Mg Bass3	Bass	SynBs

No.	Name	Main Category	Sub Category	No.	Name	Main Category	Sub Category	No.	Name	Main Category	Sub Category	No.	Name	Main Category	Sub Category
2241	Mg Bass3 Of	Bass	SynBs	2321	Trance Choir	M.EFX	Ambie	2401	Neo Seq Em-7	M.EFX	EFX	2481	Ethnic Rhythm Rv All	S.EFX	SE
2242	Mod Bass	Bass	SynBs	2322	Eery	M.EFX	Ambie	2402	Neo Seq Em-8	M.EFX	EFX	2482	Ethnic Rhythm Rv-1	S.EFX	SE
2243	Analog Bass1	Bass	SynBs	2323	VoxAlk	M.EFX	Ambie	2403	Whisper Seq Bb	M.EFX	EFX	2483	Ethnic Rhythm Rv-2	S.EFX	SE
2244	Analog Bass1 Of	Bass	SynBs	2324	Hi-Lo	M.EFX	Ambie	2404	Whisper Seq Bb Of	M.EFX	EFX	2484	Ethnic Rhythm Rv-3	S.EFX	SE
2245	Analog Bass2	Bass	SynBs	2325	AirHose St	M.EFX	Ambie	2405	Woody Seq St	M.EFX	EFX	2485	Ethnic Rhythm Rv-4	S.EFX	SE
2246	Analog Bass2 Of	Bass	SynBs	2326	AirHose L	M.EFX	Ambie	2406	Woody Seq L	M.EFX	EFX	2486	Ethnic Rhythm Rv-5	S.EFX	SE
2247	Analog Bass3	Bass	SynBs	2327	AirHose R	M.EFX	Ambie	2407	Woody Seq R	M.EFX	EFX	2487	Ethnic Rhythm Rv-6	S.EFX	SE
2248	Analog Bass4	Bass	SynBs	2328	Space Scream	M.EFX	Ambie	2408	Neo Seq2 Em All	M.EFX	EFX	2488	Ethnic Rhythm Rv-7	S.EFX	SE
2249	Analog Bass4 Of	Bass	SynBs	2329	Ooh Feedback	M.EFX	Ambie	2409	Neo Seq2 Em-1	M.EFX	EFX	2489	Ripper	S.EFX	SE
2250	Analog Bass5	Bass	SynBs	2330	Fairwave	M.EFX	Ambie	2410	Neo Seq2 Em-2	M.EFX	EFX	2490	Glass	S.EFX	SE
2251	Analog Bass5 Of	Bass	SynBs	2331	Mind Bell	M.EFX	Ambie	2411	Neo Seq2 Em-3	M.EFX	EFX	2491	Bell FX1	S.EFX	SE
2252	Analog Bass6	Bass	SynBs	2332	Sonar1	M.EFX	Ambie	2412	Neo Seq2 Em-4	M.EFX	EFX	2492	Bell FX2	S.EFX	SE
2253	Analog Bass6 Of	Bass	SynBs	2333	Sonar2	M.EFX	Ambie	2413	Neo Seq2 Em-5	M.EFX	EFX	2493	Indus Tom	S.EFX	SE
2254	UniBass	Bass	SynBs	2334	Digi Breath	M.EFX	Ambie	2414	Neo Seq2 Em-6	M.EFX	EFX	2494	Noise Burst	S.EFX	SE
2255	UniBass Of	Bass	SynBs	2335	Engine Room St	M.EFX	Ambie	2415	Neo Seq2 Em-7	M.EFX	EFX	2495	Zap1	S.EFX	SE
2256	T8 Kick Bass	Bass	SynBs	2336	Engine Room L	M.EFX	Ambie	2416	Neo Seq2 Em-8	M.EFX	EFX	2496	Zap2	S.EFX	SE
2257	T8 Kick Bass Of	Bass	SynBs	2337	Engine Room R	M.EFX	Ambie	2417	Portamento Lead Seq	M.EFX	EFX	2497	Electric Perc1	S.EFX	SE
2258	FM Bass1	Bass	SynBs	2338	Moving Chime St	M.EFX	Ambie	2418	Aero Seq All	M.EFX	EFX	2498	Electric Perc2	S.EFX	SE
2259	FM Bass2	Bass	SynBs	2339	Moving Chime L	M.EFX	Ambie	2419	Aero Seq-1	M.EFX	EFX	2499	Electric Perc3	S.EFX	SE
2260	FM Bass3	Bass	SynBs	2340	Moving Chime R	M.EFX	Ambie	2420	Aero Seq-2	M.EFX	EFX	2500	Electric Perc4	S.EFX	SE
2261	FM Bass4	Bass	SynBs	2341	Molton Beam	M.EFX	Ambie	2421	Aero Seq-3	M.EFX	EFX	2501	Electric Perc5	S.EFX	SE
2262	FM Bass5	Bass	SynBs	2342	Bell Spectrum St	M.EFX	Ambie	2422	Aero Seq-4	M.EFX	EFX	2502	Electric Perc6	S.EFX	SE
2263	FM Bass6	Bass	SynBs	2343	Bell Spectrum L	M.EFX	Ambie	2423	Aero Seq-5	M.EFX	EFX	2503	Electric Perc7	S.EFX	SE
2264	Lately-S	Bass	SynBs	2344	Bell Spectrum R	M.EFX	Ambie	2424	Aero Seq-6	M.EFX	EFX	2504	Electric Perc8	S.EFX	SE
2265	Lately-L	Bass	SynBs	2345	Hybrid Pad St	M.EFX	Ambie	2425	Aero Seq-7	M.EFX	EFX	2505	Electric Perc9	S.EFX	SE
2266	Seq Bass	Bass	SynBs	2346	Hybrid Pad L	M.EFX	Ambie	2426	Aero Seq-8	M.EFX	EFX	2506	Electric Perc10	S.EFX	SE
2267	JP Short Seq St	Bass	SynBs	2347	Hybrid Pad R	M.EFX	Ambie	2427	Aero Seq-9	M.EFX	EFX	2507	Electric Perc11	S.EFX	SE
2268	JP Short Seq L	Bass	SynBs	2348	Wavedance St	M.EFX	Ambie	2428	Aero Seq-10	M.EFX	EFX	2508	Electric Perc12	S.EFX	SE
2269	JP Short Seq R	Bass	SynBs	2349	Wavedance L	M.EFX	Ambie	2429	Aero Seq-11	M.EFX	EFX	2509	Electric Perc13	S.EFX	SE
2270	Sharp Perc St	Bass	SynBs	2350	Wavedance R	M.EFX	Ambie	2430	Aero Seq-12	M.EFX	EFX	2510	Electric Perc14	S.EFX	SE
2271	Sharp Perc L	Bass	SynBs	2351	Leftpitch St	M.EFX	Ambie	2431	Aero Seq-13	M.EFX	EFX	2511	Electric Perc15	S.EFX	SE
2272	Sharp Perc R	Bass	SynBs	2352	Leftpitch L	M.EFX	Ambie	2432	Aero Seq-14	M.EFX	EFX	2512	Hi Q1	S.EFX	SE
2273	Short Stepper St	Bass	SynBs	2353	Leftpitch R	M.EFX	Ambie	2433	Aero Seq-15	M.EFX	EFX	2513	Hi Q2	S.EFX	SE
2274	Short Stepper L	Bass	SynBs	2354	Pitchomat St	M.EFX	Ambie	2434	Aero Seq-16	M.EFX	EFX	2514	Vox Hit Rev	S.EFX	SE
2275	Short Stepper R	Bass	SynBs	2355	Pitchomat L	M.EFX	Ambie	2435	Epic Fx Loop1	M.EFX	EFX	2515	Mega Complextro1	S.EFX	SE
2276	Mini Brip1	SynLd	Other	2356	Pitchomat R	M.EFX	Ambie	2436	Epic Fx Loop2	M.EFX	EFX	2516	Mega Complextro2	S.EFX	SE
2277	Mini Brip2	SynLd	Other	2357	Reflecting St	M.EFX	Ambie	2437	Epic Fx Loop3	M.EFX	EFX	2517	Mega Complextro3	S.EFX	SE
2278	Mini Brip3	SynLd	Other	2358	Reflecting L	M.EFX	Ambie	2438	Epic Fx Loop4	M.EFX	EFX	2518	Mega Complextro4	S.EFX	SE
2279	Mini Brip4	SynLd	Other	2359	Reflecting R	M.EFX	Ambie	2439	Epic Fx Loop5	M.EFX	EFX	2519	Mega Complextro5	S.EFX	SE
2280	Mini Brip5	SynLd	Other	2360	Spectrals St	M.EFX	Ambie	2440	Epic Fx Loop6	M.EFX	EFX	2520	Mega Complextro6	S.EFX	SE
2281	Mini Brip6	SynLd	Other	2361	Spectrals L	M.EFX	Ambie	2441	Epic Fx Loop7	M.EFX	EFX	2521	Mega Complextro7	S.EFX	SE
2282	Noise	SynLd	Other	2362	Spectrals R	M.EFX	Ambie	2442	Epic Fx Loop8	M.EFX	EFX	2522	Mega Complextro8	S.EFX	SE
2283	Saturation	SynLd	Other	2363	The Fog St	M.EFX	Ambie	2443	Electer	M.EFX	Other	2523	Granular Loop1	S.EFX	SE
2284	Voc Beat The Band	SyCmp	Voice	2364	The Fog L	M.EFX	Ambie	2444	Multi Piano	M.EFX	Other	2524	Granular Loop2	S.EFX	SE
2285	Voc Born Happy	SyCmp	Voice	2365	The Fog R	M.EFX	Ambie	2445	Radio Noise	M.EFX	Other	2525	Granular Loop3	S.EFX	SE
2286	Voc Close Eyes	SyCmp	Voice	2366	Orchestra Hit1 St	M.EFX	Hit	2446	LFO Seq	M.EFX	Other	2526	Granular Loop4	S.EFX	SE
2287	Voc Complication	SyCmp	Voice	2367	Orchestra Hit1 L	M.EFX	Hit	2447	Raspberry	M.EFX	Other	2527	Granular Loop5	S.EFX	SE
2288	Voc Day Life	SyCmp	Voice	2368	Orchestra Hit1 R	M.EFX	Hit	2448	Digi Heli	M.EFX	Other	2528	Granular Loop6	S.EFX	SE
2289	Voc DeepWater	SyCmp	Voice	2369	Orchestra Hit2 St	M.EFX	Hit	2449	Computer St	M.EFX	Other	2529	Granular Loop7	S.EFX	SE
2290	Voc Desperation	SyCmp	Voice	2370	Orchestra Hit2 L	M.EFX	Hit	2450	Computer L	M.EFX	Other	2530	Granular Loop8	S.EFX	SE
2291	Voc Destiny	SyCmp	Voice	2371	Orchestra Hit2 R	M.EFX	Hit	2451	Computer R	M.EFX	Other	2531	Abstract Fx1	S.EFX	SE
2292	Voc Dreamin Of U	SyCmp	Voice	2372	Orchestra Hit3	M.EFX	Hit	2452	Chatter	M.EFX	Other	2532	Abstract Fx2	S.EFX	SE
2293	Voc Enjoying This	SyCmp	Voice	2373	SlabOrgan1	M.EFX	Hit	2453	Fx Cymbals St	M.EFX	Other	2533	Abstract Fx3	S.EFX	SE
2294	Voc Feel Good	SyCmp	Voice	2374	HH Hit	M.EFX	Hit	2454	Fx Cymbals L	M.EFX	Other	2534	Abstract Fx4	S.EFX	SE
2295	Voc Forbidden Dreams	SyCmp	Voice	2375	Hit Orchestra1	M.EFX	Hit	2455	Fx Cymbals R	M.EFX	Other	2535	Abstract Fx5	S.EFX	SE
2296	Voc Freezing Cold	SyCmp	Voice	2376	Hit Brass	M.EFX	Hit	2456	Warning Mod	M.EFX	Other	2536	Bazer Fx	S.EFX	SE
2297	Voc Infinity	SyCmp	Voice	2377	Slab Orchestra	M.EFX	Hit	2457	Vocal Res	M.EFX	Other	2537	Damage Fx1	S.EFX	SE
2298	Voc Love Is Blind	SyCmp	Voice	2378	Slab Giant	M.EFX	Hit	2458	Hoo	M.EFX	Other	2538	Damage Fx2	S.EFX	SE
2299	Voc Mystery	SyCmp	Voice	2379	Slab Hard	M.EFX	Hit	2459	Bell Choir	M.EFX	Other	2539	Damage Fx3	S.EFX	SE
2300	Voc Reality	SyCmp	Voice	2380	Slab Organ2	M.EFX	Hit	2460	Bell Choir Lp	M.EFX	Other	2540	Damage Fx4	S.EFX	SE
2301	Voc Revolution	SyCmp	Voice	2381	Slab Aah	M.EFX	Hit	2461	VibeNP	M.EFX	Other	2541	Damage Fx5	S.EFX	SE
2302	Voc Sweeping	SyCmp	Voice	2382	Hit Uhh	M.EFX	Hit	2462	Shower St	S.EFX	SE	2542	Damage Fx6	S.EFX	SE
2303	Voc Yesterday	SyCmp	Voice	2383	Hit Orchestra2	M.EFX	Hit	2463	Shower L	S.EFX	SE	2543	Damage Fx7	S.EFX	SE
2304	Birch St	M.EFX	Ambie	2384	Vox Drum	M.EFX	Hit	2464	Shower R	S.EFX	SE	2544	Damage Fx8	S.EFX	SE
2305	Birch L	M.EFX	Ambie	2385	FX Chime	M.EFX	EFX	2465	Fx Female Voice St	S.EFX	SE	2545	Damage Fx9	S.EFX	SE
2306	Birch R	M.EFX	Ambie	2386	Bubble	M.EFX	EFX	2466	Fx Female Voice L	S.EFX	SE	2546	Damage Fx10	S.EFX	SE
2307	Willow St	M.EFX	Ambie	2387	Lektronica	M.EFX	EFX	2467	Fx Female Voice R	S.EFX	SE	2547	Damage Fx11	S.EFX	SE
2308	Willow L	M.EFX	Ambie	2388	Loop145	M.EFX	EFX	2468	Grain1	S.EFX	SE	2548	Dist Synth Fx	S.EFX	SE
2309	Willow R	M.EFX	Ambie	2389	X-Fade	M.EFX	EFX	2469	Grain2 St	S.EFX	SE	2549	HiQ Rize	S.EFX	SE
2310	Anemone St	M.EFX	Ambie	2390	Resonance X-Fade	M.EFX	EFX	2470	Grain2 L	S.EFX	SE	2550	Noize Fx1	S.EFX	SE
2311	Anemone L	M.EFX	Ambie	2391	Quiak	M.EFX	EFX	2471	Grain2 R	S.EFX	SE	2551	Noize Fx2	S.EFX	SE
2312	Anemone R	M.EFX	Ambie	2392	Hop FX1	M.EFX	EFX	2472	Grain3 St	S.EFX	SE	2552	Noize Rize1	S.EFX	SE
2313	Magnitude St	M.EFX	Ambie	2393	Hop FX2	M.EFX	EFX	2473	Grain3 L	S.EFX	SE	2553	Noize Rize2	S.EFX	SE
2314	Magnitude L	M.EFX	Ambie	2394	Neo Seq Em All	M.EFX	EFX	2474	Grain3 R	S.EFX	SE	2554	Shimmer Fx	S.EFX	SE
2315	Magnitude R	M.EFX	Ambie	2395	Neo Seq Em-1	M.EFX	EFX	2475	Moving Harp St	S.EFX	SE	2555	XMod Loop	S.EFX	SE
2316	SabreTone	M.EFX	Ambie	2396	Neo Seq Em-2	M.EFX	EFX	2476	Moving Harp L	S.EFX	SE	2556	Electric Fx Perc1	S.EFX	SE
2317	Vox Bell	M.EFX	Ambie	2397	Neo Seq Em-3	M.EFX	EFX	2477	Moving Harp R	S.EFX	SE	2557	Electric Fx Perc2	S.EFX	SE
2318	Mellow	M.EFX	Ambie	2398	Neo Seq Em-4	M.EFX	EFX	2478	Metal Mod	S.EFX	SE	2558	Electric Fx Perc3	S.EFX	SE
2319	BellAir	M.EFX	Ambie	2399	Neo Seq Em-5	M.EFX	EFX	2479	Digital Wind	S.EFX	SE	2559	Electric Fx Perc4	S.EFX	SE
2320	BigSyn	M.EFX	Ambie	2400	Neo Seq Em-6	M.EFX	EFX	2480	Digi Voice Mod	S.EFX	SE	2560	Electric Fx Perc5	S.EFX	SE

No.	Name	Main Category	Sub Category	No.	Name	Main Category	Sub Category	No.	Name	Main Category	Sub Category	No.	Name	Main Category	Sub Category
2561	Electric Fx Perc6	S.EFX	SE	2641	Scratch Vo R	S.EFX	Sortc	2721	AcousticGtr FX23 L	S.EFX	MgFX	2801	Electric Bass FX 09	S.EFX	MgFX
2562	Electric Fx Perc7	S.EFX	SE	2642	Scratch Stop	S.EFX	Sortc	2722	AcousticGtr FX23 R	S.EFX	MgFX	2802	Electric Bass FX 10	S.EFX	MgFX
2563	Electric Fx Perc8	S.EFX	SE	2643	Scratch Spin	S.EFX	Sortc	2723	AcousticGtr FX24 St	S.EFX	MgFX	2803	Electric Bass FX 11	S.EFX	MgFX
2564	Electric Fx Perc9	S.EFX	SE	2644	Scratch Hip	S.EFX	Sortc	2724	AcousticGtr FX24 L	S.EFX	MgFX	2804	Electric Bass FX 12	S.EFX	MgFX
2565	Electric Fx Perc10	S.EFX	SE	2645	Scratch Hip2	S.EFX	Sortc	2725	AcousticGtr FX24 R	S.EFX	MgFX	2805	Electric Bass FX 13	S.EFX	MgFX
2566	Electric Fx Perc11	S.EFX	SE	2646	Scratch Attack	S.EFX	Sortc	2726	AcousticGtr FX25 St	S.EFX	MgFX	2806	Electric Bass FX 14	S.EFX	MgFX
2567	Electric Fx Perc12	S.EFX	SE	2647	Scratch R&B	S.EFX	Sortc	2727	AcousticGtr FX25 L	S.EFX	MgFX	2807	Electric Bass FX 15	S.EFX	MgFX
2568	Electric Fx Perc13	S.EFX	SE	2648	Scratch Combi	S.EFX	Sortc	2728	AcousticGtr FX25 R	S.EFX	MgFX	2808	Electric Bass FX 16	S.EFX	MgFX
2569	Electric Fx Perc14	S.EFX	SE	2649	Scratch Combi2	S.EFX	Sortc	2729	AcousticGtr FX26 St	S.EFX	MgFX	2809	Electric Bass FX 17	S.EFX	MgFX
2570	Electric Fx Perc15	S.EFX	SE	2650	Scratch Combi3	S.EFX	Sortc	2730	AcousticGtr FX26 L	S.EFX	MgFX	2810	Electric Bass FX 18	S.EFX	MgFX
2571	Electric Fx Perc16	S.EFX	SE	2651	Scratch Combi4	S.EFX	Sortc	2731	AcousticGtr FX26 R	S.EFX	MgFX	2811	Electric Bass FX 19	S.EFX	MgFX
2572	White Noise	S.EFX	SE	2652	HipHop Scratch1 St	S.EFX	Sortc	2732	AcousticGtr FX27 St	S.EFX	MgFX	2812	Electric Bass FX 20	S.EFX	MgFX
2573	Pink Noise	S.EFX	SE	2653	HipHop Scratch2 St	S.EFX	Sortc	2733	AcousticGtr FX27 L	S.EFX	MgFX	2813	Electric Bass FX 21	S.EFX	MgFX
2574	Dub Fx1 Mn	S.EFX	SE	2654	AcousticGtr FX01 St	S.EFX	MgFX	2734	AcousticGtr FX27 R	S.EFX	MgFX	2814	Electric Bass FX 22	S.EFX	MgFX
2575	Dub Fx2 St	S.EFX	SE	2655	AcousticGtr FX01 L	S.EFX	MgFX	2735	AcousticGtr FX28 St	S.EFX	MgFX	2815	Electric Bass FX 23	S.EFX	MgFX
2576	Trap Fx1 St	S.EFX	SE	2656	AcousticGtr FX01 R	S.EFX	MgFX	2736	AcousticGtr FX28 L	S.EFX	MgFX	2816	ShakerA 1/3	Dr/Pc	PC
2577	Trap Fx2 St	S.EFX	SE	2657	AcousticGtr FX02 St	S.EFX	MgFX	2737	AcousticGtr FX28 R	S.EFX	MgFX	2817	ShakerA 1	Dr/Pc	PC
2578	Trap Fx3 St	S.EFX	SE	2658	AcousticGtr FX02 L	S.EFX	MgFX	2738	AcousticGtr FX29 St	S.EFX	MgFX	2818	ShakerA 2	Dr/Pc	PC
2579	Trap Fx4 St	S.EFX	SE	2659	AcousticGtr FX02 R	S.EFX	MgFX	2739	AcousticGtr FX29 L	S.EFX	MgFX	2819	ShakerA 3	Dr/Pc	PC
2580	Trap Fx5 St	S.EFX	SE	2660	AcousticGtr FX03 St	S.EFX	MgFX	2740	AcousticGtr FX29 R	S.EFX	MgFX	2820	ShakerB Sw	Dr/Pc	PC
2581	Trap Fx6 St	S.EFX	SE	2661	AcousticGtr FX03 L	S.EFX	MgFX	2741	AcousticGtr FX30 St	S.EFX	MgFX	2821	ShakerB Shake	Dr/Pc	PC
2582	HipHop Fx1 St	S.EFX	SE	2662	AcousticGtr FX03 R	S.EFX	MgFX	2742	AcousticGtr FX30 L	S.EFX	MgFX	2822	ShakerB Hit	Dr/Pc	PC
2583	HipHop Fx2 St	S.EFX	SE	2663	AcousticGtr FX04 St	S.EFX	MgFX	2743	AcousticGtr FX30 R	S.EFX	MgFX	2823	ShakerC 1 Sw	Dr/Pc	PC
2584	HipHop Fx3 St	S.EFX	SE	2664	AcousticGtr FX04 L	S.EFX	MgFX	2744	AcousticGtr FX31 St	S.EFX	MgFX	2824	ShakerC 2 Sw	Dr/Pc	PC
2585	EDM Fx1 St	S.EFX	SE	2665	AcousticGtr FX04 R	S.EFX	MgFX	2745	AcousticGtr FX32 St	S.EFX	MgFX	2825	Shaker Hip1	Dr/Pc	PC
2586	EDM Fx2 St	S.EFX	SE	2666	AcousticGtr FX05 St	S.EFX	MgFX	2746	AcousticGtr FX33 St	S.EFX	MgFX	2826	Shaker Hip2	Dr/Pc	PC
2587	EDM Fx3 St	S.EFX	SE	2667	AcousticGtr FX05 L	S.EFX	MgFX	2747	AcousticGtr FX34 St	S.EFX	MgFX	2827	Shaker Hip3	Dr/Pc	PC
2588	House Fx1 Mn	S.EFX	SE	2668	AcousticGtr FX05 R	S.EFX	MgFX	2748	AcousticGtr FX35 St	S.EFX	MgFX	2828	Shaker Hip4	Dr/Pc	PC
2589	House Fx2 St	S.EFX	SE	2669	AcousticGtr FX06 St	S.EFX	MgFX	2749	Flamenco SlideNoise1	S.EFX	MgFX	2829	Std Shaker	Dr/Pc	PC
2590	House Fx3 St	S.EFX	SE	2670	AcousticGtr FX06 L	S.EFX	MgFX	2750	Flamenco SlideNoise2	S.EFX	MgFX	2830	Shaker Fresh 1	Dr/Pc	PC
2591	House Fx Sw	Dr/Pc	PC	2671	AcousticGtr FX06 R	S.EFX	MgFX	2751	Flamenco SlideNoise3	S.EFX	MgFX	2831	Shaker Fresh 2	Dr/Pc	PC
2592	Electro Fx St	S.EFX	SE	2672	AcousticGtr FX07 St	S.EFX	MgFX	2752	Flamenco TapClick	S.EFX	MgFX	2832	Shaker Fresh 3	Dr/Pc	PC
2593	Vocal Snare St	S.EFX	SE	2673	AcousticGtr FX07 L	S.EFX	MgFX	2753	ElectricGtr FX01	S.EFX	MgFX	2833	Shaker Muffled 1 St	Dr/Pc	PC
2594	Vocal Ambi SE St	S.EFX	SE	2674	AcousticGtr FX07 R	S.EFX	MgFX	2754	ElectricGtr FX02	S.EFX	MgFX	2834	Shaker Muffled 2 St	Dr/Pc	PC
2595	Vocal Shout Yeah St	S.EFX	SE	2675	AcousticGtr FX08 St	S.EFX	MgFX	2755	ElectricGtr FX03	S.EFX	MgFX	2835	HipHop Shaker1 Mn	Dr/Pc	PC
2596	Vocal Shout Go St	S.EFX	SE	2676	AcousticGtr FX08 L	S.EFX	MgFX	2756	ElectricGtr FX04	S.EFX	MgFX	2836	HipHop Shaker2 Mn	Dr/Pc	PC
2597	Rainmaker St	S.EFX	SE	2677	AcousticGtr FX08 R	S.EFX	MgFX	2757	ElectricGtr FX05	S.EFX	MgFX	2837	HipHop Shaker Sw	Dr/Pc	PC
2598	Glitch 1	S.EFX	SE	2678	AcousticGtr FX09 St	S.EFX	MgFX	2758	ElectricGtr FX06	S.EFX	MgFX	2838	HipHop Shaker Lng Mn	Dr/Pc	PC
2599	Glitch 2	S.EFX	SE	2679	AcousticGtr FX09 L	S.EFX	MgFX	2759	ElectricGtr FX07	S.EFX	MgFX	2839	House Shaker1 Mn	Dr/Pc	PC
2600	Glitch 3	S.EFX	SE	2680	AcousticGtr FX09 R	S.EFX	MgFX	2760	ElectricGtr FX08	S.EFX	MgFX	2840	House Shaker2 Mn	Dr/Pc	PC
2601	Glitch 4	S.EFX	SE	2681	AcousticGtr FX10 St	S.EFX	MgFX	2761	ElectricGtr FX09	S.EFX	MgFX	2841	House Shaker St	Dr/Pc	PC
2602	Glitch 5	S.EFX	SE	2682	AcousticGtr FX10 L	S.EFX	MgFX	2762	ElectricGtr FX10	S.EFX	MgFX	2842	House Shaker Long Mn	Dr/Pc	PC
2603	Glitch 6	S.EFX	SE	2683	AcousticGtr FX10 R	S.EFX	MgFX	2763	ElectricGtr FX11	S.EFX	MgFX	2843	Tambourine1 Sw	Dr/Pc	PC
2604	Glitch 7	S.EFX	SE	2684	AcousticGtr FX11 St	S.EFX	MgFX	2764	ElectricGtr FX12	S.EFX	MgFX	2844	Tambourine1 Shake	Dr/Pc	PC
2605	Glitch 8	S.EFX	SE	2685	AcousticGtr FX11 L	S.EFX	MgFX	2765	ElectricGtr FX13	S.EFX	MgFX	2845	Tambourine1 Hit	Dr/Pc	PC
2606	Glitch 9	S.EFX	SE	2686	AcousticGtr FX11 R	S.EFX	MgFX	2766	ElectricGtr FX14	S.EFX	MgFX	2846	Tambourine2 Sw	Dr/Pc	PC
2607	Glitch 10	S.EFX	SE	2687	AcousticGtr FX12 St	S.EFX	MgFX	2767	ElectricGtr FX15	S.EFX	MgFX	2847	Tambourine2 Shake	Dr/Pc	PC
2608	T8 Bend	S.EFX	SE	2688	AcousticGtr FX12 L	S.EFX	MgFX	2768	ElectricGtr FX16	S.EFX	MgFX	2848	Tambourine2 Hit	Dr/Pc	PC
2609	T8 Bass SE St	S.EFX	SE	2689	AcousticGtr FX12 R	S.EFX	MgFX	2769	ElectricGtr FX17	S.EFX	MgFX	2849	Tambourine3	Dr/Pc	PC
2610	Bomb	S.EFX	SE	2690	AcousticGtr FX13 St	S.EFX	MgFX	2770	ElectricGtr FX18	S.EFX	MgFX	2850	Tambourine FX 1	Dr/Pc	PC
2611	Tape Rewind	S.EFX	SE	2691	AcousticGtr FX13 L	S.EFX	MgFX	2771	ElectricGtr FX19	S.EFX	MgFX	2851	Tambourine FX 2	Dr/Pc	PC
2612	FxGun1	S.EFX	SE	2692	AcousticGtr FX13 R	S.EFX	MgFX	2772	ElectricGtr FX20	S.EFX	MgFX	2852	HipHop Tamb 1 Mn	Dr/Pc	PC
2613	FxGun2	S.EFX	SE	2693	AcousticGtr FX14 St	S.EFX	MgFX	2773	ElectricGtr FX21	S.EFX	MgFX	2853	HipHop Tamb 2 Mn	Dr/Pc	PC
2614	Thunder	S.EFX	SE	2694	AcousticGtr FX14 L	S.EFX	MgFX	2774	ElectricGtr FX22	S.EFX	MgFX	2854	HipHop Tamb 3 Sw	Dr/Pc	PC
2615	Swarm	S.EFX	SE	2695	AcousticGtr FX14 R	S.EFX	MgFX	2775	ElectricGtr FX23	S.EFX	MgFX	2855	Stick1	Dr/Pc	PC
2616	TurnTable	S.EFX	SE	2696	AcousticGtr FX15 St	S.EFX	MgFX	2776	TC FX01	S.EFX	MgFX	2856	Stick2	Dr/Pc	PC
2617	Police	S.EFX	SE	2697	AcousticGtr FX15 L	S.EFX	MgFX	2777	TC FX02	S.EFX	MgFX	2857	HipHop Stick1 Mn	Dr/Pc	PC
2618	Door Squeak	S.EFX	SE	2698	AcousticGtr FX15 R	S.EFX	MgFX	2778	TC FX03	S.EFX	MgFX	2858	HipHop Stick2 Mn	Dr/Pc	PC
2619	Heart Beat	S.EFX	SE	2699	AcousticGtr FX16 St	S.EFX	MgFX	2779	TC FX04	S.EFX	MgFX	2859	HipHop Stick Sw	Dr/Pc	PC
2620	Helicopter	S.EFX	SE	2700	AcousticGtr FX16 L	S.EFX	MgFX	2780	TC FX05	S.EFX	MgFX	2860	Castanet1	Dr/Pc	PC
2621	Seashore	S.EFX	SE	2701	AcousticGtr FX16 R	S.EFX	MgFX	2781	TC FX06	S.EFX	MgFX	2861	Castanet2 Sw	Dr/Pc	PC
2622	Telephone	S.EFX	SE	2702	AcousticGtr FX17 St	S.EFX	MgFX	2782	TC FX07	S.EFX	MgFX	2862	Castanet2 Soft	Dr/Pc	PC
2623	TelRing	S.EFX	SE	2703	AcousticGtr FX17 L	S.EFX	MgFX	2783	TC FX08	S.EFX	MgFX	2863	Castanet2 Hard	Dr/Pc	PC
2624	Bird	S.EFX	SE	2704	AcousticGtr FX17 R	S.EFX	MgFX	2784	Acoustic Bass FX01	S.EFX	MgFX	2864	Castanet3 Flam1	Dr/Pc	Ethnc
2625	Stream	S.EFX	SE	2705	AcousticGtr FX18 St	S.EFX	MgFX	2785	Acoustic Bass FX02	S.EFX	MgFX	2865	Castanet3 Flam2	Dr/Pc	Ethnc
2626	Gunshot	S.EFX	SE	2706	AcousticGtr FX18 L	S.EFX	MgFX	2786	Acoustic Bass FX03	S.EFX	MgFX	2866	Castanet3 LH Normal	Dr/Pc	Ethnc
2627	Applause	S.EFX	SE	2707	AcousticGtr FX18 R	S.EFX	MgFX	2787	Acoustic Bass FX04	S.EFX	MgFX	2867	Castanet3 LH Mute	Dr/Pc	Ethnc
2628	RainLoop	S.EFX	SE	2708	AcousticGtr FX19 St	S.EFX	MgFX	2788	Acoustic Bass FX05	S.EFX	MgFX	2868	Castanet3 LH&RH Nml	Dr/Pc	Ethnc
2629	Scratch H	S.EFX	Sortc	2709	AcousticGtr FX19 L	S.EFX	MgFX	2789	Acoustic Bass FX06	S.EFX	MgFX	2869	Castanet3 LH&RH Mute	Dr/Pc	Ethnc
2630	Scratch L	S.EFX	Sortc	2710	AcousticGtr FX19 R	S.EFX	MgFX	2790	Acoustic Bass FX07	S.EFX	MgFX	2870	Castanet3 RH Normal	Dr/Pc	Ethnc
2631	Scratch Down	S.EFX	Sortc	2711	AcousticGtr FX20 St	S.EFX	MgFX	2791	Acoustic Bass FX08	S.EFX	MgFX	2871	Castanet3 RH Mute	Dr/Pc	Ethnc
2632	Scratch Hi F	S.EFX	Sortc	2712	AcousticGtr FX20 L	S.EFX	MgFX	2792	Acoustic Bass FX09	S.EFX	MgFX	2872	Wood Block	Dr/Pc	PC
2633	Scratch Hi R	S.EFX	Sortc	2713	AcousticGtr FX20 R	S.EFX	MgFX	2793	Electric Bass FX 01	S.EFX	MgFX	2873	HipHop WB1 Mn	Dr/Pc	PC
2634	Scratch Lo F	S.EFX	Sortc	2714	AcousticGtr FX21 St	S.EFX	MgFX	2794	Electric Bass FX 02	S.EFX	MgFX	2874	HipHop WB2 Mn	Dr/Pc	PC
2635	Scratch Lo R	S.EFX	Sortc	2715	AcousticGtr FX21 L	S.EFX	MgFX	2795	Electric Bass FX 03	S.EFX	MgFX	2875	HipHop WB3 Mn	Dr/Pc	PC
2636	Scratch Bd F	S.EFX	Sortc	2716	AcousticGtr FX21 R	S.EFX	MgFX	2796	Electric Bass FX 04	S.EFX	MgFX	2876	House WB1 Mn	Dr/Pc	PC
2637	Scratch Bd R	S.EFX	Sortc	2717	AcousticGtr FX22 St	S.EFX	MgFX	2797	Electric Bass FX 05	S.EFX	MgFX	2877	House WB2 Mn	Dr/Pc	PC
2638	Scratch Sd F	S.EFX	Sortc	2718	AcousticGtr FX22 L	S.EFX	MgFX	2798	Electric Bass FX 06	S.EFX	MgFX	2878	House WB3 Mn	Dr/Pc	PC
2639	Scratch Sd R	S.EFX	Sortc	2719	AcousticGtr FX22 R	S.EFX	MgFX	2799	Electric Bass FX 07	S.EFX	MgFX	2879	Vibraslap1	Dr/Pc	PC
2640	Scratch Vo F	S.EFX	Sortc	2720	AcousticGtr FX23 St	S.EFX	MgFX	2800	Electric Bass FX 08	S.EFX	MgFX	2880	Vibraslap2	Dr/Pc	PC

No.	Name	Main Category	Sub Category	No.	Name	Main Category	Sub Category	No.	Name	Main Category	Sub Category	No.	Name	Main Category	Sub Category
2881	Vibraslap3	Dr/Pc	PC	2961	Khalg Conga1 Lo Dom1	Dr/Pc	Ethnc	3041	Timbale2 Lo 1	Dr/Pc	PC	3121	MetalGuero Long	Dr/Pc	PC
2882	Triangle1 Sw	Dr/Pc	PC	2962	Khalg Conga1 Lo Dom2	Dr/Pc	Ethnc	3042	Timbale2 Lo 2	Dr/Pc	PC	3122	Reco1	Dr/Pc	PC
2883	Triangle1 Open	Dr/Pc	PC	2963	Khalg Conga1 Lo Sak1	Dr/Pc	Ethnc	3043	Timbale2 Lo Rim	Dr/Pc	PC	3123	Reco2	Dr/Pc	PC
2884	Triangle1 Mute	Dr/Pc	PC	2964	Khalg Conga2 Hi Dom	Dr/Pc	Ethnc	3044	Timbale3 Lo	Dr/Pc	PC	3124	Surdo1 Open	Dr/Pc	PC
2885	Triangle2 Open	Dr/Pc	PC	2965	Khalg Conga2 Hi Sak	Dr/Pc	Ethnc	3045	Timbale3 Hi	Dr/Pc	PC	3125	Surdo1 Mute	Dr/Pc	PC
2886	Triangle2 Mute	Dr/Pc	PC	2966	Quinto1 Open	Dr/Pc	PC	3046	Timbale3 Lo Rim	Dr/Pc	PC	3126	Surdo2 Open	Dr/Pc	PC
2887	Triangle3 Open	Dr/Pc	PC	2967	Quinto1 Slap	Dr/Pc	PC	3047	Timbale3 Hi Rim	Dr/Pc	PC	3127	Surdo2 Mute	Dr/Pc	PC
2888	Triangle3 Mute	Dr/Pc	PC	2968	Quinto2 Open	Dr/Pc	PC	3048	Timbale4 Lo	Dr/Pc	PC	3128	Surdo3 Stop	Dr/Pc	PC
2889	Hand Clap1 St	Dr/Pc	PC	2969	Quinto2 Heel	Dr/Pc	PC	3049	Tanak Dom1	Dr/Pc	Ethnc	3129	Surdo3 Open	Dr/Pc	PC
2890	Hand Clap1 L	Dr/Pc	PC	2970	Tumba Open	Dr/Pc	PC	3050	Tanak Dom2	Dr/Pc	Ethnc	3130	Surdo3 Mute	Dr/Pc	PC
2891	Hand Clap1 R	Dr/Pc	PC	2971	Tumba Slap	Dr/Pc	PC	3051	Paila L	Dr/Pc	PC	3131	Surdo4 Stop	Dr/Pc	PC
2892	Hand Clap2 Sw	Dr/Pc	PC	2972	Tumba Tip	Dr/Pc	PC	3052	Paila H	Dr/Pc	PC	3132	Surdo4 Open	Dr/Pc	PC
2893	Hand Clap2 Close	Dr/Pc	PC	2973	Tumba Heel	Dr/Pc	PC	3053	Ganza1 Accent	Dr/Pc	PC	3133	Surdo4 Mute	Dr/Pc	PC
2894	Hand Clap2 Open	Dr/Pc	PC	2974	Cuica1 Lo	Dr/Pc	PC	3054	Ganza1 Back	Dr/Pc	PC	3134	Surdo5-1 Stop	Dr/Pc	PC
2895	Hand Clap3 Sw	Dr/Pc	PC	2975	Cuica1 Hi	Dr/Pc	PC	3055	Ganza1 Forward	Dr/Pc	PC	3135	Surdo5-1 Open	Dr/Pc	PC
2896	Hand Clap4	Dr/Pc	PC	2976	Cuica2 Low	Dr/Pc	PC	3056	Ganza2 Forward1	Dr/Pc	PC	3136	Surdo5-1 Mute	Dr/Pc	PC
2897	Arabic Hand Clap	Dr/Pc	Ethnc	2977	Cuica2 Med	Dr/Pc	PC	3057	Ganza2 Forward2	Dr/Pc	PC	3137	Surdo5-2 Sdstck	Dr/Pc	PC
2898	Khaligi Hand Clap1	Dr/Pc	Ethnc	2978	Cuica2 Hi	Dr/Pc	PC	3058	Maracas1 Sw	Dr/Pc	PC	3138	Tntan1 Body	Dr/Pc	PC
2899	Khaligi Hand Clap2	Dr/Pc	Ethnc	2979	Bongo1 Hi 1Finger 1-2	Dr/Pc	PC	3059	Maracas1 Slur	Dr/Pc	PC	3139	Tntan1 Slap RH	Dr/Pc	PC
2900	Khaligi Hand Clap3	Dr/Pc	Ethnc	2980	Bongo1 Hi 1Finger 1	Dr/Pc	PC	3060	Maracas1 Staccato	Dr/Pc	PC	3140	Tntan1 Thmb Open RH	Dr/Pc	PC
2901	Khaligi Hand Clap4	Dr/Pc	Ethnc	2981	Bongo1 Hi 1Finger 2	Dr/Pc	PC	3061	Maracas2	Dr/Pc	PC	3141	Tntan2 Open RH	Dr/Pc	PC
2902	Iran Hand Clap	Dr/Pc	Ethnc	2982	Bongo1 Hi 3Finger 1-2	Dr/Pc	PC	3062	Cabasa1A 1-2	Dr/Pc	PC	3142	Tntan2 Body LH	Dr/Pc	PC
2903	Finger Snap1	Dr/Pc	PC	2983	Bongo1 Hi 3Finger 1	Dr/Pc	PC	3063	Cabasa1A 1	Dr/Pc	PC	3143	Tntan2 Slap RH	Dr/Pc	PC
2904	Finger Snap2	Dr/Pc	PC	2984	Bongo1 Hi 3Finger 2	Dr/Pc	PC	3064	Cabasa1A 2	Dr/Pc	PC	3144	Tntan2 Open RH	Dr/Pc	PC
2905	Finger Snap3	Dr/Pc	PC	2985	Bongo1 Hi Rim	Dr/Pc	PC	3065	Cabasa1B 1-4	Dr/Pc	PC	3145	Tntan2 Close RH	Dr/Pc	PC
2906	Handbell L	Dr/Pc	PC	2986	Bongo1 Hi Tip	Dr/Pc	PC	3066	Cabasa1B 1	Dr/Pc	PC	3146	Zabmba StICK LH	Dr/Pc	PC
2907	Handbell H	Dr/Pc	PC	2987	Bongo1 Hi Heel	Dr/Pc	PC	3067	Cabasa1B 2	Dr/Pc	PC	3147	Zabmba Open RH	Dr/Pc	PC
2908	Sleigh Bell1	Dr/Pc	PC	2988	Bongo1 Hi Slap	Dr/Pc	PC	3068	Cabasa1B 3	Dr/Pc	PC	3148	Zabmba Mute RH	Dr/Pc	PC
2909	Sleigh Bell2	Dr/Pc	PC	2989	Bongo1 Lo 1Finger 1-2	Dr/Pc	PC	3069	Cabasa1B 4	Dr/Pc	PC	3149	Cajon1 Kick	Dr/Pc	PC
2910	Ghunguru	Dr/Pc	PC	2990	Bongo1 Lo 1Finger 1	Dr/Pc	PC	3070	Cabasa2	Dr/Pc	PC	3150	Cajon1 Slap	Dr/Pc	PC
2911	Chocal Forward	Dr/Pc	PC	2991	Bongo1 Lo 1Finger 2	Dr/Pc	PC	3071	Cabasa3	Dr/Pc	PC	3151	Cajon1 Tip 1-2	Dr/Pc	PC
2912	Wind Chime 1	Dr/Pc	PC	2992	Bongo1 Lo 3Finger 1-2	Dr/Pc	PC	3072	Cabasa4	Dr/Pc	PC	3152	Cajon1 Tip 1	Dr/Pc	PC
2913	Wind Chime 2 St	Dr/Pc	PC	2993	Bongo1 Lo 3Finger 1	Dr/Pc	PC	3073	Caxixi 1-2	Dr/Pc	PC	3153	Cajon1 Tip 2	Dr/Pc	PC
2914	Resin Block Small	Dr/Pc	PC	2994	Bongo1 Lo 3Finger 2	Dr/Pc	PC	3074	Caxixi 1	Dr/Pc	PC	3154	Cajon2 Foot	Dr/Pc	PC
2915	Resin Block Large	Dr/Pc	PC	2995	Bongo1 Lo Rim	Dr/Pc	PC	3075	Caxixi 2	Dr/Pc	PC	3155	Cajon2 Lo	Dr/Pc	PC
2916	OrchTamb Shake-Hit	Dr/Pc	PC	2996	Bongo1 Lo Tip	Dr/Pc	PC	3076	Caxixi 3	Dr/Pc	PC	3156	Cajon2 Slap	Dr/Pc	PC
2917	OrchTamb Shake 1-2	Dr/Pc	PC	2997	Bongo2 Hi Mute	Dr/Pc	PC	3077	Aloxe Open	Dr/Pc	PC	3157	Cajon2 Mute	Dr/Pc	PC
2918	OrchTamb Shake 1	Dr/Pc	PC	2998	Bongo2 Hi Open 1-2	Dr/Pc	PC	3078	Tumbo 1	Dr/Pc	PC	3158	Cajon2 Tip	Dr/Pc	PC
2919	OrchTamb Shake 2	Dr/Pc	PC	2999	Bongo2 Hi Open 1	Dr/Pc	PC	3079	Tumbo 2	Dr/Pc	PC	3159	Cajon2 Ghost1	Dr/Pc	PC
2920	OrchTamb Hit Close	Dr/Pc	PC	3000	Bongo2 Hi Open 2	Dr/Pc	PC	3080	Tumbo 3	Dr/Pc	PC	3160	Cajon2 Ghost2	Dr/Pc	PC
2921	OrchTamb Hit Open	Dr/Pc	PC	3001	Bongo2 Lo Mute	Dr/Pc	PC	3081	Tumbo4 Up	Dr/Pc	PC	3161	Cajon3 Vari 1	Dr/Pc	Ethnc
2922	Conga1 Hi Tip	Dr/Pc	PC	3002	Bongo2 Lo Open 1-2	Dr/Pc	PC	3082	Tumbo4 Down	Dr/Pc	PC	3162	Cajon3 Vari 2	Dr/Pc	Ethnc
2923	Conga1 Hi Heel	Dr/Pc	PC	3003	Bongo2 Lo Open 1	Dr/Pc	PC	3083	Tumbo5 Finger Back	Dr/Pc	PC	3163	Cajon3 Vari 3	Dr/Pc	Ethnc
2924	Conga1 Hi Open 1-2	Dr/Pc	PC	3004	Bongo2 Lo Open 2	Dr/Pc	PC	3084	Tumbo5 Center Open	Dr/Pc	PC	3164	Cajon3 Vari 4	Dr/Pc	Ethnc
2925	Conga1 Hi Open 1	Dr/Pc	PC	3005	Bongo3 Hi Open	Dr/Pc	PC	3085	Tumbo5 Rim Close	Dr/Pc	PC	3165	Cajon3 Vari 5	Dr/Pc	Ethnc
2926	Conga1 Hi Open 2	Dr/Pc	PC	3006	Bongo3 Lo Open	Dr/Pc	PC	3086	Pandeiro1 Open	Dr/Pc	PC	3166	Cajon3 Vari 6	Dr/Pc	Ethnc
2927	Conga1 Hi Mute	Dr/Pc	PC	3007	Bongo Extent 1 St	Dr/Pc	PC	3087	Pandeiro1 Thump	Dr/Pc	PC	3167	Cajon3 Vari 7	Dr/Pc	Ethnc
2928	Conga1 Hi Slap Open	Dr/Pc	PC	3008	Bongo Extent 2 St	Dr/Pc	PC	3088	Pandeiro1 Tip	Dr/Pc	PC	3168	Cajon3 Vari 8	Dr/Pc	Ethnc
2929	Conga1 Hi Slap	Dr/Pc	PC	3009	Bongo Extent 3 St	Dr/Pc	PC	3089	Pandeiro1 Heel	Dr/Pc	PC	3169	Cajon3 Vari 9	Dr/Pc	Ethnc
2930	Conga1 Hi SlapMute1-2	Dr/Pc	PC	3010	HipHop Bongo1 Mn	Dr/Pc	PC	3090	Pandeiro2 LHeel	Dr/Pc	PC	3170	Cajon3 Vari 10	Dr/Pc	Ethnc
2931	Conga1 Hi SlapMute1	Dr/Pc	PC	3011	HipHop Bongo2 Mn	Dr/Pc	PC	3091	Pandeiro2 LToe Rim	Dr/Pc	PC	3171	Cajon3 Vari 11	Dr/Pc	Ethnc
2932	Conga1 Hi SlapMute2	Dr/Pc	PC	3012	Khalg Bongo Lo Dom	Dr/Pc	Ethnc	3092	Pandeiro2 LSlap	Dr/Pc	PC	3172	Cajon3 Vari 12	Dr/Pc	Ethnc
2933	Conga1 Lo Tip	Dr/Pc	PC	3013	Khalg Bongo Lo Sak	Dr/Pc	Ethnc	3093	Pandeiro2 LThmb Opn	Dr/Pc	PC	3173	Cajon3 Vari 13	Dr/Pc	Ethnc
2934	Conga1 Lo Heel	Dr/Pc	PC	3014	Khalg Bongo Lo Tak	Dr/Pc	Ethnc	3094	Pandeiro2 LThmb Cls	Dr/Pc	PC	3174	Cajon3 Vari 14	Dr/Pc	Ethnc
2935	Conga1 Lo Open 1-2	Dr/Pc	PC	3015	Khalg Bongo Hi Snap1	Dr/Pc	Ethnc	3095	Pandeiro2 LRoll	Dr/Pc	PC	3175	Cajon3 Vari 15	Dr/Pc	Ethnc
2936	Conga1 Lo Open 1	Dr/Pc	PC	3016	Khalg Bongo Hi Snap2	Dr/Pc	Ethnc	3096	Pandeiro2 CHeel	Dr/Pc	PC	3176	Cajon3 Vari 16	Dr/Pc	Ethnc
2937	Conga1 Lo Open 2	Dr/Pc	PC	3017	Khalg Bongo Hi Sak	Dr/Pc	Ethnc	3097	Pandeiro2 CToLo Opn	Dr/Pc	PC	3177	Cajon3 Vari 17	Dr/Pc	Ethnc
2938	Conga1 Lo Mute	Dr/Pc	PC	3018	Iran Bongo Lo Tom	Dr/Pc	Ethnc	3098	Pandeiro2 CSlap	Dr/Pc	PC	3178	Cajon3 Vari 18	Dr/Pc	Ethnc
2939	Conga1 Lo Slap Open	Dr/Pc	PC	3019	Iran Bongo Lo Fim Tm	Dr/Pc	Ethnc	3099	Pandeiro2 CThmb Opn	Dr/Pc	PC	3179	Cajon3 Vari 19	Dr/Pc	Ethnc
2940	Conga2 Hi Heel	Dr/Pc	PC	3020	Iran Bongo Lo Roll	Dr/Pc	Ethnc	3100	Pandeiro2 CThmb Cls	Dr/Pc	PC	3180	Cajon3 Vari 20	Dr/Pc	Ethnc
2941	Conga2 Hi Tip	Dr/Pc	PC	3021	Iran Bongo Hi Bk LH	Dr/Pc	Ethnc	3101	Pandeiro2 CRoll Lng	Dr/Pc	PC	3181	Cajon3 Vari 21	Dr/Pc	Ethnc
2942	Conga2 Hi Slap 1-2	Dr/Pc	PC	3022	Iran Bongo Hi Bk RH	Dr/Pc	Ethnc	3102	Tmbourim Open	Dr/Pc	PC	3182	Cajon3 Vari 22	Dr/Pc	Ethnc
2943	Conga2 Hi Slap 1	Dr/Pc	PC	3023	Iran Bongo Hi Mt RH	Dr/Pc	Ethnc	3103	Tmbourim Finger	Dr/Pc	PC	3183	Cajon3 Vari 23	Dr/Pc	Ethnc
2944	Conga2 Hi Slap 2	Dr/Pc	PC	3024	Iran Bongo Hi Fim Bk	Dr/Pc	Ethnc	3104	Tmbourim Mute	Dr/Pc	PC	3184	Cajon3 Vari 24	Dr/Pc	Ethnc
2945	Conga2 Hi Open 1-2	Dr/Pc	PC	3025	Iran Bongo Hi Roll	Dr/Pc	Ethnc	3105	Agogo1 Hi	Dr/Pc	PC	3185	Cajon3 Vari 25	Dr/Pc	Ethnc
2946	Conga2 Hi Open 1	Dr/Pc	PC	3026	Timbale1 Hi 1-3	Dr/Pc	PC	3106	Agogo1 Lo	Dr/Pc	PC	3186	Cajon3 Vari 26	Dr/Pc	Ethnc
2947	Conga2 Hi Open 2	Dr/Pc	PC	3027	Timbale1 Hi 1	Dr/Pc	PC	3107	Agogo1 Lo1 Tap	Dr/Pc	PC	3187	Cajon3 Vari 27	Dr/Pc	Ethnc
2948	Conga2 Hi Mute	Dr/Pc	PC	3028	Timbale1 Hi 2	Dr/Pc	PC	3108	Agogo2 Bell1	Dr/Pc	PC	3188	Cajon3 Vari 28	Dr/Pc	Ethnc
2949	Conga2 Lo Open 1-2	Dr/Pc	PC	3029	Timbale1 Hi 3	Dr/Pc	PC	3109	Agogo2 Bell2	Dr/Pc	PC	3189	Cajon3 Vari 29	Dr/Pc	Ethnc
2950	Conga2 Lo Open 1	Dr/Pc	PC	3030	Timbale1 Lo 1-2	Dr/Pc	PC	3110	Agogo3 Click	Dr/Pc	PC	3190	Cajon3 Vari 30	Dr/Pc	Ethnc
2951	Conga2 Lo Open 2	Dr/Pc	PC	3031	Timbale1 Lo 1	Dr/Pc	PC	3111	Agogo4 Click	Dr/Pc	PC	3191	Cajon3 Vari 31	Dr/Pc	Ethnc
2952	Conga2 Lo Slide	Dr/Pc	PC	3032	Timbale1 Lo 2	Dr/Pc	PC	3112	Guiro1 Long	Dr/Pc	PC	3192	Cajon3 Vari 32	Dr/Pc	Ethnc
2953	Conga3 Hi Open	Dr/Pc	PC	3033	Timbale1 Rim	Dr/Pc	PC	3113	Guiro1 Short	Dr/Pc	PC	3193	Cajon3 Vari 33	Dr/Pc	Ethnc
2954	Conga3 Hi Mute	Dr/Pc	PC	3034	Timbale1 Paila H	Dr/Pc	PC	3114	Guiro1 Swp	Dr/Pc	PC	3194	Cajon3 Vari 34	Dr/Pc	Ethnc
2955	Conga3 Lo Open	Dr/Pc	PC	3035	Timbale1 Paila L	Dr/Pc	PC	3115	Guiro2 Long	Dr/Pc	PC	3195	Cajon3 Vari 35	Dr/Pc	Ethnc
2956	Conga Fine 1 St	Dr/Pc	PC	3036	Timbale2 Hi Sw	Dr/Pc	PC	3116	HipHop Guiro Mn	Dr/Pc	PC	3196	Cajon3 Vari 36	Dr/Pc	Ethnc
2957	Conga Fine 2 St	Dr/Pc	PC	3037	Timbale2 Hi 1	Dr/Pc	PC	3117	House Guiro Mn	Dr/Pc	PC	3197	Cajon3 Vari 37	Dr/Pc	Ethnc
2958	Conga FX	Dr/Pc	PC	3038	Timbale2 Hi 2	Dr/Pc	PC	3118	MetalGuero Short 1-2	Dr/Pc	PC	3198	Cajon3 Vari 38	Dr/Pc	Ethnc
2959	Khalg Conga1 Hi Sak1	Dr/Pc	Ethnc	3039	Timbale2 Hi Rim	Dr/Pc	PC	3119	MetalGuero Short 1	Dr/Pc	PC	3199	Cajon3 Vari 39	Dr/Pc	Ethnc
2960	Khalg Conga1 Hi Sak2	Dr/Pc	Ethnc	3040	Timbale2 Lo Sw	Dr/Pc	PC	3120	MetalGuero Short 2	Dr/Pc	PC	3200	Cajon3 Vari 40	Dr/Pc	Ethnc

No.	Name	Main Category	Sub Category	No.	Name	Main Category	Sub Category	No.	Name	Main Category	Sub Category	No.	Name	Main Category	Sub Category
3201	Cajon3 Vari 41	Dr/Pc	Ethnc	3281	Djembe3 Mute	Dr/Pc	Ethnc	3361	Kurdish Dohol2LoBuzz	Dr/Pc	Ethnc	3441	Shekere Up	Dr/Pc	Ethnc
3202	Cajon3 Vari 42	Dr/Pc	Ethnc	3282	Djembe4 Dom1	Dr/Pc	Ethnc	3362	Lurish Dohol Lo	Dr/Pc	Ethnc	3442	Shekere Slap	Dr/Pc	Ethnc
3203	Cajon3 Vari 43	Dr/Pc	Ethnc	3283	Djembe4 Dom2	Dr/Pc	Ethnc	3363	Lurish Dohol Lo Buzz	Dr/Pc	Ethnc	3443	TalkingDrum Open	Dr/Pc	Ethnc
3204	Cajon3 Vari 44	Dr/Pc	Ethnc	3284	Djembe4 Tak1	Dr/Pc	Ethnc	3364	Lurish Dohol Hi	Dr/Pc	Ethnc	3444	TalkingDrum Slap	Dr/Pc	Ethnc
3205	Cajon3 Vari 45	Dr/Pc	Ethnc	3285	Djembe4 Tak2	Dr/Pc	Ethnc	3365	Nakrazan Dom	Dr/Pc	Ethnc	3445	TalkingDrum Mute	Dr/Pc	Ethnc
3206	Cajon3 Vari 46	Dr/Pc	Ethnc	3286	Djembe4 Flame	Dr/Pc	Ethnc	3366	Nakrazan Flam	Dr/Pc	Ethnc	3446	TalkingDrum Bend 1-4	Dr/Pc	Ethnc
3207	Cajon3 Vari 47	Dr/Pc	Ethnc	3287	Djembe4 Flame & Tak	Dr/Pc	Ethnc	3367	Nakrazan Tak 1	Dr/Pc	Ethnc	3447	TalkingDrum Bend 1	Dr/Pc	Ethnc
3208	Cajon3 Vari 48	Dr/Pc	Ethnc	3288	Tabla1 Bya	Dr/Pc	Ethnc	3368	Nakrazan Tak 2	Dr/Pc	Ethnc	3448	TalkingDrum Bend 2	Dr/Pc	Ethnc
3209	Cajon3 Vari 49	Dr/Pc	Ethnc	3289	Tabla1 Nah	Dr/Pc	Ethnc	3369	Nakrazan Tak 3	Dr/Pc	Ethnc	3449	TalkingDrum Bend 3	Dr/Pc	Ethnc
3210	Cajon3 Vari 50	Dr/Pc	Ethnc	3290	Tabla1 Mute	Dr/Pc	Ethnc	3370	Nakrazan GlisDn pppp	Dr/Pc	Ethnc	3450	TalkingDrum Bend 4	Dr/Pc	Ethnc
3211	Cajon3 Vari 51	Dr/Pc	Ethnc	3291	Tabla1 Combi	Dr/Pc	Ethnc	3371	Nakrazan GlisDn ppp	Dr/Pc	Ethnc	3451	Kasoor Dom	Dr/Pc	Ethnc
3212	Cajon3 Vari 52	Dr/Pc	Ethnc	3292	Tabla2 Dom & Tak	Dr/Pc	Ethnc	3372	Nakrazan GlisDn pp	Dr/Pc	Ethnc	3452	Kasoor Sak	Dr/Pc	Ethnc
3213	Cajon3 Vari 53	Dr/Pc	Ethnc	3293	Tabla2 Dom	Dr/Pc	Ethnc	3373	Nakrazan GlisDn p	Dr/Pc	Ethnc	3453	Khesbha Dom	Dr/Pc	Ethnc
3214	Cajon3 Vari 54	Dr/Pc	Ethnc	3294	Tabla2 Tak1	Dr/Pc	Ethnc	3374	Nakrazan Noise FX	Dr/Pc	Ethnc	3454	Khesbha Sak	Dr/Pc	Ethnc
3215	Cajon3 Vari 55	Dr/Pc	Ethnc	3295	Tabla2 Tak2	Dr/Pc	Ethnc	3375	Nakrazan Roll1	Dr/Pc	Ethnc	3455	Kenkeni Sw	Dr/Pc	Ethnc
3216	Cajon3 Vari 56	Dr/Pc	Ethnc	3296	Tabla2 Tak3	Dr/Pc	Ethnc	3376	Nakrazan Roll2	Dr/Pc	Ethnc	3456	Kenkeni Close	Dr/Pc	Ethnc
3217	Claves1	Dr/Pc	PC	3297	Tabla2 Tak4	Dr/Pc	Ethnc	3377	Merjal Group1 Dom	Dr/Pc	Ethnc	3457	Kenkeni Open	Dr/Pc	Ethnc
3218	Claves2	Dr/Pc	PC	3298	Tabla2 Sak	Dr/Pc	Ethnc	3378	Merjal Group1 Sak	Dr/Pc	Ethnc	3458	Neghareh Tom	Dr/Pc	Ethnc
3219	Claves3	Dr/Pc	PC	3299	Tabla2 Rak1	Dr/Pc	Ethnc	3379	Merjal Group2 Dom	Dr/Pc	Ethnc	3459	Neghareh Chap	Dr/Pc	Ethnc
3220	Whistle	Dr/Pc	PC	3300	Tabla2 Rak2	Dr/Pc	Ethnc	3380	Merjal Group2 Tak	Dr/Pc	Ethnc	3460	Neghareh Back	Dr/Pc	Ethnc
3221	Apilo Lo Short	Dr/Pc	PC	3301	Tabla2 Flam1	Dr/Pc	Ethnc	3381	Merjal Group2 Sak	Dr/Pc	Ethnc	3461	Neghareh Snap	Dr/Pc	Ethnc
3222	Apilo Hi Short	Dr/Pc	PC	3302	Tabla2 Flam2	Dr/Pc	Ethnc	3382	Zeer1 Dom	Dr/Pc	Ethnc	3462	Neghareh Eshareh	Dr/Pc	Ethnc
3223	Cowbell1	Dr/Pc	PC	3303	Tabla2 Tak Roll	Dr/Pc	Ethnc	3383	Zeer1 Flam	Dr/Pc	Ethnc	3463	Neghareh Roll	Dr/Pc	Ethnc
3224	Cowbell2	Dr/Pc	PC	3304	Tabla3 Dom	Dr/Pc	Ethnc	3384	Zeer2 Dom1	Dr/Pc	Ethnc	3464	Gosha Neghareh Lo	Dr/Pc	Ethnc
3225	Cowbell3 Sw	Dr/Pc	PC	3305	Tabla3 Tak	Dr/Pc	Ethnc	3385	Zeer2 Dom2	Dr/Pc	Ethnc	3465	Gosha Neghareh LoRim	Dr/Pc	Ethnc
3226	Cowbell3 Mute	Dr/Pc	PC	3306	Tabla3 Sak	Dr/Pc	Ethnc	3386	Zeer2 Flam	Dr/Pc	Ethnc	3466	Gosha Neghareh LoFim	Dr/Pc	Ethnc
3227	Cowbell3 Open	Dr/Pc	PC	3307	Tabla4 Dom	Dr/Pc	Ethnc	3387	Zeer3 Dom1	Dr/Pc	Ethnc	3467	Gosha Neghareh Hi1	Dr/Pc	Ethnc
3228	Cowbell4	Dr/Pc	PC	3308	Tabla4 Tak	Dr/Pc	Ethnc	3388	Zeer3 Dom2	Dr/Pc	Ethnc	3468	Gosha Neghareh Hi2	Dr/Pc	Ethnc
3229	Cowbell5	Dr/Pc	PC	3309	Tabla4 Tik	Dr/Pc	Ethnc	3389	Zeer3 Tak1	Dr/Pc	Ethnc	3469	Gosha Neghareh HiRim	Dr/Pc	Ethnc
3230	HipHop Cowbell 1 Mn	Dr/Pc	PC	3310	Tabla4 Sak	Dr/Pc	Ethnc	3390	Zeer3 Tak2	Dr/Pc	Ethnc	3470	Gosha Neghareh HiFim	Dr/Pc	Ethnc
3231	HipHop Cowbell 2 Mn	Dr/Pc	PC	3311	Tunisian Tabla Dom	Dr/Pc	Ethnc	3391	Merwas Group Dom	Dr/Pc	Ethnc	3471	Sangban Sw	Dr/Pc	Ethnc
3232	HipHop Cowbell Sw	Dr/Pc	PC	3312	Tunisian Tabla Tak1	Dr/Pc	Ethnc	3392	Merwas Group Sak	Dr/Pc	Ethnc	3472	Sangban Close	Dr/Pc	Ethnc
3233	Mambo Bell Sw	Dr/Pc	PC	3313	Tunisian Tabla Tak2	Dr/Pc	Ethnc	3393	Merwas Group Tak	Dr/Pc	Ethnc	3473	Sangban Open	Dr/Pc	Ethnc
3234	Mambo Bell1	Dr/Pc	PC	3314	Tunisian Tabla Sak	Dr/Pc	Ethnc	3394	Merwas Dom	Dr/Pc	Ethnc	3474	Dundun Bell Sw	Dr/Pc	Ethnc
3235	Mambo Bell2	Dr/Pc	PC	3315	Tunisian Tabla TakMt	Dr/Pc	Ethnc	3395	Merwas Sak	Dr/Pc	Ethnc	3475	Dundun Bell Close	Dr/Pc	Ethnc
3236	Mambo Bell Body	Dr/Pc	PC	3316	Tablah Small Dom	Dr/Pc	Ethnc	3396	Merwas Tak	Dr/Pc	Ethnc	3476	Dundun Bell Open	Dr/Pc	Ethnc
3237	ChaCha Bell Sw	Dr/Pc	PC	3317	Tablah Small Snap	Dr/Pc	Ethnc	3397	Kaser Flam	Dr/Pc	Ethnc	3477	Ainote 1	Dr/Pc	Ethnc
3238	ChaCha Bell	Dr/Pc	PC	3318	Tablah Small Sak	Dr/Pc	Ethnc	3398	Kaser Dom1	Dr/Pc	Ethnc	3478	Ainote 2	Dr/Pc	Ethnc
3239	Samba Tambourim Open	Dr/Pc	PC	3319	Tablah Small Tik	Dr/Pc	Ethnc	3399	Kaser Dom2	Dr/Pc	Ethnc	3479	Chanchiki Chan	Dr/Pc	Ethnc
3240	Samba Tambourim Slap	Dr/Pc	PC	3320	Tablah Dom	Dr/Pc	Ethnc	3400	Kaser Sak1	Dr/Pc	Ethnc	3480	Chanchiki Ki	Dr/Pc	Ethnc
3241	Samba Tambourim Mute	Dr/Pc	PC	3321	Tablah Tak1	Dr/Pc	Ethnc	3401	Kaser Sak2	Dr/Pc	Ethnc	3481	Atarigane Con	Dr/Pc	Ethnc
3242	Repique Mute	Dr/Pc	PC	3322	Tablah Tak2	Dr/Pc	Ethnc	3402	Rana Low1 Dom	Dr/Pc	Ethnc	3482	Atarigane Chi	Dr/Pc	Ethnc
3243	Repique1 Open 1-2	Dr/Pc	PC	3323	Tablah Tik1	Dr/Pc	Ethnc	3403	Rana Low2 Dom	Dr/Pc	Ethnc	3483	Wa Taiko	Dr/Pc	Ethnc
3244	Repique1 Open 1	Dr/Pc	PC	3324	Tablah Tik2	Dr/Pc	Ethnc	3404	Rana Low1 Tak	Dr/Pc	Ethnc	3484	Oo Taiko1 Don	Dr/Pc	Ethnc
3245	Repique1 Open 2	Dr/Pc	PC	3325	Tablah Tik3	Dr/Pc	Ethnc	3405	Rana Low2 Tak	Dr/Pc	Ethnc	3485	Oo Taiko1 Ka	Dr/Pc	Ethnc
3246	Repique2 St Centr	Dr/Pc	PC	3326	Tablah Sak	Dr/Pc	Ethnc	3406	Rana Low1 Sak	Dr/Pc	Ethnc	3486	Oo Taiko2 Don Soft	Dr/Pc	Ethnc
3247	Repique2 St Hd Slap	Dr/Pc	PC	3327	Tablah Big Dom	Dr/Pc	Ethnc	3407	Rana Low2 Sak	Dr/Pc	Ethnc	3487	Oo Taiko2 Don Hard	Dr/Pc	Ethnc
3248	Repique2 St Rim	Dr/Pc	PC	3328	Tablah Big Tak	Dr/Pc	Ethnc	3408	Rana High1 Dom	Dr/Pc	Ethnc	3488	Oo Taiko2 Zu	Dr/Pc	Ethnc
3249	Repique2 St Rmsht	Dr/Pc	PC	3329	Tablah Big Sak	Dr/Pc	Ethnc	3409	Rana High2 Dom	Dr/Pc	Ethnc	3489	Oo Taiko2 Ka	Dr/Pc	Ethnc
3250	Repique3 St Centr	Dr/Pc	PC	3330	Tablah Tremolo	Dr/Pc	Ethnc	3410	Rana High1 Tak	Dr/Pc	Ethnc	3490	Yagura Taiko1 Don	Dr/Pc	Ethnc
3251	Repique3 St Rmsht	Dr/Pc	PC	3331	Tabol Low Dom	Dr/Pc	Ethnc	3411	Rana High2 Tak	Dr/Pc	Ethnc	3491	Yagura Taiko1 Zu	Dr/Pc	Ethnc
3252	Repique4 Anel Open	Dr/Pc	PC	3332	Tabol Low Tak	Dr/Pc	Ethnc	3412	Rana High1 Sak	Dr/Pc	Ethnc	3492	Yagura Taiko1 Ka	Dr/Pc	Ethnc
3253	Repique4 Anel Mute	Dr/Pc	PC	3333	Tabol Low Sak	Dr/Pc	Ethnc	3413	Rana High2 Sak	Dr/Pc	Ethnc	3493	Yagura Taiko2 Don	Dr/Pc	Ethnc
3254	Repique4 Anel Rim RH	Dr/Pc	PC	3334	Tabol High Dom	Dr/Pc	Ethnc	3414	Medando1 Dom	Dr/Pc	Ethnc	3494	Yagura Taiko2 Zu	Dr/Pc	Ethnc
3255	Repique4 Anel Rim LH	Dr/Pc	PC	3335	Tabol High Tak	Dr/Pc	Ethnc	3415	Medando1 Sak	Dr/Pc	Ethnc	3495	Yagura Taiko2 Ka	Dr/Pc	Ethnc
3256	Repique5 Mao Open	Dr/Pc	PC	3336	Tabol High Sak	Dr/Pc	Ethnc	3416	Medando2 Dom	Dr/Pc	Ethnc	3496	Shime Taiko1 Ten	Dr/Pc	Ethnc
3257	Repique5 Mao Rim	Dr/Pc	PC	3337	Tabel Saaidi Dom	Dr/Pc	Ethnc	3417	Medando2 Sak	Dr/Pc	Ethnc	3497	Shime Taiko1 Tsu	Dr/Pc	Ethnc
3258	Repique5 Mao Slap	Dr/Pc	PC	3338	Tabel Saaidi Tak	Dr/Pc	Ethnc	3418	Medando Flam	Dr/Pc	Ethnc	3498	Shime Taiko1 Ku	Dr/Pc	Ethnc
3259	Berimbau Med	Dr/Pc	PC	3339	Tabel Saaidi Rim	Dr/Pc	Ethnc	3419	Mesando Dom	Dr/Pc	Ethnc	3499	Shime Taiko2 Ten	Dr/Pc	Ethnc
3260	Berimbau Hard	Dr/Pc	PC	3340	Tabel Dom	Dr/Pc	Ethnc	3420	Mesando Sak1	Dr/Pc	Ethnc	3500	Shime Taiko2 Tsu	Dr/Pc	Ethnc
3261	Stomp St	Dr/Pc	PC	3341	Tabel Tak	Dr/Pc	Ethnc	3421	Mesando Sak2	Dr/Pc	Ethnc	3501	Shime Taiko2 Ku	Dr/Pc	Ethnc
3262	Ethnic Perc 1	Dr/Pc	PC	3342	Tabel Tak Wood	Dr/Pc	Ethnc	3422	Schekanka Dom	Dr/Pc	Ethnc	3502	Tsuzumi Pon	Dr/Pc	Ethnc
3263	Ethnic Perc 2	Dr/Pc	PC	3343	Tunisian Tabel Dom1	Dr/Pc	Ethnc	3423	Schekanka Sak 1	Dr/Pc	Ethnc	3503	Tsuzumi Pu	Dr/Pc	Ethnc
3264	Ethnic Perc 3	Dr/Pc	PC	3344	Tunisian Tabel Dom2	Dr/Pc	Ethnc	3424	Schekanka Sak 2	Dr/Pc	Ethnc	3504	Tsuzumi Chi	Dr/Pc	Ethnc
3265	Ethnic Perc 4	Dr/Pc	PC	3345	Tunisian Tabel Dom3	Dr/Pc	Ethnc	3425	Ras Low Dom	Dr/Pc	Ethnc	3505	Tsuzumi Ta	Dr/Pc	Ethnc
3266	Ethnic Perc 5	Dr/Pc	PC	3346	Tunisian Tabel Tak1	Dr/Pc	Ethnc	3426	Ras Low Sak	Dr/Pc	Ethnc	3506	Oo Kawa Chon	Dr/Pc	Ethnc
3267	Ethnic Perc 6	Dr/Pc	PC	3347	Tunisian Tabel Tak2	Dr/Pc	Ethnc	3427	Ras High Dom	Dr/Pc	Ethnc	3507	Oo Kawa Tsu	Dr/Pc	Ethnc
3268	Ethnic Perc 7	Dr/Pc	PC	3348	Tunisian Tabel Tak3	Dr/Pc	Ethnc	3428	Lama Cymbal	Dr/Pc	Ethnc	3508	Oo Kawa Ton	Dr/Pc	Ethnc
3269	Ethnic Perc 8	Dr/Pc	PC	3349	Moroccan Tamtam Lo	Dr/Pc	Ethnc	3429	Mondira	Dr/Pc	Ethnc	3509	Small Tabla Dom	Dr/Pc	Ethnc
3270	Log Drum1	Dr/Pc	Ethnc	3350	Moroccan Tamtam Hi	Dr/Pc	Ethnc	3430	Tibetan Bell	Dr/Pc	Ethnc	3510	Small Tabla Snap	Dr/Pc	Ethnc
3271	Log Drum2	Dr/Pc	Ethnc	3351	Dohol Low	Dr/Pc	Ethnc	3431	Tibetan Bowl	Dr/Pc	Ethnc	3511	Small Tabla Sak	Dr/Pc	Ethnc
3272	Djembe1 Edge	Dr/Pc	Ethnc	3352	Dohol High	Dr/Pc	Ethnc	3432	Finger Cymbal Opn LH	Dr/Pc	Ethnc	3512	Small Tabla Tak	Dr/Pc	Ethnc
3273	Djembe1 Mute	Dr/Pc	Ethnc	3353	Dohol Gorz	Dr/Pc	Ethnc	3433	Finger Cymbal Mt LH	Dr/Pc	Ethnc	3513	Big Tabla Dom	Dr/Pc	Ethnc
3274	Djembe1 Open	Dr/Pc	Ethnc	3354	Dohol Gorz & Tarkeh	Dr/Pc	Ethnc	3434	Finger Cymbal Opn RH	Dr/Pc	Ethnc	3514	Big Tabla Tak	Dr/Pc	Ethnc
3275	Djembe1 Combi	Dr/Pc	Ethnc	3355	Dohol Tarkeh1	Dr/Pc	Ethnc	3435	Finger Cymbal Mt RH	Dr/Pc	Ethnc	3515	Big Tabla Sak	Dr/Pc	Ethnc
3276	Djembe2 Lo	Dr/Pc	Ethnc	3356	Dohol Tarkeh2	Dr/Pc	Ethnc	3436	Finger Cymbal Mt L&R	Dr/Pc	Ethnc	3516	Tabla Dom	Dr/Pc	Ethnc
3277	Djembe2 Slap	Dr/Pc	Ethnc	3357	Kurdish Dohol1 Lo	Dr/Pc	Ethnc	3437	Zangooreh Roll	Dr/Pc	Ethnc	3517	Tabla Tak	Dr/Pc	Ethnc
3278	Djembe2 Mute	Dr/Pc	Ethnc	3358	Kurdish Dohol1 Hi	Dr/Pc	Ethnc	3438	Zangooreh Shot	Dr/Pc	Ethnc	3518	Tabla Tak2	Dr/Pc	Ethnc
3279	Djembe3 Lo	Dr/Pc	Ethnc	3359	Kurdish Dohol2 Lo	Dr/Pc	Ethnc	3439	Shekere Shake Sw	Dr/Pc	Ethnc	3519	Tabla Tik1	Dr/Pc	Ethnc
3280	Djembe3 Slap	Dr/Pc	Ethnc	3360	Kurdish Dohol2 Hi	Dr/Pc	Ethnc	3440	Shekere Down	Dr/Pc	Ethnc	3520	Tabla Tik2	Dr/Pc	Ethnc

No.	Name	Main Category	Sub Category	No.	Name	Main Category	Sub Category	No.	Name	Main Category	Sub Category	No.	Name	Main Category	Sub Category
3521	Tabla Tik3	Dr/Pc	Ethnc	3601	Bodhran Mt Rim Clk	Dr/Pc	Ethnc	3681	Mrcn Bendir2 TikClc2	Dr/Pc	Ethnc	3761	Riq1 ShakeA 1-2	Dr/Pc	Ethnc
3522	Tabla Sak1	Dr/Pc	Ethnc	3602	Bodhran Mt Rm Clk Rs	Dr/Pc	Ethnc	3682	Mrcn Bendir2 Zim	Dr/Pc	Ethnc	3762	Riq1 ShakeA 1	Dr/Pc	Ethnc
3523	Tabla Tremolo	Dr/Pc	Ethnc	3603	Bodhran OpRimClk Rs	Dr/Pc	Ethnc	3683	Mrcn Bendir3 Dom Opn	Dr/Pc	Ethnc	3763	Riq1 ShakeA 2	Dr/Pc	Ethnc
3524	Udu Finger	Dr/Pc	Ethnc	3604	Bodhran Grace Note	Dr/Pc	Ethnc	3684	Mrcn Bendir3 Edg Opn	Dr/Pc	Ethnc	3764	Riq1 ShakeB 1-2	Dr/Pc	Ethnc
3525	Udu High	Dr/Pc	Ethnc	3605	Bodhran Harmonics	Dr/Pc	Ethnc	3685	Mrcn Bendir3 Tik Opn	Dr/Pc	Ethnc	3765	Riq1 ShakeB 1	Dr/Pc	Ethnc
3526	Udu Low	Dr/Pc	Ethnc	3606	Bodhran Drags	Dr/Pc	Ethnc	3686	Mrcn Bendir3 Tik Clc	Dr/Pc	Ethnc	3766	Riq1 ShakeB 2	Dr/Pc	Ethnc
3527	Udu Combi	Dr/Pc	Ethnc	3607	Bodhran Mute Bend	Dr/Pc	Ethnc	3687	Mrcn Bendir3 Tik Slp	Dr/Pc	Ethnc	3767	Riq1 Tremolo	Dr/Pc	Ethnc
3528	Udho Tom Hole	Dr/Pc	Ethnc	3608	Bodhran Palm Slide1	Dr/Pc	Ethnc	3688	AlgrnBendir2 Deza	Dr/Pc	Ethnc	3768	Riq2 Sak	Dr/Pc	Ethnc
3529	Udho Tom Hole Stop	Dr/Pc	Ethnc	3609	Bodhran Palm Slide2	Dr/Pc	Ethnc	3689	AlgrnBendir TakDroit	Dr/Pc	Ethnc	3769	Riq3 Dom Open	Dr/Pc	Ethnc
3530	Udho Back1	Dr/Pc	Ethnc	3610	Bodhran Palm Slide3	Dr/Pc	Ethnc	3690	AlgrnBendir TakGuche	Dr/Pc	Ethnc	3770	Riq3 Dom Close	Dr/Pc	Ethnc
3531	Udho Back2	Dr/Pc	Ethnc	3611	Bodhran Palm Slide4	Dr/Pc	Ethnc	3691	AlgrnBendir Kaf	Dr/Pc	Ethnc	3771	Riq3 Tak Open	Dr/Pc	Ethnc
3532	Udho Chap Body	Dr/Pc	Ethnc	3612	Bodhran Palm SldStrt	Dr/Pc	Ethnc	3692	Iran Bendir1 Tom	Dr/Pc	Ethnc	3772	Riq3 Tak Close1	Dr/Pc	Ethnc
3533	Udho Chap Skin	Dr/Pc	Ethnc	3613	Bodhran Stck Sld Mid	Dr/Pc	Ethnc	3693	Iran Bendir1 Slap	Dr/Pc	Ethnc	3773	Riq3 Tak Close2	Dr/Pc	Ethnc
3534	Udho Chap Top Hole	Dr/Pc	Ethnc	3614	Bodhran Stck Sld End	Dr/Pc	Ethnc	3694	Iran Bendir1 Chap1	Dr/Pc	Ethnc	3774	Riq3 Tak Snouj	Dr/Pc	Ethnc
3535	Udho Flam Skin	Dr/Pc	Ethnc	3615	Bendir Dum 1-2	Dr/Pc	Ethnc	3695	Iran Bendir1 Chap2	Dr/Pc	Ethnc	3775	Riq3 Snouj Close1	Dr/Pc	Ethnc
3536	Udho Flam Body	Dr/Pc	Ethnc	3616	Bendir Dum 1	Dr/Pc	Ethnc	3696	Iran Bendir1 Rim	Dr/Pc	Ethnc	3776	Riq3 Snouj Close2	Dr/Pc	Ethnc
3537	Udho Roll Body	Dr/Pc	Ethnc	3617	Bendir Dum 2	Dr/Pc	Ethnc	3697	Iran Bendir1 Bck&Chp	Dr/Pc	Ethnc	3777	Riq3 Sak	Dr/Pc	Ethnc
3538	Udho Roll Skin	Dr/Pc	Ethnc	3618	Bendir Tek 1-3	Dr/Pc	Ethnc	3698	Iran Bendir1 Back	Dr/Pc	Ethnc	3778	Riq3 Flam	Dr/Pc	Ethnc
3539	Jahla Group Dom	Dr/Pc	Ethnc	3619	Bendir Tek 1	Dr/Pc	Ethnc	3699	Iran Bendir1 Roll	Dr/Pc	Ethnc	3779	Riq3 Snouj Roll	Dr/Pc	Ethnc
3540	Jahla Group Sak	Dr/Pc	Ethnc	3620	Bendir Tek 2	Dr/Pc	Ethnc	3700	Iran Bendir2 Tom	Dr/Pc	Ethnc	3780	Req Sak	Dr/Pc	Ethnc
3541	Jahla Dom	Dr/Pc	Ethnc	3621	Bendir Tek 3	Dr/Pc	Ethnc	3701	Iran Bendir2 Slap	Dr/Pc	Ethnc	3781	Req Dom1	Dr/Pc	Ethnc
3542	Jahla Sak	Dr/Pc	Ethnc	3622	Bendir Teke 1-3	Dr/Pc	Ethnc	3702	Iran Bendir2 Chap1	Dr/Pc	Ethnc	3782	Req Dom2	Dr/Pc	Ethnc
3543	Barasim Dom	Dr/Pc	Ethnc	3623	Bendir Teke 1	Dr/Pc	Ethnc	3703	Iran Bendir2 Chap2	Dr/Pc	Ethnc	3783	Req Open	Dr/Pc	Ethnc
3544	Barasim Sak	Dr/Pc	Ethnc	3624	Bendir Teke 2	Dr/Pc	Ethnc	3704	Iran Bendir2 Chap Mt	Dr/Pc	Ethnc	3784	Req Slap	Dr/Pc	Ethnc
3545	Barasim Tak	Dr/Pc	Ethnc	3625	Bendir Teke 3	Dr/Pc	Ethnc	3705	Iran Bendir2 Back	Dr/Pc	Ethnc	3785	Req Sajat	Dr/Pc	Ethnc
3546	Taar Barashim1 Dom	Dr/Pc	Ethnc	3626	Bendir Teke OpenFlam	Dr/Pc	Ethnc	3706	Iran Bendir2 Bak Rim	Dr/Pc	Ethnc	3786	Req Tom & Zang	Dr/Pc	Ethnc
3547	Taar Barashim1 Sak	Dr/Pc	Ethnc	3627	Bendir Slap 1-2	Dr/Pc	Ethnc	3707	Iran Bendir2 Flam	Dr/Pc	Ethnc	3787	Req Chap Zang Open	Dr/Pc	Ethnc
3548	Taar Barashim1 Tak	Dr/Pc	Ethnc	3628	Bendir Slap 1	Dr/Pc	Ethnc	3708	Iran Bendir2 FlamTom	Dr/Pc	Ethnc	3788	Req Roll	Dr/Pc	Ethnc
3549	Taar Barashim2 Dom	Dr/Pc	Ethnc	3629	Bendir Slap 2	Dr/Pc	Ethnc	3709	Iran Bendir2 FlamBck	Dr/Pc	Ethnc	3789	Req Sak SW	Dr/Pc	Ethnc
3550	Taar Barashim2 Sak	Dr/Pc	Ethnc	3630	Bendir1 Tek Dead1-2	Dr/Pc	Ethnc	3710	Iran Bendir2 Roll	Dr/Pc	Ethnc	3790	Daf Tom	Dr/Pc	Ethnc
3551	Taar Barashim2 Tak	Dr/Pc	Ethnc	3631	Bendir1 Tek Dead1	Dr/Pc	Ethnc	3711	Iran Bendir2 RimRoll	Dr/Pc	Ethnc	3791	Daf Tom bb	Dr/Pc	Ethnc
3552	Taar Barashim3 Dom	Dr/Pc	Ethnc	3632	Bendir1 Tek Dead2	Dr/Pc	Ethnc	3712	Sagat1 R Open	Dr/Pc	Ethnc	3792	Daf Slap Open	Dr/Pc	Ethnc
3553	Taar Barashim3 Sak	Dr/Pc	Ethnc	3633	Bendir1 Teke Dead1-2	Dr/Pc	Ethnc	3713	Sagat1 R Close 1-2	Dr/Pc	Ethnc	3793	Daf Slap Mute	Dr/Pc	Ethnc
3554	Taar Barashim3 Tak	Dr/Pc	Ethnc	3634	Bendir1 Teke Dead1	Dr/Pc	Ethnc	3714	Sagat1 R Close 1	Dr/Pc	Ethnc	3794	Daf Chap	Dr/Pc	Ethnc
3555	Taar Barashim4 Dom	Dr/Pc	Ethnc	3635	Bendir1 Teke Dead2	Dr/Pc	Ethnc	3715	Sagat1 R Close 2	Dr/Pc	Ethnc	3795	Daf Back1	Dr/Pc	Ethnc
3556	Taar Barashim4 Sak	Dr/Pc	Ethnc	3636	Bendir2 Lrg Dom Opn1	Dr/Pc	Ethnc	3716	Sagat1 L Open	Dr/Pc	Ethnc	3796	Daf Back2	Dr/Pc	Ethnc
3557	Taar Barashim4 Tak	Dr/Pc	Ethnc	3637	Bendir2 Lrg Dom Opn2	Dr/Pc	Ethnc	3717	Sagat1 L Close 1-2	Dr/Pc	Ethnc	3797	Daf Chain Up1	Dr/Pc	Ethnc
3558	Sgl TaarBarashim Dom	Dr/Pc	Ethnc	3638	Bendir2 Lrg Dom Cls	Dr/Pc	Ethnc	3718	Sagat1 L Close 1	Dr/Pc	Ethnc	3798	Daf Chain Down1	Dr/Pc	Ethnc
3559	Sgl TaarBarashim Tak	Dr/Pc	Ethnc	3639	Bendir2 Lrg Sak1	Dr/Pc	Ethnc	3719	Sagat1 L Close 2	Dr/Pc	Ethnc	3799	Daf Chain Up2	Dr/Pc	Ethnc
3560	Tar Barashim Dom	Dr/Pc	Ethnc	3640	Bendir2 Lrg Sak2	Dr/Pc	Ethnc	3720	Sagat2 Sw	Dr/Pc	Ethnc	3800	Daf Chain Down2	Dr/Pc	Ethnc
3561	Tar Barashim Sak	Dr/Pc	Ethnc	3641	Bendir2 Lrg Tak Opn1	Dr/Pc	Ethnc	3721	Sagat3 Open	Dr/Pc	Ethnc	3801	Daf Chap No Chain	Dr/Pc	Ethnc
3562	Tar Barashim Tak	Dr/Pc	Ethnc	3642	Bendir2 Lrg Tak Opn2	Dr/Pc	Ethnc	3722	Sagat3 Close	Dr/Pc	Ethnc	3802	Daf Roll	Dr/Pc	Ethnc
3563	Segal Dom	Dr/Pc	Ethnc	3643	Bendir2 Lrg 1	Dr/Pc	Ethnc	3723	Sagat4 Open	Dr/Pc	Ethnc	3803	Daf Roll Chain	Dr/Pc	Ethnc
3564	Segal Tak	Dr/Pc	Ethnc	3644	Bendir2 Lrg 2	Dr/Pc	Ethnc	3724	Sagat4 Close	Dr/Pc	Ethnc	3804	Daf Roll Rim	Dr/Pc	Ethnc
3565	Twaisal1	Dr/Pc	Ethnc	3645	Bendir2 Lrg 3	Dr/Pc	Ethnc	3725	Sajat1 Open	Dr/Pc	Ethnc	3805	Daf Full Roll	Dr/Pc	Ethnc
3566	Twaisal2	Dr/Pc	Ethnc	3646	Bendir2 Lrg Flam	Dr/Pc	Ethnc	3726	Sajat1 Close	Dr/Pc	Ethnc	3806	Daf Chain Roll	Dr/Pc	Ethnc
3567	Twaisal3	Dr/Pc	Ethnc	3647	Bendir2 Lrg Flam&Tak	Dr/Pc	Ethnc	3727	Sajat2 Open	Dr/Pc	Ethnc	3807	Daf Whipping Roll	Dr/Pc	Ethnc
3568	Twaisal4	Dr/Pc	Ethnc	3648	Trsn Bendir1 Dom1	Dr/Pc	Ethnc	3728	Sajat2 Close	Dr/Pc	Ethnc	3808	Dayereh1 Tom	Dr/Pc	Ethnc
3569	Twaisal5	Dr/Pc	Ethnc	3649	Trsn Bendir1 Dom2	Dr/Pc	Ethnc	3729	Sajat2 Hawan	Dr/Pc	Ethnc	3809	Dayereh1 Tom Mute	Dr/Pc	Ethnc
3570	AsmaDavulSideBody 1-2	Dr/Pc	Ethnc	3650	Trsn Bendir1 TakOpn1	Dr/Pc	Ethnc	3730	Riq1 Dum Mute	Dr/Pc	Ethnc	3810	Dayereh1 Back	Dr/Pc	Ethnc
3571	AsmaDavulSideBody 1	Dr/Pc	Ethnc	3651	Trsn Bendir1 TakOpn2	Dr/Pc	Ethnc	3731	Riq1 Dum Open 1-2	Dr/Pc	Ethnc	3811	Dayereh1 Back Mute1	Dr/Pc	Ethnc
3572	AsmaDavulSideBody 2	Dr/Pc	Ethnc	3652	Trsn Bendir1 TakOpn3	Dr/Pc	Ethnc	3732	Riq1 Dum Open 1	Dr/Pc	Ethnc	3812	Dayereh1 Back Mute2	Dr/Pc	Ethnc
3573	AsmaDavul L Side 1-2	Dr/Pc	Ethnc	3653	Trsn Bendir1 TakClc1	Dr/Pc	Ethnc	3733	Riq1 Dum Open 2	Dr/Pc	Ethnc	3813	Dayereh1 Snap	Dr/Pc	Ethnc
3574	AsmaDavul L Side 1	Dr/Pc	Ethnc	3654	Trsn Bendir1 TakClc2	Dr/Pc	Ethnc	3734	Riq1 Tek Open 1-2	Dr/Pc	Ethnc	3814	Dayereh1 Chap	Dr/Pc	Ethnc
3575	AsmaDavul L Side 2	Dr/Pc	Ethnc	3655	Trsn Bendir1 TakClc3	Dr/Pc	Ethnc	3735	Riq1 Tek Open 1	Dr/Pc	Ethnc	3815	Dayereh1 Soft Roll	Dr/Pc	Ethnc
3576	AsmaDavul Both Sides	Dr/Pc	Ethnc	3656	Trsn Bendir1 TakClc4	Dr/Pc	Ethnc	3736	Riq1 Tek Open 2	Dr/Pc	Ethnc	3816	Dayereh1 Tom Roll	Dr/Pc	Ethnc
3577	AsmaDavul R Side 1-2	Dr/Pc	Ethnc	3657	Trsn Bendir1 TakMute	Dr/Pc	Ethnc	3737	Riq1 Tek Mute 1-2	Dr/Pc	Ethnc	3817	Dayereh1 Rim Roll	Dr/Pc	Ethnc
3578	AsmaDavul R Side 1	Dr/Pc	Ethnc	3658	Trsn Bendir1 Roll	Dr/Pc	Ethnc	3738	Riq1 Tek Mute 1	Dr/Pc	Ethnc	3818	Dayereh1 Tom	Dr/Pc	Ethnc
3579	AsmaDavul R Side 2	Dr/Pc	Ethnc	3659	Trsn Bendir2 Dom Opn	Dr/Pc	Ethnc	3739	Riq1 Tek Mute 2	Dr/Pc	Ethnc	3819	Dayereh2 Tom	Dr/Pc	Ethnc
3580	Koltuk Davul Dum 1-2	Dr/Pc	Ethnc	3660	Trsn Bendir2 Dom Cls	Dr/Pc	Ethnc	3740	Riq1 Teke Damped 1-2	Dr/Pc	Ethnc	3820	Dayereh2 Eshareh	Dr/Pc	Ethnc
3581	Koltuk Davul Dum 1	Dr/Pc	Ethnc	3661	Trsn Bendir2 TakSml	Dr/Pc	Ethnc	3741	Riq1 Teke Damped 1	Dr/Pc	Ethnc	3821	Dayereh2 Back	Dr/Pc	Ethnc
3582	Koltuk Davul Dum 2	Dr/Pc	Ethnc	3662	Riq1 Tek Opn1	Dr/Pc	Ethnc	3742	Riq1 Teke Damped 2	Dr/Pc	Ethnc	3822	Dayereh2 Snap	Dr/Pc	Ethnc
3583	KoltukDavulTekeOp1-3	Dr/Pc	Ethnc	3663	Trsn Bendir2 TakOpn2	Dr/Pc	Ethnc	3743	Riq1 Teke Flam	Dr/Pc	Ethnc	3823	Dayereh2 Flam Tom	Dr/Pc	Ethnc
3584	KoltukDavulTekeOp 1	Dr/Pc	Ethnc	3664	Trsn Bendir2 TakOpn3	Dr/Pc	Ethnc	3744	Riq1 TekMMed 1-2	Dr/Pc	Ethnc	3824	Dayereh2 Flam Back	Dr/Pc	Ethnc
3585	KoltukDavulTekeOp 2	Dr/Pc	Ethnc	3665	Trsn Bendir2 TakOpn4	Dr/Pc	Ethnc	3745	Riq1 TekMMed 1	Dr/Pc	Ethnc	3825	Dayereh2 Edge Roll	Dr/Pc	Ethnc
3586	KoltukDavulTekeOp 3	Dr/Pc	Ethnc	3666	Riq1 TekMMed 2	Dr/Pc	Ethnc	3746	Riq1 TekMMed 2	Dr/Pc	Ethnc	3826	Mazhar Dom Open	Dr/Pc	Ethnc
3587	KoltukDavulTekOp 1-3	Dr/Pc	Ethnc	3667	Trsn Bendir2 TakClc2	Dr/Pc	Ethnc	3747	Riq1 TekOpnShrt 1-2	Dr/Pc	Ethnc	3827	Mazhar Dom Close	Dr/Pc	Ethnc
3588	KoltukDavulTekOp 1	Dr/Pc	Ethnc	3668	Trsn Bendir2 TakClc3	Dr/Pc	Ethnc	3748	Riq1 TekOpnShrt 1	Dr/Pc	Ethnc	3828	Mazhar Tak Open	Dr/Pc	Ethnc
3589	KoltukDavulTekOp 2	Dr/Pc	Ethnc	3669	Trsn Bendir2 TakMute	Dr/Pc	Ethnc	3749	Riq1 TekOpnShrt 2	Dr/Pc	Ethnc	3829	Mazhar Tak Close	Dr/Pc	Ethnc
3590	KoltukDavulTekOp 3	Dr/Pc	Ethnc	3670	Trsn Bendir2 DomRoll	Dr/Pc	Ethnc	3750	Riq1 TekeOpnShrt 1-2	Dr/Pc	Ethnc	3830	Mazhar Sak Close	Dr/Pc	Ethnc
3591	KoltukDavulOpenFlam	Dr/Pc	Ethnc	3671	Mrcn Bendir1 Dom Opn	Dr/Pc	Ethnc	3751	Riq1 TekeOpnShrt 1	Dr/Pc	Ethnc	3831	Hollo Dum 1-2	Dr/Pc	Ethnc
3592	Bodhran Opn Center	Dr/Pc	Ethnc	3672	Mrcn Bendir1 Dom Cls	Dr/Pc	Ethnc	3752	Riq1 TekeOpnShrt 2	Dr/Pc	Ethnc	3832	Hollo Dum 1	Dr/Pc	Ethnc
3593	Bodhran Opn Mid	Dr/Pc	Ethnc	3673	Mrcn Bendir1 Tik Opn	Dr/Pc	Ethnc	3753	Riq1 Tek Flam	Dr/Pc	Ethnc	3833	Hollo Dum 2	Dr/Pc	Ethnc
3594	Bodhran Opn Edge	Dr/Pc	Ethnc	3674	Mrcn Bendir1 TikClc1	Dr/Pc	Ethnc	3754	Riq1 Cymbal 1-2	Dr/Pc	Ethnc	3834	Hollo Slap 1-2	Dr/Pc	Ethnc
3595	Bodhran Stck Mt Cent	Dr/Pc	Ethnc	3675	Mrcn Bendir1 TikClc2	Dr/Pc	Ethnc	3755	Riq1 Cymbal 1	Dr/Pc	Ethnc	3835	Hollo Slap 1	Dr/Pc	Ethnc
3596	Bodhran Stck Mt Mid	Dr/Pc	Ethnc	3676	Mrcn Bendir1 Zim	Dr/Pc	Ethnc	3756	Riq1 Cymbal 2	Dr/Pc	Ethnc	3836	Hollo Slap 2	Dr/Pc	Ethnc
3597	Bodhran Stck Mt Edge	Dr/Pc	Ethnc	3677	Mrcn Bendir2 Dom Opn	Dr/Pc	Ethnc	3757	Riq1 Cymbal Mute 1-2	Dr/Pc	Ethnc	3837	Hollo FingerDead 1-2	Dr/Pc	Ethnc
3598	Bodhran Finger Mt	Dr/Pc	Ethnc	3678	Mrcn Bendir2 Dom Cls	Dr/Pc	Ethnc	3758	Riq1 Cymbal Mute 1	Dr/Pc	Ethnc	3838	Hollo FingerDead 1	Dr/Pc	Ethnc
3599	Bodhran Palm Mt	Dr/Pc	Ethnc	3679	Mrcn Bendir2 Tik Opn	Dr/Pc	Ethnc	3759	Riq1 Cymbal Mute 2	Dr/Pc	Ethnc	3839	Hollo FingerDead 2	Dr/Pc	Ethnc
3600	Bodhran Op Rim Clk	Dr/Pc	Ethnc	3680	Mrcn Bendir2 TikClc1	Dr/Pc	Ethnc	3760	Riq1 Full Open	Dr/Pc	Ethnc	3840	Tombek Dum 1-2	Dr/Pc	Ethnc

No.	Name	Main Category	Sub Category
3841	Tombek Dum 1	Dr/Pc	Ethnc
3842	Tombek Dum 2	Dr/Pc	Ethnc
3843	Tombek Slap 1-2	Dr/Pc	Ethnc
3844	Tombek Slap 1	Dr/Pc	Ethnc
3845	Tombek Slap 2	Dr/Pc	Ethnc
3846	Tombek Tek 1-3	Dr/Pc	Ethnc
3847	Tombek Tek 1	Dr/Pc	Ethnc
3848	Tombek Tek 2	Dr/Pc	Ethnc
3849	Tombek Tek 3	Dr/Pc	Ethnc
3850	TombekTekeIndFng 1-3	Dr/Pc	Ethnc
3851	TombekTekeIndFng 1	Dr/Pc	Ethnc
3852	TombekTekeIndFng 2	Dr/Pc	Ethnc
3853	TombekTekeIndFng 3	Dr/Pc	Ethnc
3854	TombekTekeOthFng 1-3	Dr/Pc	Ethnc
3855	TombekTekeOthFng 1	Dr/Pc	Ethnc
3856	TombekTekeOthFng 2	Dr/Pc	Ethnc
3857	TombekTekeOthFng 3	Dr/Pc	Ethnc
3858	Tombek Tek Dead Sw	Dr/Pc	Ethnc
3859	Tombek Tek Dead	Dr/Pc	Ethnc
3860	Tombek Tek Flam	Dr/Pc	Ethnc
3861	Tombek Slap Med 1-2	Dr/Pc	Ethnc
3862	Tombek Slap Med 1	Dr/Pc	Ethnc
3863	Tombek Slap Med 2	Dr/Pc	Ethnc
3864	Tombek Teke 1-3	Dr/Pc	Ethnc
3865	Tombek Teke 1	Dr/Pc	Ethnc
3866	Tombek Teke 2	Dr/Pc	Ethnc
3867	Tombek Teke 3	Dr/Pc	Ethnc
3868	Tombak Tom1	Dr/Pc	Ethnc
3869	Tombak Tom2	Dr/Pc	Ethnc
3870	Tombak Back	Dr/Pc	Ethnc
3871	Tombak Snap	Dr/Pc	Ethnc
3872	Tombak Eshareh Left	Dr/Pc	Ethnc
3873	Tombak Eshareh Right	Dr/Pc	Ethnc
3874	Tombak Full Roll	Dr/Pc	Ethnc
3875	Tombak Timapni Roll	Dr/Pc	Ethnc
3876	Tombak Slap	Dr/Pc	Ethnc
3877	Tombak Chap1	Dr/Pc	Ethnc
3878	Tombak Chap2	Dr/Pc	Ethnc
3879	Tombak Back1	Dr/Pc	Ethnc
3880	Tombak Back2	Dr/Pc	Ethnc
3881	Tombak Pelang	Dr/Pc	Ethnc
3882	Tombak Nail Swish	Dr/Pc	Ethnc
3883	Tombak Flam1	Dr/Pc	Ethnc
3884	Tombak Flam2	Dr/Pc	Ethnc
3885	Tombak Flam & Back	Dr/Pc	Ethnc
3886	Tombak Roll Bfingers	Dr/Pc	Ethnc
3887	Tombak Tempo Tom	Dr/Pc	Ethnc
3888	Tombak Tempo Slap	Dr/Pc	Ethnc
3889	Tombak Tempo Chap	Dr/Pc	Ethnc
3890	Tombak Tempo Chap Ml	Dr/Pc	Ethnc
3891	Tombak Tempo Back	Dr/Pc	Ethnc
3892	Tombak Tempo Back Ml	Dr/Pc	Ethnc
3893	Tombak Tempo ChapFim	Dr/Pc	Ethnc
3894	Tombak Tempo Roll	Dr/Pc	Ethnc
3895	Tempo Tom	Dr/Pc	Ethnc
3896	Tempo Tom Mute	Dr/Pc	Ethnc
3897	Tempo Tom Slap	Dr/Pc	Ethnc
3898	Tempo Chap Tom	Dr/Pc	Ethnc
3899	Tempo Chap1	Dr/Pc	Ethnc
3900	Tempo Chap2	Dr/Pc	Ethnc
3901	Tempo Chap Rim	Dr/Pc	Ethnc
3902	Tempo Chap Rim Mute	Dr/Pc	Ethnc
3903	Tempo Back1	Dr/Pc	Ethnc
3904	Tempo Back2	Dr/Pc	Ethnc
3905	Tempo Back Rim	Dr/Pc	Ethnc
3906	Tempo Snap Nail	Dr/Pc	Ethnc
3907	Tempo Flam	Dr/Pc	Ethnc
3908	Tempo Flam Tom	Dr/Pc	Ethnc
3909	Tempo Flam Bak	Dr/Pc	Ethnc
3910	Tempo Roll	Dr/Pc	Ethnc
3911	Tempo Rim Roll	Dr/Pc	Ethnc
3912	Tempo Gliss Up	Dr/Pc	Ethnc
3913	Tempo Gliss Down	Dr/Pc	Ethnc
3914	Darbuka1 Dum 1-2	Dr/Pc	Ethnc
3915	Darbuka1 Dum 1	Dr/Pc	Ethnc
3916	Darbuka1 Dum 2	Dr/Pc	Ethnc
3917	Darbuka1 Teka 1-3	Dr/Pc	Ethnc
3918	Darbuka1 Teka 1	Dr/Pc	Ethnc
3919	Darbuka1 Teka 2	Dr/Pc	Ethnc
3920	Darbuka1 Teka 3	Dr/Pc	Ethnc

No.	Name	Main Category	Sub Category
3921	Darbuka1 TekB 1-3	Dr/Pc	Ethnc
3922	Darbuka1 TekB 1	Dr/Pc	Ethnc
3923	Darbuka1 TekB 2	Dr/Pc	Ethnc
3924	Darbuka1 TekB 3	Dr/Pc	Ethnc
3925	Darb1TekeIndFngA 1-3	Dr/Pc	Ethnc
3926	Darb1TekeIndFngA 1	Dr/Pc	Ethnc
3927	Darb1TekeIndFngA 2	Dr/Pc	Ethnc
3928	Darb1TekeIndFngA 3	Dr/Pc	Ethnc
3929	Darb1TekeIndFngB 1-3	Dr/Pc	Ethnc
3930	Darb1TekeIndFngB 1	Dr/Pc	Ethnc
3931	Darb1TekeIndFngB 2	Dr/Pc	Ethnc
3932	Darb1TekeIndFngB 3	Dr/Pc	Ethnc
3933	Darb1TekeOthFngA 1-3	Dr/Pc	Ethnc
3934	Darb1TekeOthFngA 1	Dr/Pc	Ethnc
3935	Darb1TekeOthFngA 2	Dr/Pc	Ethnc
3936	Darb1TekeOthFngA 3	Dr/Pc	Ethnc
3937	Darb1TekeOthFngB 1-3	Dr/Pc	Ethnc
3938	Darb1TekeOthFngB 1	Dr/Pc	Ethnc
3939	Darb1TekeOthFngB 2	Dr/Pc	Ethnc
3940	Darb1TekeOthFngB 3	Dr/Pc	Ethnc
3941	Darbuka1 Slap 1-2	Dr/Pc	Ethnc
3942	Darbuka1 Slap 1	Dr/Pc	Ethnc
3943	Darbuka1 Slap 2	Dr/Pc	Ethnc
3944	Darbuka1 SlapMed 1-2	Dr/Pc	Ethnc
3945	Darbuka1 SlapMed 1	Dr/Pc	Ethnc
3946	Darbuka1 SlapMed 2	Dr/Pc	Ethnc
3947	Darbuka1 TekeOthFlam	Dr/Pc	Ethnc
3948	Darbuka1 RollOpen	Dr/Pc	Ethnc
3949	Darbuka1 TekeOthFlam	Dr/Pc	Ethnc
3950	Darbuka1 Roll Close	Dr/Pc	Ethnc
3951	Darbuka1 TekDead 1-3	Dr/Pc	Ethnc
3952	Darbuka1 TekDead 1	Dr/Pc	Ethnc
3953	Darbuka1 TekDead 2	Dr/Pc	Ethnc
3954	Darbuka1 TekDead 3	Dr/Pc	Ethnc
3955	Darbuka1 TekDamp1-3	Dr/Pc	Ethnc
3956	Darbuka1 TekDamped 1	Dr/Pc	Ethnc
3957	Darbuka1 TekDamped 2	Dr/Pc	Ethnc
3958	Darbuka1 TekDamped 3	Dr/Pc	Ethnc
3959	Darbuka1 TekeOpen1-3	Dr/Pc	Ethnc
3960	Darbuka1 TekeOpen 1	Dr/Pc	Ethnc
3961	Darbuka1 TekeOpen 2	Dr/Pc	Ethnc
3962	Darbuka1 TekeOpen 3	Dr/Pc	Ethnc
3963	Darbuka2 Dom LH	Dr/Pc	Ethnc
3964	Darbuka2 Dom RH	Dr/Pc	Ethnc
3965	Darbuka2 Sak 1	Dr/Pc	Ethnc
3966	Darbuka2 TakLIndxFng	Dr/Pc	Ethnc
3967	Darbuka2 TakRIndxFng	Dr/Pc	Ethnc
3968	Darbuka2 TakLRingFng	Dr/Pc	Ethnc
3969	Darbuka2 TakRRingFng	Dr/Pc	Ethnc
3970	Darbuka2 Tap1	Dr/Pc	Ethnc
3971	Darbuka2 Tap2	Dr/Pc	Ethnc
3972	Darbuka2 Flam1	Dr/Pc	Ethnc
3973	Darbuka2 Flam2	Dr/Pc	Ethnc
3974	Darbuka2 Tak Roll	Dr/Pc	Ethnc
3975	Darbuka3 Dom & Tak	Dr/Pc	Ethnc
3976	Darbuka3 Tak Finger	Dr/Pc	Ethnc
3977	Darbuka3 Tak BothHnd	Dr/Pc	Ethnc
3978	Darbuka3 Tak Close	Dr/Pc	Ethnc
3979	Darbuka3 Tak Mute	Dr/Pc	Ethnc
3980	Darbuka3 Sak 1	Dr/Pc	Ethnc
3981	Darbuka3 Sak2	Dr/Pc	Ethnc
3982	Darbuka3 Sak3	Dr/Pc	Ethnc
3983	Darbuka3 Rak 1	Dr/Pc	Ethnc
3984	Darbuka3 Rak2	Dr/Pc	Ethnc
3985	Darbuka3 Gliss Down	Dr/Pc	Ethnc
3986	Darbuka3 Gliss Up	Dr/Pc	Ethnc
3987	Darbuka3 Feel Heel	Dr/Pc	Ethnc
3988	Darbuka3 Noise FX1	Dr/Pc	Ethnc
3989	Darbuka3 Noise FX2	Dr/Pc	Ethnc
3990	Darbuka3 Noise FX3	Dr/Pc	Ethnc
3991	Darbuka3 Noise FX4	Dr/Pc	Ethnc
3992	Darbuka3 Noise FX5	Dr/Pc	Ethnc
3993	Darbuka3 Noise FX6	Dr/Pc	Ethnc
3994	Darbuka3 Noise FX7	Dr/Pc	Ethnc
3995	Darbuka3 Dom Roll	Dr/Pc	Ethnc
3996	Darbuka3 Sak Roll	Dr/Pc	Ethnc
3997	Darbuka3 RllTakToDom	Dr/Pc	Ethnc
3998	Darbouka Dom	Dr/Pc	Ethnc
3999	Darbouka Tak Close1	Dr/Pc	Ethnc
4000	Darbouka Tak Close2	Dr/Pc	Ethnc

No.	Name	Main Category	Sub Category
4001	Darbouka Tak Close3	Dr/Pc	Ethnc
4002	Darbouka Tak Close4	Dr/Pc	Ethnc
4003	Darbouka Tak Open1	Dr/Pc	Ethnc
4004	Darbouka Tak Open2	Dr/Pc	Ethnc
4005	Darbouka Tak Open3	Dr/Pc	Ethnc
4006	Darbouka Tak Open4	Dr/Pc	Ethnc
4007	Darbouka Tak Open5	Dr/Pc	Ethnc
4008	Darbouka Tak Open6	Dr/Pc	Ethnc
4009	Darbouka Finger Roll	Dr/Pc	Ethnc
4010	Darbouka Hand Roll	Dr/Pc	Ethnc
4011	Zarb1 Slap	Dr/Pc	Ethnc
4012	Zarb1 Chap	Dr/Pc	Ethnc
4013	Zarb1 Back	Dr/Pc	Ethnc
4014	Zarb1 Flam Open	Dr/Pc	Ethnc
4015	Zarb1 Roll	Dr/Pc	Ethnc
4016	Zarb2 Tom	Dr/Pc	Ethnc
4017	Zarb2 Eshareh	Dr/Pc	Ethnc
4018	Zarb2 Chap	Dr/Pc	Ethnc
4019	Zarb2 Whipping	Dr/Pc	Ethnc
4020	Zarb2 Whipping	Dr/Pc	Ethnc
4021	Zarb2 Snap	Dr/Pc	Ethnc
4022	Zarb2 Full Roll	Dr/Pc	Ethnc
4023	Zarb2 Whipping Roll	Dr/Pc	Ethnc
4024	Daholla1 Dom LH	Dr/Pc	Ethnc
4025	Daholla1 Dom RH	Dr/Pc	Ethnc
4026	Daholla1 Tak 1	Dr/Pc	Ethnc
4027	Daholla1 Tak2	Dr/Pc	Ethnc
4028	Daholla1 Tak3	Dr/Pc	Ethnc
4029	Daholla1 Tak4	Dr/Pc	Ethnc
4030	Daholla1 Sak	Dr/Pc	Ethnc
4031	Daholla1 Rak1	Dr/Pc	Ethnc
4032	Daholla1 Rak2	Dr/Pc	Ethnc
4033	Daholla1 Flam1	Dr/Pc	Ethnc
4034	Daholla1 Flam2	Dr/Pc	Ethnc
4035	Daholla1 Tak Roll	Dr/Pc	Ethnc
4036	Daholla2 Dom	Dr/Pc	Ethnc
4037	Daholla2 Tak 1	Dr/Pc	Ethnc
4038	Daholla2 Tak 2	Dr/Pc	Ethnc
4039	Daholla2 Sak	Dr/Pc	Ethnc
4040	Doholla1 Dom	Dr/Pc	Ethnc
4041	Doholla1 Tak	Dr/Pc	Ethnc
4042	Doholla1 Sak	Dr/Pc	Ethnc
4043	Doholla2 Dom	Dr/Pc	Ethnc
4044	Doholla2 Tak	Dr/Pc	Ethnc
4045	Doholla2 Sak	Dr/Pc	Ethnc
4046	Naghareh Tom	Dr/Pc	Ethnc
4047	Naghareh Roll	Dr/Pc	Ethnc
4048	Naghareh Chap	Dr/Pc	Ethnc
4049	Naghareh Snap	Dr/Pc	Ethnc
4050	Naghareh Back	Dr/Pc	Ethnc
4051	Naghareh Flam 3Fing	Dr/Pc	Ethnc
4052	Kalem1 Dom1	Dr/Pc	Ethnc
4053	Kalem1 Dom2	Dr/Pc	Ethnc
4054	Kalem1 Tak Open1	Dr/Pc	Ethnc
4055	Kalem1 Tak Open2	Dr/Pc	Ethnc
4056	Kalem1 Sak1	Dr/Pc	Ethnc
4057	Kalem1 Sak2	Dr/Pc	Ethnc
4058	Kalem2 Dom1	Dr/Pc	Ethnc
4059	Kalem2 Dom2	Dr/Pc	Ethnc
4060	Kalem2 Tak Open1	Dr/Pc	Ethnc
4061	Kalem2 Tak Open2	Dr/Pc	Ethnc
4062	Kalem2 Tak Close1	Dr/Pc	Ethnc
4063	Kalem2 Tak Close2	Dr/Pc	Ethnc
4064	Kalem2 Sak	Dr/Pc	Ethnc
4065	Kalem2 Sak Close1	Dr/Pc	Ethnc
4066	Kalem2 Sak Close2	Dr/Pc	Ethnc
4067	Kalem2 Flam1	Dr/Pc	Ethnc
4068	Kalem2 Flam2	Dr/Pc	Ethnc
4069	Kalem2 Trem Dom	Dr/Pc	Ethnc
4070	Kalem2 Med Dom Opn1	Dr/Pc	Ethnc
4071	Kalem2 Med Dom Opn2	Dr/Pc	Ethnc
4072	Kalem2 Med Dom Opn3	Dr/Pc	Ethnc
4073	Kalem2 Med Dom Close	Dr/Pc	Ethnc
4074	Kalem2 Med Tak1	Dr/Pc	Ethnc
4075	Kalem2 Med Tak2	Dr/Pc	Ethnc
4076	Kalem2 Med Sak1	Dr/Pc	Ethnc
4077	Kalem2 Med Sak2	Dr/Pc	Ethnc
4078	Kalem2 Med1	Dr/Pc	Ethnc
4079	Kalem2 Med2	Dr/Pc	Ethnc
4080	Kalem2 Med Flam	Dr/Pc	Ethnc

No.	Name	Main Category	Sub Category
4081	Kalem2 Med Flam&Tak	Dr/Pc	Ethnc
4082	Kalem2 Sml Dom Opn	Dr/Pc	Ethnc
4083	Kalem2 Sml Dom Cls1	Dr/Pc	Ethnc
4084	Kalem2 Sml Dom Cls2	Dr/Pc	Ethnc
4085	Kalem2 Sml Tak1	Dr/Pc	Ethnc
4086	Kalem2 Sml Tak2	Dr/Pc	Ethnc
4087	Kalem2 Sml Sak	Dr/Pc	Ethnc
4088	Kalem2 Sml1	Dr/Pc	Ethnc
4089	Kalem2 Sml2	Dr/Pc	Ethnc
4090	Kalem2 Sml3	Dr/Pc	Ethnc
4091	Kalem2 Sml Flam	Dr/Pc	Ethnc
4092	Kalem2 Sml Flam&Tak	Dr/Pc	Ethnc
4093	Kalem2 Sml Fing Tak	Dr/Pc	Ethnc
4094	MoroccanTaarija1 Dom	Dr/Pc	Ethnc
4095	MoroccanTaarija1 Tik	Dr/Pc	Ethnc
4096	MoroccanTaarija2 Dom	Dr/Pc	Ethnc
4097	MoroccanTaarija2 Tik	Dr/Pc	Ethnc
4098	MoroccanTaarija3 Dom	Dr/Pc	Ethnc
4099	Marad Group1 Dom	Dr/Pc	Ethnc
4100	Marad Group1 Tak	Dr/Pc	Ethnc
4101	Marad Group1 Sak	Dr/Pc	Ethnc
4102	Marad Group2 Dom	Dr/Pc	Ethnc
4103	Marad Group2 Tak	Dr/Pc	Ethnc
4104	Marad Group2 Sak	Dr/Pc	Ethnc
4105	Marad1 Dom	Dr/Pc	Ethnc
4106	Marad1 Tak	Dr/Pc	Ethnc
4107	Marad1 Sak	Dr/Pc	Ethnc
4108	Marad2 Dom	Dr/Pc	Ethnc
4109	Marad2 Tak	Dr/Pc	Ethnc
4110	Marad2 Sak	Dr/Pc	Ethnc
4111	Sigal Marad Dom	Dr/Pc	Ethnc
4112	Sigal Marad Tak	Dr/Pc	Ethnc
4113	Sigal Marad Sak	Dr/Pc	Ethnc
4114	Kasik 1-2	Dr/Pc	Ethnc
4115	Kasik 1	Dr/Pc	Ethnc
4116	Kasik 2	Dr/Pc	Ethnc
4117	Kasik Flam Dead	Dr/Pc	Ethnc
4118	Kasik Flam	Dr/Pc	Ethnc
4119	Bonges Dum 1-2	Dr/Pc	Ethnc
4120	Bonges Dum 1	Dr/Pc	Ethnc
4121	Bonges Dum 2	Dr/Pc	Ethnc
4122	Bonges Tek 1-2	Dr/Pc	Ethnc
4123	Bonges Tek 1	Dr/Pc	Ethnc
4124	Bonges Tek 2	Dr/Pc	Ethnc
4125	Bonges Slap	Dr/Pc	Ethnc
4126	Bonges Tek Flam	Dr/Pc	Ethnc
4127	Bonges Tek Roll	Dr/Pc	Ethnc
4128	Bonges Flam	Dr/Pc	Ethnc
4129	Bonges Flam Hi	Dr/Pc	Ethnc
4130	AlgmGalal Daza	Dr/Pc	Ethnc
4131	AlgmGalal Daza Gch	Dr/Pc	Ethnc
4132	AlgmGalal Taka Drl	Dr/Pc	Ethnc
4133	AlgmGalal Taka Gch	Dr/Pc	Ethnc
4134	Bones 1	Dr/Pc	Ethnc
4135	Bones 2	Dr/Pc	Ethnc
4136	Bones 3	Dr/Pc	Ethnc
4137	Bones 4	Dr/Pc	Ethnc
4138	Bones 5	Dr/Pc	Ethnc
4139	Bones 6	Dr/Pc	Ethnc
4140	Bones 7	Dr/Pc	Ethnc
4141	Bones 8	Dr/Pc	Ethnc
4142	Bones 9	Dr/P	

No.	Name	Main Category	Sub Category	No.	Name	Main Category	Sub Category	No.	Name	Main Category	Sub Category	No.	Name	Main Category	Sub Category
4161	Spoons 15	Dr/Pc	Ethnc	4241	Analog Conga	Dr/Pc	PC	4321	Trap Misc 7 Mn	Dr/Pc	PC	4401	Bd Normal 2L	Dr/Pc	Kick
4162	Spoons 16	Dr/Pc	Ethnc	4242	Cowbell T8	Dr/Pc	PC	4322	Trap Misc 8 St	Dr/Pc	PC	4402	Bd Normal 2R	Dr/Pc	Kick
4163	Spoons 17	Dr/Pc	Ethnc	4243	T8 Cowbell Ac	Dr/Pc	PC	4323	Trap Misc 9 St	Dr/Pc	PC	4403	Bd Funk S1-2	Dr/Pc	Kick
4164	Spoons 18	Dr/Pc	Ethnc	4244	T8 Cowbell NA	Dr/Pc	PC	4324	Trap Misc Sw	Dr/Pc	PC	4404	Bd Funk 1St	Dr/Pc	Kick
4165	Spoons 19	Dr/Pc	Ethnc	4245	S&H T8 Cowbell	Dr/Pc	PC	4325	HipHop Misc Mn	Dr/Pc	PC	4405	Bd Funk 2St	Dr/Pc	Kick
4166	Spoons 20	Dr/Pc	Ethnc	4246	Elec T8 Cowbell	Dr/Pc	PC	4326	EDM Misc 01 St	Dr/Pc	PC	4406	Bd Funk L1-2	Dr/Pc	Kick
4167	Spoons 21	Dr/Pc	Ethnc	4247	Cowbell RX11	Dr/Pc	PC	4327	EDM Misc 02 St	Dr/Pc	PC	4407	Bd Funk R1-2	Dr/Pc	Kick
4168	Spoons 22	Dr/Pc	Ethnc	4248	Cowbell AnCR	Dr/Pc	PC	4328	EDM Misc 03 St	Dr/Pc	PC	4408	Bd Funk 1 L	Dr/Pc	Kick
4169	Spoons 23	Dr/Pc	Ethnc	4249	Electric Cowbell	Dr/Pc	PC	4329	EDM Misc 04 St	Dr/Pc	PC	4409	Bd Funk 1 R	Dr/Pc	Kick
4170	Spoons 24	Dr/Pc	Ethnc	4250	Analog Shaker	Dr/Pc	PC	4330	EDM Misc 05 St	Dr/Pc	PC	4410	Bd Funk 2 L	Dr/Pc	Kick
4171	Spoons 25	Dr/Pc	Ethnc	4251	PC Shaker1	Dr/Pc	PC	4331	EDM Misc 06 St	Dr/Pc	PC	4411	Bd Funk 2 R	Dr/Pc	Kick
4172	Spoons Roll 1	Dr/Pc	Ethnc	4252	PC Shaker2	Dr/Pc	PC	4332	EDM Misc 07 St	Dr/Pc	PC	4412	Bd High St	Dr/Pc	Kick
4173	Spoons Roll 2	Dr/Pc	Ethnc	4253	Elec Shaker1 St	Dr/Pc	PC	4333	EDM Misc 08 St	Dr/Pc	PC	4413	Bd High L	Dr/Pc	Kick
4174	Spoons Roll 3	Dr/Pc	Ethnc	4254	Elec Shaker2 St	Dr/Pc	PC	4334	EDM Misc 09 St	Dr/Pc	PC	4414	Bd High R	Dr/Pc	Kick
4175	Spoons Roll 4	Dr/Pc	Ethnc	4255	Elec Shaker3 St	Dr/Pc	PC	4335	EDM Misc 10 St	Dr/Pc	PC	4415	Bd Low St	Dr/Pc	Kick
4176	Manjor Normal	Dr/Pc	Ethnc	4256	Elec Shaker4 St	Dr/Pc	PC	4336	EDM Misc 11 St	Dr/Pc	PC	4416	Bd Low L	Dr/Pc	Kick
4177	Arabic Zalgouta Opn	Dr/Pc	Ethnc	4257	Elec Shaker5 St	Dr/Pc	PC	4337	EDM Misc 12 Mn	Dr/Pc	PC	4417	Bd Low R	Dr/Pc	Kick
4178	Arabic Zalgouta Cls	Dr/Pc	Ethnc	4258	Tambourine RX5	Dr/Pc	PC	4338	House Misc 1 St	Dr/Pc	PC	4418	Bd H Son St	Dr/Pc	Kick
4179	Clap T9-1	Dr/Pc	PC	4259	Tambourine AnCR	Dr/Pc	PC	4339	House Misc 2 St	Dr/Pc	PC	4419	Bd H Son L	Dr/Pc	Kick
4180	Clap T9-2	Dr/Pc	PC	4260	Electric Tambourine1	Dr/Pc	PC	4340	House Misc 3 St	Dr/Pc	PC	4420	Bd H Son R	Dr/Pc	Kick
4181	T9 ClapSD	Dr/Pc	PC	4261	Electric Tambourine2	Dr/Pc	PC	4341	House Misc 4 St	Dr/Pc	PC	4421	Bd L Son St	Dr/Pc	Kick
4182	Hard T9 Clap	Dr/Pc	PC	4262	Electric Tambourine3	Dr/Pc	PC	4342	House Misc 5 St	Dr/Pc	PC	4422	Bd L Son L	Dr/Pc	Kick
4183	T8 Clap Ac	Dr/Pc	PC	4263	Electric Tambourine4	Dr/Pc	PC	4343	House Misc 6 Mn	Dr/Pc	PC	4423	Bd L Son R	Dr/Pc	Kick
4184	T8 Clap NA	Dr/Pc	PC	4264	Elec Stick1 Mn	Dr/Pc	PC	4344	Electro Misc 01 M	Dr/Pc	PC	4424	Bd Funk Son St	Dr/Pc	Kick
4185	S&H T8 Clap	Dr/Pc	PC	4265	Elec Stick2 Mn	Dr/Pc	PC	4345	Electro Misc 02 St	Dr/Pc	PC	4425	Bd Funk Son L	Dr/Pc	Kick
4186	Elec T8 Clap	Dr/Pc	PC	4266	Elec Stick Sw	Dr/Pc	PC	4346	Electro Misc 03 St	Dr/Pc	PC	4426	Bd Funk Son R	Dr/Pc	Kick
4187	Clap AnSm	Dr/Pc	PC	4267	Elec Wood Block1 St	Dr/Pc	PC	4347	Electro Misc 04 St	Dr/Pc	PC	4427	Bd Rock1 St	Dr/Pc	Kick
4188	Electric Clap1	Dr/Pc	PC	4268	Elec Wood Block2 St	Dr/Pc	PC	4348	Electro Misc 05 St	Dr/Pc	PC	4428	Bd Rock1 L	Dr/Pc	Kick
4189	Electric Clap2	Dr/Pc	PC	4269	Elec Wood Block3 St	Dr/Pc	PC	4349	Electro Misc 06 St	Dr/Pc	PC	4429	Bd Rock1 R	Dr/Pc	Kick
4190	RX11 Clap	Dr/Pc	PC	4270	Elec Wood Block4 St	Dr/Pc	PC	4350	Electro Misc 07 St	Dr/Pc	PC	4430	Bd Rock2 St	Dr/Pc	Kick
4191	Clap Long Ambi St	Dr/Pc	PC	4271	WB Fresh Elec St	Dr/Pc	PC	4351	Electro Misc 08 St	Dr/Pc	PC	4431	Bd Rock2 L	Dr/Pc	Kick
4192	Clap Short Ambi St	Dr/Pc	PC	4272	MaracasT8-1	Dr/Pc	PC	4352	Electro Misc 09 St	Dr/Pc	PC	4432	Bd Rock2 R	Dr/Pc	Kick
4193	Clap Elec 1	Dr/Pc	PC	4273	MaracasT8-2	Dr/Pc	PC	4353	Electro Misc 10 St	Dr/Pc	PC	4433	Bd Dry1	Dr/Pc	Kick
4194	Clap Elec 2	Dr/Pc	PC	4274	MaracasT8-3	Dr/Pc	PC	4354	Electro Misc 11 St	Dr/Pc	PC	4434	Bd Dry2	Dr/Pc	Kick
4195	Dub Clap St	Dr/Pc	PC	4275	Electric Maracas	Dr/Pc	PC	4355	Electro Misc 12 St	Dr/Pc	PC	4435	Bd Pop	Dr/Pc	Kick
4196	Trap Clap 1 St	Dr/Pc	PC	4276	Claves T8-1	Dr/Pc	PC	4356	Electro Misc 13 St	Dr/Pc	PC	4436	Bd Var1	Dr/Pc	Kick
4197	Trap Clap 2 Mn	Dr/Pc	PC	4277	Claves T8-2	Dr/Pc	PC	4357	Rattle Mn	Dr/Pc	PC	4437	Bd Var2	Dr/Pc	Kick
4198	Trap Clap 3 St	Dr/Pc	PC	4278	Elec T8 Claves	Dr/Pc	PC	4358	HipHop Smack St	Dr/Pc	PC	4438	Bd Room1	Dr/Pc	Kick
4199	Trap Clap 4 Mn	Dr/Pc	PC	4279	Electric Triangle	Dr/Pc	PC	4359	HipHop Thock St	Dr/Pc	PC	4439	Bd Room2	Dr/Pc	Kick
4200	Trap Clap 5 Mn	Dr/Pc	PC	4280	HipHop Triangle Mn	Dr/Pc	PC	4360	Tick 01 St	Dr/Pc	PC	4440	Bd Room3	Dr/Pc	Kick
4201	Trap Clap Sw	Dr/Pc	PC	4281	House Triangle Mn	Dr/Pc	PC	4361	Tick 02 St	Dr/Pc	PC	4441	Bd Jazz1-2St	Dr/Pc	Kick
4202	HipHop Clap 1 St	Dr/Pc	PC	4282	Elec Cabasa1 Mn	Dr/Pc	PC	4362	T8 Sub-1 M	Dr/Pc	PC	4442	Bd Jazz1-2L	Dr/Pc	Kick
4203	HipHop Clap 2 St	Dr/Pc	PC	4283	Elec Cabasa2 Mn	Dr/Pc	PC	4363	T8 Sub-2 M	Dr/Pc	PC	4443	Bd Jazz1-2R	Dr/Pc	Kick
4204	EDM Clap St	Dr/Pc	PC	4284	House Cabasa1 Mn	Dr/Pc	PC	4364	T8 Sub-3 M	Dr/Pc	PC	4444	Bd Jazz1St	Dr/Pc	Kick
4205	House Clap 1 St	Dr/Pc	PC	4285	House Cabasa2 Mn	Dr/Pc	PC	4365	T8 Sub-4 M	Dr/Pc	PC	4445	Bd Jazz1L	Dr/Pc	Kick
4206	House Clap 2 St	Dr/Pc	PC	4286	Analog Click	Dr/Pc	PC	4366	T8 Sub-5 M	Dr/Pc	PC	4446	Bd Jazz1R	Dr/Pc	Kick
4207	House Clap 3 St	Dr/Pc	PC	4287	HipHop Flex1	Dr/Pc	PC	4367	Bd Snap 1-2	Dr/Pc	Kick	4447	Bd Jazz2St	Dr/Pc	Kick
4208	House Clap 4 St	Dr/Pc	PC	4288	HipHop Flex2	Dr/Pc	PC	4368	Bd Snap 1	Dr/Pc	Kick	4448	Bd Jazz2L	Dr/Pc	Kick
4209	Electro Clap 1 St	Dr/Pc	PC	4289	Trap Perc 1 St	Dr/Pc	PC	4369	Bd Snap 2	Dr/Pc	Kick	4449	Bd Jazz2R	Dr/Pc	Kick
4210	Electro Clap 2 St	Dr/Pc	PC	4290	Trap Perc 2 St	Dr/Pc	PC	4370	Bd Snap L1-2	Dr/Pc	Kick	4450	Bd FK Jazz St	Dr/Pc	Kick
4211	HipHop Clap1	Dr/Pc	PC	4291	EDM Perc St	Dr/Pc	PC	4371	Bd Snap R1-2	Dr/Pc	Kick	4451	Bd FK Jazz L	Dr/Pc	Kick
4212	HipHop Clap2	Dr/Pc	PC	4292	House Perc St	Dr/Pc	PC	4372	Bd Snap L1	Dr/Pc	Kick	4452	Bd FK Jazz R	Dr/Pc	Kick
4213	HipHop Clap3	Dr/Pc	PC	4293	Electro Perc 1 St	Dr/Pc	PC	4373	Bd Snap L2	Dr/Pc	Kick	4453	Bd PL Jazz HiSna Sw	Dr/Pc	Snare
4214	HipHop Clap4	Dr/Pc	PC	4294	Electro Perc 2 St	Dr/Pc	PC	4374	Bd Snap R1	Dr/Pc	Kick	4454	Bd PowerA 1-2St	Dr/Pc	Kick
4215	HipHop Clap5	Dr/Pc	PC	4295	Electro Perc 3 St	Dr/Pc	PC	4375	Bd Snap R2	Dr/Pc	Kick	4455	Bd PowerA 1-2L	Dr/Pc	Kick
4216	HipHop Clap6	Dr/Pc	PC	4296	Brip 1 St	Dr/Pc	PC	4376	Bd Tight 1-2	Dr/Pc	Kick	4456	Bd PowerA 1-2R	Dr/Pc	Kick
4217	HipHop Clap7	Dr/Pc	PC	4297	Brip 2 St	Dr/Pc	PC	4377	Bd Tight 1	Dr/Pc	Kick	4457	Bd PowerA 1St	Dr/Pc	Kick
4218	HipHop Clap8	Dr/Pc	PC	4298	HipHop Ctunk St	Dr/Pc	PC	4378	Bd Tight 2	Dr/Pc	Kick	4458	Bd PowerA 1L	Dr/Pc	Kick
4219	HipHop Clap9	Dr/Pc	PC	4299	Lipp Flex 1 Mn	Dr/Pc	PC	4379	Bd Tight L1-2	Dr/Pc	Kick	4459	Bd PowerA 1R	Dr/Pc	Kick
4220	HipHop Clap10	Dr/Pc	PC	4300	Lipp Flex 2 Mn	Dr/Pc	PC	4380	Bd Tight R1-2	Dr/Pc	Kick	4460	Bd PowerA 2St	Dr/Pc	Kick
4221	HipHop Clap11	Dr/Pc	PC	4301	Lipp Flex 3 Mn	Dr/Pc	PC	4381	Bd Tight L1	Dr/Pc	Kick	4461	Bd PowerA 2L	Dr/Pc	Kick
4222	HipHop Clap12	Dr/Pc	PC	4302	Lipp Flex 4 Mn	Dr/Pc	PC	4382	Bd Tight L2	Dr/Pc	Kick	4462	Bd PowerA 2R	Dr/Pc	Kick
4223	HipHop Clap13	Dr/Pc	PC	4303	Lipp Flex Sw1	Dr/Pc	PC	4383	Bd Tight R1	Dr/Pc	Kick	4463	Bd PowerB 1-2St	Dr/Pc	Kick
4224	HipHop Clap14	Dr/Pc	PC	4304	Lipp Flex Sw2	Dr/Pc	PC	4384	Bd Tight R2	Dr/Pc	Kick	4464	Bd PowerB 1-2L	Dr/Pc	Kick
4225	Snap Digital St	Dr/Pc	PC	4305	Dub Misc 01 St	Dr/Pc	PC	4385	Bd Ambience 1-2	Dr/Pc	Kick	4465	Bd PowerB 1-2R	Dr/Pc	Kick
4226	Snap & Clap St	Dr/Pc	PC	4306	Dub Misc 02 St	Dr/Pc	PC	4386	Bd Ambience 1	Dr/Pc	Kick	4466	Bd PowerB 1St	Dr/Pc	Kick
4227	Snap Long Ambi St	Dr/Pc	PC	4307	Dub Misc 03 St	Dr/Pc	PC	4387	Bd Ambience 2	Dr/Pc	Kick	4467	Bd PowerB 1L	Dr/Pc	Kick
4228	Snap Smith Snap St	Dr/Pc	PC	4308	Dub Misc 04 St	Dr/Pc	PC	4388	Bd Ambience L1-2	Dr/Pc	Kick	4468	Bd PowerB 1R	Dr/Pc	Kick
4229	HipHop Snap1	Dr/Pc	PC	4309	Dub Misc 05 St	Dr/Pc	PC	4389	Bd Ambience R1-2	Dr/Pc	Kick	4469	Bd PowerB 2St	Dr/Pc	Kick
4230	HipHop Snap2	Dr/Pc	PC	4310	Dub Misc 06 St	Dr/Pc	PC	4390	Bd Ambience L1	Dr/Pc	Kick	4470	Bd PowerB 2L	Dr/Pc	Kick
4231	Conga T8	Dr/Pc	PC	4311	Dub Misc 07 St	Dr/Pc	PC	4391	Bd Ambience L2	Dr/Pc	Kick	4471	Bd PowerB 2R	Dr/Pc	Kick
4232	T8 Conga Ac H	Dr/Pc	PC	4312	Dub Misc 08 St	Dr/Pc	PC	4392	Bd Ambience R1	Dr/Pc	Kick	4472	Bd Maple Close 1-2St	Dr/Pc	Kick
4233	T8 Conga Ac M	Dr/Pc	PC	4313	Dub Misc 09 St	Dr/Pc	PC	4393	Bd Ambience R2	Dr/Pc	Kick	4473	Bd Maple Close 1-2 L	Dr/Pc	Kick
4234	T8 Conga Ac L	Dr/Pc	PC	4314	Dub Misc 10 St	Dr/Pc	PC	4394	Bd Normal S1-2	Dr/Pc	Kick	4474	Bd Maple Close 1-2 R	Dr/Pc	Kick
4235	T8 Conga NA H	Dr/Pc	PC	4315	Trap Misc 1 St	Dr/Pc	PC	4395	Bd Normal 1St	Dr/Pc	Kick	4475	Bd Maple Close 1 St	Dr/Pc	Kick
4236	T8 Conga NA M	Dr/Pc	PC	4316	Trap Misc 2 St	Dr/Pc	PC	4396	Bd Normal 2St	Dr/Pc	Kick	4476	Bd Maple Close 1 L	Dr/Pc	Kick
4237	T8 Conga NA L	Dr/Pc	PC	4317	Trap Misc 3 St	Dr/Pc	PC	4397	Bd Normal L1-2	Dr/Pc	Kick	4477	Bd Maple Close 1 R	Dr/Pc	Kick
4238	S&H T8 CongaH	Dr/Pc	PC	4318	Trap Misc 4 St	Dr/Pc	PC	4398	Bd Normal R1-2	Dr/Pc	Kick	4478	Bd Maple Close 2 St	Dr/Pc	Kick
4239	S&H T8 CongaM	Dr/Pc	PC	4319	Trap Misc 5 St	Dr/Pc	PC	4399	Bd Normal 1L	Dr/Pc	Kick	4479	Bd Maple Close 2 L	Dr/Pc	Kick
4240	S&H T8 CongaL	Dr/Pc	PC	4320	Trap Misc 6 St	Dr/Pc	PC	4400	Bd Normal 1R	Dr/Pc	Kick	4480	Bd Maple Close 2 R	Dr/Pc	Kick

No.	Name	Main Category	Sub Category	No.	Name	Main Category	Sub Category	No.	Name	Main Category	Sub Category	No.	Name	Main Category	Sub Category
4481	Bd Maple Open 1-2 St	Dr/Pc	Kick	4561	Bd T9-2	Dr/Pc	Kick	4641	Bd ElecComp1	Dr/Pc	Kick	4721	HipHop BD 1 St	Dr/Pc	Kick
4482	Bd Maple Open 1-2 L	Dr/Pc	Kick	4562	Bd T9-3	Dr/Pc	Kick	4642	Bd ElecComp2	Dr/Pc	Kick	4722	HipHop BD 2 Mn	Dr/Pc	Kick
4483	Bd Maple Open 1-2 R	Dr/Pc	Kick	4563	Bd T9-4	Dr/Pc	Kick	4643	Bd ElecComp3	Dr/Pc	Kick	4723	HipHop BD 3 Mn	Dr/Pc	Kick
4484	Bd Maple Open 1 St	Dr/Pc	Kick	4564	Bd T9 Hd1	Dr/Pc	Kick	4644	Bd ElecFX1	Dr/Pc	Kick	4724	HipHop BD 4 Mn	Dr/Pc	Kick
4485	Bd Maple Open 1 L	Dr/Pc	Kick	4565	Bd T9 Hd2	Dr/Pc	Kick	4645	Bd ElecFX2	Dr/Pc	Kick	4725	HipHop BD 5 Mn	Dr/Pc	Kick
4486	Bd Maple Open 1 R	Dr/Pc	Kick	4566	Bd T9 Hd3	Dr/Pc	Kick	4646	Bd ElecGate	Dr/Pc	Kick	4726	Sd Bld S1-4	Dr/Pc	Snare
4487	Bd Maple Open 2 St	Dr/Pc	Kick	4567	T9 BD 1-1	Dr/Pc	Kick	4647	Bd ElecClick	Dr/Pc	Kick	4727	Sd Bld S1-3	Dr/Pc	Snare
4488	Bd Maple Open 1-2 R	Dr/Pc	Kick	4568	T9 BD 1-2	Dr/Pc	Kick	4648	Bd ElecPower1	Dr/Pc	Kick	4728	Sd Bld S2-4	Dr/Pc	Snare
4489	Bd Maple Open 2 R	Dr/Pc	Kick	4569	T9 BD 1-3	Dr/Pc	Kick	4649	Bd ElecPower2	Dr/Pc	Kick	4729	Sd Bld S1-2	Dr/Pc	Snare
4490	Bd Oak Open 1-2 St	Dr/Pc	Kick	4570	T9 BD 1-4	Dr/Pc	Kick	4650	Bd Techno L	Dr/Pc	Kick	4730	Sd Bld S2-3	Dr/Pc	Snare
4491	Bd Oak Open 1-2 L	Dr/Pc	Kick	4571	T9 BD 2-1	Dr/Pc	Kick	4651	Bd Techno Q	Dr/Pc	Kick	4731	Sd Bld S3-4	Dr/Pc	Snare
4492	Bd Oak Open 1-2 R	Dr/Pc	Kick	4572	T9 BD 2-2	Dr/Pc	Kick	4652	Bd NeoKick	Dr/Pc	Kick	4732	Sd Bld S1	Dr/Pc	Snare
4493	Bd Oak Open 1 St	Dr/Pc	Kick	4573	T9 BD 2-3	Dr/Pc	Kick	4653	Bd HrdSpecial	Dr/Pc	Kick	4733	Sd Bld S2	Dr/Pc	Snare
4494	Bd Oak Open 1 L	Dr/Pc	Kick	4574	T9 BD 2-4	Dr/Pc	Kick	4654	Bd Hybrid1	Dr/Pc	Kick	4734	Sd Bld S3	Dr/Pc	Snare
4495	Bd Oak Open 1 R	Dr/Pc	Kick	4575	S&H T9 BD 1	Dr/Pc	Kick	4655	Bd Hybrid2	Dr/Pc	Kick	4735	Sd Bld S4	Dr/Pc	Snare
4496	Bd Oak Open 2 St	Dr/Pc	Kick	4576	S&H T9 BD 2	Dr/Pc	Kick	4656	Bd NewPop1	Dr/Pc	Kick	4736	Sd Bld L1-4	Dr/Pc	Snare
4497	Bd Oak Open 2 L	Dr/Pc	Kick	4577	Hard T9 BD	Dr/Pc	Kick	4657	Bd NewPop2	Dr/Pc	Kick	4737	Sd Bld R1-4	Dr/Pc	Snare
4498	Bd Oak Open 2 R	Dr/Pc	Kick	4578	Hard T9 BD Revrese	Dr/Pc	Kick	4658	Bd NewPop3	Dr/Pc	Kick	4738	Sd Bld L1	Dr/Pc	Snare
4499	Bd Oak Close 1-2 St	Dr/Pc	Kick	4579	Elec T9 BD	Dr/Pc	Kick	4659	Bd NewPop4	Dr/Pc	Kick	4739	Sd Bld L2	Dr/Pc	Snare
4500	Bd Oak Close 1-2 L	Dr/Pc	Kick	4580	Bd T8-1	Dr/Pc	Kick	4660	Bd Slack1	Dr/Pc	Kick	4740	Sd Bld L3	Dr/Pc	Snare
4501	Bd Oak Close 1-2 R	Dr/Pc	Kick	4581	Bd T8-2	Dr/Pc	Kick	4661	Bd Slack2	Dr/Pc	Kick	4741	Sd Bld L4	Dr/Pc	Snare
4502	Bd Oak Close 1 St	Dr/Pc	Kick	4582	Bd T8-3	Dr/Pc	Kick	4662	Bd Slack3	Dr/Pc	Kick	4742	Sd Bld R1	Dr/Pc	Snare
4503	Bd Oak Close 1 L	Dr/Pc	Kick	4583	T8 BD Ac 1	Dr/Pc	Kick	4663	Bd Slack4	Dr/Pc	Kick	4743	Sd Bld R2	Dr/Pc	Snare
4504	Bd Oak Close 1 R	Dr/Pc	Kick	4584	T8 BD Ac 2	Dr/Pc	Kick	4664	Bd Slack5	Dr/Pc	Kick	4744	Sd Bld R3	Dr/Pc	Snare
4505	Bd Oak Close 2 St	Dr/Pc	Kick	4585	T8 BD Ac 3	Dr/Pc	Kick	4665	Bd Slack6	Dr/Pc	Kick	4745	Sd Bld R4	Dr/Pc	Snare
4506	Bd Oak Close 2 L	Dr/Pc	Kick	4586	T8 BD NA 1	Dr/Pc	Kick	4666	Bd Slack7	Dr/Pc	Kick	4746	Sd Soul S1-4	Dr/Pc	Snare
4507	Bd Oak Close 2 R	Dr/Pc	Kick	4587	T8 BD NA 2	Dr/Pc	Kick	4667	Bd TB Basic	Dr/Pc	Kick	4747	Sd Soul S1-3	Dr/Pc	Snare
4508	Bd Njz Closed 1-2 St	Dr/Pc	Kick	4588	S&H T8 BD	Dr/Pc	Kick	4668	Bd TB Comp	Dr/Pc	Kick	4748	Sd Soul S2-4	Dr/Pc	Snare
4509	Bd Njz Closed 1-2 L	Dr/Pc	Kick	4589	Elec T8 BD	Dr/Pc	Kick	4669	Bd TB PDist1	Dr/Pc	Kick	4749	Sd Soul S1-2	Dr/Pc	Snare
4510	Bd Njz Closed 1-2 R	Dr/Pc	Kick	4590	Bd AnSm	Dr/Pc	Kick	4670	Bd TB PDist2	Dr/Pc	Kick	4750	Sd Soul S2-3	Dr/Pc	Snare
4511	Bd Njz Closed 1 St	Dr/Pc	Kick	4591	Bd AnCR	Dr/Pc	Kick	4671	Bd EDM01	Dr/Pc	Kick	4751	Sd Soul S3-4	Dr/Pc	Snare
4512	Bd Njz Closed 1 L	Dr/Pc	Kick	4592	Bd RX11	Dr/Pc	Kick	4672	Bd EDM02	Dr/Pc	Kick	4752	Sd Soul L1-4	Dr/Pc	Snare
4513	Bd Njz Closed 1 R	Dr/Pc	Kick	4593	Bd Human1	Dr/Pc	Kick	4673	Bd EDM03	Dr/Pc	Kick	4753	Sd Soul R1-4	Dr/Pc	Snare
4514	Bd Njz Closed 2 St	Dr/Pc	Kick	4594	Bd Human2	Dr/Pc	Kick	4674	Bd EDM04	Dr/Pc	Kick	4754	Sd Soul S1	Dr/Pc	Snare
4515	Bd Njz Closed 2 L	Dr/Pc	Kick	4595	Bd Brnp	Dr/Pc	Kick	4675	Bd EDM05	Dr/Pc	Kick	4755	Sd Soul S2	Dr/Pc	Snare
4516	Bd Njz Closed 2 R	Dr/Pc	Kick	4596	Bd BlpHd	Dr/Pc	Kick	4676	Bd EDM06	Dr/Pc	Kick	4756	Sd Soul S3	Dr/Pc	Snare
4517	Bd Njz Open 1-2 St	Dr/Pc	Kick	4597	Bd Jungle1	Dr/Pc	Kick	4677	Bd EDM07	Dr/Pc	Kick	4757	Sd Soul S4	Dr/Pc	Snare
4518	Bd Njz Open 1-2 L	Dr/Pc	Kick	4598	Bd Jungle2	Dr/Pc	Kick	4678	Bd EDM08	Dr/Pc	Kick	4758	Sd Soul L1	Dr/Pc	Snare
4519	Bd Njz Open 1-2 R	Dr/Pc	Kick	4599	Bd Jungle3	Dr/Pc	Kick	4679	Bd EDM09	Dr/Pc	Kick	4759	Sd Soul L2	Dr/Pc	Snare
4520	Bd Njz Open 1 St	Dr/Pc	Kick	4600	Bd D&B1	Dr/Pc	Kick	4680	Bd EDM10	Dr/Pc	Kick	4760	Sd Soul L3	Dr/Pc	Snare
4521	Bd Njz Open 1 L	Dr/Pc	Kick	4601	Bd D&B2	Dr/Pc	Kick	4681	Bd EDM Gate	Dr/Pc	Kick	4761	Sd Soul L4	Dr/Pc	Snare
4522	Bd Njz Open 1 R	Dr/Pc	Kick	4602	Bd R&B1	Dr/Pc	Kick	4682	Bd LongBass	Dr/Pc	Kick	4762	Sd Soul R1	Dr/Pc	Snare
4523	Bd Njz Open 2 St	Dr/Pc	Kick	4603	Bd R&B2	Dr/Pc	Kick	4683	Bd Body1 Hard	Dr/Pc	Kick	4763	Sd Soul R2	Dr/Pc	Snare
4524	Bd Njz Open 2 L	Dr/Pc	Kick	4604	Bd Hip Deep	Dr/Pc	Kick	4684	Bd Body1 Soft	Dr/Pc	Kick	4764	Sd Soul R3	Dr/Pc	Snare
4525	Bd Njz Open 2 R	Dr/Pc	Kick	4605	Bd Break Deep	Dr/Pc	Kick	4685	Bd Body2	Dr/Pc	Kick	4765	Sd Soul R4	Dr/Pc	Snare
4526	Bd GranCasaA Open St	Dr/Pc	Kick	4606	Bd Break1	Dr/Pc	Kick	4686	Bd Body3	Dr/Pc	Kick	4766	Sd Strong S1-4	Dr/Pc	Snare
4527	Bd GranCasaA Open L	Dr/Pc	Kick	4607	Bd Break2	Dr/Pc	Kick	4687	Dub BD 1 Mn	Dr/Pc	Kick	4767	Sd Strong S1-3	Dr/Pc	Snare
4528	Bd GranCasaA Open R	Dr/Pc	Kick	4608	Bd Break Heavy	Dr/Pc	Kick	4688	Dub BD 2 St	Dr/Pc	Kick	4768	Sd Strong S2-4	Dr/Pc	Snare
4529	Bd GranCasaA Mute St	Dr/Pc	Kick	4609	Bd Break Hard	Dr/Pc	Kick	4689	Dub BD 3 Mn	Dr/Pc	Kick	4769	Sd Strong S1-2	Dr/Pc	Snare
4530	Bd GranCasaA Mute L	Dr/Pc	Kick	4610	Bd Distortion1	Dr/Pc	Kick	4690	Dub BD 4 Mn	Dr/Pc	Kick	4770	Sd Strong S2-3	Dr/Pc	Snare
4531	Bd GranCasaA Mute R	Dr/Pc	Kick	4611	Bd Distortion2	Dr/Pc	Kick	4691	Dub BD 5 St	Dr/Pc	Kick	4771	Sd Strong S3-4	Dr/Pc	Snare
4532	Bd GranCasaB 1-3 St	Dr/Pc	Kick	4612	Bd Distortion3	Dr/Pc	Kick	4692	Dub BD 6 St	Dr/Pc	Kick	4772	Sd Strong S1	Dr/Pc	Snare
4533	Bd GranCasaB 1-3 L	Dr/Pc	Kick	4613	Bd Distortion4	Dr/Pc	Kick	4693	Trap BD 1 Mn	Dr/Pc	Kick	4773	Sd Strong S2	Dr/Pc	Snare
4534	Bd GranCasaB 1-3 R	Dr/Pc	Kick	4614	Bd Distortion5	Dr/Pc	Kick	4694	Trap BD 2 Mn	Dr/Pc	Kick	4774	Sd Strong S3	Dr/Pc	Snare
4535	Bd GranCasaB 1 St	Dr/Pc	Kick	4615	Bd Distortion RM	Dr/Pc	Kick	4695	EDM BD 1 Mn	Dr/Pc	Kick	4775	Sd Strong S4	Dr/Pc	Snare
4536	Bd GranCasaB 1 L	Dr/Pc	Kick	4616	Bd +HH	Dr/Pc	Kick	4696	EDM BD 2 St	Dr/Pc	Kick	4776	Sd Strong L1-4	Dr/Pc	Snare
4537	Bd GranCasaB 1 R	Dr/Pc	Kick	4617	Artifact BD St	Dr/Pc	Kick	4697	EDM BD 3 Mn	Dr/Pc	Kick	4777	Sd Strong R1-4	Dr/Pc	Snare
4538	Bd GranCasaB 2 St	Dr/Pc	Kick	4618	Kindle BD St	Dr/Pc	Kick	4698	EDM BD 4 Mn	Dr/Pc	Kick	4778	Sd Strong L1	Dr/Pc	Snare
4539	Bd GranCasaB 2 L	Dr/Pc	Kick	4619	Bitling BD	Dr/Pc	Kick	4699	EDM BD 5 Mn	Dr/Pc	Kick	4779	Sd Strong L2	Dr/Pc	Snare
4540	Bd GranCasaB 2 R	Dr/Pc	Kick	4620	Fresh BD St	Dr/Pc	Kick	4700	House BD 1 St	Dr/Pc	Kick	4780	Sd Strong L3	Dr/Pc	Snare
4541	Bd GranCasaB 3 St	Dr/Pc	Kick	4621	Smith BD St	Dr/Pc	Kick	4701	House BD 2 St	Dr/Pc	Kick	4781	Sd Strong L4	Dr/Pc	Snare
4542	Bd GranCasaB 3 L	Dr/Pc	Kick	4622	Light BD	Dr/Pc	Kick	4702	House BD 3 St	Dr/Pc	Kick	4782	Sd Strong R1	Dr/Pc	Snare
4543	Bd GranCasaB 3 R	Dr/Pc	Kick	4623	Crackle BD St	Dr/Pc	Kick	4703	House BD 4 Mn	Dr/Pc	Kick	4783	Sd Strong R2	Dr/Pc	Snare
4544	Bd GranCasaB Hoop St	Dr/Pc	Kick	4624	Electric BD St	Dr/Pc	Kick	4704	Electro BD 1 Mn	Dr/Pc	Kick	4784	Sd Strong R3	Dr/Pc	Snare
4545	Bd GranCasaB Hoop L	Dr/Pc	Kick	4625	Clink BD St	Dr/Pc	Kick	4705	Electro BD 2 Mn	Dr/Pc	Kick	4785	Sd Strong R4	Dr/Pc	Snare
4546	Bd GranCasaB Hoop R	Dr/Pc	Kick	4626	Bd FxHammer	Dr/Pc	Kick	4706	Electro BD 3 Mn	Dr/Pc	Kick	4786	Sd Rng S1-4	Dr/Pc	Snare
4547	Bd GranCasaB MII St	Dr/Pc	Kick	4627	Bd ZapHard	Dr/Pc	Kick	4707	Electro BD 4 St	Dr/Pc	Kick	4787	Sd Rng S1-3	Dr/Pc	Snare
4548	Bd GranCasaB MII L	Dr/Pc	Kick	4628	Bd ZapMid	Dr/Pc	Kick	4708	Bd HipHop1	Dr/Pc	Kick	4788	Sd Rng S2-4	Dr/Pc	Snare
4549	Bd GranCasaB MII R	Dr/Pc	Kick	4629	Bd Sustain	Dr/Pc	Kick	4709	Bd HipHop2	Dr/Pc	Kick	4789	Sd Rng S1-2	Dr/Pc	Snare
4550	Bd Stk Kick	Dr/Pc	Kick	4630	Bd TekPower	Dr/Pc	Kick	4710	Bd HipHop3	Dr/Pc	Kick	4790	Sd Rng S2-3	Dr/Pc	Snare
4551	AT Kick Sw	Dr/Pc	Kick	4631	Bd Hard Long	Dr/Pc	Kick	4711	Bd HipHop4	Dr/Pc	Kick	4791	Sd Rng S3-4	Dr/Pc	Snare
4552	GT Kick1 Sw	Dr/Pc	Kick	4632	Bd Analog Tight	Dr/Pc	Kick	4712	Bd HipHop5	Dr/Pc	Kick	4792	Sd Rng S1	Dr/Pc	Snare
4553	GT Kick2 Sw	Dr/Pc	Kick	4633	Bd Analog Hard	Dr/Pc	Kick	4713	Bd HipHop6	Dr/Pc	Kick	4793	Sd Rng S2	Dr/Pc	Snare
4554	PL Kick1 Sw	Dr/Pc	Kick	4634	Bd Lo-Fi	Dr/Pc	Kick	4714	Bd HipHop7	Dr/Pc	Kick	4794	Sd Rng S3	Dr/Pc	Snare
4555	PL Kick2 Sw	Dr/Pc	Kick	4635	Bd ThickSkin	Dr/Pc	Kick	4715	Bd HipHop8	Dr/Pc	Kick	4795	Sd Rng S4	Dr/Pc	Snare
4556	Bd Gate	Dr/Pc	Kick	4636	Bd Slimy	Dr/Pc	Kick	4716	Bd HipHop9	Dr/Pc	Kick	4796	Sd Rng L1-4	Dr/Pc	Snare
4557	Bd FX Gate	Dr/Pc	Kick	4637	Bd Elec1	Dr/Pc	Kick	4717	Bd HipHop10	Dr/Pc	Kick	4797	Sd Rng R1-4	Dr/Pc	Snare
4558	Bd DanceGate1	Dr/Pc	Kick	4638	Bd Elec2	Dr/Pc	Kick	4718	Bd HipHop11	Dr/Pc	Kick	4798	Sd Rng L1	Dr/Pc	Snare
4559	Bd DanceGate2	Dr/Pc	Kick	4639	Bd Elec3	Dr/Pc	Kick	4719	Bd HipHop12	Dr/Pc	Kick	4799	Sd Rng L2	Dr/Pc	Snare
4560	Bd T9-1	Dr/Pc	Kick	4640	Bd Elec4	Dr/Pc	Kick	4720	Bd HipHop13	Dr/Pc	Kick	4800	Sd Rng L3	Dr/Pc	Snare

No.	Name	Main Category	Sub Category	No.	Name	Main Category	Sub Category	No.	Name	Main Category	Sub Category	No.	Name	Main Category	Sub Category
4801	Sd Ring L4	Dr/Pc	Snare	4881	Sd Blues S12-3	Dr/Pc	Snare	4961	Sd Piccolo Rim2	Dr/Pc	Snare	5041	Sd PowerD 2L	Dr/Pc	Snare
4802	Sd Ring R1	Dr/Pc	Snare	4882	Sd Blues S11/3	Dr/Pc	Snare	4962	Sd Mid	Dr/Pc	Snare	5042	Sd PowerD 2R	Dr/Pc	Snare
4803	Sd Ring R2	Dr/Pc	Snare	4883	Sd Blues S1S1	Dr/Pc	Snare	4963	Sd Mid Rim	Dr/Pc	Snare	5043	Sd PowerD 3S1	Dr/Pc	Snare
4804	Sd Ring R3	Dr/Pc	Snare	4884	Sd Blues 2St	Dr/Pc	Snare	4964	Sd Ambience	Dr/Pc	Snare	5044	Sd PowerD 3L	Dr/Pc	Snare
4805	Sd Ring R4	Dr/Pc	Snare	4885	Sd Blues 3S1	Dr/Pc	Snare	4965	Sd PowerA 1-5S1	Dr/Pc	Snare	5045	Sd PowerD 3R	Dr/Pc	Snare
4806	Sd Normal S11-4	Dr/Pc	Snare	4886	Sd Blues L1-3	Dr/Pc	Snare	4966	Sd PowerA 1-5L	Dr/Pc	Snare	5046	Sd PowerD 4S1	Dr/Pc	Snare
4807	Sd Normal S11-3	Dr/Pc	Snare	4887	Sd Blues R1-3	Dr/Pc	Snare	4967	Sd PowerA 1-5R	Dr/Pc	Snare	5047	Sd PowerD 4L	Dr/Pc	Snare
4808	Sd Normal S12-4	Dr/Pc	Snare	4888	Sd Blues 1L	Dr/Pc	Snare	4968	Sd PowerA 1-4S1	Dr/Pc	Snare	5048	Sd PowerD 4R	Dr/Pc	Snare
4809	Sd Normal S11-2	Dr/Pc	Snare	4889	Sd Blues 1R	Dr/Pc	Snare	4969	Sd PowerA 1-4L	Dr/Pc	Snare	5049	Sd PowerD 5S1	Dr/Pc	Snare
4810	Sd Normal S12-3	Dr/Pc	Snare	4890	Sd Blues 2L	Dr/Pc	Snare	4970	Sd PowerA 1-4R	Dr/Pc	Snare	5050	Sd PowerD 5L	Dr/Pc	Snare
4811	Sd Normal S13-4	Dr/Pc	Snare	4891	Sd Blues 2R	Dr/Pc	Snare	4971	Sd PowerA 1S1	Dr/Pc	Snare	5051	Sd PowerD 5R	Dr/Pc	Snare
4812	Sd Normal 1St	Dr/Pc	Snare	4892	Sd Blues 3L	Dr/Pc	Snare	4972	Sd PowerA 1L	Dr/Pc	Snare	5052	Sd Oak 1-4 St	Dr/Pc	Snare
4813	Sd Normal 2St	Dr/Pc	Snare	4893	Sd Blues 3R	Dr/Pc	Snare	4973	Sd PowerA 1R	Dr/Pc	Snare	5053	Sd Oak 1-4 L	Dr/Pc	Snare
4814	Sd Normal 3St	Dr/Pc	Snare	4894	Sd BluesHeart S11-3	Dr/Pc	Snare	4974	Sd PowerA 2S1	Dr/Pc	Snare	5054	Sd Oak 1-4 R	Dr/Pc	Snare
4815	Sd Normal 4St	Dr/Pc	Snare	4895	Sd BluesHeart S11-2	Dr/Pc	Snare	4975	Sd PowerA 2L	Dr/Pc	Snare	5055	Sd Oak 1-OpRm St	Dr/Pc	Snare
4816	Sd Normal L1-4	Dr/Pc	Snare	4896	Sd BluesHeart S12-3	Dr/Pc	Snare	4976	Sd PowerA 2R	Dr/Pc	Snare	5056	Sd Oak 1-OpRm L	Dr/Pc	Snare
4817	Sd Normal R1-4	Dr/Pc	Snare	4897	Sd BluesHeart S11/3	Dr/Pc	Snare	4977	Sd PowerA 3S1	Dr/Pc	Snare	5057	Sd Oak 1-OpRm R	Dr/Pc	Snare
4818	Sd Normal 1L	Dr/Pc	Snare	4898	Sd BluesHeart 1S1	Dr/Pc	Snare	4978	Sd PowerA 3L	Dr/Pc	Snare	5058	Sd Oak 1 St	Dr/Pc	Snare
4819	Sd Normal 1R	Dr/Pc	Snare	4899	Sd BluesHeart 2S1	Dr/Pc	Snare	4979	Sd PowerA 3R	Dr/Pc	Snare	5059	Sd Oak 1 L	Dr/Pc	Snare
4820	Sd Normal 2L	Dr/Pc	Snare	4900	Sd BluesHeart 3S1	Dr/Pc	Snare	4980	Sd PowerA 4S1	Dr/Pc	Snare	5060	Sd Oak 1 R	Dr/Pc	Snare
4821	Sd Normal 2R	Dr/Pc	Snare	4901	Sd BluesHeart L1-3	Dr/Pc	Snare	4981	Sd PowerA 4L	Dr/Pc	Snare	5061	Sd Oak 2 St	Dr/Pc	Snare
4822	Sd Normal 3L	Dr/Pc	Snare	4902	Sd BluesHeart R1-3	Dr/Pc	Snare	4982	Sd PowerA 4R	Dr/Pc	Snare	5062	Sd Oak 2 L	Dr/Pc	Snare
4823	Sd Normal 3R	Dr/Pc	Snare	4903	Sd BluesHeart 1L	Dr/Pc	Snare	4983	Sd PowerA 5S1	Dr/Pc	Snare	5063	Sd Oak 2 R	Dr/Pc	Snare
4824	Sd Normal 4L	Dr/Pc	Snare	4904	Sd BluesHeart 1R	Dr/Pc	Snare	4984	Sd PowerA 5L	Dr/Pc	Snare	5064	Sd Oak 3 St	Dr/Pc	Snare
4825	Sd Normal 4R	Dr/Pc	Snare	4905	Sd BluesHeart 2L	Dr/Pc	Snare	4985	Sd PowerA 5R	Dr/Pc	Snare	5065	Sd Oak 3 L	Dr/Pc	Snare
4826	Sd Funk S11-3	Dr/Pc	Snare	4906	Sd BluesHeart 2R	Dr/Pc	Snare	4986	Sd PowerB 1-5S1	Dr/Pc	Snare	5066	Sd Oak 3 R	Dr/Pc	Snare
4827	Sd Funk S11-2	Dr/Pc	Snare	4907	Sd BluesHeart 3L	Dr/Pc	Snare	4987	Sd PowerB 1-5L	Dr/Pc	Snare	5067	Sd Oak 4 St	Dr/Pc	Snare
4828	Sd Funk S12-3	Dr/Pc	Snare	4908	Sd BluesHeart 3R	Dr/Pc	Snare	4988	Sd PowerB 1-5R	Dr/Pc	Snare	5068	Sd Oak 4 L	Dr/Pc	Snare
4829	Sd Funk S11/3	Dr/Pc	Snare	4909	Sd Tight S11-4	Dr/Pc	Snare	4989	Sd PowerB 1-4S1	Dr/Pc	Snare	5069	Sd Oak 4 R	Dr/Pc	Snare
4830	Sd Funk 1S1	Dr/Pc	Snare	4910	Sd Tight S11-3	Dr/Pc	Snare	4990	Sd PowerB 1-4L	Dr/Pc	Snare	5070	Sd Oak OpRm 1-2 St	Dr/Pc	Snare
4831	Sd Funk 2St	Dr/Pc	Snare	4911	Sd Tight S12-4	Dr/Pc	Snare	4991	Sd PowerB 1-4R	Dr/Pc	Snare	5071	Sd Oak OpRm 1-2 L	Dr/Pc	Snare
4832	Sd Funk 3St	Dr/Pc	Snare	4912	Sd Tight S11-2	Dr/Pc	Snare	4992	Sd PowerB 1S1	Dr/Pc	Snare	5072	Sd Oak OpRm 1-2 R	Dr/Pc	Snare
4833	Sd Funk L1-3	Dr/Pc	Snare	4913	Sd Tight S12-3	Dr/Pc	Snare	4993	Sd PowerB 1L	Dr/Pc	Snare	5073	Sd Oak OpRm 1 St	Dr/Pc	Snare
4834	Sd Funk R1-3	Dr/Pc	Snare	4914	Sd Tight S13-4	Dr/Pc	Snare	4994	Sd PowerB 1R	Dr/Pc	Snare	5074	Sd Oak OpRm 1 L	Dr/Pc	Snare
4835	Sd Funk 1L	Dr/Pc	Snare	4915	Sd Tight 1St	Dr/Pc	Snare	4995	Sd PowerB 2S1	Dr/Pc	Snare	5075	Sd Oak OpRm 1 R	Dr/Pc	Snare
4836	Sd Funk 1R	Dr/Pc	Snare	4916	Sd Tight 2St	Dr/Pc	Snare	4996	Sd PowerB 2L	Dr/Pc	Snare	5076	Sd Oak OpRm 2 St	Dr/Pc	Snare
4837	Sd Funk 2L	Dr/Pc	Snare	4917	Sd Tight 3St	Dr/Pc	Snare	4997	Sd PowerB 2R	Dr/Pc	Snare	5077	Sd Oak OpRm 2 L	Dr/Pc	Snare
4838	Sd Funk 2R	Dr/Pc	Snare	4918	Sd Tight 4St	Dr/Pc	Snare	4998	Sd PowerB 3S1	Dr/Pc	Snare	5078	Sd Oak OpRm 2 R	Dr/Pc	Snare
4839	Sd Funk 3L	Dr/Pc	Snare	4919	Sd Tight L1-4	Dr/Pc	Snare	4999	Sd PowerB 3L	Dr/Pc	Snare	5079	Sd Oak ClRm St	Dr/Pc	Snare
4840	Sd Funk 3R	Dr/Pc	Snare	4920	Sd Tight R1-4	Dr/Pc	Snare	5000	Sd PowerB 3R	Dr/Pc	Snare	5080	Sd Oak ClRm L	Dr/Pc	Snare
4841	Sd Funk Ay St	Dr/Pc	Snare	4921	Sd Tight 1L	Dr/Pc	Snare	5001	Sd PowerB 4S1	Dr/Pc	Snare	5081	Sd Oak ClRm R	Dr/Pc	Snare
4842	Sd Funk Ay L	Dr/Pc	Snare	4922	Sd Tight 1R	Dr/Pc	Snare	5002	Sd PowerB 4L	Dr/Pc	Snare	5082	Sd Beech 1-4 St	Dr/Pc	Snare
4843	Sd Funk Ay R	Dr/Pc	Snare	4923	Sd Tight 2L	Dr/Pc	Snare	5003	Sd PowerB 4R	Dr/Pc	Snare	5083	Sd Beech 1-4 L	Dr/Pc	Snare
4844	Sd Basic S11-3	Dr/Pc	Snare	4924	Sd Tight 2R	Dr/Pc	Snare	5004	Sd PowerB 5S1	Dr/Pc	Snare	5084	Sd Beech 1-4 R	Dr/Pc	Snare
4845	Sd Basic S11-2	Dr/Pc	Snare	4925	Sd Tight 3L	Dr/Pc	Snare	5005	Sd PowerB 5L	Dr/Pc	Snare	5085	Sd Beech 1-OpRm St	Dr/Pc	Snare
4846	Sd Basic S12-3	Dr/Pc	Snare	4926	Sd Tight 3R	Dr/Pc	Snare	5006	Sd PowerB 5R	Dr/Pc	Snare	5086	Sd Beech 1-OpRm L	Dr/Pc	Snare
4847	Sd Basic S11/3	Dr/Pc	Snare	4927	Sd Tight 4L	Dr/Pc	Snare	5007	Sd PowerB 5S1	Dr/Pc	Snare	5087	Sd Beech 1-OpRm R	Dr/Pc	Snare
4848	Sd Basic 1St	Dr/Pc	Snare	4928	Sd Tight 4R	Dr/Pc	Snare	5008	Sd PowerB 5L	Dr/Pc	Snare	5088	Sd Beech 1 St	Dr/Pc	Snare
4849	Sd Basic 2St	Dr/Pc	Snare	4929	Sd Hip S11-2	Dr/Pc	Snare	5009	Sd PowerB SR	Dr/Pc	Snare	5089	Sd Beech 1 L	Dr/Pc	Snare
4850	Sd Basic 3St	Dr/Pc	Snare	4930	Sd Hip 1S1	Dr/Pc	Snare	5010	Sd PowerC 1-5S1	Dr/Pc	Snare	5090	Sd Beech 1 R	Dr/Pc	Snare
4851	Sd Basic L1-3	Dr/Pc	Snare	4931	Sd Hip 2S1	Dr/Pc	Snare	5011	Sd PowerC 1-5L	Dr/Pc	Snare	5091	Sd Beech 2 St	Dr/Pc	Snare
4852	Sd Basic R1-3	Dr/Pc	Snare	4932	Sd Hip L1-2	Dr/Pc	Snare	5012	Sd PowerC 1-5R	Dr/Pc	Snare	5092	Sd Beech 2 L	Dr/Pc	Snare
4853	Sd Basic 1L	Dr/Pc	Snare	4933	Sd Hip R1-2	Dr/Pc	Snare	5013	Sd PowerC 1-4S1	Dr/Pc	Snare	5093	Sd Beech 2 R	Dr/Pc	Snare
4854	Sd Basic 1R	Dr/Pc	Snare	4934	Sd Hip 1L	Dr/Pc	Snare	5014	Sd PowerC 1-4L	Dr/Pc	Snare	5094	Sd Beech 3 St	Dr/Pc	Snare
4855	Sd Basic 2L	Dr/Pc	Snare	4935	Sd Hip 1R	Dr/Pc	Snare	5015	Sd PowerC 1-4R	Dr/Pc	Snare	5095	Sd Beech 3 L	Dr/Pc	Snare
4856	Sd Basic 2R	Dr/Pc	Snare	4936	Sd Hip 2L	Dr/Pc	Snare	5016	Sd PowerC 1S1	Dr/Pc	Snare	5096	Sd Beech 3 R	Dr/Pc	Snare
4857	Sd Basic 3L	Dr/Pc	Snare	4937	Sd Hip 2R	Dr/Pc	Snare	5017	Sd PowerC 1L	Dr/Pc	Snare	5097	Sd Beech 4 St	Dr/Pc	Snare
4858	Sd Basic 3R	Dr/Pc	Snare	4938	Sd Rock Open1 St	Dr/Pc	Snare	5018	Sd PowerC 1R	Dr/Pc	Snare	5098	Sd Beech 4 L	Dr/Pc	Snare
4859	Sd SonA S11-4	Dr/Pc	Snare	4939	Sd Rock Open1 L	Dr/Pc	Snare	5019	Sd PowerC 2S1	Dr/Pc	Snare	5099	Sd Beech 4 R	Dr/Pc	Snare
4860	Sd SonA S11-3	Dr/Pc	Snare	4940	Sd Rock Open1 R	Dr/Pc	Snare	5020	Sd PowerC 2L	Dr/Pc	Snare	5100	Sd Beech OpRm 1-2 St	Dr/Pc	Snare
4861	Sd SonA S12-4	Dr/Pc	Snare	4941	Sd Rock Mute1 St	Dr/Pc	Snare	5021	Sd PowerC 2R	Dr/Pc	Snare	5101	Sd Beech OpRm 1-2 L	Dr/Pc	Snare
4862	Sd SonA S11-2	Dr/Pc	Snare	4942	Sd Rock Mute1 L	Dr/Pc	Snare	5022	Sd PowerC 3S1	Dr/Pc	Snare	5102	Sd Beech OpRm 1-2 R	Dr/Pc	Snare
4863	Sd SonA S12-3	Dr/Pc	Snare	4943	Sd Rock Mute1 R	Dr/Pc	Snare	5023	Sd PowerC 3L	Dr/Pc	Snare	5103	Sd Beech OpRm 1 St	Dr/Pc	Snare
4864	Sd SonA S13-4	Dr/Pc	Snare	4944	Sd Rock Rim1 St	Dr/Pc	Snare	5024	Sd PowerC 3R	Dr/Pc	Snare	5104	Sd Beech OpRm 1 L	Dr/Pc	Snare
4865	Sd SonA 1S1	Dr/Pc	Snare	4945	Sd Rock Rim1 L	Dr/Pc	Snare	5025	Sd PowerC 4S1	Dr/Pc	Snare	5105	Sd Beech OpRm 1 R	Dr/Pc	Snare
4866	Sd SonA 2St	Dr/Pc	Snare	4946	Sd Rock Rim1 R	Dr/Pc	Snare	5026	Sd PowerC 4L	Dr/Pc	Snare	5106	Sd Beech OpRm 2 St	Dr/Pc	Snare
4867	Sd SonA 3St	Dr/Pc	Snare	4947	Sd Rock Open2 St	Dr/Pc	Snare	5027	Sd PowerC 4R	Dr/Pc	Snare	5107	Sd Beech OpRm 2 L	Dr/Pc	Snare
4868	Sd SonA 4St	Dr/Pc	Snare	4948	Sd Rock Open2 L	Dr/Pc	Snare	5028	Sd PowerC 5S1	Dr/Pc	Snare	5108	Sd Beech OpRm 2 R	Dr/Pc	Snare
4869	Sd SonA L1-4	Dr/Pc	Snare	4949	Sd Rock Open2 R	Dr/Pc	Snare	5029	Sd PowerC 5L	Dr/Pc	Snare	5109	Sd Beech ClRm St	Dr/Pc	Snare
4870	Sd SonA R1-4	Dr/Pc	Snare	4950	Sd Rock Mute2 St	Dr/Pc	Snare	5030	Sd PowerC 5R	Dr/Pc	Snare	5110	Sd Beech ClRm L	Dr/Pc	Snare
4871	Sd SonA 1L	Dr/Pc	Snare	4951	Sd Rock Mute2 L	Dr/Pc	Snare	5031	Sd PowerD 1-5S1	Dr/Pc	Snare	5111	Sd Beech ClRm R	Dr/Pc	Snare
4872	Sd SonA 1R	Dr/Pc	Snare	4952	Sd Rock Mute2 R	Dr/Pc	Snare	5032	Sd PowerD 1-5L	Dr/Pc	Snare	5112	Sd Metal 1-4 St	Dr/Pc	Snare
4873	Sd SonA 2L	Dr/Pc	Snare	4953	Sd Rock Rim2 St	Dr/Pc	Snare	5033	Sd PowerD 1-5R	Dr/Pc	Snare	5113	Sd Metal 1-4 L	Dr/Pc	Snare
4874	Sd SonA 2R	Dr/Pc	Snare	4954	Sd Rock Rim2 L	Dr/Pc	Snare	5034	Sd PowerD 1-4S1	Dr/Pc	Snare	5114	Sd Metal 1-4 R	Dr/Pc	Snare
4875	Sd SonA 3L	Dr/Pc	Snare	4955	Sd Rock Rim2 R	Dr/Pc	Snare	5035	Sd PowerD 1-4L	Dr/Pc	Snare	5115	Sd Metal 1-OpRm St	Dr/Pc	Snare
4876	Sd SonA 3R	Dr/Pc	Snare	4956	Sd Rock Flam St	Dr/Pc	Snare	5036	Sd PowerD 1-4R	Dr/Pc	Snare	5116	Sd Metal 1-OpRm L	Dr/Pc	Snare
4877	Sd SonA 4L	Dr/Pc	Snare	4957	Sd Rock Flam L	Dr/Pc	Snare	5037	Sd PowerD 1S1	Dr/Pc	Snare	5117	Sd Metal 1-OpRm R	Dr/Pc	Snare
4878	Sd SonA 4R	Dr/Pc	Snare	4958	Sd Rock Flam R	Dr/Pc	Snare	5038	Sd PowerD 1L	Dr/Pc	Snare	5118	Sd Metal 1 St	Dr/Pc	Snare
4879	Sd Blues S11-3	Dr/Pc	Snare	4959	Sd Piccolo	Dr/Pc	Snare	5039	Sd PowerD 1R	Dr/Pc	Snare	5119	Sd Metal 1 L	Dr/Pc	Snare
4880	Sd Blues S11-2	Dr/Pc	Snare	4960	Sd Piccolo Rim1	Dr/Pc	Snare	5040	Sd PowerD 2S1	Dr/Pc	Snare	5120	Sd Metal 1 R	Dr/Pc	Snare

No.	Name	Main Category	Sub Category	No.	Name	Main Category	Sub Category	No.	Name	Main Category	Sub Category	No.	Name	Main Category	Sub Category
5121	Sd Metal 2 St	Dr/Pc	Snare	5201	Sd Closed Rim2	Dr/Pc	Snare	5281	Sd Orhc3 3 St	Dr/Pc	Snare	5361	T9 SD 2-3	Dr/Pc	Snare
5122	Sd Metal 2 L	Dr/Pc	Snare	5202	Sd Closed Rim3	Dr/Pc	Snare	5282	Sd Orhc3 3 L	Dr/Pc	Snare	5362	T9 SD 3-1	Dr/Pc	Snare
5123	Sd Metal 2 R	Dr/Pc	Snare	5203	Sd Closed Rim4	Dr/Pc	Snare	5283	Sd Orhc3 3 R	Dr/Pc	Snare	5363	T9 SD 3-2	Dr/Pc	Snare
5124	Sd Metal 3 St	Dr/Pc	Snare	5204	Sd Closed Rim5	Dr/Pc	Snare	5284	Sd Orhc3 4 St	Dr/Pc	Snare	5364	T9 SD 3-3	Dr/Pc	Snare
5125	Sd Metal 3 L	Dr/Pc	Snare	5205	Sd Closed Rim6	Dr/Pc	Snare	5285	Sd Orhc3 4 L	Dr/Pc	Snare	5365	T9 SD 4-1	Dr/Pc	Snare
5126	Sd Metal 3 R	Dr/Pc	Snare	5206	Sd RockRoll St	Dr/Pc	Snare	5286	Sd Orhc3 4 R	Dr/Pc	Snare	5366	T9 SD 4-2	Dr/Pc	Snare
5127	Sd Metal 4 St	Dr/Pc	Snare	5207	Sd RockRoll L	Dr/Pc	Snare	5287	Sd Orhc3 Roll St	Dr/Pc	Snare	5367	T9 SD 4-3	Dr/Pc	Snare
5128	Sd Metal 4 L	Dr/Pc	Snare	5208	Sd RockRoll R	Dr/Pc	Snare	5288	Sd Orhc3 Roll L	Dr/Pc	Snare	5368	T9 SD 5-1	Dr/Pc	Snare
5129	Sd Metal 4 R	Dr/Pc	Snare	5209	Sd RockRollID St	Dr/Pc	Snare	5289	Sd Orhc3 Roll R	Dr/Pc	Snare	5369	T9 SD 5-2	Dr/Pc	Snare
5130	Sd Metal OpRim 1-2 St	Dr/Pc	Snare	5210	Sd RockRollID L	Dr/Pc	Snare	5290	Sd Field 1-4 St	Dr/Pc	Snare	5370	T9 SD 5-3	Dr/Pc	Snare
5131	Sd Metal OpRim 1-2 L	Dr/Pc	Snare	5211	Sd RockRollID R	Dr/Pc	Snare	5291	Sd Field 1-4 L	Dr/Pc	Snare	5371	S&H T9 SD	Dr/Pc	Snare
5132	Sd Metal OpRim 1-2 R	Dr/Pc	Snare	5212	Sd LiveRoll St	Dr/Pc	Snare	5292	Sd Field 1-4 R	Dr/Pc	Snare	5372	Hard T9 SD	Dr/Pc	Snare
5133	Sd Metal OpRim 1 St	Dr/Pc	Snare	5213	Sd LiveRoll L	Dr/Pc	Snare	5293	Sd Field 1 St	Dr/Pc	Snare	5373	Elec T8 SD	Dr/Pc	Snare
5134	Sd Metal OpRim 1 L	Dr/Pc	Snare	5214	Sd LiveRoll R	Dr/Pc	Snare	5294	Sd Field 1 L	Dr/Pc	Snare	5374	T9 SD RimShot	Dr/Pc	Snare
5135	Sd Metal OpRim 1 R	Dr/Pc	Snare	5215	Sd Roll Mono	Dr/Pc	Snare	5295	Sd Field 1 R	Dr/Pc	Snare	5375	Elec T9 RimShot	Dr/Pc	Snare
5136	Sd Metal OpRim 2 St	Dr/Pc	Snare	5216	Sd Snare	Dr/Pc	Snare	5296	Sd Field 2 St	Dr/Pc	Snare	5376	Sd T8-1	Dr/Pc	Snare
5137	Sd Metal OpRim 2 L	Dr/Pc	Snare	5217	Sd Snare Tight	Dr/Pc	Snare	5297	Sd Field 2 L	Dr/Pc	Snare	5377	Sd T8-2	Dr/Pc	Snare
5138	Sd Metal OpRim 2 R	Dr/Pc	Snare	5218	Sd Open Rimshot	Dr/Pc	Snare	5298	Sd Field 2 R	Dr/Pc	Snare	5378	Sd T8-3	Dr/Pc	Snare
5139	Sd Metal ClRim L	Dr/Pc	Snare	5219	LW Snare Sw	Dr/Pc	Snare	5299	Sd Field 3 St	Dr/Pc	Snare	5379	Sd T8-4	Dr/Pc	Snare
5140	Sd Metal ClRim R	Dr/Pc	Snare	5220	DG Snare1 Sw	Dr/Pc	Snare	5300	Sd Field 3 L	Dr/Pc	Snare	5380	Sd T8-5	Dr/Pc	Snare
5141	Sd Metal SnRoll L	Dr/Pc	Snare	5221	DG Snare2 Sw	Dr/Pc	Snare	5301	Sd Field 3 R	Dr/Pc	Snare	5381	Sd T8 Rim	Dr/Pc	Snare
5142	Sd Metal SnRoll R	Dr/Pc	Snare	5222	TM Snare Sw	Dr/Pc	Snare	5302	Sd Field 4 St	Dr/Pc	Snare	5382	T8 SD Ac 1	Dr/Pc	Snare
5143	Sd Metal SnRoll L	Dr/Pc	Snare	5223	Bright Snare Roll	Dr/Pc	Snare	5303	Sd Field 4 L	Dr/Pc	Snare	5383	T8 SD Ac 2	Dr/Pc	Snare
5144	Sd Metal SnRoll R	Dr/Pc	Snare	5224	Sd Brush Soft St	Dr/Pc	Snare	5304	Sd Field 4 R	Dr/Pc	Snare	5384	T8 SD Ac 3	Dr/Pc	Snare
5145	Sd Njz 1-4 St	Dr/Pc	Snare	5225	Sd Brush Soft L	Dr/Pc	Snare	5305	Hiland Snare	Dr/Pc	Ethnc	5385	T8 SD NA 1	Dr/Pc	Snare
5146	Sd Njz 1-4 L	Dr/Pc	Snare	5226	Sd Brush Soft R	Dr/Pc	Snare	5306	Hiland Snare Rim	Dr/Pc	Ethnc	5386	T8 SD NA 2	Dr/Pc	Snare
5147	Sd Njz 1-4 R	Dr/Pc	Snare	5227	Sd Brush Med St	Dr/Pc	Snare	5307	Hiland Snare Open	Dr/Pc	Ethnc	5387	T8 SD NA 3	Dr/Pc	Snare
5148	Sd Njz 1-OpRim St	Dr/Pc	Snare	5228	Sd Brush Med L	Dr/Pc	Snare	5308	Hiland Snare Flam	Dr/Pc	Ethnc	5388	T8 RimShot	Dr/Pc	Snare
5149	Sd Njz 1-OpRim L	Dr/Pc	Snare	5229	Sd Brush Med R	Dr/Pc	Snare	5309	Hiland Snare ShtRil	Dr/Pc	Ethnc	5389	Sd RX11 A	Dr/Pc	Snare
5150	Sd Njz 1-OpRim R	Dr/Pc	Snare	5230	Sd Brush vari St	Dr/Pc	Snare	5310	Hiland Snare Slz	Dr/Pc	Ethnc	5390	Sd RX11 B	Dr/Pc	Snare
5151	Sd Njz 1 St	Dr/Pc	Snare	5231	Sd Brush vari L	Dr/Pc	Snare	5311	Hiland Snare Roll	Dr/Pc	Ethnc	5391	Sd AnSm	Dr/Pc	Snare
5152	Sd Njz 1 L	Dr/Pc	Snare	5232	Sd Brush vari R	Dr/Pc	Snare	5312	Caixa1 Center	Dr/Pc	Ethnc	5392	Sd AnSm Rim	Dr/Pc	Snare
5153	Sd Njz 1 R	Dr/Pc	Snare	5233	Sd Closed Rim4 St	Dr/Pc	Snare	5313	Caixa1 RimShot	Dr/Pc	Ethnc	5393	Sd AnCR	Dr/Pc	Snare
5154	Sd Njz 2 St	Dr/Pc	Snare	5234	Sd Closed Rim4 L	Dr/Pc	Snare	5314	Caixa2 Center	Dr/Pc	Ethnc	5394	Sd AnCR Rim	Dr/Pc	Snare
5155	Sd Njz 2 L	Dr/Pc	Snare	5235	Sd Closed Rim4 R	Dr/Pc	Snare	5315	Caixa2 RimShot	Dr/Pc	Ethnc	5395	Sd Human1	Dr/Pc	Snare
5156	Sd Njz 2 R	Dr/Pc	Snare	5236	Sd Brush Swir St	Dr/Pc	Snare	5316	Sd Elec1	Dr/Pc	Snare	5396	Sd Human2	Dr/Pc	Snare
5157	Sd Njz 3 St	Dr/Pc	Snare	5237	Sd Brush Swir L	Dr/Pc	Snare	5317	Sd Elec2	Dr/Pc	Snare	5397	Sd Jungle1	Dr/Pc	Snare
5158	Sd Njz 3 L	Dr/Pc	Snare	5238	Sd Brush Swir R	Dr/Pc	Snare	5318	Sd Elec3	Dr/Pc	Snare	5398	Sd Jungle2	Dr/Pc	Snare
5159	Sd Njz 3 R	Dr/Pc	Snare	5239	Sd Brush SwirAtt St	Dr/Pc	Snare	5319	Sd Elec4	Dr/Pc	Snare	5399	Sd Jungle3	Dr/Pc	Snare
5160	Sd Njz 4 St	Dr/Pc	Snare	5240	Sd Brush SwirAtt L	Dr/Pc	Snare	5320	Sd Elec5	Dr/Pc	Snare	5400	Sd JungleFX	Dr/Pc	Snare
5161	Sd Njz 4 L	Dr/Pc	Snare	5241	Sd Brush SwirAtt R	Dr/Pc	Snare	5321	Sd Elec6	Dr/Pc	Snare	5401	Sd D&B1	Dr/Pc	Snare
5162	Sd Njz 4 R	Dr/Pc	Snare	5242	Sd LW Brush Tap1 Sw	Dr/Pc	Snare	5322	Sd Elec7	Dr/Pc	Snare	5402	Sd D&B2	Dr/Pc	Snare
5163	Sd Njz OpRim 1-2 St	Dr/Pc	Snare	5243	Sd LW Brush Tap2 Sw	Dr/Pc	Snare	5323	Sd Elec8	Dr/Pc	Snare	5403	Sd D&B3	Dr/Pc	Snare
5164	Sd Njz OpRim 1-2 L	Dr/Pc	Snare	5244	Sd LW Brush Slap Sw	Dr/Pc	Snare	5324	Sd Elec9	Dr/Pc	Snare	5404	Sd D&B4	Dr/Pc	Snare
5165	Sd Njz OpRim 1-2 R	Dr/Pc	Snare	5245	Sd LW Brush Combi Sw	Dr/Pc	Snare	5325	Sd Elec10	Dr/Pc	Snare	5405	Sd R&B1	Dr/Pc	Snare
5166	Sd Njz OpRim 1 St	Dr/Pc	Snare	5246	Sd LW Brush Rim1 Sw	Dr/Pc	Snare	5326	Sd Elec11	Dr/Pc	Snare	5406	Sd R&B1 Rim	Dr/Pc	Snare
5167	Sd Njz OpRim 1 L	Dr/Pc	Snare	5247	Sd LW Brush Rim2 Sw	Dr/Pc	Snare	5327	Sd Elec12	Dr/Pc	Snare	5407	Sd R&B2	Dr/Pc	Snare
5168	Sd Njz OpRim 1 R	Dr/Pc	Snare	5248	Sd LW Brush Swir1	Dr/Pc	Snare	5328	Crisp Snare St	Dr/Pc	Snare	5408	Sd Hip1	Dr/Pc	Snare
5169	Sd Njz OpRim 2 St	Dr/Pc	Snare	5249	Sd LW Brush Swir2 Sw	Dr/Pc	Snare	5329	Digital Snare St	Dr/Pc	Snare	5409	Sd Hip2	Dr/Pc	Snare
5170	Sd Njz OpRim 2 L	Dr/Pc	Snare	5250	Sd LW Brush Swir3	Dr/Pc	Snare	5330	Elec Small Snare St	Dr/Pc	Snare	5410	Sd Hip3	Dr/Pc	Snare
5171	Sd Njz OpRim 2 R	Dr/Pc	Snare	5251	Sd LW Brush Swir4	Dr/Pc	Snare	5331	Echo Snare St	Dr/Pc	Snare	5411	Sd Hip Gate	Dr/Pc	Snare
5172	Sd Njz ClRim St	Dr/Pc	Snare	5252	Sd LW Brush Swir5	Dr/Pc	Snare	5332	Biting Snare 1	Dr/Pc	Snare	5412	Sd Hip Rim1	Dr/Pc	Snare
5173	Sd Njz ClRim L	Dr/Pc	Snare	5253	Sd LW Brush Swir6	Dr/Pc	Snare	5333	Biting Snare 2	Dr/Pc	Snare	5413	Sd Hip Rim2	Dr/Pc	Snare
5174	Sd Njz ClRim R	Dr/Pc	Snare	5254	Sd OrchA 1-2 St	Dr/Pc	Snare	5334	Fresh Snare 1	Dr/Pc	Snare	5414	Sd Hip Rim3	Dr/Pc	Snare
5175	Sd Gate1	Dr/Pc	Snare	5255	Sd OrchA 1 St	Dr/Pc	Snare	5335	Fresh Snare 2	Dr/Pc	Snare	5415	Sd Hip Rim4	Dr/Pc	Snare
5176	Sd Gate2	Dr/Pc	Snare	5256	Sd OrchA 2 St	Dr/Pc	Snare	5336	Shrill Snare St	Dr/Pc	Snare	5416	Sd Hip Rim5	Dr/Pc	Snare
5177	Sd LdWHMono	Dr/Pc	Snare	5257	Sd OrchA 1-2 L	Dr/Pc	Snare	5337	Strong Snare Wire	Dr/Pc	Snare	5417	Sd Break1	Dr/Pc	Snare
5178	Sd BreakRim	Dr/Pc	Snare	5258	Sd OrchA 1-2 R	Dr/Pc	Snare	5338	Elec Jazz Snare St	Dr/Pc	Snare	5418	Sd Break2	Dr/Pc	Snare
5179	Sd Dry	Dr/Pc	Snare	5259	Sd OrchA 1 L	Dr/Pc	Snare	5339	Elec Tight Snare St	Dr/Pc	Snare	5419	Sd Break3	Dr/Pc	Snare
5180	Sd Heavy	Dr/Pc	Snare	5260	Sd OrchA 2 L	Dr/Pc	Snare	5340	Electric Snare	Dr/Pc	Snare	5420	Sd Break Heavy	Dr/Pc	Snare
5181	Sd GM	Dr/Pc	Snare	5261	Sd OrchA 1 R	Dr/Pc	Snare	5341	Clang Snare St	Dr/Pc	Snare	5421	Sd Break Roll	Dr/Pc	Snare
5182	Sd Rock Stick1 St	Dr/Pc	Snare	5262	Sd OrchA 2 R	Dr/Pc	Snare	5342	Ambi Snare	Dr/Pc	Snare	5422	Sd FX1	Dr/Pc	Snare
5183	Sd Rock Stick1 L	Dr/Pc	Snare	5263	Sd OrchB 1-2 St	Dr/Pc	Snare	5343	Snare Roll OneShot	Dr/Pc	Snare	5423	Sd FX2	Dr/Pc	Snare
5184	Sd Rock Stick1 R	Dr/Pc	Snare	5264	Sd OrchB 1 St	Dr/Pc	Snare	5344	Fine Snare St	Dr/Pc	Snare	5424	Sd FX3	Dr/Pc	Snare
5185	Sd Rock Slic2 St	Dr/Pc	Snare	5265	Sd OrchB 2 St	Dr/Pc	Snare	5345	Elec Light Snare St	Dr/Pc	Snare	5425	Sd FX4	Dr/Pc	Snare
5186	Sd Rock Slic2 L	Dr/Pc	Snare	5266	Sd OrchB 1-2 L	Dr/Pc	Snare	5346	Crackle Snare St	Dr/Pc	Snare	5426	Sd Clap Analog	Dr/Pc	Snare
5187	Sd Rock Slic2 R	Dr/Pc	Snare	5267	Sd OrchB 1-2 R	Dr/Pc	Snare	5347	Sd HandClap	Dr/Pc	Snare	5427	Sd Dist	Dr/Pc	Snare
5188	Sd Hip Stick1	Dr/Pc	Snare	5268	Sd OrchB 1 L	Dr/Pc	Snare	5348	Sd Long Snare Wire	Dr/Pc	Snare	5428	Sd Cut	Dr/Pc	Snare
5189	Sd Hip Stick2	Dr/Pc	Snare	5269	Sd OrchB 2 L	Dr/Pc	Snare	5349	Sd T9-1	Dr/Pc	Snare	5429	Sd Garg H	Dr/Pc	Snare
5190	Sd Hip Stick3	Dr/Pc	Snare	5270	Sd OrchB 1 R	Dr/Pc	Snare	5350	Sd T9-2	Dr/Pc	Snare	5430	Sd Garg L	Dr/Pc	Snare
5191	Sd Hip Stick4	Dr/Pc	Snare	5271	Sd OrchB 2 R	Dr/Pc	Snare	5351	Sd T9-3	Dr/Pc	Snare	5431	Sd FM	Dr/Pc	Snare
5192	Sd Hip Stick5	Dr/Pc	Snare	5272	Sd Orhc 1-4 St	Dr/Pc	Snare	5352	Sd T9-4	Dr/Pc	Snare	5432	Sd FM Rim	Dr/Pc	Snare
5193	Sd Hip Stick6 St	Dr/Pc	Snare	5273	Sd Orhc 1-4 L	Dr/Pc	Snare	5353	Sd T9-5	Dr/Pc	Snare	5433	Sd Syn	Dr/Pc	Snare
5194	Sd Hip Stick6 L	Dr/Pc	Snare	5274	Sd Orhc 1-4 R	Dr/Pc	Snare	5354	Sd T9Gate	Dr/Pc	Snare	5434	Sd Clappy	Dr/Pc	Snare
5195	Sd Hip Stick6 R	Dr/Pc	Snare	5275	Sd Orhc 1 St	Dr/Pc	Snare	5355	Sd T9Rim	Dr/Pc	Snare	5435	Sd Timbr	Dr/Pc	Snare
5196	Sd Hip Stick7	Dr/Pc	Snare	5276	Sd Orhc 1 L	Dr/Pc	Snare	5356	T9 SD 1-1	Dr/Pc	Snare	5436	Sd Wood	Dr/Pc	Snare
5197	Sd Hip Stick8	Dr/Pc	Snare	5277	Sd Orhc 1 R	Dr/Pc	Snare	5357	T9 SD 1-2	Dr/Pc	Snare	5437	Sd Hammer	Dr/Pc	Snare
5198	Sd Closed Rim St	Dr/Pc	Snare	5278	Sd Orhc 2 St	Dr/Pc	Snare	5358	T9 SD 1-3	Dr/Pc	Snare	5438	Sd Lo-Fi	Dr/Pc	Snare
5199	Sd Closed Rim L	Dr/Pc	Snare	5279	Sd Orhc 2 L	Dr/Pc	Snare	5359	T9 SD 2-1	Dr/Pc	Snare	5439	Sd Rim SE	Dr/Pc	Snare
5200	Sd Closed Rim R	Dr/Pc	Snare	5280	Sd Orhc 2 R	Dr/Pc	Snare	5360	T9 SD 2-2	Dr/Pc	Snare	5440	Side Stick Analog	Dr/Pc	Snare

No.	Name	Main Category	Sub Category
5441	Snare Techno	Dr/Pc	Snare
5442	NeoSnare1	Dr/Pc	Snare
5443	NeoSnare2	Dr/Pc	Snare
5444	NeoSnare3	Dr/Pc	Snare
5445	Sd Clap1	Dr/Pc	Snare
5446	Sd Clap2	Dr/Pc	Snare
5447	Sd Clap3	Dr/Pc	Snare
5448	Sd LongGate	Dr/Pc	Snare
5449	Sd NineComp	Dr/Pc	Snare
5450	Sd ShortDry1	Dr/Pc	Snare
5451	Sd ShortDry2	Dr/Pc	Snare
5452	Sd ShortGate1	Dr/Pc	Snare
5453	Sd ShortGate2	Dr/Pc	Snare
5454	Sd ShortGate3	Dr/Pc	Snare
5455	Sd TB Gate	Dr/Pc	Snare
5456	Sd TB Q	Dr/Pc	Snare
5457	Sd TB Comp1	Dr/Pc	Snare
5458	Sd TB Comp2	Dr/Pc	Snare
5459	Dub SD 1 St	Dr/Pc	Snare
5460	Dub SD 2 St	Dr/Pc	Snare
5461	Dub SD 3 Mn	Dr/Pc	Snare
5462	Dub SD 4 Mn	Dr/Pc	Snare
5463	Dub SD 5 St	Dr/Pc	Snare
5464	Trap SD 1 St	Dr/Pc	Snare
5465	Trap SD 2 Mn	Dr/Pc	Snare
5466	Trap SD 3 Mn	Dr/Pc	Snare
5467	Trap SD 4 Mn	Dr/Pc	Snare
5468	Trap SD 5 St	Dr/Pc	Snare
5469	Trap SD 6 Mn	Dr/Pc	Snare
5470	EDM SD 1 St	Dr/Pc	Snare
5471	EDM SD 2 St	Dr/Pc	Snare
5472	EDM SD 3 St	Dr/Pc	Snare
5473	EDM SD 4 St	Dr/Pc	Snare
5474	EDM SD 5 St	Dr/Pc	Snare
5475	EDM SD 6 Mn	Dr/Pc	Snare
5476	House SD 1 St	Dr/Pc	Snare
5477	House SD 2 Mn	Dr/Pc	Snare
5478	House SD 3 St	Dr/Pc	Snare
5479	House SD 4 St	Dr/Pc	Snare
5480	House SD 5 St	Dr/Pc	Snare
5481	Electro SD 1 Mn	Dr/Pc	Snare
5482	Electro SD 2 Mn	Dr/Pc	Snare
5483	Electro SD 3 Mn	Dr/Pc	Snare
5484	Electro SD 4 Mn	Dr/Pc	Snare
5485	Electro SD 5 Mn	Dr/Pc	Snare
5486	Flam Mn	Dr/Pc	Snare
5487	Electro SD Sw	Dr/Pc	Snare
5488	Trap SD Sw	Dr/Pc	Snare
5489	Sd HipHop1	Dr/Pc	Snare
5490	Sd HipHop2	Dr/Pc	Snare
5491	Sd HipHop3	Dr/Pc	Snare
5492	Sd HipHop4	Dr/Pc	Snare
5493	Sd HipHop5	Dr/Pc	Snare
5494	Sd HipHop6	Dr/Pc	Snare
5495	Sd HipHop7	Dr/Pc	Snare
5496	Sd HipHop8	Dr/Pc	Snare
5497	Sd HipHop9	Dr/Pc	Snare
5498	Sd HipHop10	Dr/Pc	Snare
5499	Sd HipHop11	Dr/Pc	Snare
5500	Sd HipHop12	Dr/Pc	Snare
5501	Sd HipHop13	Dr/Pc	Snare
5502	Sd HipHop14	Dr/Pc	Snare
5503	Sd HipHop15	Dr/Pc	Snare
5504	Sd HipHop16	Dr/Pc	Snare
5505	Sd HipHop Rim1	Dr/Pc	Snare
5506	Sd HipHop Rim2	Dr/Pc	Snare
5507	Sd HipHop Rim3	Dr/Pc	Snare
5508	Sd HipHop Rim4	Dr/Pc	Snare
5509	Sd HipHop Rim5	Dr/Pc	Snare
5510	Sd HipHop Rim6	Dr/Pc	Snare
5511	HipHop SD 1 St	Dr/Pc	Snare
5512	HipHop SD 2 Mn	Dr/Pc	Snare
5513	HipHop SD 3 Mn	Dr/Pc	Snare
5514	HipHop Rim St	Dr/Pc	Snare
5515	HH Closed 1-4St	Dr/Pc	HHat
5516	HH Closed 1St	Dr/Pc	HHat
5517	HH Closed 2St	Dr/Pc	HHat
5518	HH Closed 3St	Dr/Pc	HHat
5519	HH Closed 4St	Dr/Pc	HHat
5520	HH Closed 1-4L	Dr/Pc	HHat

No.	Name	Main Category	Sub Category
5521	HH Closed 1-4R	Dr/Pc	HHat
5522	HH Closed 1L	Dr/Pc	HHat
5523	HH Closed 2L	Dr/Pc	HHat
5524	HH Closed 3L	Dr/Pc	HHat
5525	HH Closed 4L	Dr/Pc	HHat
5526	HH Closed 1R	Dr/Pc	HHat
5527	HH Closed 2R	Dr/Pc	HHat
5528	HH Closed 3R	Dr/Pc	HHat
5529	HH Closed 4R	Dr/Pc	HHat
5530	HH Closed 1-4RL	Dr/Pc	HHat
5531	HH Closed 1RL	Dr/Pc	HHat
5532	HH Closed 2RL	Dr/Pc	HHat
5533	HH Closed 3RL	Dr/Pc	HHat
5534	HH Closed 4RL	Dr/Pc	HHat
5535	HH Pedal 1-3St	Dr/Pc	HHat
5536	HH Pedal 1 St	Dr/Pc	HHat
5537	HH Pedal 2 St	Dr/Pc	HHat
5538	HH Pedal 3 St	Dr/Pc	HHat
5539	HH Pedal 1-3 L	Dr/Pc	HHat
5540	HH Pedal 1-3 R	Dr/Pc	HHat
5541	HH Pedal 1 L	Dr/Pc	HHat
5542	HH Pedal 2 L	Dr/Pc	HHat
5543	HH Pedal 3 L	Dr/Pc	HHat
5544	HH Pedal 1 R	Dr/Pc	HHat
5545	HH Pedal 2 R	Dr/Pc	HHat
5546	HH Pedal 3 R	Dr/Pc	HHat
5547	HH Pedal 1-3RL	Dr/Pc	HHat
5548	HH Pedal 1 RL	Dr/Pc	HHat
5549	HH Pedal 2 RL	Dr/Pc	HHat
5550	HH Pedal 3 RL	Dr/Pc	HHat
5551	HH Open 1-2St	Dr/Pc	HHat
5552	HH Open 1St	Dr/Pc	HHat
5553	HH Open 2St	Dr/Pc	HHat
5554	HH Open 1-2L	Dr/Pc	HHat
5555	HH Open 1-2R	Dr/Pc	HHat
5556	HH Open 1L	Dr/Pc	HHat
5557	HH Open 2L	Dr/Pc	HHat
5558	HH Open 1R	Dr/Pc	HHat
5559	HH Open 2R	Dr/Pc	HHat
5560	HH Open 1-2RL	Dr/Pc	HHat
5561	HH Open 1RL	Dr/Pc	HHat
5562	HH Open 2RL	Dr/Pc	HHat
5563	HH Closed Foot St	Dr/Pc	HHat
5564	HH Closed Foot L	Dr/Pc	HHat
5565	HH Closed Foot R	Dr/Pc	HHat
5566	HH Closed Foot RL	Dr/Pc	HHat
5567	HH Half Open2 St	Dr/Pc	HHat
5568	HH Half Open2 L	Dr/Pc	HHat
5569	HH Half Open2 R	Dr/Pc	HHat
5570	HH Half Open2 RL	Dr/Pc	HHat
5571	HH Open2 St	Dr/Pc	HHat
5572	HH Open2 L	Dr/Pc	HHat
5573	HH Open2 R	Dr/Pc	HHat
5574	HH Open2 RL	Dr/Pc	HHat
5575	HH Closed Rock Sw St	Dr/Pc	HHat
5576	HH Closed Rock S RL	Dr/Pc	HHat
5577	HH Closed Rock S St	Dr/Pc	HHat
5578	HH Closed Rock S RL	Dr/Pc	HHat
5579	HH Closed Rock H St	Dr/Pc	HHat
5580	HH Closed Rock H RL	Dr/Pc	HHat
5581	HH Closed Rock Sw L	Dr/Pc	HHat
5582	HH Closed Rock Sw R	Dr/Pc	HHat
5583	HH Closed Rock S L	Dr/Pc	HHat
5584	HH Closed Rock S R	Dr/Pc	HHat
5585	HH Closed Rock H L	Dr/Pc	HHat
5586	HH Closed Rock H R	Dr/Pc	HHat
5587	HH Pedal Rock Sw St	Dr/Pc	HHat
5588	HH Pedal Rock Sw RL	Dr/Pc	HHat
5589	HH Pedal Rock Sw L	Dr/Pc	HHat
5590	HH Pedal Rock Sw R	Dr/Pc	HHat
5591	HH Closed Rock 2St	Dr/Pc	HHat
5592	HH Closed Rock 2L	Dr/Pc	HHat
5593	HH Closed Rock 2R	Dr/Pc	HHat
5594	HH Closed Rock 2RL	Dr/Pc	HHat
5595	HH Pedal Rock St	Dr/Pc	HHat
5596	HH Pedal Rock L	Dr/Pc	HHat
5597	HH Pedal Rock R	Dr/Pc	HHat
5598	HH Pedal Rock RL	Dr/Pc	HHat
5599	HH Open Rock Sw St	Dr/Pc	HHat
5600	HH Open Rock Sw RL	Dr/Pc	HHat

No.	Name	Main Category	Sub Category
5601	HH Open Rock St	Dr/Pc	HHat
5602	HH Open Rock RL	Dr/Pc	HHat
5603	HH Half Open Rock St	Dr/Pc	HHat
5604	HH Open Rock Sw L	Dr/Pc	HHat
5605	HH Open Rock Sw R	Dr/Pc	HHat
5606	HH Open Rock L	Dr/Pc	HHat
5607	HH Open Rock R	Dr/Pc	HHat
5608	HH Half Open Rock L	Dr/Pc	HHat
5609	HH Half Open Rock R	Dr/Pc	HHat
5610	HH Half Open Rock RL	Dr/Pc	HHat
5611	HH Closed Mono	Dr/Pc	HHat
5612	HH Open Mono	Dr/Pc	HHat
5613	HH Pedal Mono	Dr/Pc	HHat
5614	HH Power CiTip 1-4St	Dr/Pc	HHat
5615	HH Power CiTip 1-4L	Dr/Pc	HHat
5616	HH Power CiTip 1-4R	Dr/Pc	HHat
5617	HH Power CiTip 1-4RL	Dr/Pc	HHat
5618	HH Power CiTip 1St	Dr/Pc	HHat
5619	HH Power CiTip 1L	Dr/Pc	HHat
5620	HH Power CiTip 1R	Dr/Pc	HHat
5621	HH Power CiTip 1RL	Dr/Pc	HHat
5622	HH Power CiTip 2St	Dr/Pc	HHat
5623	HH Power CiTip 2L	Dr/Pc	HHat
5624	HH Power CiTip 2R	Dr/Pc	HHat
5625	HH Power CiTip 2RL	Dr/Pc	HHat
5626	HH Power CiTip 3St	Dr/Pc	HHat
5627	HH Power CiTip 3L	Dr/Pc	HHat
5628	HH Power CiTip 3R	Dr/Pc	HHat
5629	HH Power CiTip 3RL	Dr/Pc	HHat
5630	HH Power CiTip 4St	Dr/Pc	HHat
5631	HH Power CiTip 4L	Dr/Pc	HHat
5632	HH Power CiTip 4R	Dr/Pc	HHat
5633	HH Power CiTip 4RL	Dr/Pc	HHat
5634	HH Power CiEdge1-4St	Dr/Pc	HHat
5635	HH Power CiEdge1-4L	Dr/Pc	HHat
5636	HH Power CiEdge1-4R	Dr/Pc	HHat
5637	HH Power CiEdge1-4RL	Dr/Pc	HHat
5638	HH Power CiEdge 1St	Dr/Pc	HHat
5639	HH Power CiEdge 1L	Dr/Pc	HHat
5640	HH Power CiEdge 1R	Dr/Pc	HHat
5641	HH Power CiEdge 1RL	Dr/Pc	HHat
5642	HH Power CiEdge 2St	Dr/Pc	HHat
5643	HH Power CiEdge 2L	Dr/Pc	HHat
5644	HH Power CiEdge 2R	Dr/Pc	HHat
5645	HH Power CiEdge 2RL	Dr/Pc	HHat
5646	HH Power CiEdge 3St	Dr/Pc	HHat
5647	HH Power CiEdge 3L	Dr/Pc	HHat
5648	HH Power CiEdge 3R	Dr/Pc	HHat
5649	HH Power CiEdge 3RL	Dr/Pc	HHat
5650	HH Power CiEdge 4St	Dr/Pc	HHat
5651	HH Power CiEdge 4L	Dr/Pc	HHat
5652	HH Power CiEdge 4R	Dr/Pc	HHat
5653	HH Power CiEdge 4RL	Dr/Pc	HHat
5654	HH Power CiPedal L	Dr/Pc	HHat
5655	HH Power CiPedal R	Dr/Pc	HHat
5656	HH Power CiPedal RL	Dr/Pc	HHat
5657	HH Power Open EdgeSt	Dr/Pc	HHat
5658	HH Power Open EdgeL	Dr/Pc	HHat
5659	HH Power Open EdgeR	Dr/Pc	HHat
5660	HH Power Open EdgeRL	Dr/Pc	HHat
5661	HH Dark Closed 1-4St	Dr/Pc	HHat
5662	HH Dark Closed 1-4St	Dr/Pc	HHat
5663	HH Dark Closed 1-4 L	Dr/Pc	HHat
5664	HH Dark Closed 1-4 R	Dr/Pc	HHat
5665	HH Dark Closed 1-4RL	Dr/Pc	HHat
5666	HH Dark Closed 1 St	Dr/Pc	HHat
5667	HH Dark Closed 1 L	Dr/Pc	HHat
5668	HH Dark Closed 1 R	Dr/Pc	HHat
5669	HH Dark Closed 1 RL	Dr/Pc	HHat
5670	HH Dark Closed 2 St	Dr/Pc	HHat
5671	HH Dark Closed 2 L	Dr/Pc	HHat
5672	HH Dark Closed 2 R	Dr/Pc	HHat
5673	HH Dark Closed 2 RL	Dr/Pc	HHat
5674	HH Dark Closed 3 St	Dr/Pc	HHat
5675	HH Dark Closed 3 L	Dr/Pc	HHat
5676	HH Dark Closed 3 R	Dr/Pc	HHat
5677	HH Dark Closed 3 RL	Dr/Pc	HHat
5678	HH Dark Closed 4 St	Dr/Pc	HHat
5679	HH Dark Closed 4 L	Dr/Pc	HHat
5680	HH Dark Closed 4 R	Dr/Pc	HHat

No.	Name	Main Category	Sub Category
5681	HH Dark Closed 4 RL	Dr/Pc	HHat
5682	HH Dark Pedal 1-2 St	Dr/Pc	HHat
5683	HH Dark Pedal 1-2 L	Dr/Pc	HHat
5684	HH Dark Pedal 1-2 R	Dr/Pc	HHat
5685	HH Dark Pedal 1-2 RL	Dr/Pc	HHat
5686	HH Dark Pedal 1 St	Dr/Pc	HHat
5687	HH Dark Pedal 1 L	Dr/Pc	HHat
5688	HH Dark Pedal 1 R	Dr/Pc	HHat
5689	HH Dark Pedal 1 RL	Dr/Pc	HHat
5690	HH Dark Pedal 2 St	Dr/Pc	HHat
5691	HH Dark Pedal 2 L	Dr/Pc	HHat
5692	HH Dark Pedal 2 R	Dr/Pc	HHat
5693	HH Dark Pedal 2 RL	Dr/Pc	HHat
5694	HH Dark Open 1-2 St	Dr/Pc	HHat
5695	HH Dark Open 1-2 L	Dr/Pc	HHat
5696	HH Dark Open 1-2 R	Dr/Pc	HHat
5697	HH Dark Open 1-2 RL	Dr/Pc	HHat
5698	HH Dark Open 1 St	Dr/Pc	HHat
5699	HH Dark Open 1 L	Dr/Pc	HHat
5700	HH Dark Open 1 R	Dr/Pc	HHat
5701	HH Dark Open 1 RL	Dr/Pc	HHat
5702	HH Dark Open 2 St	Dr/Pc	HHat
5703	HH Dark Open 2 L	Dr/Pc	HHat
5704	HH Dark Open 2 R	Dr/Pc	HHat
5705	HH Dark Open 2 RL	Dr/Pc	HHat
5706	HH Njz Closed 1-4 St	Dr/Pc	HHat
5707	HH Njz Closed 1-4 L	Dr/Pc	HHat
5708	HH Njz Closed 1-4 R	Dr/Pc	HHat
5709	HH Njz Closed 1-4 RL	Dr/Pc	HHat
5710	HH Njz Closed 1 St	Dr/Pc	HHat
5711	HH Njz Closed 1 L	Dr/Pc	HHat
5712	HH Njz Closed 1 R	Dr/Pc	HHat
5713	HH Njz Closed 1 RL	Dr/Pc	HHat
5714	HH Njz Closed 2 St	Dr/Pc	HHat
5715	HH Njz Closed 2 L	Dr/Pc	HHat
5716	HH Njz Closed 2 R	Dr/Pc	HHat
5717	HH Njz Closed 2 RL	Dr/Pc	HHat
5718	HH Njz Closed 3 St	Dr/Pc	HHat
5719	HH Njz Closed 3 L	Dr/Pc	HHat
5720	HH Njz Closed 3 R	Dr/Pc	HHat
5721	HH Njz Closed 3 RL	Dr/Pc	HHat
5722	HH Njz Closed 4 St	Dr/Pc	HHat
5723	HH Njz Closed 4 L	Dr/Pc	HHat
5724	HH Njz Closed 4 R	Dr/Pc	HHat
5725	HH Njz Closed 4 RL	Dr/Pc	HHat
5726	HH Njz Pedal 1-2 St	Dr/Pc	HHat
5727	HH Njz Pedal 1-2 L	Dr/Pc	HHat
5728	HH Njz Pedal 1-2 R	Dr/Pc	HHat
5729	HH Njz Pedal 1-2 RL	Dr/Pc	HHat
5730	HH Njz Pedal 1 St	Dr/Pc	HHat
5731	HH Njz Pedal 1 L	Dr/Pc	HHat
5732	HH Njz Pedal 1 R	Dr/Pc	HHat
5733	HH Njz Pedal 1 RL	Dr/Pc	HHat
5734	HH Njz Pedal 2 St	Dr/Pc	HHat
5735	HH Njz Pedal 2 L	Dr/Pc	HHat
5736	HH Njz Pedal 2 R	Dr/Pc	HHat
5737	HH Njz Pedal 2 RL	Dr/Pc	HHat
5738	HH Njz Open 1-2 St	Dr/Pc	HHat
5739	HH Njz Open 1-2 L	Dr/Pc	HHat
5740	HH Njz Open 1-2 R		

No.	Name	Main Category	Sub Category	No.	Name	Main Category	Sub Category	No.	Name	Main Category	Sub Category	No.	Name	Main Category	Sub Category
5761	HH Brush Open	Dr/Pc	HHat	5841	HipHop HH 1 Mn	Dr/Pc	HHat	5921	Tom Power02 1R	Dr/Pc	Tom	6001	Tom Oak Mid 1-2 R	Dr/Pc	Tom
5762	HH Brush Pedal	Dr/Pc	HHat	5842	HipHop HH 2 Mn	Dr/Pc	HHat	5922	Tom Power02 1RL	Dr/Pc	Tom	6002	Tom Oak Mid 1-2 RL	Dr/Pc	Tom
5763	HH IB Brush Cls	Dr/Pc	HHat	5843	EDM HH 1 St	Dr/Pc	HHat	5923	Tom Power02 2St	Dr/Pc	Tom	6003	Tom Oak Mid 1 St	Dr/Pc	Tom
5764	HH IB Brush Opn	Dr/Pc	HHat	5844	EDM HH 2 Mn	Dr/Pc	HHat	5924	Tom Power02 2L	Dr/Pc	Tom	6004	Tom Oak Mid 1 L	Dr/Pc	Tom
5765	HH IB Brush Pdl	Dr/Pc	HHat	5845	EDM HH 3 Mn	Dr/Pc	HHat	5925	Tom Power02 2R	Dr/Pc	Tom	6005	Tom Oak Mid 1 R	Dr/Pc	Tom
5766	HH Closed T9	Dr/Pc	HHat	5846	EDM HH 4 St	Dr/Pc	HHat	5926	Tom Power02 2RL	Dr/Pc	Tom	6006	Tom Oak Mid 1 RL	Dr/Pc	Tom
5767	HH Open T9	Dr/Pc	HHat	5847	EDM HH 5 St	Dr/Pc	HHat	5927	Tom Power03 1-2St	Dr/Pc	Tom	6007	Tom Oak Mid 2 St	Dr/Pc	Tom
5768	T9 HHCl 1	Dr/Pc	HHat	5848	EDM OHH 1 Mn	Dr/Pc	HHat	5928	Tom Power03 1-2L	Dr/Pc	Tom	6008	Tom Oak Mid 2 L	Dr/Pc	Tom
5769	T9 HHCl 2	Dr/Pc	HHat	5849	EDM OHH 2 St	Dr/Pc	HHat	5929	Tom Power03 1-2R	Dr/Pc	Tom	6009	Tom Oak Mid 2 R	Dr/Pc	Tom
5770	T9 HHCl 3	Dr/Pc	HHat	5850	EDM OHH 3 St	Dr/Pc	HHat	5930	Tom Power03 1-2RL	Dr/Pc	Tom	6010	Tom Oak Mid 2 RL	Dr/Pc	Tom
5771	T9 HHCl 4	Dr/Pc	HHat	5851	EDM OHH 4 St	Dr/Pc	HHat	5931	Tom Power03 1St	Dr/Pc	Tom	6011	Tom Oak Floor 1-2 St	Dr/Pc	Tom
5772	T9 HHCl 5	Dr/Pc	HHat	5852	House HH 1 St	Dr/Pc	HHat	5932	Tom Power03 1L	Dr/Pc	Tom	6012	Tom Oak Floor 1-2 L	Dr/Pc	Tom
5773	T9 HHOp 1	Dr/Pc	HHat	5853	House HH 2 Mn	Dr/Pc	HHat	5933	Tom Power03 1R	Dr/Pc	Tom	6013	Tom Oak Floor 1-2 R	Dr/Pc	Tom
5774	T9 HHOp 2	Dr/Pc	HHat	5854	House HH 3 Mn	Dr/Pc	HHat	5934	Tom Power03 1RL	Dr/Pc	Tom	6014	Tom Oak Floor 1-2 RL	Dr/Pc	Tom
5775	T9 HHOp 3	Dr/Pc	HHat	5855	House OHH 1 St	Dr/Pc	HHat	5935	Tom Power03 2St	Dr/Pc	Tom	6015	Tom Oak Floor 1 St	Dr/Pc	Tom
5776	T9 HHOp 4	Dr/Pc	HHat	5856	House OHH 2 St	Dr/Pc	HHat	5936	Tom Power03 2L	Dr/Pc	Tom	6016	Tom Oak Floor 1 L	Dr/Pc	Tom
5777	T9 HHOp 5	Dr/Pc	HHat	5857	Electro HH 1 St	Dr/Pc	HHat	5937	Tom Power03 2R	Dr/Pc	Tom	6017	Tom Oak Floor 1 R	Dr/Pc	Tom
5778	Hard T9 HHCl	Dr/Pc	HHat	5858	Electro HH 2 St	Dr/Pc	HHat	5938	Tom Power03 2RL	Dr/Pc	Tom	6018	Tom Oak Floor 1 RL	Dr/Pc	Tom
5779	Elec T9 HHOp	Dr/Pc	HHat	5859	Electro HH 3 St	Dr/Pc	HHat	5939	Tom Power04 1-2St	Dr/Pc	Tom	6019	Tom Oak Floor 2 St	Dr/Pc	Tom
5780	HH Closed T8-1	Dr/Pc	HHat	5860	Electro HH 4 St	Dr/Pc	HHat	5940	Tom Power04 1-2L	Dr/Pc	Tom	6020	Tom Oak Floor 2 L	Dr/Pc	Tom
5781	HH Open T8-1	Dr/Pc	HHat	5861	Electro OHH 1 St	Dr/Pc	HHat	5941	Tom Power04 1-2R	Dr/Pc	Tom	6021	Tom Oak Floor 2 R	Dr/Pc	Tom
5782	HH Closed T8-2	Dr/Pc	HHat	5862	Electro OHH 2 St	Dr/Pc	HHat	5942	Tom Power04 1-2RL	Dr/Pc	Tom	6022	Tom Oak Floor 2 RL	Dr/Pc	Tom
5783	HH Open T8-2	Dr/Pc	HHat	5863	Electro OHH 3 Mn	Dr/Pc	HHat	5943	Tom Power04 1St	Dr/Pc	Tom	6023	Tom Njz Mid 1-2 St	Dr/Pc	Tom
5784	T8 HHCl	Dr/Pc	HHat	5864	Open HH Oneshot	Dr/Pc	HHat	5944	Tom Power04 1L	Dr/Pc	Tom	6024	Tom Njz Mid 1-2 L	Dr/Pc	Tom
5785	T8 HHClp	Dr/Pc	HHat	5865	Oph HH 14inch	Dr/Pc	HHat	5945	Tom Power04 1R	Dr/Pc	Tom	6025	Tom Njz Mid 1-2 R	Dr/Pc	Tom
5786	T8 HHOp 1	Dr/Pc	HHat	5866	Trap HH Sw	Dr/Pc	HHat	5946	Tom Power04 1RL	Dr/Pc	Tom	6026	Tom Njz Mid 1-2 RL	Dr/Pc	Tom
5787	T8 HHOp 2	Dr/Pc	HHat	5867	Tight HH Closed	Dr/Pc	HHat	5947	Tom Power04 2St	Dr/Pc	Tom	6027	Tom Njz Mid 1 St	Dr/Pc	Tom
5788	T8 HHOp 3	Dr/Pc	HHat	5868	Fresh HH Closed	Dr/Pc	HHat	5948	Tom Power04 2L	Dr/Pc	Tom	6028	Tom Njz Mid 1 L	Dr/Pc	Tom
5789	T8 HHOp 4	Dr/Pc	HHat	5869	Elec HH 1 Closed	Dr/Pc	HHat	5949	Tom Power04 2R	Dr/Pc	Tom	6029	Tom Njz Mid 1 R	Dr/Pc	Tom
5790	S&H T8 HHCl	Dr/Pc	HHat	5870	Elec HH 1 Open	Dr/Pc	HHat	5950	Tom Power04 2RL	Dr/Pc	Tom	6030	Tom Njz Mid 1 RL	Dr/Pc	Tom
5791	S&H T8 HHOp 1	Dr/Pc	HHat	5871	Elec HH 2 Closed	Dr/Pc	HHat	5951	Tom Maple Hi 1-2 St	Dr/Pc	Tom	6031	Tom Njz Mid 2 St	Dr/Pc	Tom
5792	S&H T8 HHOp 2	Dr/Pc	HHat	5872	Powerful HH Closed	Dr/Pc	HHat	5952	Tom Maple Hi 1-2 L	Dr/Pc	Tom	6032	Tom Njz Mid 2 L	Dr/Pc	Tom
5793	Elec T8 HHCl	Dr/Pc	HHat	5873	Powerful HH Open	Dr/Pc	HHat	5953	Tom Maple Hi 1-2 R	Dr/Pc	Tom	6033	Tom Njz Mid 2 R	Dr/Pc	Tom
5794	HH Closed RX5	Dr/Pc	HHat	5874	Crackle HH Open	Dr/Pc	HHat	5954	Tom Maple Hi 1-2 RL	Dr/Pc	Tom	6034	Tom Njz Mid 2 RL	Dr/Pc	Tom
5795	HH Closed RX11	Dr/Pc	HHat	5875	Tom Hi St	Dr/Pc	Tom	5955	Tom Maple Hi 1 St	Dr/Pc	Tom	6035	Tom Njz Low 1-2 St	Dr/Pc	Tom
5796	HH Open RX11	Dr/Pc	HHat	5876	Tom Hi L	Dr/Pc	Tom	5956	Tom Maple Hi 1 L	Dr/Pc	Tom	6036	Tom Njz Low 1-2 L	Dr/Pc	Tom
5797	HH Closed AnCR	Dr/Pc	HHat	5877	Tom Hi R	Dr/Pc	Tom	5957	Tom Maple Hi 1 R	Dr/Pc	Tom	6037	Tom Njz Low 1-2 R	Dr/Pc	Tom
5798	HH Open AnCR	Dr/Pc	HHat	5878	Tom Hi RL	Dr/Pc	Tom	5958	Tom Maple Hi 1 RL	Dr/Pc	Tom	6038	Tom Njz Low 1-2 RL	Dr/Pc	Tom
5799	HH Closed Break	Dr/Pc	HHat	5879	Tom Mid St	Dr/Pc	Tom	5959	Tom Maple Hi 2 St	Dr/Pc	Tom	6039	Tom Njz Low 1 St	Dr/Pc	Tom
5800	HH Pedal Break	Dr/Pc	HHat	5880	Tom Mid L	Dr/Pc	Tom	5960	Tom Maple Hi 2 L	Dr/Pc	Tom	6040	Tom Njz Low 1 L	Dr/Pc	Tom
5801	HH Closed D&B	Dr/Pc	HHat	5881	Tom Mid R	Dr/Pc	Tom	5961	Tom Maple Hi 2 R	Dr/Pc	Tom	6041	Tom Njz Low 1 R	Dr/Pc	Tom
5802	HH Pedal D&B	Dr/Pc	HHat	5882	Tom Mid RL	Dr/Pc	Tom	5962	Tom Maple Hi 2 RL	Dr/Pc	Tom	6042	Tom Njz Low 1 RL	Dr/Pc	Tom
5803	HH Open D&B	Dr/Pc	HHat	5883	Tom Low St	Dr/Pc	Tom	5963	Tom Maple Mid 1-2 St	Dr/Pc	Tom	6043	Tom Njz Low 2 St	Dr/Pc	Tom
5804	HH Reverse D&B	Dr/Pc	HHat	5884	Tom Low L	Dr/Pc	Tom	5964	Tom Maple Mid 1-2 L	Dr/Pc	Tom	6044	Tom Njz Low 2 L	Dr/Pc	Tom
5805	HH Closed Tek	Dr/Pc	HHat	5885	Tom Low R	Dr/Pc	Tom	5965	Tom Maple Mid 1-2 R	Dr/Pc	Tom	6045	Tom Njz Low 2 R	Dr/Pc	Tom
5806	HH Open Tek	Dr/Pc	HHat	5886	Tom Low RL	Dr/Pc	Tom	5966	Tom Maple Mid 1-2 RL	Dr/Pc	Tom	6046	Tom Njz Low 2 RL	Dr/Pc	Tom
5807	HH Closed Hip	Dr/Pc	HHat	5887	Tom Floor St	Dr/Pc	Tom	5967	Tom Maple Mid 1 St	Dr/Pc	Tom	6047	Tom Njz Floor 1-2 St	Dr/Pc	Tom
5808	HH Pedal Hip	Dr/Pc	HHat	5888	Tom Floor L	Dr/Pc	Tom	5968	Tom Maple Mid 1 L	Dr/Pc	Tom	6048	Tom Njz Floor 1-2 L	Dr/Pc	Tom
5809	HH Open Hip	Dr/Pc	HHat	5889	Tom Floor R	Dr/Pc	Tom	5969	Tom Maple Mid 1 R	Dr/Pc	Tom	6049	Tom Njz Floor 1-2 R	Dr/Pc	Tom
5810	HH Closed Lo-Fi	Dr/Pc	HHat	5890	Tom Floor RL	Dr/Pc	Tom	5970	Tom Maple Mid 1 RL	Dr/Pc	Tom	6050	Tom Njz Floor 1-2 RL	Dr/Pc	Tom
5811	HH Open Lo-Fi	Dr/Pc	HHat	5891	Tom Rock Hi St	Dr/Pc	Tom	5971	Tom Maple Mid 2 St	Dr/Pc	Tom	6051	Tom Njz Floor 1 St	Dr/Pc	Tom
5812	HH Closed Syn	Dr/Pc	HHat	5892	Tom Rock Hi L	Dr/Pc	Tom	5972	Tom Maple Mid 2 L	Dr/Pc	Tom	6052	Tom Njz Floor 1 L	Dr/Pc	Tom
5813	HH Open Syn	Dr/Pc	HHat	5893	Tom Rock Hi R	Dr/Pc	Tom	5973	Tom Maple Mid 2 R	Dr/Pc	Tom	6053	Tom Njz Floor 1 R	Dr/Pc	Tom
5814	HH Closed FX	Dr/Pc	HHat	5894	Tom Rock Hi RL	Dr/Pc	Tom	5974	Tom Maple Mid 2 RL	Dr/Pc	Tom	6054	Tom Njz Floor 1 RL	Dr/Pc	Tom
5815	HH Open FX	Dr/Pc	HHat	5895	Tom Rock Mid St	Dr/Pc	Tom	5975	Tom Maple Fir 1-2 St	Dr/Pc	Tom	6055	Tom Njz Floor 2 St	Dr/Pc	Tom
5816	HH Open Human	Dr/Pc	HHat	5896	Tom Rock Mid L	Dr/Pc	Tom	5976	Tom Maple Fir 1-2 L	Dr/Pc	Tom	6056	Tom Njz Floor 2 L	Dr/Pc	Tom
5817	HH ClosedNine	Dr/Pc	HHat	5897	Tom Rock Mid R	Dr/Pc	Tom	5977	Tom Maple Fir 1-2 R	Dr/Pc	Tom	6057	Tom Njz Floor 2 R	Dr/Pc	Tom
5818	HH PedalNine	Dr/Pc	HHat	5898	Tom Rock Mid RL	Dr/Pc	Tom	5978	Tom Maple Fir 1-2 RL	Dr/Pc	Tom	6058	CP Tom High Sw	Dr/Pc	Tom
5819	HH OpenNine	Dr/Pc	HHat	5899	Tom Rock Low St	Dr/Pc	Tom	5979	Tom Maple Fir 1 St	Dr/Pc	Tom	6059	Std Tom High	Dr/Pc	Tom
5820	HH TecClosed1	Dr/Pc	HHat	5900	Tom Rock Low L	Dr/Pc	Tom	5980	Tom Maple Fir 1 L	Dr/Pc	Tom	6060	Std Tom Mid	Dr/Pc	Tom
5821	HH TecOpen1	Dr/Pc	HHat	5901	Tom Rock Low R	Dr/Pc	Tom	5981	Tom Maple Fir 1 R	Dr/Pc	Tom	6061	Std Tom Low H	Dr/Pc	Tom
5822	HH TecClosed2	Dr/Pc	HHat	5902	Tom Rock Low RL	Dr/Pc	Tom	5982	Tom Maple Fir 1 RL	Dr/Pc	Tom	6062	Std Tom Low L	Dr/Pc	Tom
5823	HH TecOpen2	Dr/Pc	HHat	5903	Tom Power01 1-2St	Dr/Pc	Tom	5983	Tom Maple Fir 2 St	Dr/Pc	Tom	6063	Std Tom Floor H	Dr/Pc	Tom
5824	Dub HH 1 Mn	Dr/Pc	HHat	5904	Tom Power01 1-2L	Dr/Pc	Tom	5984	Tom Maple Fir 2 L	Dr/Pc	Tom	6064	Std Tom Floor M	Dr/Pc	Tom
5825	Dub HH 2 Mn	Dr/Pc	HHat	5905	Tom Power01 1-2R	Dr/Pc	Tom	5985	Tom Maple Fir 2 R	Dr/Pc	Tom	6065	Std Tom Floor L	Dr/Pc	Tom
5826	Dub OHH 1 St	Dr/Pc	HHat	5906	Tom Power01 1-2RL	Dr/Pc	Tom	5986	Tom Maple Fir 2 RL	Dr/Pc	Tom	6066	CP Tom High Sw	Dr/Pc	Tom
5827	Dub OHH 2 Mn	Dr/Pc	HHat	5907	Tom Power01 1St	Dr/Pc	Tom	5987	Tom Oak Hi 1-2 St	Dr/Pc	Tom	6067	CP Tom Mid Sw	Dr/Pc	Tom
5828	Trap HH 1 St	Dr/Pc	HHat	5908	Tom Power01 1L	Dr/Pc	Tom	5988	Tom Oak Hi 1-2 L	Dr/Pc	Tom	6068	CP Tom Low Sw	Dr/Pc	Tom
5829	Trap HH 2 St	Dr/Pc	HHat	5909	Tom Power01 1R	Dr/Pc	Tom	5989	Tom Oak Hi 1-2 R	Dr/Pc	Tom	6069	CP Tom Floor Sw	Dr/Pc	Tom
5830	Trap HH 3 St	Dr/Pc	HHat	5910	Tom Power01 1RL	Dr/Pc	Tom	5990	Tom Oak Hi 1-2 RL	Dr/Pc	Tom	6070	Tom Brush Hi St	Dr/Pc	Tom
5831	Trap HH 4 St	Dr/Pc	HHat	5911	Tom Power01 2St	Dr/Pc	Tom	5991	Tom Oak Hi 1 St	Dr/Pc	Tom	6071	Tom Brush Hi L	Dr/Pc	Tom
5832	Trap HH 5 St	Dr/Pc	HHat	5912	Tom Power01 2L	Dr/Pc	Tom	5992	Tom Oak Hi 1 L	Dr/Pc	Tom	6072	Tom Brush Hi R	Dr/Pc	Tom
5833	Trap HH 6 St	Dr/Pc	HHat	5913	Tom Power01 2R	Dr/Pc	Tom	5993	Tom Oak Hi 1 R	Dr/Pc	Tom	6073	Tom Brush Hi RL	Dr/Pc	Tom
5834	Trap HH 7 St	Dr/Pc	HHat	5914	Tom Power01 2RL	Dr/Pc	Tom	5994	Tom Oak Hi 1 RL	Dr/Pc	Tom	6074	Tom Brush Mid St	Dr/Pc	Tom
5835	Trap HH 8 St	Dr/Pc	HHat	5915	Tom Power02 1-2St	Dr/Pc	Tom	5995	Tom Oak Hi 2 St	Dr/Pc	Tom	6075	Tom Brush Mid L	Dr/Pc	Tom
5836	Trap HH 9 St	Dr/Pc	HHat	5916	Tom Power02 1-2L	Dr/Pc	Tom	5996	Tom Oak Hi 2 L	Dr/Pc	Tom	6076	Tom Brush Mid R	Dr/Pc	Tom
5837	Trap OHH 1 St	Dr/Pc	HHat	5917	Tom Power02 1-2R	Dr/Pc	Tom	5997	Tom Oak Hi 2 R	Dr/Pc	Tom	6077	Tom Brush Mid RL	Dr/Pc	Tom
5838	Trap OHH 2 St	Dr/Pc	HHat	5918	Tom Power02 1-2RL	Dr/Pc	Tom	5998	Tom Oak Hi 2 RL	Dr/Pc	Tom	6078	Tom Brush Low St	Dr/Pc	Tom
5839	Trap OHH 3 St	Dr/Pc	HHat	5919	Tom Power02 1St	Dr/Pc	Tom	5999	Tom Oak Mid 1-2 St	Dr/Pc	Tom	6079	Tom Brush Low L	Dr/Pc	Tom
5840	HH 14inch St	Dr/Pc	HHat	5920	Tom Power02 1L	Dr/Pc	Tom	6000	Tom Oak Mid 1-2 L	Dr/Pc	Tom	6080	Tom Brush Low R	Dr/Pc	Tom

No.	Name	Main Category	Sub Category	No.	Name	Main Category	Sub Category	No.	Name	Main Category	Sub Category	No.	Name	Main Category	Sub Category
6081	Tom Brush Low RL	Dr/Pc	Tom	6161	Light Tom High St	Dr/Pc	Tom	6241	Ride Warm St	Dr/Pc	Cymb	6321	Electro Crash 2 St	Dr/Pc	Cymb
6082	Tom Brush Floor St	Dr/Pc	Tom	6162	Light Tom Low St	Dr/Pc	Tom	6242	Ride Warm L	Dr/Pc	Cymb	6322	EDM Crash St	Dr/Pc	Cymb
6083	Tom Brush Floor L	Dr/Pc	Tom	6163	Powerful Tom High St	Dr/Pc	Tom	6243	Ride Warm R	Dr/Pc	Cymb	6323	Novelly Crash	Dr/Pc	Cymb
6084	Tom Brush Floor R	Dr/Pc	Tom	6164	Powerful Tom Mid St	Dr/Pc	Tom	6244	Ride Warm RL	Dr/Pc	Cymb	6324	Flange Crash St	Dr/Pc	Cymb
6085	Tom Brush Floor RL	Dr/Pc	Tom	6165	Powerful Tom Low St	Dr/Pc	Tom	6245	Ride Njz St	Dr/Pc	Cymb	6325	Crackie Crash St	Dr/Pc	Cymb
6086	Tom Jazz H Sw	Dr/Pc	Tom	6166	Elec SE Tom St	Dr/Pc	Tom	6246	Ride Njz L	Dr/Pc	Cymb	6326	Electric Crash St	Dr/Pc	Cymb
6087	Tom Jazz M Sw	Dr/Pc	Tom	6167	Fine Light Tom St	Dr/Pc	Tom	6247	Ride Njz R	Dr/Pc	Cymb	6327	FX Crash St	Dr/Pc	Cymb
6088	Tom Jazz LH Sw	Dr/Pc	Tom	6168	HipHop Tom High Mn	Dr/Pc	Tom	6248	Ride Njz RL	Dr/Pc	Cymb	6328	Phase Crash St	Dr/Pc	Cymb
6089	Tom Jazz LL Sw	Dr/Pc	Tom	6169	HipHop Tom Mid Mn	Dr/Pc	Tom	6249	Ride Njz Cup St	Dr/Pc	Cymb	6329	Ride T9-1	Dr/Pc	Cymb
6090	Tom Jazz FLR Sw	Dr/Pc	Tom	6170	HipHop Tom Floor Mn	Dr/Pc	Tom	6250	Ride Njz Cup L	Dr/Pc	Cymb	6330	Ride T9-2	Dr/Pc	Cymb
6091	Tom Mono Hi	Dr/Pc	Tom	6171	Crash1 St	Dr/Pc	Cymb	6251	Ride Njz Cup R	Dr/Pc	Cymb	6331	Hard T9 CymRide	Dr/Pc	Cymb
6092	Tom Mono Lo	Dr/Pc	Tom	6172	Crash1 L	Dr/Pc	Cymb	6252	Ride Njz Cup RL	Dr/Pc	Cymb	6332	Elec T9 CymRide	Dr/Pc	Cymb
6093	Tom Dry Hi	Dr/Pc	Tom	6173	Crash1 R	Dr/Pc	Cymb	6253	Ride Cup1 St	Dr/Pc	Cymb	6333	Ride RX11	Dr/Pc	Cymb
6094	Tom Dry Lo	Dr/Pc	Tom	6174	Crash1 RL	Dr/Pc	Cymb	6254	Ride Cup1 L	Dr/Pc	Cymb	6334	Dub Ride St	Dr/Pc	Cymb
6095	Rotary Tom Hi 1-2	Dr/Pc	Tom	6175	Crash2 St	Dr/Pc	Cymb	6255	Ride Cup1 R	Dr/Pc	Cymb	6335	Trap Ride St	Dr/Pc	Cymb
6096	Rotary Tom Hi 1	Dr/Pc	Tom	6176	Crash2 L	Dr/Pc	Cymb	6256	Ride Cup1 RL	Dr/Pc	Cymb	6336	EDM Ride St	Dr/Pc	Cymb
6097	Rotary Tom Hi 2	Dr/Pc	Tom	6177	Crash2 R	Dr/Pc	Cymb	6257	Dynamic Ride	Dr/Pc	Cymb	6337	House Ride St	Dr/Pc	Cymb
6098	Rotary Tom Mid 1-2	Dr/Pc	Tom	6178	Crash2 RL	Dr/Pc	Cymb	6258	ZJ Ride1 Tip Sw	Dr/Pc	Cymb	6338	Electro Ride Mn	Dr/Pc	Cymb
6099	Rotary Tom Mid 1	Dr/Pc	Tom	6179	Crash3	Dr/Pc	Cymb	6259	ZJ Ride1 Cup Sw	Dr/Pc	Cymb	6339	Live Ride St	Dr/Pc	Cymb
6100	Rotary Tom Mid 2	Dr/Pc	Tom	6180	Crash4	Dr/Pc	Cymb	6260	ZJ Ride2 Tip Sw	Dr/Pc	Cymb	6340	Fresh Ride St	Dr/Pc	Cymb
6101	Rotary Tom Lo 1-2	Dr/Pc	Tom	6181	Crash Brite St	Dr/Pc	Cymb	6261	Std Ride	Dr/Pc	Cymb	6341	Fine Ride St	Dr/Pc	Cymb
6102	Rotary Tom Lo 1	Dr/Pc	Tom	6182	Crash Brite L	Dr/Pc	Cymb	6262	Fine Ride Bow	Dr/Pc	Cymb	6342	Clang Ride St	Dr/Pc	Cymb
6103	Rotary Tom Lo 2	Dr/Pc	Tom	6183	Crash Brite R	Dr/Pc	Cymb	6263	Fine Ride Edge	Dr/Pc	Cymb	6343	Smith Ride St	Dr/Pc	Cymb
6104	Tom Ambience Hi	Dr/Pc	Tom	6184	Crash Brite RL	Dr/Pc	Cymb	6264	Fine Ride Cup	Dr/Pc	Cymb	6344	HipHop Ride St	Dr/Pc	Cymb
6105	Tom Ambience Lo	Dr/Pc	Tom	6185	Crash Dark St	Dr/Pc	Cymb	6265	Ride Brush1 St	Dr/Pc	Cymb	6345	Ride Hip Hop St	Dr/Pc	Cymb
6106	Tom T9 Hi	Dr/Pc	Tom	6186	Crash Dark L	Dr/Pc	Cymb	6266	Ride Brush1 L	Dr/Pc	Cymb	6346	Reverse Cymbal1	Dr/Pc	Cymb
6107	Tom T9 Lo	Dr/Pc	Tom	6187	Crash Dark R	Dr/Pc	Cymb	6267	Ride Brush1 R	Dr/Pc	Cymb	6347	Reverse Cymbal2	Dr/Pc	Cymb
6108	T9 TomH 1 High	Dr/Pc	Tom	6188	Crash Dark RL	Dr/Pc	Cymb	6268	Ride Brush1 RL	Dr/Pc	Cymb				
6109	T9 TomH 1 Mid H	Dr/Pc	Tom	6189	Crash NjzA St	Dr/Pc	Cymb	6269	Ride Brush2 St	Dr/Pc	Cymb				
6110	T9 TomH 1 Mid L	Dr/Pc	Tom	6190	Crash NjzA L	Dr/Pc	Cymb	6270	Ride Brush2 L	Dr/Pc	Cymb				
6111	T9 TomH 1 Low H	Dr/Pc	Tom	6191	Crash NjzA R	Dr/Pc	Cymb	6271	Ride Brush2 R	Dr/Pc	Cymb				
6112	T9 TomH 1 Lo L	Dr/Pc	Tom	6192	Crash NjzA RL	Dr/Pc	Cymb	6272	Ride Brush2 RL	Dr/Pc	Cymb				
6113	T9 TomH 2 High	Dr/Pc	Tom	6193	Crash NjzB St	Dr/Pc	Cymb	6273	Ride Brush3 Tip Sw	Dr/Pc	Cymb				
6114	T9 TomH 2 Mid H	Dr/Pc	Tom	6194	Crash NjzB L	Dr/Pc	Cymb	6274	Ride Brush3 Cup Sw	Dr/Pc	Cymb				
6115	T9 TomH 2 Mid L	Dr/Pc	Tom	6195	Crash NjzB R	Dr/Pc	Cymb	6275	Ride Brush4 Cup Sw	Dr/Pc	Cymb				
6116	T9 TomH 2 Low H	Dr/Pc	Tom	6196	Crash NjzB RL	Dr/Pc	Cymb	6276	Ride Cup2 St	Dr/Pc	Cymb				
6117	T9 TomH 2 Lo L	Dr/Pc	Tom	6197	Std Crash1	Dr/Pc	Cymb	6277	Ride Cup2 L	Dr/Pc	Cymb				
6118	T9 TomH 3 High	Dr/Pc	Tom	6198	Std Crash2	Dr/Pc	Cymb	6278	Ride Cup2 R	Dr/Pc	Cymb				
6119	T9 TomH 3 Mid H	Dr/Pc	Tom	6199	PI Crash 15	Dr/Pc	Cymb	6279	Ride Cup2 RL	Dr/Pc	Cymb				
6120	T9 TomH 3 Mid L	Dr/Pc	Tom	6200	PI Crash 16	Dr/Pc	Cymb	6280	Ride Mono	Dr/Pc	Cymb				
6121	T9 TomH 3 Low H	Dr/Pc	Tom	6201	ZJ Crash1 Sw	Dr/Pc	Cymb	6281	Ride Cup Mono	Dr/Pc	Cymb				
6122	T9 TomH 3 Lo L	Dr/Pc	Tom	6202	ZJ Crash2 Sw	Dr/Pc	Cymb	6282	Ride Cup Mono2	Dr/Pc	Cymb				
6123	Tom T8	Dr/Pc	Tom	6203	ZJ Crash3 Sw	Dr/Pc	Cymb	6283	China1 St	Dr/Pc	Cymb				
6124	T8 Tom High Ac	Dr/Pc	Tom	6204	Jazz Crash1 Sw	Dr/Pc	Cymb	6284	China1 L	Dr/Pc	Cymb				
6125	T8 Tom High NA	Dr/Pc	Tom	6205	Jazz Crash2 Sw	Dr/Pc	Cymb	6285	China1 R	Dr/Pc	Cymb				
6126	T8 Tom Low Ac	Dr/Pc	Tom	6206	Crash Brush1 St	Dr/Pc	Cymb	6286	China1 RL	Dr/Pc	Cymb				
6127	T8 Tom Low NA	Dr/Pc	Tom	6207	Crash Brush1 L	Dr/Pc	Cymb	6287	China2	Dr/Pc	Cymb				
6128	Elec T8 Tom High	Dr/Pc	Tom	6208	Crash Brush1 R	Dr/Pc	Cymb	6288	China3 St	Dr/Pc	Cymb				
6129	Elec T8 Tom Mid	Dr/Pc	Tom	6209	Crash Brush1 RL	Dr/Pc	Cymb	6289	China3 L	Dr/Pc	Cymb				
6130	Elec T8 Tom Low	Dr/Pc	Tom	6210	Crash Brush Cup St	Dr/Pc	Cymb	6290	China3 R	Dr/Pc	Cymb				
6131	Tom Syn1	Dr/Pc	Tom	6211	Crash Brush Cup L	Dr/Pc	Cymb	6291	China3 RL	Dr/Pc	Cymb				
6132	Tom Syn2	Dr/Pc	Tom	6212	Crash Brush Cup R	Dr/Pc	Cymb	6292	China4	Dr/Pc	Cymb				
6133	Tom AnSm	Dr/Pc	Tom	6213	Crash Brush Cup RL	Dr/Pc	Cymb	6293	Splash1 St	Dr/Pc	Cymb				
6134	Tom Dist Hi	Dr/Pc	Tom	6214	Crash Brush2 St	Dr/Pc	Cymb	6294	Splash1 L	Dr/Pc	Cymb				
6135	Tom Dist Lo	Dr/Pc	Tom	6215	Crash Brush2 L	Dr/Pc	Cymb	6295	Splash1 R	Dr/Pc	Cymb				
6136	Tom RX11	Dr/Pc	Tom	6216	Crash Brush2 R	Dr/Pc	Cymb	6296	Splash1 RL	Dr/Pc	Cymb				
6137	Comp EleTom High	Dr/Pc	Tom	6217	Crash Brush2 RL	Dr/Pc	Cymb	6297	Splash2 St	Dr/Pc	Cymb				
6138	Comp EleTom Low	Dr/Pc	Tom	6218	ZJ Crash Brush Sw	Dr/Pc	Cymb	6298	Splash2 L	Dr/Pc	Cymb				
6139	Dub Tom Mn	Dr/Pc	Tom	6219	Hand Cymbal Open St	Dr/Pc	Cymb	6299	Splash2 R	Dr/Pc	Cymb				
6140	EDM Tom High Mn	Dr/Pc	Tom	6220	Hand Cymbal Open L	Dr/Pc	Cymb	6300	Splash2 RL	Dr/Pc	Cymb				
6141	EDM Tom Mid Mn	Dr/Pc	Tom	6221	Hand Cymbal Open R	Dr/Pc	Cymb	6301	ZJ Splash1	Dr/Pc	Cymb				
6142	EDM Tom Low Mn	Dr/Pc	Tom	6222	Hand Cymbal Mute St	Dr/Pc	Cymb	6302	ZJ Splash2 Sw	Dr/Pc	Cymb				
6143	Zap Tom H Mn	Dr/Pc	Tom	6223	Hand Cymbal Mute L	Dr/Pc	Cymb	6303	Crash T9-1	Dr/Pc	Cymb				
6144	Zap Tom M Mn	Dr/Pc	Tom	6224	Hand Cymbal Mute R	Dr/Pc	Cymb	6304	Crash T9-2	Dr/Pc	Cymb				
6145	Zap Tom L Mn	Dr/Pc	Tom	6225	Ride1 St	Dr/Pc	Cymb	6305	Crash T8-1	Dr/Pc	Cymb				
6146	House Tom Hi H Mn	Dr/Pc	Tom	6226	Ride1 L	Dr/Pc	Cymb	6306	Crash T8-2-1	Dr/Pc	Cymb				
6147	House Tom Hi L Mn	Dr/Pc	Tom	6227	Ride1 R	Dr/Pc	Cymb	6307	Crash T8-2-2	Dr/Pc	Cymb				
6148	House Tom Mid H Mn	Dr/Pc	Tom	6228	Ride1 RL	Dr/Pc	Cymb	6308	Crash T8-2-3	Dr/Pc	Cymb				
6149	House Tom Mid M Mn	Dr/Pc	Tom	6229	Ride2 St	Dr/Pc	Cymb	6309	S&H T8 Crash	Dr/Pc	Cymb				
6150	House Tom Mid L Mn	Dr/Pc	Tom	6230	Ride2 L	Dr/Pc	Cymb	6310	Crash Syn	Dr/Pc	Cymb				
6151	House Tom Lo H Mn	Dr/Pc	Tom	6231	Ride2 R	Dr/Pc	Cymb	6311	Crash RX11	Dr/Pc	Cymb				
6152	House Tom Lo L Mn	Dr/Pc	Tom	6232	Ride2 RL	Dr/Pc	Cymb	6312	Dub Crash Mn	Dr/Pc	Cymb				
6153	Electro Tom Hi H Mn	Dr/Pc	Tom	6233	Ride Brite St	Dr/Pc	Cymb	6313	Trap Crash 1 Mn	Dr/Pc	Cymb				
6154	Electro Tom Hi L Mn	Dr/Pc	Tom	6234	Ride Brite L	Dr/Pc	Cymb	6314	Trap Crash 2 St	Dr/Pc	Cymb				
6155	Electro Tom Mid H Mn	Dr/Pc	Tom	6235	Ride Brite R	Dr/Pc	Cymb	6315	HipHop Crash 1 St	Dr/Pc	Cymb				
6156	Electro Tom Mid L Mn	Dr/Pc	Tom	6236	Ride Brite RL	Dr/Pc	Cymb	6316	HipHop Crash 2 St	Dr/Pc	Cymb				
6157	Electro Tom Lo H Mn	Dr/Pc	Tom	6237	Ride Brite Cup St	Dr/Pc	Cymb	6317	HipHop Crash 3 St	Dr/Pc	Cymb				
6158	Electro Tom Lo L Mn	Dr/Pc	Tom	6238	Ride Brite Cup L	Dr/Pc	Cymb	6318	HipHop Crash 4 Mn	Dr/Pc	Cymb				
6159	Digital Tom High St	Dr/Pc	Tom	6239	Ride Brite Cup R	Dr/Pc	Cymb	6319	House Crash St	Dr/Pc	Cymb				
6160	Digital Tom Low St	Dr/Pc	Tom	6240	Ride Brite Cup RL	Dr/Pc	Cymb	6320	Electro Crash 1 St	Dr/Pc	Cymb				

Live Set List

Best of MONTAGE 1

	Perf Name	Slot Name	Color
1	CFX + FM EP	A.PIANO CFX+FM EP	Blue
2	Wax And Wane	SYN PAD w/ Auto SK	Pink
3	Pearly Gates	CHILL OUT Style ARP	Lilac
4	DJ Montage	DANCE Style ARP	Red
5	Rd 1 Gallery	E. PIANO RD	Blue
6	Ocean Pad	SYN PAD	Pink
7	Monster Lead	SYN LEAD	Yellow
8	Tektonic Dub	DANCE Style ARP	Red
9	Wr Gallery	E. PIANO WR	Blue
10	Seattle Sections	STRINGS Ensemble	Lime
11	FM Linear Synth	SYN PAD	Pink
12	Particles in Space	SYN PAD	Pink
13	All 9 Bars!	ORGAN	Organge
14	8 Amps and a TC	E.GUITAR Clean	Azure
15	Multi Saw MW DA	SYN COMP	Purple
16	Turn It On	SYN COMP w/ M.SEQ	Purple

Spiralizer + Synth

	Perf Name	Slot Name	Color
1	FM Spiral Dist	M.EFX w/ SPIRALIZER	Cream
2	Santur-A-Delic	FMSANTURw/SPIRALIZER	Aqua
3	Hybrid Sync	SYN LD w/ SPIRALIZER	Yellow
4	Spirals	M.EFX w/ SPIRALIZER	Cream
5	Spiral Feedbacker	S.EFX w/ SPIRALIZER	Cream
6	FM Sync	SYN LD w/ SPIRALIZER	Yellow
7	Iceworld	M.EFX w/ SPIRALIZER	Cream
8	Creeping Voltage	S.EFX w/ SPIRALIZER	Cream
9	FM Spectral Spheres	MUSICAL FX w/ M.SEQ	Cream
10	Granular Motion	MUSICAL FX	Cream
11	Trap 'n' Bass	DANCE Style ARP	Red
12	Illuminator	DANCE Style ARP	Red
13	The Hybrid BRASS Sec	BRASS Ensemble	Sakura
14	PopBrass & SynBrass	BRASS Ensemble	Sakura
15	Judgement Bass	SYN BASS	Beige
16	Freaky Dancer	DANCE Style ARP	Red

Best of MONTAGE 2

	Perf Name	Slot Name	Color
1	CFX & Pad & Sub	PIANO + PAD + BASS	Blue
2	SparkleDegree Full	E.PIANO	Blue
3	Motion Filters AF	MUSICAL FX w/ M.SEQ	Cream
4	T3 Uber funk	FUNK ARP w/M. SEQ	Red
5	AcPfl+FM Pfl+Pad DA	PIANO+FM EP+PAD	Blue
6	Cathedral	PIPE <-> CHURCH	Organge
7	Universal Comp	SYN PAD	Pink
8	Mr. Side Chain	DANCE Style ARP	Red
9	Upright Mod 1	A.PIANO Upright	Blue
10	Two Acoustics 2	A.GUITAR	Azure
11	Wave Surfer	MUSICAL FX w/ M.SEQ	Cream
12	EDM PITCh Bomb	DANCE Style ARP	Red
13	Full AP/EP/Pd/Str	PIANO+PAD+STRINGS	Blue
14	Far Away FM	SYN BELL	Mint
15	Marine Life	FX Style ARP	Lilac
16	Kreuzberg Funk	DANCE Style ARP	Red

Motion Synth

	Perf Name	Slot Name	Color
1	SuperGlider MW DA	MUSICAL FX w/ M.SEQ	Beige
2	Choir SEQ	MUSICAL FX w/ M.SEQ	Beige
3	Motion PAD & ARP	FX Style ARP w/ MS	Lilac
4	Surprise Package	DANCE Style ARP	Red
5	Flexi Filters AF1&2	MUSICAL FX w/ AutoSK	Beige
6	M-Seq Choir Pad	SYN PAD w/ M.SEQ	Pink
7	Orient Envelope	MUSICAL FX w/ M.SEQ	Beige
8	Synth Noise Vocoder	FX Style ARP	Lilac
9	Envelope Seq Scenes	MUSICAL FX w/ AutoSK	Beige
10	Dernt to Bwow	FX Style ARP	Lilac
11	Polyphonic LFOs	MUSICAL FX	Beige
12	Increasing Tension	FX Style ARP	Lilac
13	WaveRunner MW DA	MUSICAL FX w/ AutoSK	Beige
14	Cold Motion	MUSICAL FX	Beige
15	Morph Waveforms	SYN PAD	Pink
16	The Great Red Spot	MUSICAL FX	Beige

Best of MOTIF XF

	Perf Name	Slot Name	Color
1	Piano Electro	CHILL OUT Style ARP	Lilac
2	Orchestra Del Mar	CHILL OUT Style ARP	Lilac
3	Son of Mars	ORCHESTRA	Lime
4	Sprinkler	MUSICAL FX	Cream
5	Yamaha Concerto	ORCHESTRA	Lime
6	Worship Center	ORCHESTRA	Lime
7	Angel Pad	SYN PAD	Pink
8	Crying Scene	SYN PAD	Pink
9	Inner Wind	DANCE Style ARP	Red
10	Just Relax	CHILL OUT Style ARP	Lilac
11	Secret Film	CHILL OUT Style ARP	Lilac
12	Kogarashi	PIPE Ethnic/SYN PAD	Aqua
13	Electrix	DANCE Style ARP	Red
14	Triathlon	CHILL OUT Style ARP	Lilac
15	Movie Strings	STRINGS Ensemble	Lime
16	Plutonium Freezer	DANCE Style ARP	Red

FM

	Perf Name	Slot Name	Color
1	FM CS80 Brass	BRASS	Sakura
2	FM PWM Pad	SYN PAD	Pink
3	FM Wr 1	E.PIANO	Blue
4	FM Marimba	MALLET	Mint
5	Clavi Stuff	CLAVI FM	Blue
6	FM Chillout	MUSICAL FX	Cream
7	FM Heavenly Pad	SYN PAD	Pink
8	FM Lately Bass	BASS FM	Beige
9	FM Syn Lead 3	SYN LEAD	Yellow
10	FM Wave Dreams	SYN COMP	Purple
11	FM Warm Shivers	SYN PAD	Pink
12	FM Forest Pad	SYN PAD	Pink
13	FM Lullaby AF1&2	SYN BELL	Mint
14	Drift & Pulse	SYN PAD	Pink
15	FM Choir	SYN PAD	Pink
16	FM Landscapes	SOUND FX	Cream

Motion Control

	Perf Name	Slot Name	Color
1	Yo Luv	STRINGS+PIANO	Lime
2	Bit Performer	MUSICAL FX	Cream
3	Praise Mr. 80	SYN PAD	Pink
4	Galactic Nucleus	SYN PAD	Pink
5	Glistening Grove	SYN PAD	Pink
6	Ocean Pad	SYN PAD	Pink
7	Filter & Funky	SYN PAD	Pink
8	Trigger Horizon	SYN PAD	Pink
9	FM Landscapes	SOUND FX	Cream
10	Cricket Night	MUSICAL FX	Cream
11	Freaky FM AF1&2	MUSICAL FX	Cream
12	Waveseq FM	MUSICAL FX	Cream
13	Run It	MUSICAL FX	Cream
14	Electro Boo	MUSICAL FX	Cream
15	Under Dirt	MUSICAL FX	Cream
16	Pearly Gates	MUSICAL FX	Cream

ORGAN

	Perf Name	Slot Name	Color
1	The Basics	Organ	Orange
2	8.8.8.8.6.2.2.0.0.2	Organ	Orange
3	Rock Hard	Organ	Orange
4	Foolish Organ	Organ w/ M.SEQ	Orange
5	The Preacher 2	Organ	Orange
6	Lovin' Happiness	Organ	Orange
7	Lake Fire	Organ	Orange
8	Tempo Bars	Organ w/ M.SEQ	Orange
9	Evens and Odds	Organ	Orange
10	J's Jazz 2	Organ	Orange
11	Bowed Bars CV	Organ	Orange
12	Digital Tonewheels	Organ	Orange
13	Glassy	Organ	Orange
14	Jazz To All Out 2	Organ	Orange
15	Two Blue Hands	Organ	Orange
16	Flying Bars	Organ w/ M.SEQ	Orange

KEYBOARD 1

	Perf Name	Slot Name	Color
1	CFX Concert	A.PIANO CFX	Blue
2	CFX Pop/Rock	A.PIANO CFX	Blue
3	CFX + FM EP	A.PIANO CFX+FM EP	Blue
4	CFX Shrine	A.PIANO CFX+SYN PAD	Blue
5	CFX Padded	A.PIANO CFX+SYN PAD	Blue
6	S700 for Montage	A.PIANO	Blue
7	Upright Piano	A.PIANO Upright	Blue
8	Upright Mod 1	A.PIANO Upright	Blue
9	Cold Upright	A.PIANO Upright	Blue
10	Acoustic Piano DA	PIANO	Blue
11	FM EP & CFX Grand	A.PIANO CFX+FM EP	Blue
12	Full AP/EP/Pd/Str	PIANO+PAD+STRINGS	Blue
13	CP80	PIANO CP	Blue
14	CP80 & Pad	PIANO CP+SYN PAD	Blue
15	FM Grand Piano	PIANO FM	Blue
16	DX CP	PIANO FM	Blue

SYNTH 1

	Perf Name	Slot Name	Color
1	Singleline 2	SYN LEAD	Yellow
2	EDM PITCh Bomb	DANCE Style ARP	Red
3	FM MotionSeq Ld DA	SYN LEAD	Yellow
4	FM Syn Lead 3	SYN LEAD	Yellow
5	Anemone Lead	SYN LEAD	Yellow
6	Soft and Dirty FM	SYN LEAD	Yellow
7	Kool FM Disco Lead	SYN LEAD	Yellow
8	Growling Wolf	DANCE Style ARP	Red
9	Legato Pitcher	SYN LEAD ARP	Yellow
10	Wax And Wane	SYN PAD w/ Auto SK	Pink
11	Trigger Horizon	SYN PAD	Pink
12	Padderday	SYN PAD	Pink
13	FM PWM Pad	SYN PAD	Pink
14	Poly Pad MW DA	SYN PAD	Pink
15	FM Ice Heaven Pad	SYN PAD	Pink
16	Schlager Weapon 4	SYN PAD	Pink

KEYBOARD 2

	Perf Name	Slot Name	Color
1	Rd 1 Gallery	E.PIANO RD	Blue
2	74 Phase	E.PIANO RD	Blue
3	Wr Gallery	E.PIANO WR	Blue
4	FM Piano DA	E.PIANO FM	Blue
5	SparkleDegree Full	E.PIANO	Blue
6	Toy EP	E.PIANO	Blue
7	Clavi Amp Gallery	CLAVI	Blue
8	PhaserClavi Mt AF1	CLAVI	Blue
9	Clavi Stuff	CLAVI FM	Blue
10	All 9 Bars!	ORGAN	Organge
11	Hot Smoky	ORGAN	Organge
12	Overdriven Organ	ORGAN	Organge
13	The Preacher	ORGAN	Organge
14	FM YC Combo Organ	ORGAN FM	Organge
15	Cathedral	PIPE <-> CHURCH	Organge
16	AccordionTrnsfrmer	ACCORDION	Organge

SYNTH 2

	Perf Name	Slot Name	Color
1	Momentary FM	SYN PAD	Pink
2	Isle of Skye	SYN PAD	Pink
3	Ethereal	SYN PAD	Pink
4	Universal Comp	SYN PAD	Pink
5	Octo Supreme	SYN PAD	Pink
6	R's Logo	SYN PAD	Pink
7	FM Sweeping Poly	SYN PAD	Pink
8	That's a Pad	SYN PAD	Pink
9	FM Linear Synth	SYN PAD	Pink
10	Jazz Singers	CHOIR	Pink
11	Particles in Space	SYN PAD	Pink
12	Mr. Side Chain	DANCE Style ARP	Red
13	Breathless Safri	SYN COMP	Purple
14	Schlager Weapon 2	SYN COMP	Purple
15	Turn It On	SYN COMP w/ M.SEQ	Purple
16	Kool Dis Comp	SYN COMP	Purple

SYNTH 3

	Perf Name	Slot Name	Color
1	FM Two Kalimbas	SYN COMP	Purple
2	FM Hard Comp	SYN COMP	Purple
3	Multi Saw MW DA	SYN COMP	Purple
4	DJ Montage	DANCE Style ARP	Red
5	The Green Flash	MUSICAL FX	Cream
6	FM For Airports	MUSICAL FX	Cream
7	Kreuzberg Funk	DANCE Style ARP	Red
8	Electron	DANCE Style ARP	Red
9	Envelope Beatz	CHILL OUT Style ARP	Lilac
10	FM Tribal Council	MUSICAL FX	Cream
11	Motion Sweep	MUSICAL FX	Cream
12	Marine Life	FX Style ARP	Lilac
13	Wave Surfer	MUSICAL FX w/ M.SEQ	Cream
14	Motion Filters AF	MUSICAL FX w/ M.SEQ	Cream
15	FM Flight	SOUND FX	Cream
16	MOON BASE	SOUND FX	Cream

C.PERC/DRUMS&PERC

	Perf Name	Slot Name	Color
1	Bell Majestic	BELL	Mint
2	Far Away FM	SYN BELL	Mint
3	FM Marimba	MALLET	Mint
4	FM Tubular Bells	SYN BELL	Mint
5	Super Bell	SYN BELL	Mint
6	FM Japanese Taiko	C.PERC	Mint
7	Experimental Work	DANCE Style ARP	Red
8	FM Techre	DANCE Style ARP	Red
9	Real Drums Kit	DRUM/PERC	Green
10	New Oak Custom Kit	DRUM/PERC	Green
11	T's EDM Kit	DRUM/PERC	Green
12	T's Hip Hop Kit	DRUM/PERC	Green
13	New Iranian Kit 1	DRUM/PERC	Green
14	Brazil Kit 1	DRUM/PERC	Green
15	Turkish St Kit	DRUM/PERC	Green
16	New Arabic Kit 1	DRUM/PERC	Green

ORCHESTRA

	Perf Name	Slot Name	Color
1	Solo 1st Violin AF1	STRINGS Solo	Lime
2	Solo Viola AF1	STRINGS Solo	Lime
3	Solo Cello AF1	STRINGS Solo	Lime
4	Seattle Sections	STRINGS Ensemble	Lime
5	Strings & Brass	ORCHESTRA	Lime
6	Orch Trumpets	BRASS Ensemble	Sakura
7	Orch Trombones	BRASS Ensemble	Sakura
8	Orchestra Horns	BRASS Ensemble	Sakura
9	Orchestral Brass	BRASS Ensemble	Sakura
10	Concert Flute	FLUTE	Sakura
11	Oboe 3	WOODWIND	Sakura
12	Orch Clarinet	WOODWIND	Sakura
13	Bassoon 3	WOODWIND	Sakura
14	Wind Ensemble	WOODWIND	Sakura
15	Low D Whistle	WOODWIND	Sakura
16	Pop Horns Bright	BRASS Ensemble	Sakura

GUITAR/BASS

	Perf Name	Slot Name	Color
1	6 String Finger	A.GUITAR	Azure
2	Fingered Steel	A.GUITAR	Azure
3	Picked Son of Gt	A.GUITAR	Azure
4	8 Amps and a TC	E.GUITAR Clean	Azure
5	Clean Fingers	E.GUITAR Clean	Azure
6	TC Clean Pick	E.GUITAR Clean	Azure
7	Lead Feedbacker	E.GUITAR Dist	Azure
8	Modern Pick Hero	E.GUITAR Dist	Azure
9	FM The Jazz Guitar	GUITAR FM	Azure
10	Upright Bass AF1	A.BASS	Beige
11	DX SuperBass+ DA	BASS FM	Beige
12	FM Syn Bass	BASS FM	Beige
13	FM Lately Bass	BASS FM	Beige
14	T3 Uber funk	FUNK ARP w/M. SEQ	Red
15	Warped Bass Traxx	DANCE Style ARP	Red
16	Tektonic Dub	DANCE Style ARP	Red

Arpeggio Type List

*1 The new Arpeggio Types added by firmware version 2.00 update.

Main Category	Sub Category	ARP No.	ARP Name	Time Signature	Length	Original Tempo	Accent	Random SFX	Sound Type
Piano	Rock	1	MA_70s Rock_N	4/4	2	130			Acoustic Piano
Piano	Rock	2	MB_70s Rock_N	4/4	1	130			:
Piano	Rock	3	MC_70s Rock	4/4	2	130			:
Piano	Rock	4	MD_70s Rock	4/4	4	130			:
Piano	Rock	5	FA_70s Rock	4/4	1	130			:
Piano	Rock	6	FB_70s Rock_N	4/4	1	130			:
Piano	Rock	7	FC_70s Rock_N	4/4	2	130			:
Piano	Rock	8	MA_Rockn Pl	4/4	4	130			:
Piano	Rock	9	MA_Rock & Roll_C	4/4	4	172			:
Piano	Rock	10	MB_Rock & Roll_C	4/4	4	172			:
Piano	Rock	11	MC_Rock & Roll_C	4/4	4	172			:
Piano	Rock	12	FA_Rock & Roll_C	4/4	1	172			:
Piano	Rock	13	FB_Rock & Roll_C	4/4	1	172			:
Piano	Rock	14	FC_Rock & Roll_C	4/4	1	172			:
Piano	Rock	15	BA_Rock & Roll_C	4/4	1	172			:
Piano	Rock	16	EA_Rock & Roll_C	4/4	5	172			:
Piano	Rock	17	EB_Rock & Roll_C	4/4	6	172			:
Piano	Pop Rock	18	MA_Raw Beat_N	4/4	1	130			:
Piano	Pop Rock	19	MA_Pop Shuffle1_C	4/4	4	180			:
Piano	Pop Rock	20	MB_Pop Shuffle1_C	4/4	4	180			:
Piano	Pop Rock	21	MC_Pop Shuffle1_C	4/4	4	180			:
Piano	Pop Rock	22	MD_Pop Shuffle1_C	4/4	4	180			:
Piano	Pop Rock	23	FA_Pop Shuffle1_C	4/4	1	180			:
Piano	Pop Rock	24	FB_Pop Shuffle1_C	4/4	1	180			:
Piano	Pop Rock	25	FC_Pop Shuffle1_C	4/4	1	180			:
Piano	Pop Rock	26	FD_Pop Shuffle1_C	4/4	1	180			:
Piano	Pop Rock	27	EA_Pop Shuffle1_C	4/4	5	180			:
Piano	Pop Rock	28	MA_Swing MOR Pop_C	4/4	4	94			:
Piano	Pop Rock	29	MB_Swing MOR Pop_C	4/4	4	94			:
Piano	Pop Rock	30	MC_Swing MOR Pop_C	4/4	4	94			:
Piano	Pop Rock	31	MD_Swing MOR Pop_C	4/4	4	94			:
Piano	Pop Rock	32	FA_Swing MOR Pop_C	4/4	1	94			:
Piano	Pop Rock	33	FB_Swing MOR Pop_C	4/4	1	94			:
Piano	Pop Rock	34	FC_Swing MOR Pop_C	4/4	1	94			:
Piano	Pop Rock	35	FD_Swing MOR Pop_C	4/4	1	94			:
Piano	Pop Rock	36	EA_Swing MOR Pop_C	4/4	3	94			:
Piano	Pop Rock	37	MA_12/8 Pop_C	6/4	4	90			:
Piano	Pop Rock	38	MB_12/8 Pop_C	6/4	4	90			:
Piano	Pop Rock	39	MC_12/8 Pop_C	6/4	4	90			:
Piano	Pop Rock	40	MD_12/8 Pop_C	6/4	4	90			:
Piano	Pop Rock	41	FA_12/8 Pop_C	6/4	1	90			:
Piano	Pop Rock	42	FB_12/8 Pop_C	6/4	1	90			:
Piano	Pop Rock	43	FC_12/8 Pop_C	6/4	1	90			:
Piano	Pop Rock	44	FD_12/8 Pop_C	6/4	1	90			:
Piano	Pop Rock	45	EA_12/8 Pop_C	6/4	4	90			:
Piano	Pop Rock	46	MA_BritRockPop_C	4/4	4	123			:
Piano	Pop Rock	47	MB_BritRockPop_C	4/4	4	123			:
Piano	Pop Rock	48	MC_BritRockPop_C	4/4	4	123			:
Piano	Pop Rock	49	FA_BritRockPop_C	4/4	1	123			:
Piano	Pop Rock	50	FB_BritRockPop_C	4/4	1	123			:
Piano	Pop Rock	51	FC_BritRockPop_C	4/4	1	123			:
Piano	Pop Rock	52	BA_BritRockPop_C	4/4	1	123			:
Piano	Pop Rock	53	EA_BritRockPop_C	4/4	6	123			:
Piano	Pop Rock	54	MA_60sVintagePop_C	4/4	4	132			:
Piano	Pop Rock	55	MB_60sVintagePop_C	4/4	4	132			:
Piano	Pop Rock	56	MC_60sVintagePop_C	4/4	4	132			:
Piano	Pop Rock	57	FA_60sVintagePop_C	4/4	1	132			:
Piano	Pop Rock	58	FB_60sVintagePop_C	4/4	1	132			:
Piano	Pop Rock	59	FC_60sVintagePop_C	4/4	1	132			:
Piano	Pop Rock	60	BA_60sVintagePop_C	4/4	1	132			:
Piano	Pop Rock	61	EA_60sVintagePop_C	4/4	2	132			:
Piano	Pop Rock	62	MA_60sChartSwing_C	4/4	4	123			:
Piano	Pop Rock	63	MB_60sChartSwing_C	4/4	4	123			:
Piano	Pop Rock	64	MC_60sChartSwing_C	4/4	4	123			:
Piano	Pop Rock	65	FA_60sChartSwing_C	4/4	1	123			:
Piano	Pop Rock	66	FB_60sChartSwing_C	4/4	1	123			:
Piano	Pop Rock	67	FC_60sChartSwing_C	4/4	1	123			:
Piano	Pop Rock	68	BA_60sChartSwing_C	4/4	1	123			:
Piano	Pop Rock	69	EA_60sChartSwing_C	4/4	4	123			:
Piano	Pop Rock	70	MA_16Beat Pop 2_C	4/4	4	94			:
Piano	Pop Rock	71	MB_16Beat Pop 2_C	4/4	4	94			:
Piano	Pop Rock	72	MC_16Beat Pop 2_C	4/4	4	94			:
Piano	Pop Rock	73	FA_16Beat Pop 2_C	4/4	1	94			:
Piano	Pop Rock	74	FB_16Beat Pop 2_C	4/4	1	94			:
Piano	Pop Rock	75	FC_16Beat Pop 2_C	4/4	1	94			:
Piano	Pop Rock	76	BA_16Beat Pop 2_C	4/4	1	94			:
Piano	Pop Rock	77	MA_16Beat Pop 2_N	4/4	4	94			:
Piano	Pop Rock	78	MB_16Beat Pop 2_N	4/4	4	94			:
Piano	Pop Rock	79	MC_16Beat Pop 2_N	4/4	4	94			:
Piano	Pop Rock	80	FA_16Beat Pop 2_N	4/4	1	94			:
Piano	Pop Rock	81	FB_16Beat Pop 2_N	4/4	1	94			:
Piano	Pop Rock	82	FC_16Beat Pop 2_N	4/4	1	94			:
Piano	Pop Rock	83	BA_16Beat Pop 2_N	4/4	1	94			:
Piano	Pop Rock	84	MC1_Piano Club	4/4	1	96			:
Piano	Pop Rock	85	MD1_Piano Club	4/4	1	96			:
Piano	Pop Rock	86	IA1_Piano Club	4/4	1	96			:
Piano	Pop Rock	87	MD2_Piano Club	4/4	2	96			:

Main Category	Sub Category	ARP No.	ARP Name	Time Signature	Length	Original Tempo	Accent	Random SFX	Sound Type
Piano	Pop Rock	88	IA2_Piano Club	4/4	2	96			:
Piano	Pop Rock	89	MC3_Piano Club	4/4	2	96			:
Piano	Pop Rock	90	IA3_Piano Club	4/4	2	96			:
Piano	Ballad	91	MA_12/8 Ballad_C	4/4	4	60			:
Piano	Ballad	92	MB_12/8 Ballad_C	4/4	4	60			:
Piano	Ballad	93	MC_12/8 Ballad_C	4/4	4	60			:
Piano	Ballad	94	MD_12/8 Ballad_C	4/4	4	60			:
Piano	Ballad	95	FA_12/8 Ballad_C	4/4	1	60			:
Piano	Ballad	96	FB_12/8 Ballad_C	4/4	1	60			:
Piano	Ballad	97	FC_12/8 Ballad_C	4/4	1	60			:
Piano	Ballad	98	FD_12/8 Ballad_C	4/4	1	60			:
Piano	Ballad	99	EA_12/8 Ballad_C	4/4	3	60			:
Piano	Ballad	100	MA_Unplugged 1_C	4/4	4	120			:
Piano	Ballad	101	MB_Unplugged 1_C	4/4	4	120			:
Piano	Ballad	102	MC_Unplugged 1_C	4/4	4	120			:
Piano	Ballad	103	FA_Unplugged 1_C	4/4	1	120			:
Piano	Ballad	104	FB_Unplugged 1_C	4/4	1	120			:
Piano	Ballad	105	FC_Unplugged 1_C	4/4	1	120			:
Piano	Ballad	106	BA_Unplugged 1_C	4/4	1	120			:
Piano	Ballad	107	MA_Unplugged 3_C	4/4	4	113			:
Piano	Ballad	108	MB_Unplugged 3_C	4/4	4	113			:
Piano	Ballad	109	MC_Unplugged 3_C	4/4	4	113			:
Piano	Ballad	110	FA_Unplugged 3_C	4/4	1	113			:
Piano	Ballad	111	FB_Unplugged 3_C	4/4	1	113			:
Piano	Ballad	112	FC_Unplugged 3_C	4/4	1	113			:
Piano	Ballad	113	BA_Unplugged 3_C	4/4	1	113			:
Piano	Ballad	114	MA_Unplugged 3_N	4/4	4	113			:
Piano	Ballad	115	MB_Unplugged 3_N	4/4	4	113			:
Piano	Ballad	116	MC_Unplugged 3_N	4/4	4	113			:
Piano	Ballad	117	FA_Unplugged 3_N	4/4	1	113			:
Piano	Ballad	118	FB_Unplugged 3_N	4/4	1	113			:
Piano	Ballad	119	FC_Unplugged 3_N	4/4	1	113			:
Piano	Ballad	120	BA_Unplugged 3_N	4/4	1	113			:
Piano	Ballad	121	MA1_8Beat Slow_C	4/4	4	78			:
Piano	Ballad	122	MB1_8Beat Slow_C	4/4	4	78			:
Piano	Ballad	123	MC1_8Beat Slow_C	4/4	4	78			:
Piano	Ballad	124	FA1_8Beat Slow_C	4/4	1	78			:
Piano	Ballad	125	FB1_8Beat Slow_C	4/4	1	78			:
Piano	Ballad	126	FC1_8Beat Slow_C	4/4	1	78			:
Piano	Ballad	127	BA1_8Beat Slow_C	4/4	1	78			:
Piano	Ballad	128	MA1_8Beat Slow_N	4/4	4	78			:
Piano	Ballad	129	MB1_8Beat Slow_N	4/4	4	78			:
Piano	Ballad	130	MC1_8Beat Slow_N	4/4	4	78			:
Piano	Ballad	131	FA1_8Beat Slow_N	4/4	1	78			:
Piano	Ballad	132	FB1_8Beat Slow_N	4/4	1	78			:
Piano	Ballad	133	FC1_8Beat Slow_N	4/4	1	78			:
Piano	Ballad	134	BA1_8Beat Slow_N	4/4	1	78			:
Piano	Hip Hop	135	MA_Synth Piano01	4/4	2	148			:
Piano	Hip Hop	136	MA_Synth Piano02	4/4	2	115			:
Piano	Hip Hop	137	MA_Bklyn	4/4	2	89			:
Piano	Hip Hop	138	MB_Bklyn	4/4	2	89			:
Piano	Hip Hop	139	MC_Bklyn_N	4/4	2	89			:
Piano	Hip Hop	140	MD_Bklyn	4/4	2	89			:
Piano	Hip Hop	141	ME_Bklyn_N	4/4	2	89			:
Piano	Hip Hop	142	MA_HipHopEpic	4/4	2	85			:
Piano	Hip Hop	143	MB_HipHopEpic	4/4	2	85			:
Piano	Hip Hop	144	MA_Hip Reggae_C	4/4	4	92			:
Piano	Hip Hop	145	MB_Hip Reggae_C	4/4	4	92			:
Piano	Hip Hop	146	MC_Hip Reggae_C	4/4	4	92			:
Piano	Hip Hop	147	FA_Hip Reggae_C	4/4	1	92			:
Piano	Hip Hop	148	MA1_ClasticHipHop	4/4	1	90			:
Piano	Hip Hop	149	MB1_ClasticHipHop	4/4	1	90			:
Piano	Modern R&B	150	MA_Synth Piano03	4/4	4	120			:
Piano	Modern R&B	151	MA_Pop Shuffle2_C	4/4	4	94			:
Piano	Modern R&B	152	MB_Pop Shuffle2_C	4/4	4	94			:
Piano	Modern R&B	153	MC_Pop Shuffle2_C	4/4	4	94			:
Piano	Modern R&B	154	FA_Pop Shuffle2_C	4/4	1	94			:
Piano	Modern R&B	155	FB_Pop Shuffle2_C	4/4	1	94			:
Piano	Modern R&B	156	FC_Pop Shuffle2_C	4/4	1	94			:
Piano	Modern R&B	157	BA_Pop Shuffle2_C	4/4	1	94			:
Piano	Modern R&B	158	MA_Pop Shuffle2_N	4/4	4	94			:
Piano	Modern R&B	159	MB_Pop Shuffle2_N	4/4	4	94			:
Piano	Modern R&B	160	MC_Pop Shuffle2_N	4/4	4	94			:
Piano	Modern R&B	161	FA_Pop Shuffle2_N	4/4	1	94			:
Piano	Modern R&B	162	FB_Pop Shuffle2_N	4/4	1	94			:
Piano	Modern R&B	163	FC_Pop Shuffle2_N	4/4	1	94			:
Piano	Modern R&B	164	BA_Pop Shuffle2_N	4/4	1	94			:
Piano	Modern R&B	165	MA_Pop Shuffle3_C	4/4	4	80			:
Piano	Modern R&B	166	MB_Pop Shuffle3_C	4/4	4	80			:
Piano	Modern R&B	167	MC_Pop Shuffle3_C	4/4	4	80			:
Piano	Modern R&B	168	FA_Pop Shuffle3_C	4/4	1	80			:
Piano	Modern R&B	169	FB_Pop Shuffle3_C	4/4	1	80			:
Piano									

Arpeggio Type List

Main Category	Sub Category	ARP No.	ARP Name	Time Signature	Length	Original Tempo	Accent	Random SFX	Sound Type
Piano	Modern R&B	175	FA_Pop Shuffle3_N	4/4	1	80			:
Piano	Modern R&B	176	FB_Pop Shuffle3_N	4/4	1	80			:
Piano	Modern R&B	177	FC_Pop Shuffle3_N	4/4	1	80			:
Piano	Modern R&B	178	BA_Pop Shuffle3_N	4/4	1	80			:
Piano	Modern R&B	179	MA1_6/8 R&B	4/4	2	61			:
Piano	Modern R&B	180	MB1_6/8 R&B	4/4	2	61			:
Piano	Modern R&B	181	MC1_6/8 R&B	4/4	2	61			:
Piano	Modern R&B	182	MD1_6/8 R&B	4/4	2	61			:
Piano	Modern R&B	183	IA1_6/8 R&B	4/4	2	61			:
Piano	Modern R&B	184	FA1_6/8 R&B	4/4	1	61			:
Piano	Modern R&B	185	FB1_6/8 R&B	4/4	1	61			:
Piano	Classic R&B	186	MA_Philly_C	4/4	2	100			:
Piano	Classic R&B	187	MB_Philly_C	4/4	2	100			:
Piano	Classic R&B	188	MC_Philly_C	4/4	2	100			:
Piano	Classic R&B	189	FA_Philly_C	4/4	1	100			:
Piano	Classic R&B	190	FB_Philly_C	4/4	1	100			:
Piano	Classic R&B	191	FC_Philly_C	4/4	1	100			:
Piano	Classic R&B	192	BA_Philly_C	4/4	1	100			:
Piano	Classic R&B	193	EA_Philly_C	4/4	4	100			:
Piano	Classic R&B	194	EB_Philly_C	4/4	3	100			:
Piano	Classic R&B	195	MA_Soul2_N	4/4	2	120			:
Piano	Classic R&B	196	MB_Soul2_N	4/4	1	120			:
Piano	Classic R&B	197	MC_Soul2_N	4/4	4	120			:
Piano	Classic R&B	198	MD_Soul2_N	4/4	4	120			:
Piano	Classic R&B	199	FC_Soul2_N	4/4	4	120			:
Piano	Classic R&B	200	MA_Frankly Soul_C	4/4	4	120			:
Piano	Classic R&B	201	MB_Frankly Soul_C	4/4	4	120			:
Piano	Classic R&B	202	MC_Frankly Soul_C	4/4	4	120			:
Piano	Classic R&B	203	FA_Frankly Soul_C	4/4	1	120			:
Piano	Classic R&B	204	FB_Frankly Soul_C	4/4	1	120			:
Piano	Classic R&B	205	FC_Frankly Soul_C	4/4	1	120			:
Piano	Classic R&B	206	BA_Frankly Soul_C	4/4	1	120			:
Piano	Classic R&B	207	EA_Frankly Soul_C	4/4	3	120			:
Piano	Classic R&B	208	EB_Frankly Soul_C	4/4	4	120			:
Piano	Classic R&B	209	MA_Soul Beat_C	4/4	4	124			:
Piano	Classic R&B	210	MB_Soul Beat_C	4/4	4	124			:
Piano	Classic R&B	211	MC_Soul Beat_C	4/4	4	124			:
Piano	Classic R&B	212	FA_Soul Beat_C	4/4	1	124			:
Piano	Classic R&B	213	FB_Soul Beat_C	4/4	1	124			:
Piano	Classic R&B	214	FC_Soul Beat_C	4/4	1	124			:
Piano	Classic R&B	215	BA_Soul Beat_C	4/4	1	124			:
Piano	Classic R&B	216	EA_Soul Beat_C	4/4	3	123			:
Piano	Classic R&B	217	EB_Soul Beat_C	4/4	3	123			:
Piano	Classic R&B	218	MA_Soul Swing_C	4/4	4	124			:
Piano	Classic R&B	219	MB_Soul Swing_C	4/4	4	124			:
Piano	Classic R&B	220	MC_Soul Swing_C	4/4	4	124			:
Piano	Classic R&B	221	FA_Soul Swing_C	4/4	1	124			:
Piano	Classic R&B	222	FB_Soul Swing_C	4/4	1	124			:
Piano	Classic R&B	223	FC_Soul Swing_C	4/4	1	124			:
Piano	Classic R&B	224	BA_Soul Swing_C	4/4	1	124			:
Piano	Classic R&B	225	EA_Soul Swing_C	4/4	3	123			:
Piano	Classic R&B	226	EB_Soul Swing_C	4/4	5	123			:
Piano	Classic R&B	227	MA_GospelBrothr_C	4/4	4	108			:
Piano	Classic R&B	228	MB_GospelBrothr_C	4/4	4	108			:
Piano	Classic R&B	229	MC_GospelBrothr_C	4/4	4	108			:
Piano	Classic R&B	230	FA_GospelBrothr_C	4/4	1	108			:
Piano	Classic R&B	231	FB_GospelBrothr_C	4/4	1	108			:
Piano	Classic R&B	232	FC_GospelBrothr_C	4/4	1	108			:
Piano	Classic R&B	233	BA_GospelBrothr_C	4/4	1	108			:
Piano	Classic R&B	234	EA_GospelBrothr_C	4/4	4	108			:
Piano	Classic R&B	235	EB_GospelBrothr_C	4/4	3	108			:
Piano	Funk	236	MA_Club Jazz 1_C	4/4	4	125			:
Piano	Funk	237	MB_Club Jazz 1_C	4/4	4	125			:
Piano	Funk	238	MC_Club Jazz 1_C	4/4	4	125			:
Piano	Funk	239	FA_Club Jazz 1_C	4/4	1	125			:
Piano	Funk	240	FB_Club Jazz 1_C	4/4	1	125			:
Piano	Funk	241	FC_Club Jazz 1_C	4/4	1	125			:
Piano	Funk	242	BA_Club Jazz 1_C	4/4	1	125			:
Piano	Funk	243	MA_Club Jazz 1_N	4/4	4	125			:
Piano	Funk	244	MB_Club Jazz 1_N	4/4	4	125			:
Piano	Funk	245	MC_Club Jazz 1_N	4/4	4	125			:
Piano	Funk	246	FA_Club Jazz 1_N	4/4	1	125			:
Piano	Funk	247	FB_Club Jazz 1_N	4/4	1	125			:
Piano	Funk	248	FC_Club Jazz 1_N	4/4	1	125			:
Piano	Funk	249	BA_Club Jazz 1_N	4/4	1	125			:
Piano	Funk	250	MA_Club Jazz 2_C	4/4	4	92			:
Piano	Funk	251	MB_Club Jazz 2_C	4/4	4	92			:
Piano	Funk	252	MC_Club Jazz 2_C	4/4	4	92			:
Piano	Funk	253	FA_Club Jazz 2_C	4/4	1	92			:
Piano	Funk	254	FB_Club Jazz 2_C	4/4	1	92			:
Piano	Funk	255	FC_Club Jazz 2_C	4/4	1	92			:
Piano	Funk	256	BA_Club Jazz 2_C	4/4	1	92			:
Piano	Funk	257	MA_Club Jazz 2_N	4/4	4	92			:
Piano	Funk	258	MB_Club Jazz 2_N	4/4	4	92			:
Piano	Funk	259	MC_Club Jazz 2_N	4/4	4	92			:
Piano	Funk	260	FA_Club Jazz 2_N	4/4	1	92			:
Piano	Funk	261	FB_Club Jazz 2_N	4/4	1	92			:

Main Category	Sub Category	ARP No.	ARP Name	Time Signature	Length	Original Tempo	Accent	Random SFX	Sound Type
Piano	Funk	262	FC_Club Jazz 2_N	4/4	1	92			:
Piano	Funk	263	BA_Club Jazz 2_N	4/4	1	92			:
Piano	Funk	264	MA_Gospel Funk_C	4/4	4	106			:
Piano	Funk	265	MB_Gospel Funk_C	4/4	4	106			:
Piano	Funk	266	MC_Gospel Funk_C	4/4	4	106			:
Piano	Funk	267	FA_Gospel Funk_C	4/4	1	106			:
Piano	Funk	268	FB_Gospel Funk_C	4/4	1	106			:
Piano	Funk	269	FC_Gospel Funk_C	4/4	1	106			:
Piano	Funk	270	BA_Gospel Funk_C	4/4	1	106			:
Piano	Funk	271	EA_Gospel Funk_C	4/4	4	106			:
Piano	Funk	272	EB_Gospel Funk_C	4/4	3	106			:
Piano	Funk	273	MA_70sDiscoFunk_C	4/4	4	112			:
Piano	Funk	274	MB_70sDiscoFunk_C	4/4	4	112			:
Piano	Funk	275	MC_70sDiscoFunk_C	4/4	4	112			:
Piano	Funk	276	FA_70sDiscoFunk_C	4/4	1	112			:
Piano	Funk	277	FB_70sDiscoFunk_C	4/4	1	112			:
Piano	Funk	278	FC_70sDiscoFunk_C	4/4	1	112			:
Piano	Funk	279	BA_70sDiscoFunk_C	4/4	1	112			:
Piano	Funk	280	EA_70sDiscoFunk_C	4/4	4	112			:
Piano	Funk	281	EB_70sDiscoFunk_C	4/4	3	112			:
Piano	House	282	MA_Synth Piano04_N	4/4	2	128			:
Piano	House	283	MA_Synth Piano04	4/4	2	128			:
Piano	House	284	MA_Synth Piano05_N	4/4	2	128			:
Piano	House	285	MA_Synth Piano05	4/4	2	128			:
Piano	House	286	MA_Synth Piano06_N	4/4	4	128			:
Piano	House	287	MA_Synth Piano06	4/4	4	128			:
Piano	House	288	MA_Synth Piano07_N	4/4	2	128			:
Piano	House	289	MA_Synth Piano07	4/4	2	128			:
Piano	House	290	MA_Synth Piano08_N	4/4	2	128			:
Piano	House	291	MA_Synth Piano08	4/4	2	128			:
Piano	House	292	MA_House P11	4/4	2	130			:
Piano	House	293	MA_House P12	4/4	1	130			:
Piano	House	294	MA_House P13	4/4	1	130			:
Piano	House	295	MA_House P14	4/4	1	130			:
Piano	House	296	MA_House P15	4/4	1	130			:
Piano	House	297	MA_DA House	4/4	2	120			:
Piano	Chill	298	MA_EDM BldKeys_N	4/4	4	120			:
Piano	Jazz	299	MA_AcousticJazz_N	4/4	4	204			:
Piano	Jazz	300	MB_AcousticJazz_N	4/4	4	204			:
Piano	Jazz	301	MC_AcousticJazz_N	4/4	4	204			:
Piano	Jazz	302	MD_AcousticJazz_N	4/4	4	204			:
Piano	Jazz	303	FA_AcousticJazz_N	4/4	1	204			:
Piano	Jazz	304	MA_JazzWaltzMed_C	3/4	8	180			:
Piano	Jazz	305	MB_JazzWaltzMed_C	3/4	8	180			:
Piano	Jazz	306	MC_JazzWaltzMed_C	3/4	8	180			:
Piano	Jazz	307	FA_JazzWaltzMed_C	3/4	1	180			:
Piano	Jazz	308	FB_JazzWaltzMed_C	3/4	1	180			:
Piano	Jazz	309	FC_JazzWaltzMed_C	3/4	1	180			:
Piano	Jazz	310	BA_JazzWaltzMed_C	3/4	1	180			:
Piano	Jazz	311	EA_JazzWaltzMed_C	3/4	7	180			:
Piano	Jazz	312	MA_R&R Shuffle_C	4/4	4	192			:
Piano	Jazz	313	MB_R&R Shuffle_C	4/4	4	192			:
Piano	Jazz	314	MC_R&R Shuffle_C	4/4	4	192			:
Piano	Jazz	315	FA_R&R Shuffle_C	4/4	1	192			:
Piano	Jazz	316	FB_R&R Shuffle_C	4/4	1	192			:
Piano	Jazz	317	FC_R&R Shuffle_C	4/4	1	192			:
Piano	Jazz	318	BA_R&R Shuffle_C	4/4	1	192			:
Piano	Jazz	319	EA_R&R Shuffle_C	4/4	5	192			:
Piano	Jazz	320	EB_R&R Shuffle_C	4/4	5	192			:
Piano	Jazz	321	MA_ShuffleBlues_C	4/4	4	115			:
Piano	Jazz	322	MB_ShuffleBlues_C	4/4	4	115			:
Piano	Jazz	323	MC_ShuffleBlues_C	4/4	4	115			:
Piano	Jazz	324	FA_ShuffleBlues_C	4/4	1	115			:
Piano	Jazz	325	FB_ShuffleBlues_C	4/4	1	115			:
Piano	Jazz	326	FC_ShuffleBlues_C	4/4	1	115			:
Piano	Jazz	327	BA_ShuffleBlues_C	4/4	1	115			:
Piano	Jazz	328	EA_ShuffleBlues_C	4/4	5	115			:
Piano	Jazz	329	EB_ShuffleBlues_C	4/4	6	115			:
Piano	Jazz	330	MA_Slow Blues 1_C	4/4	2	49			:
Piano	Jazz	331	MB_Slow Blues 1_C	4/4	2	49			:
Piano	Jazz	332	MC_Slow Blues 1_C	4/4	2	49			:
Piano	Jazz	333	FA_Slow Blues 1_C	4/4	1	49			:
Piano	Jazz	334	FB_Slow Blues 1_C	4/4	1	49			:
Piano	Jazz	335	FC_Slow Blues 1_C	4/4	1	49			:
Piano	Jazz	336	BA_Slow Blues 1_C	4/4	1	49			:
Piano	Jazz	337	EA_Slow Blues 1_C	4/4	3	49			:
Piano	Jazz	338	EB_Slow Blues 1_C	4/4	3	49			:
Piano	Jazz	339	MA_Piano Boogie_C	4/4	8	160			:
Piano	Jazz	340	MB_Piano Boogie_C	4/4	4	160			:
Piano	Jazz	341	MC_Piano Boogie_C	4/4	4	160			:
Piano	Jazz	342	FA_Piano Boogie_C	4/4	1	160			:
Piano	Jazz	343							

Arpeggio Type List

Main Category	Sub Category	ARP No.	ARP Name	Time Signature	Length	Original Tempo	Accent	Random SFX	Sound Type
Piano	Latin	349	MB_Salsa 1_C	4/4	4	177			:
Piano	Latin	350	MC_Salsa 1_C	4/4	4	177			:
Piano	Latin	351	FA_Salsa 1_C	4/4	1	177			:
Piano	Latin	352	FB_Salsa 1_C	4/4	1	177			:
Piano	Latin	353	FC_Salsa 1_C	4/4	1	177			:
Piano	Latin	354	BA_Salsa 1_C	4/4	1	177			:
Piano	Latin	355	EA_Salsa 1_C	4/4	5	177			:
Piano	Latin	356	EB_Salsa 1_C	4/4	5	177			:
Piano	Latin	357	MA_Salsa 2_N	4/4	1	123			:
Piano	Latin	358	MB_Salsa 2_N	4/4	1	123			:
Piano	Latin	359	MC_Salsa 2	4/4	2	123			:
Piano	Latin	360	MD_Salsa 2_N	4/4	4	123			:
Piano	Latin	361	FC_Salsa 2	4/4	2	123			:
Piano	Latin	362	MA_AfroCuban_C	4/4	4	200			:
Piano	Latin	363	MB_AfroCuban_C	4/4	4	200			:
Piano	Latin	364	MC_AfroCuban_C	4/4	4	200			:
Piano	Latin	365	FA_AfroCuban_C	4/4	1	200			:
Piano	Latin	366	FB_AfroCuban_C	4/4	1	200			:
Piano	Latin	367	FC_AfroCuban_C	4/4	1	200			:
Piano	Latin	368	BA_AfroCuban_C	4/4	1	200			:
Piano	Latin	369	EA_AfroCuban_C	4/4	6	200			:
Piano	Latin	370	EB_AfroCuban_C	4/4	5	200			:
Piano	Latin	371	MA_Montuno_N	4/4	1	100			:
Piano	Latin	372	MC_Montuno_N	4/4	2	100			:
Piano	Latin	373	MD_Montuno_N	4/4	2	100			:
Piano	Latin	374	FA_Montuno_N	4/4	1	100			:
Piano	Latin	375	FC_Montuno_N	4/4	1	100			:
Piano	Latin	376	MA_Samba	4/4	1	120			:
Piano	Latin	377	MB_Samba	4/4	4	120			:
Piano	Latin	378	MC_Samba	4/4	4	120			:
Piano	Latin	379	MA_Bomba_C	4/4	4	99			:
Piano	Latin	380	MB_Bomba_C	4/4	4	99			:
Piano	Latin	381	MC_Bomba_C	4/4	4	99			:
Piano	Latin	382	FA_Bomba_C	4/4	1	99			:
Piano	Latin	383	FB_Bomba_C	4/4	1	99			:
Piano	Latin	384	FC_Bomba_C	4/4	1	99			:
Piano	Latin	385	BA_Bomba_C	4/4	1	99			:
Piano	Latin	386	EA_Bomba_C	4/4	3	99			:
Piano	Latin	387	EB_Bomba_C	4/4	3	99			:
Piano	Latin	388	MA_Merengue_C	4/4	4	130			:
Piano	Latin	389	MB_Merengue_C	4/4	4	130			:
Piano	Latin	390	MC_Merengue_C	4/4	4	130			:
Piano	Latin	391	FA_Merengue_C	4/4	1	130			:
Piano	Latin	392	FB_Merengue_C	4/4	1	130			:
Piano	Latin	393	FC_Merengue_C	4/4	1	130			:
Piano	Latin	394	BA_Merengue_C	4/4	1	130			:
Piano	Latin	395	EA_Merengue_C	4/4	3	130			:
Piano	Latin	396	EB_Merengue_C	4/4	3	130			:
Piano	Latin	397	MA_Guaguanco_C	4/4	4	120			:
Piano	Latin	398	MB_Guaguanco_C	4/4	4	120			:
Piano	Latin	399	MC_Guaguanco_C	4/4	4	120			:
Piano	Latin	400	FA_Guaguanco_C	4/4	1	120			:
Piano	Latin	401	FB_Guaguanco_C	4/4	1	120			:
Piano	Latin	402	FC_Guaguanco_C	4/4	1	120			:
Piano	Latin	403	BA_Guaguanco_C	4/4	1	120			:
Piano	Latin	404	EA_Guaguanco_C	4/4	3	120			:
Piano	Latin	405	EB_Guaguanco_C	4/4	3	120			:
Piano	Latin	406	MA1_Latin Rock	4/4	2	120			:
Piano	Latin	407	MD1_Latin Rock	4/4	4	120			:
Piano	Latin	408	FB1_Latin Rock	4/4	1	120			:
Piano	Latin	409	MC2_Latin Rock	4/4	2	120			:
Piano	Latin	410	FA2_Latin Rock	4/4	1	120			:
Piano	Latin	411	MA_Disco Latin_C	4/4	4	100			:
Piano	Latin	412	MB_Disco Latin_C	4/4	4	100			:
Piano	Latin	413	MC_Disco Latin_C	4/4	4	100			:
Piano	Latin	414	FA_Disco Latin_C	4/4	1	100			:
Piano	Latin	415	FB_Disco Latin_C	4/4	1	100			:
Piano	Latin	416	FC_Disco Latin_C	4/4	1	100			:
Piano	Latin	417	BA_Disco Latin_C	4/4	1	100			:
Piano	Latin	418	IA_Latin House_N	4/4	2	138			:
Piano	Latin	419	FA_Latin House_N	4/4	2	138			:
Piano	Latin	420	FC_Latin House_N	4/4	2	138			:
Piano	Latin	421	MA_Piano Latin	4/4	2	120			:
Piano	World	422	MA_Jumbo Reggae_C	4/4	4	100			:
Piano	World	423	MB_Jumbo Reggae_C	4/4	4	100			:
Piano	World	424	MC_Jumbo Reggae_C	4/4	4	100			:
Piano	World	425	FA_Jumbo Reggae_C	4/4	1	100			:
Piano	World	426	FB_Jumbo Reggae_C	4/4	1	100			:
Piano	World	427	FC_Jumbo Reggae_C	4/4	1	100			:
Piano	World	428	BA_Jumbo Reggae_C	4/4	1	100			:
Piano	World	429	EA_Jumbo Reggae_C	4/4	3	100			:
Piano	World	430	EB_Jumbo Reggae_C	4/4	3	100			:
Piano	General	431	MA_Pi Arp1	4/4	2	64			:
Piano	General	432	MA_Pi Arp2	4/4	2	74			:
Piano	General	433	MA_Pi Arp3	4/4	2	124			:
Piano	General	434	MA_Pi Arp4	4/4	2	130			:
Piano	General	435	MA_Pi Arp5	4/4	2	130			:

Main Category	Sub Category	ARP No.	ARP Name	Time Signature	Length	Original Tempo	Accent	Random SFX	Sound Type
Piano	General	436	MA_Pi Arp6	4/4	2	130			:
Piano	General	437	MA_Pi Arp7	4/4	2	130			:
Piano	General	438	MA_Pi Arp8	4/4	2	65			:
Piano	General	439	MA_Pi Arp9	4/4	1	116			:
Piano	General	440	MA_Pi Arp10	4/4	1	96			:
Piano	General	441	MA_Pi Arp11	4/4	1	82			:
Piano	General	442	MA_Pi Arp12	4/4	1	90			:
Piano	General	443	MA_Pi Arp13	4/4	1	90			:
Piano	General	444	MA_Pi Arp14	4/4	1	90			:
Piano	General	445	MA_Pi Arp15	4/4	1	90			:
Piano	General	446	MA_Pi Arp16	4/4	1	90			:
Piano	General	447	MA_Pi Arp17	4/4	1	100			:
Piano	General	448	MA_Pi Arp18	4/4	1	90			:
Piano	General	449	MA_Pi Arp19	4/4	1	84			:
Piano	General	450	MA_Pi Arp20	4/4	1	90			:
Piano	General	451	MA_Pi Arp21	4/4	1	86			:
Piano	General	452	MA_Pi Arp22	4/4	1	90			:
Piano	General	453	MA_Pi Arp23	4/4	1	90			:
Piano	General	454	MA_Pi Arp24	4/4	2	130			:
Piano	General	455	MA_Pi Arp25	4/4	2	130			:
Piano	General	456	MA_Pi Arp26	4/4	2	130			:
Piano	General	457	MA_Pi Arp27	4/4	2	130			:
Piano	General	458	MA_Pi Arp28	4/4	2	120			:
Piano	General	459	MA_Pi Arp29	4/4	1	74			:
Keys	Rock	460	MA_ProgresRock2_C	4/4	4	120			Electric Piano
Keys	Rock	461	MB_ProgresRock2_C	4/4	4	120			:
Keys	Rock	462	MC_ProgresRock2_C	4/4	4	120			:
Keys	Rock	463	FA_ProgresRock2_C	4/4	1	120			:
Keys	Rock	464	FB_ProgresRock2_C	4/4	1	120			:
Keys	Rock	465	FC_ProgresRock2_C	4/4	1	120			:
Keys	Rock	466	BA_ProgresRock2_C	4/4	1	120			:
Keys	Rock	467	MA_ProgresRock2_N	4/4	4	120			:
Keys	Rock	468	MB_ProgresRock2_N	4/4	4	120			:
Keys	Rock	469	MC_ProgresRock2_N	4/4	4	120			:
Keys	Rock	470	FA_ProgresRock2_N	4/4	1	120			:
Keys	Rock	471	FB_ProgresRock2_N	4/4	1	120			:
Keys	Rock	472	FC_ProgresRock2_N	4/4	1	120			:
Keys	Rock	473	BA_ProgresRock2_N	4/4	1	120			:
Keys	Pop Rock	474	MA_There 2 Here_N	4/4	1	135			:
Keys	Pop Rock	475	MA_8Beat Medium_C	4/4	4	105			:
Keys	Pop Rock	476	MB_8Beat Medium_C	4/4	4	105			:
Keys	Pop Rock	477	MC_8Beat Medium_C	4/4	4	105			:
Keys	Pop Rock	478	MD_8Beat Medium_C	4/4	4	105			:
Keys	Pop Rock	479	FA_8Beat Medium_C	4/4	1	105			:
Keys	Pop Rock	480	FB_8Beat Medium_C	4/4	1	105			:
Keys	Pop Rock	481	FC_8Beat Medium_C	4/4	1	105			:
Keys	Pop Rock	482	FD_8Beat Medium_C	4/4	1	105			:
Keys	Pop Rock	483	EA_8Beat Medium_C	4/4	4	105			:
Keys	Pop Rock	484	MA_16Beat Medium_C	4/4	4	96			:
Keys	Pop Rock	485	MB_16Beat Medium_C	4/4	4	96			:
Keys	Pop Rock	486	MC_16Beat Medium_C	4/4	4	96			:
Keys	Pop Rock	487	MD_16Beat Medium_C	4/4	4	96			:
Keys	Pop Rock	488	FA_16Beat Medium_C	4/4	1	96			:
Keys	Pop Rock	489	FB_16Beat Medium_C	4/4	1	96			:
Keys	Pop Rock	490	FC_16Beat Medium_C	4/4	1	96			:
Keys	Pop Rock	491	FD_16Beat Medium_C	4/4	1	96			:
Keys	Pop Rock	492	EA_16Beat Medium_C	4/4	4	96			:
Keys	Pop Rock	493	MA_Country Waltz_C	3/4	4	144			:
Keys	Pop Rock	494	MB_Country Waltz_C	3/4	4	144			:
Keys	Pop Rock	495	MC_Country Waltz_C	3/4	4	144			:
Keys	Pop Rock	496	MD_Country Waltz_C	3/4	4	144			:
Keys	Pop Rock	497	FA_Country Waltz_C	3/4	1	144			:
Keys	Pop Rock	498	FB_Country Waltz_C	3/4	1	144			:
Keys	Pop Rock	499	FC_Country Waltz_C	3/4	1	144			:
Keys	Pop Rock	500	FD_Country Waltz_C	3/4	1	144			:
Keys	Pop Rock	501	EA_Country Waltz_C	3/4	5	144			:
Keys	Pop Rock	502	MA_Cool 8Beat_C	4/4	2	100			:
Keys	Pop Rock	503	MB_Cool 8Beat_C	4/4	2	100			:
Keys	Pop Rock	504	MC_Cool 8Beat_C	4/4	2	100			:
Keys	Pop Rock	505	FA_Cool 8Beat_C	4/4	1	100			:
Keys	Pop Rock	506	FB_Cool 8Beat_C	4/4	1	100			:
Keys	Pop Rock	507	FC_Cool 8Beat_C	4/4	1	100			:
Keys	Pop Rock	508	BA_Cool 8Beat_C	4/4	1	100			:
Keys	Pop Rock	509	EA_Cool 8Beat_C	4/4	4	100			:
Keys	Pop Rock	510	EB_Cool 8Beat_C	4/4	4	100			:
Keys	Pop Rock	511	MA_8Beat Basic_C	4/4	4	120			:
Keys	Pop Rock	512	MB_8Beat Basic_C	4/4	4	120			:
Keys	Pop Rock	513	MC_8Beat Basic_C	4/4	4	120			:
Keys	Pop Rock	514	FA_8Beat Basic_C	4/4	1	120			:
Keys	Pop Rock	515	FB_8Beat Basic_C	4/4	1	120			:
Keys	Pop Rock	516	FC_8Beat Basic_C	4/4	1	120			:
Keys	Pop Rock	517	BA_8Beat Basic_C	4/4	1	120			:
Keys	Pop Rock	518	MA_8Beat Basic_N	4/4	4	120			:
Keys	Pop Rock	519	MB_8Beat Basic_N	4/4	4	120			:
Keys	Pop Rock	520	MC_8Beat Basic_N	4/4	4	120			:
Keys	Pop Rock	521	FA_8Beat Basic						

Arpeggio Type List

Main Category	Sub Category	ARP No.	ARP Name	Time Signature	Length	Original Tempo	Accent	Random SFX	Sound Type
Keys	Pop Rock	523	FC_8Beat Basic_N	4/4	1	120			:
Keys	Pop Rock	524	BA_8Beat Basic_N	4/4	1	120			:
Keys	Pop Rock	525	MA_16BeatBasic1_C	4/4	4	90			:
Keys	Pop Rock	526	MB_16BeatBasic1_C	4/4	4	90			:
Keys	Pop Rock	527	MC_16BeatBasic1_C	4/4	4	90			:
Keys	Pop Rock	528	FA_16BeatBasic1_C	4/4	1	90			:
Keys	Pop Rock	529	FB_16BeatBasic1_C	4/4	1	90			:
Keys	Pop Rock	530	FC_16BeatBasic1_C	4/4	1	90			:
Keys	Pop Rock	531	BA_16BeatBasic1_C	4/4	1	90			:
Keys	Pop Rock	532	MA_16BeatBasic1_N	4/4	4	90			:
Keys	Pop Rock	533	MB_16BeatBasic1_N	4/4	4	90			:
Keys	Pop Rock	534	MC_16BeatBasic1_N	4/4	4	90			:
Keys	Pop Rock	535	FA_16BeatBasic1_N	4/4	1	90			:
Keys	Pop Rock	536	FB_16BeatBasic1_N	4/4	1	90			:
Keys	Pop Rock	537	FC_16BeatBasic1_N	4/4	1	90			:
Keys	Pop Rock	538	BA_16BeatBasic1_N	4/4	1	90			:
Keys	Pop Rock	539	MA_16BeatBasic2_C	4/4	4	77			:
Keys	Pop Rock	540	MB_16BeatBasic2_C	4/4	4	77			:
Keys	Pop Rock	541	MC_16BeatBasic2_C	4/4	4	77			:
Keys	Pop Rock	542	FA_16BeatBasic2_C	4/4	1	77			:
Keys	Pop Rock	543	FB_16BeatBasic2_C	4/4	1	77			:
Keys	Pop Rock	544	FC_16BeatBasic2_C	4/4	1	77			:
Keys	Pop Rock	545	BA_16BeatBasic2_C	4/4	1	77			:
Keys	Pop Rock	546	MA_16BeatBasic2_N	4/4	4	77			:
Keys	Pop Rock	547	MB_16BeatBasic2_N	4/4	4	77			:
Keys	Pop Rock	548	MC_16BeatBasic2_N	4/4	4	77			:
Keys	Pop Rock	549	FA_16BeatBasic2_N	4/4	1	77			:
Keys	Pop Rock	550	FB_16BeatBasic2_N	4/4	1	77			:
Keys	Pop Rock	551	FC_16BeatBasic2_N	4/4	1	77			:
Keys	Pop Rock	552	BA_16BeatBasic2_N	4/4	1	77			:
Keys	Pop Rock	553	MA_16Beat Pop 1_C	4/4	4	103			:
Keys	Pop Rock	554	MB_16Beat Pop 1_C	4/4	4	103			:
Keys	Pop Rock	555	MC_16Beat Pop 1_C	4/4	4	103			:
Keys	Pop Rock	556	FA_16Beat Pop 1_C	4/4	1	103			:
Keys	Pop Rock	557	FB_16Beat Pop 1_C	4/4	1	103			:
Keys	Pop Rock	558	FC_16Beat Pop 1_C	4/4	1	103			:
Keys	Pop Rock	559	BA_16Beat Pop 1_C	4/4	1	103			:
Keys	Pop Rock	560	MA_16Beat Pop 1_N	4/4	4	103			:
Keys	Pop Rock	561	MB_16Beat Pop 1_N	4/4	4	103			:
Keys	Pop Rock	562	MC_16Beat Pop 1_N	4/4	4	103			:
Keys	Pop Rock	563	FA_16Beat Pop 1_N	4/4	1	103			:
Keys	Pop Rock	564	FB_16Beat Pop 1_N	4/4	1	103			:
Keys	Pop Rock	565	FC_16Beat Pop 1_N	4/4	1	103			:
Keys	Pop Rock	566	BA_16Beat Pop 1_N	4/4	1	103			:
Keys	Pop Rock	567	MB1_Analog Pop	4/4	2	93			:
Keys	Pop Rock	568	MC2_Analog Pop	4/4	2	93			:
Keys	Pop Rock	569	IA2_Analog Pop	4/4	1	93			:
Keys	Pop Rock	570	MA_6/8 Pop_C	4/4	4	100			:
Keys	Pop Rock	571	MB_6/8 Pop_C	4/4	4	100			:
Keys	Pop Rock	572	MC_6/8 Pop_C	4/4	4	100			:
Keys	Pop Rock	573	FA_6/8 Pop_C	4/4	1	100			:
Keys	Pop Rock	574	FB_6/8 Pop_C	4/4	1	100			:
Keys	Pop Rock	575	FC_6/8 Pop_C	4/4	1	100			:
Keys	Pop Rock	576	BA_6/8 Pop_C	4/4	1	100			:
Keys	Pop Rock	577	MA_6/8 Pop_N	4/4	4	100			:
Keys	Pop Rock	578	MB_6/8 Pop_N	4/4	4	100			:
Keys	Pop Rock	579	MC_6/8 Pop_N	4/4	4	100			:
Keys	Pop Rock	580	FA_6/8 Pop_N	4/4	1	100			:
Keys	Pop Rock	581	FB_6/8 Pop_N	4/4	1	100			:
Keys	Pop Rock	582	FC_6/8 Pop_N	4/4	1	100			:
Keys	Pop Rock	583	BA_6/8 Pop_N	4/4	1	100			:
Keys	Ballad	584	MA_16Bt Ballad1_C	4/4	4	59			:
Keys	Ballad	585	MB_16Bt Ballad1_C	4/4	4	59			:
Keys	Ballad	586	MC_16Bt Ballad1_C	4/4	4	59			:
Keys	Ballad	587	MD_16Bt Ballad1_C	4/4	4	59			:
Keys	Ballad	588	FA_16Bt Ballad1_C	4/4	1	59			:
Keys	Ballad	589	FB_16Bt Ballad1_C	4/4	1	59			:
Keys	Ballad	590	FC_16Bt Ballad1_C	4/4	1	59			:
Keys	Ballad	591	FD_16Bt Ballad1_C	4/4	1	59			:
Keys	Ballad	592	EA_16Bt Ballad1_C	4/4	3	59			:
Keys	Ballad	593	MA_Eclectic Bld_C	4/4	4	84			:
Keys	Ballad	594	MB_Eclectic Bld_C	4/4	4	84			:
Keys	Ballad	595	MC_Eclectic Bld_C	4/4	4	84			:
Keys	Ballad	596	MD_Eclectic Bld_C	4/4	4	84			:
Keys	Ballad	597	FA_Eclectic Bld_C	4/4	1	84			:
Keys	Ballad	598	FB_Eclectic Bld_C	4/4	1	84			:
Keys	Ballad	599	FC_Eclectic Bld_C	4/4	1	84			:
Keys	Ballad	600	FD_Eclectic Bld_C	4/4	1	84			:
Keys	Ballad	601	EA_Eclectic Bld_C	4/4	4	84			:
Keys	Ballad	602	MA_EP Ballad_C	4/4	2	60			:
Keys	Ballad	603	MB_EP Ballad_C	4/4	2	60			:
Keys	Ballad	604	MC_EP Ballad_C	4/4	2	60			:
Keys	Ballad	605	FA_EP Ballad_C	4/4	1	60			:
Keys	Ballad	606	FB_EP Ballad_C	4/4	1	60			:
Keys	Ballad	607	FC_EP Ballad_C	4/4	1	60			:
Keys	Ballad	608	BA_EP Ballad_C	4/4	1	60			:
Keys	Ballad	609	EA_EP Ballad_C	4/4	4	60			:

Main Category	Sub Category	ARP No.	ARP Name	Time Signature	Length	Original Tempo	Accent	Random SFX	Sound Type
Keys	Ballad	610	EB_EP Ballad_C	4/4	4	60			:
Keys	Ballad	611	MA2_8Beat Slow_C	4/4	4	78			:
Keys	Ballad	612	MB2_8Beat Slow_C	4/4	4	78			:
Keys	Ballad	613	MC2_8Beat Slow_C	4/4	4	78			:
Keys	Ballad	614	FA2_8Beat Slow_C	4/4	1	78			:
Keys	Ballad	615	FB2_8Beat Slow_C	4/4	1	78			:
Keys	Ballad	616	FC2_8Beat Slow_C	4/4	1	78			:
Keys	Ballad	617	BA2_8Beat Slow_C	4/4	1	78			:
Keys	Ballad	618	MA2_8Beat Slow_N	4/4	4	78			:
Keys	Ballad	619	MB2_8Beat Slow_N	4/4	4	78			:
Keys	Ballad	620	MC2_8Beat Slow_N	4/4	4	78			:
Keys	Ballad	621	FA2_8Beat Slow_N	4/4	1	78			:
Keys	Ballad	622	FB2_8Beat Slow_N	4/4	1	78			:
Keys	Ballad	623	FC2_8Beat Slow_N	4/4	1	78			:
Keys	Ballad	624	BA2_8Beat Slow_N	4/4	1	78			:
Keys	Ballad	625	MA_8Beat Soft_C	4/4	4	100			:
Keys	Ballad	626	MB_8Beat Soft_C	4/4	4	100			:
Keys	Ballad	627	MC_8Beat Soft_C	4/4	4	100			:
Keys	Ballad	628	FA_8Beat Soft_C	4/4	1	100			:
Keys	Ballad	629	FB_8Beat Soft_C	4/4	1	100			:
Keys	Ballad	630	FC_8Beat Soft_C	4/4	1	100			:
Keys	Ballad	631	BA_8Beat Soft_C	4/4	1	100			:
Keys	Ballad	632	MA_8Beat Soft_N	4/4	4	100			:
Keys	Ballad	633	MB_8Beat Soft_N	4/4	4	100			:
Keys	Ballad	634	MC_8Beat Soft_N	4/4	4	100			:
Keys	Ballad	635	FA_8Beat Soft_N	4/4	1	100			:
Keys	Ballad	636	FB_8Beat Soft_N	4/4	1	100			:
Keys	Ballad	637	FC_8Beat Soft_N	4/4	1	100			:
Keys	Ballad	638	BA_8Beat Soft_N	4/4	1	100			:
Keys	Ballad	639	MA_Slowfeel	4/4	1	74			:
Keys	Ballad	640	MB_Slowfeel	4/4	1	74			:
Keys	Ballad	641	MC_Slowfeel	4/4	1	74			:
Keys	Ballad	642	MD_Slowfeel	4/4	1	74			:
Keys	Ballad	643	FA_Slowfeel	4/4	1	74			:
Keys	Ballad	644	FB_Slowfeel	4/4	1	74			:
Keys	Ballad	645	MA_16Bt Ballad2_C	4/4	4	75			:
Keys	Ballad	646	MB_16Bt Ballad2_C	4/4	4	75			:
Keys	Ballad	647	MC_16Bt Ballad2_C	4/4	4	75			:
Keys	Ballad	648	FA_16Bt Ballad2_C	4/4	1	75			:
Keys	Ballad	649	FB_16Bt Ballad2_C	4/4	1	75			:
Keys	Ballad	650	FC_16Bt Ballad2_C	4/4	1	75			:
Keys	Ballad	651	BA_16Bt Ballad2_C	4/4	1	75			:
Keys	Ballad	652	MA_16Bt Ballad2_N	4/4	4	75			:
Keys	Ballad	653	MB_16Bt Ballad2_N	4/4	4	75			:
Keys	Ballad	654	MC_16Bt Ballad2_N	4/4	4	75			:
Keys	Ballad	655	FA_16Bt Ballad2_N	4/4	1	75			:
Keys	Ballad	656	FB_16Bt Ballad2_N	4/4	1	75			:
Keys	Ballad	657	FC_16Bt Ballad2_N	4/4	1	75			:
Keys	Ballad	658	BA_16Bt Ballad2_N	4/4	1	75			:
Keys	Hip Hop	659	MA_Synth Piano09	4/4	2	120			:
Keys	Hip Hop	660	MA_New Hip Hop_C	4/4	2	85			:
Keys	Hip Hop	661	MB_New Hip Hop_C	4/4	2	85			:
Keys	Hip Hop	662	MC_New Hip Hop_C	4/4	2	85			:
Keys	Hip Hop	663	FA_New Hip Hop_C	4/4	1	85			:
Keys	Hip Hop	664	FB_New Hip Hop_C	4/4	1	85			:
Keys	Hip Hop	665	FC_New Hip Hop_C	4/4	1	85			:
Keys	Hip Hop	666	BA_New Hip Hop_C	4/4	1	85			:
Keys	Hip Hop	667	EA_New Hip Hop_C	4/4	3	85			:
Keys	Hip Hop	668	EB_New Hip Hop_C	4/4	3	85			:
Keys	Hip Hop	669	MA1_Hip Hop 1_N	4/4	2	105			:
Keys	Hip Hop	670	MB1_Hip Hop 1_N	4/4	2	105			:
Keys	Hip Hop	671	MC1_Hip Hop 1_N	4/4	2	105			:
Keys	Hip Hop	672	FA1_Hip Hop 1_N	4/4	1	105			:
Keys	Hip Hop	673	MA2_Hip Hop 1_N	4/4	2	105			:
Keys	Hip Hop	674	MB2_Hip Hop 1_N	4/4	2	105			Harpischord
Keys	Hip Hop	675	MC2_Hip Hop 1_N	4/4	2	105			:
Keys	Hip Hop	676	FB2_Hip Hop 1_N	4/4	1	105			:
Keys	Hip Hop	677	FC_Hip Hop 2	4/4	2	94			Electric Piano
Keys	Hip Hop	678	IA2_ClasichipHop_N	4/4	2	90			:
Keys	Modern R&B	679	MA_Neo UK Soul_C	4/4	4	79			:
Keys	Modern R&B	680	MB_Neo UK Soul_C	4/4	4	79			:
Keys	Modern R&B	681	MC_Neo UK Soul_C	4/4	4	79			:
Keys	Modern R&B	682	MD_Neo UK Soul_C	4/4	4	79			:
Keys	Modern R&B	683	FA_Neo UK Soul_C	4/4	1	79			:
Keys	Modern R&B	684	FB_Neo UK Soul_C	4/4	1	79			:
Keys	Modern R&B	685	FC_Neo UK Soul_C	4/4	1	79			:
Keys	Modern R&B	686	FD_Neo UK Soul_C	4/4	1	79			:
Keys	Modern R&B	687	EA_Neo UK Soul_C	4/4	3	79			:
Keys	Modern R&B	688	MA_Slow & Easy_C	4/4	4	72			:
Keys	Modern R&B	689	MB_Slow & Easy_C	4/4	4	72			:
Keys	Modern R&B	690	MC_Slow & Easy_C	4/4	4	72			:

Arpeggio Type List

Main Category	Sub Category	ARP No.	ARP Name	Time Signature	Length	Original Tempo	Accent	Random SFX	Sound Type
Keys	Modern R&B	697	MA_R&B Disco	4/4	2	110			:
Keys	Modern R&B	698	MD_R&B Disco	4/4	2	110			:
Keys	Modern R&B	699	FB_R&B Disco	4/4	1	110			:
Keys	Modern R&B	700	FC_R&B Disco	4/4	2	110			:
Keys	Modern R&B	701	MA_ChartPop1_C	4/4	4	92			:
Keys	Modern R&B	702	MB_ChartPop1_C	4/4	4	92			:
Keys	Modern R&B	703	MC_ChartPop1_C	4/4	4	92			:
Keys	Modern R&B	704	FA_ChartPop1_C	4/4	1	92			:
Keys	Modern R&B	705	FB_ChartPop1_C	4/4	1	92			:
Keys	Modern R&B	706	FC_ChartPop1_C	4/4	1	92			:
Keys	Modern R&B	707	BA_ChartPop1_C	4/4	1	92			:
Keys	Modern R&B	708	EA_ChartPop1_C	4/4	3	92			:
Keys	Modern R&B	709	EB_ChartPop1_C	4/4	3	92			:
Keys	Modern R&B	710	MA_H-R&B Pop_C	4/4	4	140			:
Keys	Modern R&B	711	MB_H-R&B Pop_C	4/4	4	140			:
Keys	Modern R&B	712	MC_H-R&B Pop_C	4/4	4	140			:
Keys	Modern R&B	713	FA_H-R&B Pop_C	4/4	1	140			:
Keys	Modern R&B	714	FB_H-R&B Pop_C	4/4	1	140			:
Keys	Modern R&B	715	FC_H-R&B Pop_C	4/4	1	140			:
Keys	Modern R&B	716	BA_H-R&B Pop_C	4/4	1	140			:
Keys	Modern R&B	717	MA_J-R&B Pop_C	4/4	4	100			:
Keys	Modern R&B	718	MB_J-R&B Pop_C	4/4	4	100			:
Keys	Modern R&B	719	MC_J-R&B Pop_C	4/4	4	100			:
Keys	Modern R&B	720	FA_J-R&B Pop_C	4/4	1	100			:
Keys	Modern R&B	721	FB_J-R&B Pop_C	4/4	1	100			:
Keys	Modern R&B	722	FC_J-R&B Pop_C	4/4	1	100			:
Keys	Modern R&B	723	MA_R&B Ballad 1_C	4/4	4	70			:
Keys	Modern R&B	724	MB_R&B Ballad 1_C	4/4	4	70			:
Keys	Modern R&B	725	MC_R&B Ballad 1_C	4/4	4	70			:
Keys	Modern R&B	726	FA_R&B Ballad 1_C	4/4	1	70			:
Keys	Modern R&B	727	FB_R&B Ballad 1_C	4/4	1	70			:
Keys	Modern R&B	728	FC_R&B Ballad 1_C	4/4	1	70			:
Keys	Modern R&B	729	BA_R&B Ballad 1_C	4/4	1	70			:
Keys	Modern R&B	730	MA_R&B Ballad 3_C	4/4	4	113			:
Keys	Modern R&B	731	MB_R&B Ballad 3_C	4/4	4	113			:
Keys	Modern R&B	732	MC_R&B Ballad 3_C	4/4	4	113			:
Keys	Modern R&B	733	FA_R&B Ballad 3_C	4/4	1	113			:
Keys	Modern R&B	734	FB_R&B Ballad 3_C	4/4	1	113			:
Keys	Modern R&B	735	FC_R&B Ballad 3_C	4/4	1	113			:
Keys	Modern R&B	736	MA_Ballad EP1	4/4	2	74			:
Keys	Modern R&B	737	MA_Ballad EP2	4/4	2	74			:
Keys	Modern R&B	738	MA_Ballad EP3	4/4	2	74			:
Keys	Modern R&B	739	MA_Swing EP	4/4	1	101			:
Keys	Modern R&B	740	MA_EP Chords	4/4	2	101			:
Keys	Modern R&B	741	MA2_6/8 R&B	4/4	2	61			:
Keys	Modern R&B	742	MB2_6/8 R&B	4/4	2	61			:
Keys	Modern R&B	743	MC2_6/8 R&B	4/4	2	61			:
Keys	Modern R&B	744	MD2_6/8 R&B	4/4	2	61			:
Keys	Modern R&B	745	IA2_6/8 R&B	4/4	2	61			:
Keys	Modern R&B	746	FA2_6/8 R&B_N	4/4	1	61			:
Keys	Modern R&B	747	FB2_6/8 R&B_N	4/4	1	61			:
Keys	Modern R&B	748	MB_Smooth 1	4/4	2	115			:
Keys	Modern R&B	749	MC_Smooth 1	4/4	2	115			:
Keys	Modern R&B	750	MA_New Gospel	4/4	2	90			:
Keys	Modern R&B	751	MB_New Gospel	4/4	2	90			:
Keys	Modern R&B	752	MC_New Gospel	4/4	2	90			:
Keys	Modern R&B	753	MD_New Gospel	4/4	2	90			:
Keys	Modern R&B	754	FA_New Gospel	4/4	1	90			:
Keys	Modern R&B	755	FC_New Gospel	4/4	2	90			:
Keys	Modern R&B	756	MA_Synth Piano10	4/4	4	97			:
Keys	Classic R&B	757	MA_Soul Shuffle_C	4/4	4	98			:
Keys	Classic R&B	758	MB_Soul Shuffle_C	4/4	4	98			:
Keys	Classic R&B	759	MC_Soul Shuffle_C	4/4	4	98			:
Keys	Classic R&B	760	FA_Soul Shuffle_C	4/4	1	98			:
Keys	Classic R&B	761	FB_Soul Shuffle_C	4/4	1	98			:
Keys	Classic R&B	762	FC_Soul Shuffle_C	4/4	1	98			:
Keys	Classic R&B	763	BA_Soul Shuffle_C	4/4	1	98			:
Keys	Classic R&B	764	EA_Soul Shuffle_C	4/4	3	98			:
Keys	Classic R&B	765	EB_Soul Shuffle_C	4/4	3	98			:
Keys	Funk	766	MA_Funk 1_C	4/4	8	104			:
Keys	Funk	767	MB_Funk 1_C	4/4	8	104			:
Keys	Funk	768	MC_Funk 1_C	4/4	8	104			:
Keys	Funk	769	FA_Funk 1_C	4/4	1	104			:
Keys	Funk	770	FB_Funk 1_C	4/4	1	104			:
Keys	Funk	771	FC_Funk 1_C	4/4	1	104			:
Keys	Funk	772	BA_Funk 1_C	4/4	1	104			:
Keys	Funk	773	EA_Funk 1_C	4/4	9	104			:
Keys	Funk	774	EB_Funk 1_C	4/4	4	104			:
Keys	Funk	775	MD_Cool Funk	4/4	2	96			:
Keys	Funk	776	IA_Cool Funk	4/4	2	96			:
Keys	Funk	777	FA_Cool Funk	4/4	1	96			:
Keys	Funk	778	FB_Cool Funk	4/4	1	96			:
Keys	Funk	779	MA_Jazz Pop_C	4/4	2	102			:
Keys	Funk	780	MB_Jazz Pop_C	4/4	2	102			:
Keys	Funk	781	MC_Jazz Pop_C	4/4	2	102			:
Keys	Funk	782	FA_Jazz Pop_C	4/4	1	102			:
Keys	Funk	783	FB_Jazz Pop_C	4/4	1	102			:

Main Category	Sub Category	ARP No.	ARP Name	Time Signature	Length	Original Tempo	Accent	Random SFX	Sound Type
Keys	Funk	784	FC_Jazz Pop_C	4/4	1	102			:
Keys	Funk	785	BA_Jazz Pop_C	4/4	1	102			:
Keys	Funk	786	MA_Funk Disco_C	4/4	2	126			:
Keys	Funk	787	MB_Funk Disco_C	4/4	2	126			:
Keys	Funk	788	MC_Funk Disco_C	4/4	2	126			:
Keys	Funk	789	FA_Funk Disco_C	4/4	1	126			:
Keys	Funk	790	FB_Funk Disco_C	4/4	1	126			:
Keys	Funk	791	FC_Funk Disco_C	4/4	1	126			:
Keys	Funk	792	BA_Funk Disco_C	4/4	1	126			:
Keys	Funk	793	EA_Funk Disco_C	4/4	4	126			:
Keys	Funk	794	EB_Funk Disco_C	4/4	3	126			:
Keys	Funk	795	MA_Clavi1	4/4	1	110			Clavi
Keys	Funk	796	MA_Clavi2	4/4	1	110			:
Keys	Funk	797	MA_Clavi3	4/4	1	110			:
Keys	Funk	798	MA_Clavi4	4/4	1	124			:
Keys	Funk	799	MA_Clavi5	4/4	1	124			:
Keys	Funk	800	MA_Clavi6	4/4	1	124			:
Keys	Funk	801	MA_Clavi7	4/4	1	124			:
Keys	Funk	802	MA_Super Clavi	4/4	4	101			:
Keys	Funk	803	MA_Touch Clavi	4/4	1	101			:
Keys	House	804	MA_Synth Piano11_N	4/4	2	128			Electric Piano
Keys	House	805	MA_Synth Piano11	4/4	2	128			:
Keys	House	806	MA_Synth Piano12_N	4/4	4	120			:
Keys	House	807	MA_Synth Piano12	4/4	4	120			:
Keys	House	808	MA_Synth Piano13_N	4/4	2	128			:
Keys	House	809	MA_Synth Piano13	4/4	2	128			:
Keys	House	810	MA_Synth Piano14_N	4/4	2	128			:
Keys	House	811	MA_Synth Piano14	4/4	2	128			:
Keys	House	812	MA_Synth Piano15_N	4/4	2	128			:
Keys	House	813	MA_Synth Piano15	4/4	2	128			:
Keys	House	814	MA_Epoque Keys	4/4	2	122			:
Keys	House	815	MA_Rodeo Keys	4/4	2	120			:
Keys	House	816	MA_Disco House_C	4/4	4	126			:
Keys	House	817	MB_Disco House_C	4/4	4	126			:
Keys	House	818	MC_Disco House_C	4/4	4	126			:
Keys	House	819	FA_Disco House_C	4/4	1	126			:
Keys	House	820	FB_Disco House_C	4/4	1	126			:
Keys	House	821	FC_Disco House_C	4/4	1	126			:
Keys	House	822	BA_Disco House_C	4/4	1	126			:
Keys	House	823	MD_Club House	4/4	1	128			:
Keys	House	824	FC_Club House_N	4/4	2	128			:
Keys	House	825	MA_Garage 2	4/4	2	127			:
Keys	House	826	MA_Deep House1_N	4/4	1	127			:
Keys	House	827	MA_Deep House2_N	4/4	1	130			:
Keys	House	828	MA_Deep House3_N	4/4	1	127			:
Keys	House	829	MA_Deep House4_N	4/4	2	130			:
Keys	House	830	MA_Syn Clavi	4/4	1	126			Clavi
Keys	Chill	831	MA_Vintage Chill_N	4/4	4	130			Electric Piano
Keys	Chill	832	MA_Vintage Chill	4/4	4	130			:
Keys	Chill	833	MA_Ambient 3_N	4/4	4	88			:
Keys	Chill	834	MB_Ambient 3_N	4/4	4	88			:
Keys	Chill	835	MC_Ambient 3_N	4/4	4	88			:
Keys	Chill	836	FA_Ambient 3_N	4/4	1	88			:
Keys	Chill	837	FB_Ambient 3_N	4/4	1	88			:
Keys	Chill	838	FC_Ambient 3_N	4/4	1	88			:
Keys	Chill	839	BA_Ambient 3_N	4/4	1	88			:
Keys	World	840	MB1_Reggae 2	4/4	2	92			:
Keys	World	841	MD1_Reggae 2	4/4	2	92			:
Keys	World	842	FA1_Reggae 2	4/4	1	92			:
Keys	World	843	FB1_Reggae 2	4/4	1	92			:
Keys	World	844	MA2_Reggae 2	4/4	2	92			Clavi
Keys	World	845	MB2_Reggae 2	4/4	2	92			:
Keys	World	846	MD2_Reggae 2	4/4	2	92			:
Keys	World	847	IA2_Reggae 2	4/4	2	92			:
Keys	World	848	FA2_Reggae 2	4/4	1	92			:
Keys	World	849	MA_Saedy 1_C	4/4	2	120			:
Keys	World	850	MB_Saedy 1_C	4/4	2	120			:
Keys	World	851	MC_Saedy 1_C	4/4	4	120			:
Keys	World	852	FA_Saedy 1_C	4/4	1	120			:
Keys	World	853	FB_Saedy 1_C	4/4	1	120			:
Keys	World	854	FC_Saedy 1_C	4/4	1	120			:
Keys	World	855	BA_Saedy 1_C	4/4	1	120			:
Keys	World	856	EA_Saedy 1_C	4/4	4	120			:
Keys	General	857	MA_Baroque_C	4/4	4	88			Harpischord
Keys	General	858	MB_Baroque_C	4/4	4	88			:
Keys	General	859	MC_Baroque_C	4/4	4	88			:
Keys	General	860	MD_Baroque_C	4/4	4	88			:
Keys	General	861	FA_Baroque_C	4/4	1	88			:
Keys	General	862	FB_Baroque_C	4/4	1	88			:
Keys	General	863	FC_Baroque_C	4/4	1	88			:
Keys	General	864	FD_Baroque_C	4/4	1	88			:
Organ	Rock	865	MA_ProgresRock1_C	4/4	4				

Arpeggio Type List

Main Category	Sub Category	ARP No.	ARP Name	Time Signature	Length	Original Tempo	Accent	Random SFX	Sound Type
Organ	Rock	871	BA_ProgresRock1_C	4/4	1	110			:
Organ	Rock	872	MA_ProgresRock1_N	4/4	4	110			:
Organ	Rock	873	MB_ProgresRock1_N	4/4	3	110			:
Organ	Rock	874	MC_ProgresRock1_N	4/4	4	110			:
Organ	Rock	875	FA_ProgresRock1_N	4/4	1	110			:
Organ	Rock	876	FB_ProgresRock1_N	4/4	1	110			:
Organ	Rock	877	FC_ProgresRock1_N	4/4	1	110			:
Organ	Rock	878	BA_ProgresRock1_N	4/4	1	110			:
Organ	Ballad	879	MA_6/8 Ballad_C	6/8	4	87			:
Organ	Ballad	880	MB_6/8 Ballad_C	6/8	4	87			:
Organ	Ballad	881	MC_6/8 Ballad_C	6/8	4	87			:
Organ	Ballad	882	FA_6/8 Ballad_C	6/8	1	87			:
Organ	Ballad	883	FB_6/8 Ballad_C	6/8	1	87			:
Organ	Ballad	884	FC_6/8 Ballad_C	6/8	1	87			:
Organ	Ballad	885	BA_6/8 Ballad_C	6/8	1	87			:
Organ	Ballad	886	MA_6/8 Ballad_N	6/8	4	87			:
Organ	Ballad	887	MB_6/8 Ballad_N	6/8	4	87			:
Organ	Ballad	888	MC_6/8 Ballad_N	6/8	4	87			:
Organ	Ballad	889	FA_6/8 Ballad_N	6/8	1	87			:
Organ	Ballad	890	FB_6/8 Ballad_N	6/8	1	87			:
Organ	Ballad	891	FC_6/8 Ballad_N	6/8	1	87			:
Organ	Ballad	892	BA_6/8 Ballad_N	6/8	1	87			:
Organ	Hip Hop	893	MD_Hip Hop 1_N	4/4	2	105			:
Organ	Hip Hop	894	FC_Hip Hop 1_N	4/4	2	105			:
Organ	Classic R&B	895	MA_Soul 1_C	4/4	2	116			:
Organ	Classic R&B	896	MB_Soul 1_C	4/4	2	116			:
Organ	Classic R&B	897	MC_Soul 1_C	4/4	2	116			:
Organ	Classic R&B	898	FA_Soul 1_C	4/4	1	116			:
Organ	Classic R&B	899	FB_Soul 1_C	4/4	1	116			:
Organ	Classic R&B	900	FC_Soul 1_C	4/4	1	116			:
Organ	Classic R&B	901	BA_Soul 1_C	4/4	1	116			:
Organ	Classic R&B	902	EA_Soul 1_C	4/4	4	116			:
Organ	Classic R&B	903	EB_Soul 1_C	4/4	3	116			:
Organ	Classic R&B	904	MA_Soul 2	4/4	1	120			:
Organ	Classic R&B	905	MB_Soul 2	4/4	4	120			:
Organ	Classic R&B	906	FB_Soul 2_N	4/4	1	120			:
Organ	Funk	907	MA_Jazz Funk 1_C	4/4	4	120			:
Organ	Funk	908	MB_Jazz Funk 1_C	4/4	4	120			:
Organ	Funk	909	MC_Jazz Funk 1_C	4/4	4	120			:
Organ	Funk	910	FA_Jazz Funk 1_C	4/4	1	120			:
Organ	Funk	911	FB_Jazz Funk 1_C	4/4	1	120			:
Organ	Funk	912	FC_Jazz Funk 1_C	4/4	1	120			:
Organ	Funk	913	BA_Jazz Funk 1_C	4/4	1	120			:
Organ	Funk	914	EA_Jazz Funk 1_C	4/4	3	120			:
Organ	Funk	915	EB_Jazz Funk 1_C	4/4	3	120			:
Organ	Funk	916	MB_Jazz Funk 2	4/4	4	120			:
Organ	Funk	917	MA_Funk Organ1	4/4	2	110			:
Organ	Funk	918	MA_Funk Organ2	4/4	2	110			:
Organ	House	919	MA_Dance Organ01_N	4/4	4	135			:
Organ	House	920	MA_Dance Organ01	4/4	4	135			:
Organ	House	921	MA_Dance Organ02_N	4/4	4	135			:
Organ	House	922	MA_Dance Organ02	4/4	4	135			:
Organ	House	923	MA_Dance Organ03_N	4/4	4	135			:
Organ	House	924	MA_Dance Organ03	4/4	4	135			:
Organ	House	925	MA_Dance Organ04_N	4/4	4	135			:
Organ	House	926	MA_Dance Organ04	4/4	4	135			:
Organ	House	927	MA_Dance Organ05_N	4/4	4	135			:
Organ	House	928	MA_Dance Organ05	4/4	4	135			:
Organ	House	929	MA_Dance Organ06_N	4/4	2	135			:
Organ	House	930	MA_Dance Organ06	4/4	2	135			:
Organ	House	931	MA_Dance Organ07_N	4/4	4	135			:
Organ	House	932	MA_Dance Organ07	4/4	4	135			:
Organ	House	933	MA_Dance Organ08_N	4/4	4	135			:
Organ	House	934	MA_Dance Organ08	4/4	4	135			:
Organ	House	935	MA_Dance Organ09_N	4/4	2	135			:
Organ	House	936	MA_Dance Organ09	4/4	2	135			:
Organ	House	937	MA_Dance Organ10_N	4/4	4	135			:
Organ	House	938	MA_Dance Organ10	4/4	4	135			:
Organ	House	939	MA_House Organ1	4/4	1	130			:
Organ	House	940	MA_House Organ2	4/4	1	130			:
Organ	House	941	MA_House Organ3	4/4	1	130			:
Organ	House	942	MA_House Organ4	4/4	1	130			:
Organ	House	943	MA_House Organ5	4/4	2	126			:
Organ	Jazz	944	MA_Slow Blues 2_C	4/4	4	72			:
Organ	Jazz	945	MB_Slow Blues 2_C	4/4	4	72			:
Organ	Jazz	946	MC_Slow Blues 2_C	4/4	4	72			:
Organ	Jazz	947	FA_Slow Blues 2_C	4/4	1	72			:
Organ	Jazz	948	FB_Slow Blues 2_C	4/4	1	72			:
Organ	Jazz	949	FC_Slow Blues 2_C	4/4	1	72			:
Organ	Jazz	950	BA_Slow Blues 2_C	4/4	1	72			:
Organ	Jazz	951	MA_Slow Blues 2_N	4/4	4	72			:
Organ	Jazz	952	MB_Slow Blues 2_N	4/4	4	72			:
Organ	Jazz	953	MC_Slow Blues 2_N	4/4	4	72			:
Organ	Jazz	954	FA_Slow Blues 2_N	4/4	1	72			:
Organ	Jazz	955	FB_Slow Blues 2_N	4/4	1	72			:
Organ	Jazz	956	FC_Slow Blues 2_N	4/4	1	72			:
Organ	Jazz	957	BA_Slow Blues 2_N	4/4	1	72			:

Main Category	Sub Category	ARP No.	ARP Name	Time Signature	Length	Original Tempo	Accent	Random SFX	Sound Type
Organ	Latin	958	MA_Latin Rock	4/4	2	120			:
Organ	Latin	959	MB_Latin Rock	4/4	2	120			:
Organ	Latin	960	MA_Latin Organ	4/4	1	110			:
Organ	World	961	MA_Reggae 1	4/4	4	102			:
Organ	World	962	MB_Reggae 1	4/4	4	102			:
Organ	World	963	MD_Reggae 1	4/4	4	90			:
Organ	World	964	FB_Reggae 1	4/4	1	102			:
Organ	World	965	MA_Reggae 2	4/4	1	92			:
Organ	World	966	MB_Reggae 2	4/4	2	92			:
Organ	World	967	MC_Reggae 2	4/4	2	92			:
Organ	World	968	MD_Reggae 2	4/4	1	92			:
Organ	World	969	IA_Reggae 2	4/4	2	92			:
Organ	World	970	FB_Reggae 2	4/4	1	92			:
Organ	World	971	MA_ReggaeOrgan1	4/4	2	120			:
Organ	World	972	MA_ReggaeOrgan2	4/4	1	120			:
Gtr	Rock	973	MA_OverdriveG1	4/4	4	120			Od/Dist Guitar
Gtr	Rock	974	MA_OverdriveG12_N	4/4	4	120			:
Gtr	Rock	975	MA_OverdriveG13_N	4/4	4	120			:
Gtr	Rock	976	MA_OverdriveG14_N	4/4	4	120			:
Gtr	Rock	977	MA_OverdriveG15_N	4/4	4	120			:
Gtr	Rock	978	MA_Guitar Over1	1/4	4	180			:
Gtr	Rock	979	MA_Guitar Over2	1/4	4	120			:
Gtr	Rock	980	MA_ContempRock_C	4/4	4	126			:
Gtr	Rock	981	MB_ContempRock_C	4/4	4	126			:
Gtr	Rock	982	MC_ContempRock_C	4/4	4	126			:
Gtr	Rock	983	FA_ContempRock_C	4/4	1	126			:
Gtr	Rock	984	FB_ContempRock_C	4/4	1	126			:
Gtr	Rock	985	FC_ContempRock_C	4/4	1	126			:
Gtr	Rock	986	BA_ContempRock_C	4/4	1	126			:
Gtr	Rock	987	EA_ContempRock_C	4/4	4	126			:
Gtr	Rock	988	EB_ContempRock_C	4/4	4	126			:
Gtr	Rock	989	MA1_70s Rock	4/4	2	130			Clean Guitar
Gtr	Rock	990	MB1_70s Rock	4/4	2	130			:
Gtr	Rock	991	MC1_70s Rock	4/4	4	130			:
Gtr	Rock	992	MD1_70s Rock_N	4/4	2	130			:
Gtr	Rock	993	MB2_70s Rock_N	4/4	4	130			Od/Dist Guitar
Gtr	Rock	994	MC2_70s Rock_N	4/4	2	130			:
Gtr	Rock	995	MD2_70s Rock_N	4/4	2	130			:
Gtr	Rock	996	FC2_70s Rock_N	4/4	2	130			:
Gtr	Rock	997	MA3_70s Rock_N	4/4	2	130			:
Gtr	Rock	998	MB3_70s Rock_N	4/4	2	130			:
Gtr	Rock	999	MC3_70s Rock_N	4/4	1	130			:
Gtr	Rock	1000	MD3_70s Rock_N	4/4	4	130			:
Gtr	Rock	1001	MA_OverTheTop1	4/4	2	120			Over The Top
Gtr	Rock	1002	MA_OverTheTop2	4/4	2	120			:
Gtr	Rock	1003	MA_OverTheTop3	4/4	2	120			:
Gtr	Rock	1004	MA_OverTheTop4	4/4	4	120			:
Gtr	Rock	1005	MA_OverTheTop5	4/4	4	120			:
Gtr	Rock	1006	MA_AlternaRock1_N	4/4	4	97			Od/Dist Guitar
Gtr	Rock	1007	MB_AlternaRock1_N	4/4	4	97			:
Gtr	Rock	1008	MC_AlternaRock1_N	4/4	4	97			:
Gtr	Rock	1009	FA_AlternaRock1_N	4/4	1	97			:
Gtr	Rock	1010	FB_AlternaRock1_N	4/4	1	97			:
Gtr	Rock	1011	FC_AlternaRock1_N	4/4	1	97			:
Gtr	Rock	1012	BA_AlternaRock1_N	4/4	1	97			:
Gtr	Rock	1013	MA_AlternaRock2_N	4/4	4	100			:
Gtr	Rock	1014	MB_AlternaRock2_N	4/4	4	100			:
Gtr	Rock	1015	MC_AlternaRock2_N	4/4	4	100			:
Gtr	Rock	1016	FA_AlternaRock2_N	4/4	1	100			:
Gtr	Rock	1017	FB_AlternaRock2_N	4/4	1	100			:
Gtr	Rock	1018	FC_AlternaRock2_N	4/4	1	100			:
Gtr	Rock	1019	BA_AlternaRock2_N	4/4	2	100			:
Gtr	Rock	1020	MC1_Xover Rock_N	4/4	2	100			:
Gtr	Rock	1021	MD1_Xover Rock_N	4/4	2	100			:
Gtr	Rock	1022	FB1_Xover Rock_N	4/4	1	100			:
Gtr	Rock	1023	FC1_Xover Rock_N	4/4	2	100			:
Gtr	Rock	1024	MA2_Xover Rock_N	4/4	2	100			:
Gtr	Rock	1025	MB2_Xover Rock_N	4/4	1	100			:
Gtr	Rock	1026	IA2_Xover Rock_N	4/4	2	100			Clean Guitar
Gtr	Rock	1027	FA2_Xover Rock_N	4/4	1	100			:
Gtr	Rock	1028	MA1_8Beat Rock_C	4/4	4	75			:
Gtr	Rock	1029	MB1_8Beat Rock_C	4/4	4	75			:
Gtr	Rock	1030	MC1_8Beat Rock_C	4/4	4	75			:
Gtr	Rock	1031	FA1_8Beat Rock_C	4/4	1	75			:
Gtr	Rock	1032	FB1_8Beat Rock_C	4/4	1	75			:
Gtr	Rock	1033	FC1_8Beat Rock_C	4/4	1	75			:
Gtr	Rock	1034	BA1_8Beat Rock_C	4/4	1	75			:
Gtr	Rock	1035	MA1_8Beat Rock_N	4/4	4	75			:
Gtr	Rock	1036	MB1_8Beat Rock_N	4/4	4	75			:
Gtr	Rock	1037	MC1_8Beat Rock_N	4/4	4	75			:
Gtr	Rock	1038	FA1_8Beat Rock_N	4/4	1	75			:
Gtr	Rock	1039	FB1_8Beat Rock_N	4/4	1	75			:
Gtr	Rock	1040	FC1_8Beat Rock_N	4/4	1	75			:
Gtr	Rock	1041							

Main Category	Sub Category	ARP No.	ARP Name	Time Signature	Length	Original Tempo	Accent	Random SFX	Sound Type
Gtr	Rock	1045	FA2_8Beat Rock_C	4/4	1	75			:
Gtr	Rock	1046	FB2_8Beat Rock_C	4/4	1	75			:
Gtr	Rock	1047	FC2_8Beat Rock_C	4/4	1	75			:
Gtr	Rock	1048	BA2_8Beat Rock_C	4/4	1	75			:
Gtr	Rock	1049	MA2_8Beat Rock_N	4/4	4	75			:
Gtr	Rock	1050	MB2_8Beat Rock_N	4/4	4	75			:
Gtr	Rock	1051	MC2_8Beat Rock_N	4/4	4	75			:
Gtr	Rock	1052	FA2_8Beat Rock_N	4/4	1	75			:
Gtr	Rock	1053	FB2_8Beat Rock_N	4/4	1	75			:
Gtr	Rock	1054	FC2_8Beat Rock_N	4/4	1	75			:
Gtr	Rock	1055	BA2_8Beat Rock_N	4/4	1	75			:
Gtr	Rock	1056	MA_16Beat Rock_C	4/4	4	86			Over The Top
Gtr	Rock	1057	MB_16Beat Rock_C	4/4	4	86			:
Gtr	Rock	1058	MC_16Beat Rock_C	4/4	4	86			:
Gtr	Rock	1059	FA_16Beat Rock_C	4/4	1	86			:
Gtr	Rock	1060	FB_16Beat Rock_C	4/4	1	86			:
Gtr	Rock	1061	FC_16Beat Rock_C	4/4	1	86			:
Gtr	Rock	1062	BA_16Beat Rock_C	4/4	1	86			:
Gtr	Rock	1063	MA_16Beat Rock	4/4	4	86			:
Gtr	Rock	1064	MB_16Beat Rock	4/4	4	86			:
Gtr	Rock	1065	MC_16Beat Rock	4/4	4	86			:
Gtr	Rock	1066	FA_16Beat Rock	4/4	1	86			:
Gtr	Rock	1067	FB_16Beat Rock	4/4	1	86			:
Gtr	Rock	1068	FC_16Beat Rock	4/4	1	86			:
Gtr	Rock	1069	BA_16Beat Rock	4/4	1	86			:
Gtr	Rock	1070	MA_ProgresRock1_C	4/4	4	110			DriveWah (2handGtr)
Gtr	Rock	1071	MB_ProgresRock1_C	4/4	3	110			:
Gtr	Rock	1072	MC_ProgresRock1_C	4/4	4	110			:
Gtr	Rock	1073	FA_ProgresRock1_C	4/4	1	110			:
Gtr	Rock	1074	FB_ProgresRock1_C	4/4	1	110			:
Gtr	Rock	1075	FC_ProgresRock1_C	4/4	1	110			:
Gtr	Rock	1076	BA_ProgresRock1_C	4/4	1	110			:
Gtr	Rock	1077	MA_ProgresRock1_N	4/4	4	110			:
Gtr	Rock	1078	MB_ProgresRock1_N	4/4	3	110			:
Gtr	Rock	1079	MC_ProgresRock1	4/4	4	110			:
Gtr	Rock	1080	FA_ProgresRock1_N	4/4	1	110			:
Gtr	Rock	1081	FB_ProgresRock1	4/4	1	110			:
Gtr	Rock	1082	FC_ProgresRock1	4/4	1	110			:
Gtr	Rock	1083	BA_ProgresRock1	4/4	1	110			:
Gtr	Rock	1084	MA_ProgresRock2_C	4/4	4	120			Clean Guitar
Gtr	Rock	1085	MB_ProgresRock2_C	4/4	4	120			:
Gtr	Rock	1086	MC_ProgresRock2_C	4/4	4	120			:
Gtr	Rock	1087	FA_ProgresRock2_C	4/4	1	120			:
Gtr	Rock	1088	FB_ProgresRock2_C	4/4	1	120			:
Gtr	Rock	1089	FC_ProgresRock2_C	4/4	1	120			:
Gtr	Rock	1090	BA_ProgresRock2_C	4/4	1	120			:
Gtr	Rock	1091	MA_ProgresRock2	4/4	4	120			:
Gtr	Rock	1092	MB_ProgresRock2_N	4/4	4	120			:
Gtr	Rock	1093	MC_ProgresRock2_N	4/4	4	120			:
Gtr	Rock	1094	FA_ProgresRock2_N	4/4	1	120			:
Gtr	Rock	1095	FB_ProgresRock2_N	4/4	1	120			:
Gtr	Rock	1096	FC_ProgresRock2_N	4/4	1	120			:
Gtr	Rock	1097	BA_ProgresRock2_N	4/4	1	120			:
Gtr	Rock	1098	MA_Rock Guitar1	4/4	1	120			Od/Dist Guitar
Gtr	Rock	1099	MA_Rock Guitar2	4/4	1	120			:
Gtr	Rock	1100	MA_Rock Guitar3	4/4	1	120			:
Gtr	Pop Rock	1101	MA_Guitar Pop 1_C	4/4	4	100			Acoustic Guitar
Gtr	Pop Rock	1102	MB_Guitar Pop 1_C	4/4	4	100			:
Gtr	Pop Rock	1103	MC_Guitar Pop 1_C	4/4	4	100			:
Gtr	Pop Rock	1104	FA_Guitar Pop 1_C	4/4	1	100			:
Gtr	Pop Rock	1105	FB_Guitar Pop 1_C	4/4	1	100			:
Gtr	Pop Rock	1106	FC_Guitar Pop 1_C	4/4	1	100			:
Gtr	Pop Rock	1107	BA_Guitar Pop 1_C	4/4	1	100			:
Gtr	Pop Rock	1108	EA_Guitar Pop 1_C	4/4	3	100			:
Gtr	Pop Rock	1109	EB_Guitar Pop 1_C	4/4	3	100			:
Gtr	Pop Rock	1110	MA1_Guitar Pop 2	4/4	2	90			:
Gtr	Pop Rock	1111	MA1_Guitar Pop2 AF2	4/4	2	90			Aco Guitar / Syn Pad
Gtr	Pop Rock	1112	MB1_Guitar Pop 2	4/4	1	90			Acoustic Guitar
Gtr	Pop Rock	1113	MC1_Guitar Pop 2	4/4	2	90			:
Gtr	Pop Rock	1114	IA1_Guitar Pop 2	4/4	1	90			:
Gtr	Pop Rock	1115	MA2_Guitar Pop 2	4/4	1	90			:
Gtr	Pop Rock	1116	IA2_Guitar Pop 2	4/4	1	90			Clean Guitar
Gtr	Pop Rock	1117	MA1_FingerPickin_N	4/4	2	120			Acoustic Guitar
Gtr	Pop Rock	1118	MB1_FingerPickin_N	4/4	2	120			:
Gtr	Pop Rock	1119	MC1_FingerPickin_N	4/4	2	120			:
Gtr	Pop Rock	1120	MD1_FingerPickin_N	4/4	3	120			:
Gtr	Pop Rock	1121	IA1_FingerPickin	4/4	1	120			:
Gtr	Pop Rock	1122	FA1_FingerPickin_N	4/4	1	120			:
Gtr	Pop Rock	1123	FB1_FingerPickin_N	4/4	1	120			:
Gtr	Pop Rock	1124	MA2_FingerPickin	4/4	2	120			:
Gtr	Pop Rock	1125	MB2_FingerPickin	4/4	2	120			:
Gtr	Pop Rock	1126	MC2_FingerPickin	4/4	2	120			:
Gtr	Pop Rock	1127	MD2_FingerPickin	4/4	2	120			:
Gtr	Pop Rock	1128	IA2_FingerPickin	4/4	2	120			:
Gtr	Pop Rock	1129	FA2_FingerPickin	4/4	1	120			:
Gtr	Pop Rock	1130	FB2_FingerPickin	4/4	1	120			:
Gtr	Pop Rock	1131	MA_Pickin1	4/4	3	120			:

Main Category	Sub Category	ARP No.	ARP Name	Time Signature	Length	Original Tempo	Accent	Random SFX	Sound Type
Gtr	Pop Rock	1132	MA_Pickin2	4/4	2	120			:
Gtr	Pop Rock	1133	MA_Pickin3	4/4	2	120			:
Gtr	Pop Rock	1134	MA1_Folk Rock_N	4/4	2	120			:
Gtr	Pop Rock	1135	MB1_Folk Rock_N	4/4	2	120			:
Gtr	Pop Rock	1136	IA1_Folk Rock_N	4/4	1	120			:
Gtr	Pop Rock	1137	IA1_FolkRock AF1_N	4/4	1	80			:
Gtr	Pop Rock	1138	IA1_FolkRk AF1&2_N	4/4	1	80			:
Gtr	Pop Rock	1139	MA2_Folk Rock	4/4	2	120			:
Gtr	Pop Rock	1140	MB2_Folk Rock	4/4	2	120			:
Gtr	Pop Rock	1141	MC2_Folk Rock	4/4	2	120			:
Gtr	Pop Rock	1142	IA2_Folk Rock	4/4	1	120			:
Gtr	Pop Rock	1143	IA2_FolkRk AF1	4/4	1	80			:
Gtr	Pop Rock	1144	MC3_Folk Rock_N	4/4	2	120			Clean Guitar
Gtr	Pop Rock	1145	MD3_Folk Rock_N	4/4	2	120			:
Gtr	Pop Rock	1146	FA3_Folk Rock_N	4/4	1	120			:
Gtr	Pop Rock	1147	MA_12 GuitarA1_N	4/4	4	120			Acoustic Guitar
Gtr	Pop Rock	1148	MA_12 GuitarA2_N	4/4	4	120			:
Gtr	Pop Rock	1149	MA_12 GuitarA3_N	4/4	4	120			:
Gtr	Pop Rock	1150	MA_12 GuitarA4_N	4/4	4	120			:
Gtr	Pop Rock	1151	MA_12 GuitarA5_N	4/4	4	120			:
Gtr	Pop Rock	1152	MA_12 GuitarB1	4/4	1	97			:
Gtr	Pop Rock	1153	MA_12 GuitarB2	4/4	1	100			:
Gtr	Pop Rock	1154	MA_Worship Fast_C	4/4	8	114			:
Gtr	Pop Rock	1155	MB_Worship Fast_C	4/4	4	114			:
Gtr	Pop Rock	1156	MC_Worship Fast_C	4/4	4	114			:
Gtr	Pop Rock	1157	FA_Worship Fast_C	4/4	1	114			:
Gtr	Pop Rock	1158	FB_Worship Fast_C	4/4	1	114			:
Gtr	Pop Rock	1159	FC_Worship Fast_C	4/4	1	114			:
Gtr	Pop Rock	1160	BA_Worship Fast_C	4/4	1	114			:
Gtr	Pop Rock	1161	EA_Worship Fast_C	4/4	4	114			:
Gtr	Pop Rock	1162	EB_Worship Fast_C	4/4	2	114			:
Gtr	Pop Rock	1163	MA_New Country_C	4/4	2	118			:
Gtr	Pop Rock	1164	MB_New Country_C	4/4	4	118			:
Gtr	Pop Rock	1165	MC_New Country_C	4/4	2	118			:
Gtr	Pop Rock	1166	FA_New Country_C	4/4	1	118			:
Gtr	Pop Rock	1167	FB_New Country_C	4/4	1	118			:
Gtr	Pop Rock	1168	FC_New Country_C	4/4	1	118			:
Gtr	Pop Rock	1169	BA_New Country_C	4/4	1	118			:
Gtr	Pop Rock	1170	EA_New Country_C	4/4	4	118			:
Gtr	Pop Rock	1171	EB_New Country_C	4/4	4	118			:
Gtr	Pop Rock	1172	MA_New Country_C	4/4	2	118			:
Gtr	Pop Rock	1173	MB_New Country_C	4/4	4	118			:
Gtr	Pop Rock	1174	MC_New Country_C	4/4	2	118			:
Gtr	Pop Rock	1175	FA_New Country_C	4/4	1	118			:
Gtr	Pop Rock	1176	FB_New Country_C	4/4	1	118			:
Gtr	Pop Rock	1177	FC_New Country_C	4/4	1	118			:
Gtr	Pop Rock	1178	BA_New Country_C	4/4	1	118			:
Gtr	Pop Rock	1179	MA_BritPopSwing_C	4/4	2	110			Clean Guitar
Gtr	Pop Rock	1180	MB_BritPopSwing_C	4/4	2	110			:
Gtr	Pop Rock	1181	MC_BritPopSwing_C	4/4	2	110			:
Gtr	Pop Rock	1182	FA_BritPopSwing_C	4/4	1	110			:
Gtr	Pop Rock	1183	FB_BritPopSwing_C	4/4	1	110			:
Gtr	Pop Rock	1184	FC_BritPopSwing_C	4/4	1	110			:
Gtr	Pop Rock	1185	BA_BritPopSwing_C	4/4	1	110			:
Gtr	Pop Rock	1186	EA_BritPopSwing_C	4/4	4	110			:
Gtr	Pop Rock	1187	EB_BritPopSwing_C	4/4	4	110			:
Gtr	Pop Rock	1188	MA_8Beat Basic_C	4/4	4	120			:
Gtr	Pop Rock	1189	MB_8Beat Basic_C	4/4	4	120			:
Gtr	Pop Rock	1190	MC_8Beat Basic_C	4/4	4	120			:
Gtr	Pop Rock	1191	FA_8Beat Basic_C	4/4	1	120			:
Gtr	Pop Rock	1192	FB_8Beat Basic_C	4/4	1	120			:
Gtr	Pop Rock	1193	FC_8Beat Basic_C	4/4	1	120			:
Gtr	Pop Rock	1194	BA_8Beat Basic_C	4/4	1	120			:
Gtr	Pop Rock	1195	MA_8Beat Basic_N	4/4	4	120			:
Gtr	Pop Rock	1196	MB_8Beat Basic_N	4/4	4	120			:
Gtr	Pop Rock	1197	MC_8Beat Basic_N	4/4	4	120			:
Gtr	Pop Rock	1198	FA_8Beat Basic_N	4/4	1	120			:
Gtr	Pop Rock	1199	FB_8Beat Basic_N	4/4	1	120			:
Gtr	Pop Rock	1200	FC_8Beat Basic_N	4/4	1	120			:
Gtr	Pop Rock	1201	BA_8Beat Basic_N	4/4	1	120			:
Gtr	Pop Rock	1202	MA_8Beat Soft_C	4/4	4	100			Acoustic Guitar
Gtr	Pop Rock	1203	MB_8Beat Soft_C	4/4	4	100			:
Gtr	Pop Rock	1204	MC_8Beat Soft_C	4/4	4	100			:
Gtr	Pop Rock	1205	FA_8Beat Soft_C	4/4	1	100			:
Gtr	Pop Rock	1206	FB_8Beat Soft_C	4/4	1	100			:
Gtr	Pop Rock	1207	FC_8Beat Soft_C	4/4	1	100			:
Gtr	Pop Rock	1208	BA_8Beat Soft_C	4/4	1	100			:
Gtr	Pop Rock	1209	MA_8Beat Soft_N	4/4	4	100			:
Gtr	Pop Rock	1210	MB_8Beat Soft_N	4/4	4	100			:
Gtr	Pop Rock	1211	MC_8Beat Soft_N	4/4	4	100			:
Gtr	Pop Rock	1212	FA_8Beat Soft_N	4/4	1	100			

Arpeggio Type List

Main Category	Sub Category	ARP No.	ARP Name	Time Signature	Length	Original Tempo	Accent	Random SFX	Sound Type
Gtr	Pop Rock	1219	MD1_Soft Rock	4/4	2	120			:
Gtr	Pop Rock	1220	IA1_Soft Rock	4/4	1	120			:
Gtr	Pop Rock	1221	FA1_Soft Rock_N	4/4	1	120			:
Gtr	Pop Rock	1222	FB1_Soft Rock	4/4	1	120			:
Gtr	Pop Rock	1223	MD2_Soft Rock_N	4/4	2	120			Od/Dist Guitar
Gtr	Pop Rock	1224	FB2_Soft Rock_N	4/4	1	120			:
Gtr	Pop Rock	1225	MA_16BeatBasic1_C	4/4	4	90			Clean Guitar
Gtr	Pop Rock	1226	MB_16BeatBasic1_C	4/4	4	90			:
Gtr	Pop Rock	1227	MC_16BeatBasic1_C	4/4	4	90			:
Gtr	Pop Rock	1228	FA_16BeatBasic1_C	4/4	1	90			:
Gtr	Pop Rock	1229	FB_16BeatBasic1_C	4/4	1	90			:
Gtr	Pop Rock	1230	FC_16BeatBasic1_C	4/4	1	90			:
Gtr	Pop Rock	1231	BA_16BeatBasic1_C	4/4	1	90			:
Gtr	Pop Rock	1232	MA_16BeatBasic1_N	4/4	4	90			:
Gtr	Pop Rock	1233	MB_16BeatBasic1_N	4/4	4	90			:
Gtr	Pop Rock	1234	MC_16BeatBasic1_N	4/4	4	90			:
Gtr	Pop Rock	1235	FA_16BeatBasic1_N	4/4	1	90			:
Gtr	Pop Rock	1236	FB_16BeatBasic1_N	4/4	1	90			:
Gtr	Pop Rock	1237	FC_16BeatBasic1_N	4/4	1	90			:
Gtr	Pop Rock	1238	BA_16BeatBasic1_N	4/4	1	90			:
Gtr	Pop Rock	1239	MA_Analog Pop	4/4	2	93			:
Gtr	Pop Rock	1240	MC_Analog Pop	4/4	1	93			:
Gtr	Pop Rock	1241	IA_Analog Pop	4/4	1	93			:
Gtr	Pop Rock	1242	MA_6/8 Pop_C	4/4	4	100			Od/Dist Guitar
Gtr	Pop Rock	1243	MB_6/8 Pop_C	4/4	4	100			:
Gtr	Pop Rock	1244	MC_6/8 Pop_C	4/4	4	100			:
Gtr	Pop Rock	1245	FA_6/8 Pop_C	4/4	1	100			:
Gtr	Pop Rock	1246	FB_6/8 Pop_C	4/4	1	100			:
Gtr	Pop Rock	1247	FC_6/8 Pop_C	4/4	1	100			:
Gtr	Pop Rock	1248	BA_6/8 Pop_C	4/4	1	100			:
Gtr	Pop Rock	1249	EA_6/8 Pop_C	4/4	3	123			:
Gtr	Pop Rock	1250	MA_6/8 Pop_N	4/4	4	100			:
Gtr	Pop Rock	1251	MB_6/8 Pop_N	4/4	4	100			:
Gtr	Pop Rock	1252	MC_6/8 Pop_N	4/4	4	100			:
Gtr	Pop Rock	1253	FA_6/8 Pop_N	4/4	1	100			:
Gtr	Pop Rock	1254	FB_6/8 Pop_N	4/4	1	100			:
Gtr	Pop Rock	1255	FC_6/8 Pop_N	4/4	1	100			:
Gtr	Pop Rock	1256	BA_6/8 Pop_N	4/4	1	100			:
Gtr	Ballad	1257	MA_Unplugged 3_C	4/4	4	113			Acoustic Guitar
Gtr	Ballad	1258	MB_Unplugged 3_C	4/4	4	113			:
Gtr	Ballad	1259	MC_Unplugged 3_C	4/4	4	113			:
Gtr	Ballad	1260	FA_Unplugged 3_C	4/4	1	113			:
Gtr	Ballad	1261	FB_Unplugged 3_C	4/4	1	113			:
Gtr	Ballad	1262	FC_Unplugged 3_C	4/4	1	113			:
Gtr	Ballad	1263	BA_Unplugged 3_C	4/4	1	113			:
Gtr	Ballad	1264	MA_Unplugged 3_N	4/4	4	113			:
Gtr	Ballad	1265	MB_Unplugged 3_N	4/4	4	113			:
Gtr	Ballad	1266	MC_Unplugged 3_N	4/4	4	113			:
Gtr	Ballad	1267	FA_Unplugged 3_N	4/4	1	113			:
Gtr	Ballad	1268	FB_Unplugged 3_N	4/4	1	113			:
Gtr	Ballad	1269	FC_Unplugged 3_N	4/4	1	113			:
Gtr	Ballad	1270	BA_Unplugged 3_N	4/4	1	113			:
Gtr	Ballad	1271	MA_Unplugged 4	4/4	4	120			:
Gtr	Ballad	1272	MB_Unplugged 4	4/4	2	120			:
Gtr	Ballad	1273	MC_Unplugged 4	4/4	2	120			:
Gtr	Ballad	1274	MD_Unplugged 4	4/4	2	120			:
Gtr	Ballad	1275	FA_Unplugged 4	4/4	1	120			:
Gtr	Ballad	1276	FB_Unplugged 4	4/4	1	120			:
Gtr	Ballad	1277	EA_Unplugged 4	4/4	4	120			:
Gtr	Ballad	1278	EB_Unplugged 4	4/4	3	120			:
Gtr	Ballad	1279	MA_8Beat Ballad2_C	4/4	4	101			:
Gtr	Ballad	1280	MB_8Beat Ballad2_C	4/4	4	101			:
Gtr	Ballad	1281	MC_8Beat Ballad2_C	4/4	4	101			:
Gtr	Ballad	1282	FA_8Beat Ballad2_C	4/4	1	101			:
Gtr	Ballad	1283	FB_8Beat Ballad2_C	4/4	1	101			:
Gtr	Ballad	1284	FC_8Beat Ballad2_C	4/4	1	101			:
Gtr	Ballad	1285	BA_8Beat Ballad2_C	4/4	1	101			:
Gtr	Ballad	1286	EA_8Beat Ballad2_C	4/4	5	101			:
Gtr	Ballad	1287	EB_8Beat Ballad2_C	4/4	5	101			:
Gtr	Ballad	1288	MA_8Beat Ballad2	4/4	4	101			:
Gtr	Ballad	1289	MB_8Beat Ballad2	4/4	4	101			:
Gtr	Ballad	1290	MC_8Beat Ballad2	4/4	4	101			:
Gtr	Ballad	1291	FA_8Beat Ballad2	4/4	1	101			:
Gtr	Ballad	1292	FB_8Beat Ballad2	4/4	1	101			:
Gtr	Ballad	1293	FC_8Beat Ballad2	4/4	1	101			:
Gtr	Ballad	1294	BA_8Beat Ballad2	4/4	1	101			:
Gtr	Ballad	1295	MA_Slowfeel	4/4	1	74			:
Gtr	Ballad	1296	MB_Slowfeel	4/4	1	74			:
Gtr	Ballad	1297	MC_Slowfeel	4/4	1	74			Clean Guitar
Gtr	Ballad	1298	MA_16Bt Ballad2_C	4/4	4	75			:
Gtr	Ballad	1299	MB_16Bt Ballad2_C	4/4	4	75			:
Gtr	Ballad	1300	MC_16Bt Ballad2_C	4/4	4	75			:
Gtr	Ballad	1301	FA_16Bt Ballad2_C	4/4	1	75			:
Gtr	Ballad	1302	FB_16Bt Ballad2_C	4/4	1	75			:
Gtr	Ballad	1303	FC_16Bt Ballad2_C	4/4	1	75			:
Gtr	Ballad	1304	BA_16Bt Ballad2_C	4/4	1	75			:
Gtr	Ballad	1305	MA_16Bt Ballad2_N	4/4	4	75			:

Main Category	Sub Category	ARP No.	ARP Name	Time Signature	Length	Original Tempo	Accent	Random SFX	Sound Type
Gtr	Ballad	1306	MB_16Bt Ballad2_N	4/4	4	75			:
Gtr	Ballad	1307	MC_16Bt Ballad2_N	4/4	4	75			:
Gtr	Ballad	1308	FA_16Bt Ballad2_N	4/4	1	75			:
Gtr	Ballad	1309	FB_16Bt Ballad2_N	4/4	1	75			:
Gtr	Ballad	1310	FC_16Bt Ballad2_N	4/4	1	75			:
Gtr	Ballad	1311	BA_16Bt Ballad2_N	4/4	1	75			:
Gtr	Ballad	1312	MA_6/8 Ballad_C	6/8	4	87			Od/Dist Guitar
Gtr	Ballad	1313	MB_6/8 Ballad_C	6/8	4	87			:
Gtr	Ballad	1314	MC_6/8 Ballad_C	6/8	4	87			:
Gtr	Ballad	1315	FA_6/8 Ballad_C	6/8	1	87			:
Gtr	Ballad	1316	FB_6/8 Ballad_C	6/8	1	87			:
Gtr	Ballad	1317	FC_6/8 Ballad_C	6/8	1	87			:
Gtr	Ballad	1318	BA_6/8 Ballad_C	6/8	1	87			:
Gtr	Ballad	1319	EA_6/8 Ballad_C	6/8	6	87			:
Gtr	Ballad	1320	EB_6/8 Ballad_C	6/8	6	87			:
Gtr	Ballad	1321	MA_6/8 Ballad_N	6/8	4	87			:
Gtr	Ballad	1322	MB_6/8 Ballad_N	6/8	4	87			:
Gtr	Ballad	1323	MC_6/8 Ballad_N	6/8	4	87			:
Gtr	Ballad	1324	FA_6/8 Ballad_N	6/8	1	87			:
Gtr	Ballad	1325	FB_6/8 Ballad_N	6/8	1	87			:
Gtr	Ballad	1326	FC_6/8 Ballad_N	6/8	1	87			:
Gtr	Ballad	1327	BA_6/8 Ballad_N	6/8	1	87			:
Gtr	Hip Hop	1328	MA_PepRally_N	4/4	1	75			Clean Guitar
Gtr	Hip Hop	1329	MB_PepRally_N	4/4	1	75			:
Gtr	Hip Hop	1330	MC_PepRally_N	4/4	1	75			:
Gtr	Hip Hop	1331	MD_PepRally_N	4/4	1	75			:
Gtr	Hip Hop	1332	MA_Hip Hop 2_N	4/4	2	94			Mute Guitar
Gtr	Hip Hop	1333	MC_Hip Hop 2_N	4/4	2	94			:
Gtr	Hip Hop	1334	MD_Hip Hop 2_N	4/4	2	94			:
Gtr	Hip Hop	1335	IA_Hip Hop 2_N	4/4	2	94			:
Gtr	Hip Hop	1336	MA1_Hip Hop 3	4/4	2	104			Acoustic Guitar
Gtr	Hip Hop	1337	MB1_Hip Hop 3	4/4	2	104			:
Gtr	Hip Hop	1338	MC1_Hip Hop 3	4/4	2	104			:
Gtr	Hip Hop	1339	MD1_Hip Hop 3	4/4	2	104			:
Gtr	Hip Hop	1340	FC1_Hip Hop 3	4/4	2	104			:
Gtr	Hip Hop	1341	MA2_Hip Hop 3_N	4/4	2	104			Mute Guitar
Gtr	Hip Hop	1342	MB2_Hip Hop 3_N	4/4	2	104			:
Gtr	Hip Hop	1343	MD2_Hip Hop 3_N	4/4	2	104			:
Gtr	Hip Hop	1344	FA2_Hip Hop 3_N	4/4	1	104			:
Gtr	Hip Hop	1345	FB2_Hip Hop 3_N	4/4	2	104			:
Gtr	Hip Hop	1346	MA1_Hip Hop 6_C	4/4	4	96			Acoustic Guitar
Gtr	Hip Hop	1347	MB1_Hip Hop 6_C	4/4	4	96			:
Gtr	Hip Hop	1348	MC1_Hip Hop 6_C	4/4	4	96			:
Gtr	Hip Hop	1349	FA1_Hip Hop 6_C	4/4	1	96			:
Gtr	Hip Hop	1350	FB1_Hip Hop 6_C	4/4	1	96			:
Gtr	Hip Hop	1351	FC1_Hip Hop 6_C	4/4	1	96			:
Gtr	Hip Hop	1352	BA1_Hip Hop 6_C	4/4	1	96			:
Gtr	Hip Hop	1353	MA2_Hip Hop 6_C	4/4	4	96			Od/Dist Guitar
Gtr	Hip Hop	1354	MB2_Hip Hop 6_C	4/4	4	96			:
Gtr	Hip Hop	1355	MC2_Hip Hop 6_C	4/4	4	96			:
Gtr	Hip Hop	1356	FA2_Hip Hop 6_C	4/4	1	96			:
Gtr	Hip Hop	1357	FB2_Hip Hop 6_C	4/4	1	96			:
Gtr	Hip Hop	1358	FC2_Hip Hop 6_C	4/4	1	96			:
Gtr	Hip Hop	1359	BA2_Hip Hop 6_C	4/4	1	96			:
Gtr	Hip Hop	1360	MA_Hip Rock 1_C	4/4	4	90			:
Gtr	Hip Hop	1361	MB_Hip Rock 1_C	4/4	4	90			:
Gtr	Hip Hop	1362	MC_Hip Rock 1_C	4/4	4	90			:
Gtr	Hip Hop	1363	FA_Hip Rock 1_C	4/4	1	90			:
Gtr	Hip Hop	1364	FB_Hip Rock 1_C	4/4	1	90			:
Gtr	Hip Hop	1365	FC_Hip Rock 1_C	4/4	1	90			:
Gtr	Hip Hop	1366	MA_Hip Rock 2_C	4/4	4	132			:
Gtr	Hip Hop	1367	MB_Hip Rock 2_C	4/4	4	132			:
Gtr	Hip Hop	1368	MC_Hip Rock 2_C	4/4	4	132			:
Gtr	Hip Hop	1369	FA_Hip Rock 2_C	4/4	1	132			:
Gtr	Hip Hop	1370	FB_Hip Rock 2_C	4/4	1	132			:
Gtr	Hip Hop	1371	FC_Hip Rock 2_C	4/4	1	132			:
Gtr	Hip Hop	1372	BA_Hip Rock 2_C	4/4	1	132			:
Gtr	Hip Hop	1373	MB1_ClassicHipHop_N	4/4	2	90			Clean Guitar
Gtr	Hip Hop	1374	MC1_ClassicHipHop_N	4/4	2	90			:
Gtr	Hip Hop	1375	MA2_ClassicHipHop	4/4	2	90			:
Gtr	Hip Hop	1376	MB2_ClassicHipHop	4/4	2	90			:
Gtr	Hip Hop	1377	MC2_ClassicHipHop	4/4	2	90			:
Gtr	Hip Hop	1378	IA2_ClassicHipHop	4/4	4	90			:
Gtr	Hip Hop	1379	MD3_ClassicHipHop	4/4	2	90			:
Gtr	Hip Hop	1380	FC3_ClassicHipHop	4/4	2	90			:
Gtr	Modern R&B	1381	MA_Pop Shuffle2_C	4/4	4	94			:
Gtr	Modern R&B	1382	MB_Pop Shuffle2_C	4/4	4	94			:
Gtr	Modern R&B	1383	MC_Pop Shuffle2_C	4/4	4	94			:
Gtr</									

Arpeggio Type List

Main Category	Sub Category	ARP No.	ARP Name	Time Signature	Length	Original Tempo	Accent	Random SFX	Sound Type
Gtr	Modern R&B	1393	FC_Pop Shuffle2_N	4/4	1	94			:
Gtr	Modern R&B	1394	BA_Pop Shuffle2_N	4/4	1	94			:
Gtr	Modern R&B	1395	MB_R&B Disco_N	4/4	2	110			Mute Guitar
Gtr	Modern R&B	1396	MC_R&B Disco_N	4/4	2	110			:
Gtr	Modern R&B	1397	MD_R&B Disco_N	4/4	2	110			:
Gtr	Modern R&B	1398	FB_R&B Disco_N	4/4	1	110			:
Gtr	Modern R&B	1399	FC_R&B Disco_N	4/4	2	110			:
Gtr	Modern R&B	1400	MA_New R&B 2	4/4	1	97			Acoustic Guitar
Gtr	Modern R&B	1401	MB_New R&B 2	4/4	1	123			:
Gtr	Modern R&B	1402	MC_New R&B 2	4/4	1	97			:
Gtr	Modern R&B	1403	IA_New R&B 2_N	4/4	2	97			:
Gtr	Modern R&B	1404	FA_New R&B 2	4/4	1	97			:
Gtr	Modern R&B	1405	FB_New R&B 2	4/4	1	97			:
Gtr	Modern R&B	1406	MA_New R&B 3	4/4	2	90			:
Gtr	Modern R&B	1407	MB_New R&B 3	4/4	2	90			:
Gtr	Modern R&B	1408	MC_New R&B 3_N	4/4	2	90			:
Gtr	Modern R&B	1409	MD_New R&B 3	4/4	2	90			:
Gtr	Modern R&B	1410	MA_Pop R&B_C	4/4	4	67			Hip-Hop Nylon Guitar
Gtr	Modern R&B	1411	MB_Pop R&B_C	4/4	4	67			:
Gtr	Modern R&B	1412	MC_Pop R&B_C	4/4	4	67			:
Gtr	Modern R&B	1413	FA_Pop R&B_C	4/4	1	67			:
Gtr	Modern R&B	1414	FB_Pop R&B_C	4/4	1	67			:
Gtr	Modern R&B	1415	FC_Pop R&B_C	4/4	1	67			:
Gtr	Modern R&B	1416	MA_H-R&B Pop_C	4/4	4	140			Acoustic Guitar
Gtr	Modern R&B	1417	MB_H-R&B Pop_C	4/4	4	140			:
Gtr	Modern R&B	1418	MC_H-R&B Pop_C	4/4	4	140			:
Gtr	Modern R&B	1419	FA_H-R&B Pop_C	4/4	1	140			:
Gtr	Modern R&B	1420	MD_6/8 R&B	4/4	2	61			Clean Guitar
Gtr	Modern R&B	1421	FA_6/8 R&B	4/4	1	61			:
Gtr	Modern R&B	1422	FB_6/8 R&B	4/4	1	61			:
Gtr	Modern R&B	1423	FC_6/8 R&B	4/4	2	61			:
Gtr	Modern R&B	1424	MA_Smooth 1	4/4	2	115			Acoustic Guitar
Gtr	Modern R&B	1425	MB_Smooth 1	4/4	2	115			:
Gtr	Modern R&B	1426	MC_Smooth 1	4/4	2	115			:
Gtr	Modern R&B	1427	MD_Smooth 1	4/4	2	115			:
Gtr	Modern R&B	1428	IA_Smooth 1	4/4	1	115			:
Gtr	Modern R&B	1429	FA_Smooth 1	4/4	1	115			:
Gtr	Modern R&B	1430	FB_Smooth 1	4/4	1	115			:
Gtr	Modern R&B	1431	FC_Smooth 1	4/4	2	115			:
Gtr	Modern R&B	1432	MA1_Flip Hop 1	4/4	1	132			Clean Guitar
Gtr	Modern R&B	1433	MB1_Flip Hop 1	4/4	2	132			:
Gtr	Modern R&B	1434	MC1_Flip Hop 1	4/4	2	132			Mute Guitar
Gtr	Modern R&B	1435	MD1_Flip Hop 1	4/4	2	132			:
Gtr	Modern R&B	1436	FA1_Flip Hop 1	4/4	1	132			:
Gtr	Modern R&B	1437	FC1_Flip Hop 1	4/4	1	132			:
Gtr	Modern R&B	1438	FA2_Flip Hop 1	4/4	1	132			Acoustic Guitar
Gtr	Modern R&B	1439	FB2_Flip Hop 1_N	4/4	1	132			:
Gtr	Modern R&B	1440	FC2_Flip Hop 1	4/4	2	132			:
Gtr	Modern R&B	1441	MA_New Gospel_N	4/4	2	90			Mute Guitar
Gtr	Modern R&B	1442	MB_New Gospel_N	4/4	2	90			:
Gtr	Modern R&B	1443	MC_New Gospel_N	4/4	2	90			:
Gtr	Modern R&B	1444	MD_New Gospel_N	4/4	2	90			:
Gtr	Modern R&B	1445	IA_New Gospel_N	4/4	1	90			:
Gtr	Modern R&B	1446	FA_New Gospel_N	4/4	1	90			:
Gtr	Modern R&B	1447	FB_New Gospel	4/4	1	90			:
Gtr	Modern R&B	1448	FC_New Gospel_N	4/4	2	90			:
Gtr	Classic R&B	1449	MA_Soul 2	4/4	1	120			Clean Guitar
Gtr	Classic R&B	1450	MB_Soul 2	4/4	1	120			:
Gtr	Classic R&B	1451	MC_Soul 2	4/4	1	120			:
Gtr	Classic R&B	1452	MD_Soul 2	4/4	4	120			:
Gtr	Classic R&B	1453	FC_Soul 2	4/4	4	120			:
Gtr	Funk	1454	MA_Funk 3	4/4	2	132			:
Gtr	Funk	1455	MB_Funk 3	4/4	1	132			:
Gtr	Funk	1456	MC_Funk 3	4/4	1	132			:
Gtr	Funk	1457	MD_Funk 3	4/4	4	132			:
Gtr	Funk	1458	IA_Funk 3	4/4	1	132			:
Gtr	Funk	1459	FB_Funk 3	4/4	1	132			:
Gtr	Funk	1460	FC_Funk 3	4/4	2	132			:
Gtr	Funk	1461	MA_Cool Funk_N	4/4	2	96			:
Gtr	Funk	1462	MB_Cool Funk	4/4	1	96			:
Gtr	Funk	1463	MD_Cool Funk	4/4	2	96			:
Gtr	Funk	1464	IA_Cool Funk	4/4	2	96			:
Gtr	Funk	1465	FC_Cool Funk	4/4	1	96			:
Gtr	Funk	1466	MA_Jazz Funk 2	4/4	2	120			:
Gtr	Funk	1467	MB_Jazz Funk 2	4/4	2	120			:
Gtr	Funk	1468	MC_Jazz Funk 2	4/4	1	120			:
Gtr	Funk	1469	MD_Jazz Funk 2	4/4	2	120			:
Gtr	Funk	1470	IA_Jazz Funk 2	4/4	2	120			:
Gtr	Funk	1471	FB_Jazz Funk 2	4/4	1	120			:
Gtr	Funk	1472	FC_Jazz Funk 2	4/4	1	120			:
Gtr	Funk	1473	MA_Funky1	4/4	2	120			:
Gtr	Funk	1474	MA_Funky2	4/4	2	120			:
Gtr	Funk	1475	MA_Funky3	4/4	2	120			:
Gtr	Funk	1476	MA_Funky4	4/4	1	120			:
Gtr	Funk	1477	MA_Funk Guitar	4/4	2	116			Mute Guitar
Gtr	Funk	1478	MA_CleanGuitarA1	4/4	2	120			Clean Guitar
Gtr	Funk	1479	MA_CleanGuitarA2	4/4	2	120			:

Main Category	Sub Category	ARP No.	ARP Name	Time Signature	Length	Original Tempo	Accent	Random SFX	Sound Type
Gtr	Funk	1480	MA_CleanGuitarA3	4/4	2	120			:
Gtr	Funk	1481	MA_CleanGuitarA4	4/4	2	120			:
Gtr	Funk	1482	MA_CleanGuitarB1_N	4/4	4	127			:
Gtr	Funk	1483	MA_CleanGuitarB2_N	4/4	4	107			:
Gtr	Funk	1484	MA_CleanGuitarB3_N	4/4	4	107			:
Gtr	Funk	1485	MA_CleanGuitarB4_N	4/4	4	107			:
Gtr	Funk	1486	MA_CleanGuitarB5	4/4	4	107			:
Gtr	Funk	1487	MA_News1	4/4	2	120			:
Gtr	Funk	1488	MA_News2	4/4	2	120			Mute Guitar
Gtr	Funk	1489	MA_Spanky	4/4	2	105			Clean Guitar
Gtr	House	1490	MA1_Retro Pop_N	4/4	2	126			Acoustic Guitar
Gtr	House	1491	MA2_Retro Pop	4/4	2	126			Clean Guitar
Gtr	House	1492	MA_Disco House	4/4	2	128			:
Gtr	House	1493	MB_Disco House	4/4	2	128			:
Gtr	House	1494	MC_Disco House	4/4	2	128			:
Gtr	House	1495	MD_Disco House	4/4	2	128			:
Gtr	House	1496	IA_Disco House	4/4	4	128			:
Gtr	House	1497	FA_Disco House	4/4	1	128			:
Gtr	House	1498	FB_Disco House	4/4	1	128			:
Gtr	House	1499	FC_Disco House	4/4	4	128			:
Gtr	D&B	1500	MA_Big Beat 1_N	4/4	4	115			Od/Dist Guitar
Gtr	D&B	1501	MA_Big Beat 1_N	4/4	4	115			:
Gtr	D&B	1502	MC_Big Beat 1_N	4/4	4	115			:
Gtr	D&B	1503	FA_Big Beat 1	4/4	1	115			:
Gtr	D&B	1504	FB_Big Beat 1	4/4	1	115			:
Gtr	D&B	1505	FC_Big Beat 1_N	4/4	1	115			:
Gtr	D&B	1506	BA_Big Beat 1_N	4/4	1	115			:
Gtr	D&B	1507	MA_Big Beat 2_N	4/4	4	145			:
Gtr	D&B	1508	MB_Big Beat 2_N	4/4	8	145			:
Gtr	D&B	1509	MC_Big Beat 2_N	4/4	4	145			:
Gtr	D&B	1510	FA_Big Beat 2	4/4	1	145			:
Gtr	D&B	1511	FB_Big Beat 2_N	4/4	1	145			:
Gtr	D&B	1512	FC_Big Beat 2_N	4/4	1	145			:
Gtr	D&B	1513	BA_Big Beat 2_N	4/4	2	145			:
Gtr	Chill	1514	MA1_Chill Out	4/4	2	79			Clean Guitar
Gtr	Chill	1515	MA2_Chill Out	4/4	1	79			Acoustic Guitar
Gtr	Chill	1516	MB2_Chill Out	4/4	2	79			:
Gtr	Chill	1517	MC2_Chill Out	4/4	2	79			:
Gtr	Chill	1518	MD2_Chill Out	4/4	2	79			:
Gtr	Jazz	1519	MA_AcousticJazz_N	4/4	4	204			Clean Guitar
Gtr	Jazz	1520	MB_AcousticJazz_N	4/4	4	204			:
Gtr	Jazz	1521	MC_AcousticJazz_N	4/4	4	204			:
Gtr	Jazz	1522	MD_AcousticJazz_N	4/4	4	204			:
Gtr	Jazz	1523	IA_AcousticJazz_N	4/4	4	204			:
Gtr	Jazz	1524	FA_AcousticJazz_N	4/4	1	204			:
Gtr	Jazz	1525	FB_AcousticJazz_N	4/4	1	204			:
Gtr	Jazz	1526	FC_AcousticJazz_N	4/4	4	204			:
Gtr	Jazz	1527	MA_Modern Jazz_C	4/4	16	218			:
Gtr	Jazz	1528	MB_Modern Jazz_C	4/4	16	218			:
Gtr	Jazz	1529	MC_Modern Jazz_C	4/4	16	218			:
Gtr	Jazz	1530	FA_Modern Jazz_C	4/4	1	218			:
Gtr	Jazz	1531	FB_Modern Jazz_C	4/4	1	218			:
Gtr	Jazz	1532	FC_Modern Jazz_C	4/4	1	218			:
Gtr	Jazz	1533	BA_Modern Jazz_C	4/4	1	218			:
Gtr	Jazz	1534	EA_Modern Jazz_C	4/4	6	218			:
Gtr	Jazz	1535	EB_Modern Jazz_C	4/4	7	218			:
Gtr	Jazz	1536	MA_R&R Shuffle_C	4/4	4	192			:
Gtr	Jazz	1537	MB_R&R Shuffle_C	4/4	4	192			:
Gtr	Jazz	1538	MC_R&R Shuffle_C	4/4	4	192			:
Gtr	Jazz	1539	FA_R&R Shuffle_C	4/4	1	192			:
Gtr	Jazz	1540	FB_R&R Shuffle_C	4/4	1	192			:
Gtr	Jazz	1541	FC_R&R Shuffle_C	4/4	1	192			:
Gtr	Jazz	1542	BA_R&R Shuffle_C	4/4	1	192			:
Gtr	Jazz	1543	EA_R&R Shuffle_C	4/4	5	192			:
Gtr	Jazz	1544	EB_R&R Shuffle_C	4/4	5	192			:
Gtr	Jazz	1545	MA_Slow Blues 2_C	4/4	4	72			Mid Drive (2handGtr)
Gtr	Jazz	1546	MB_Slow Blues 2_C	4/4	4	72			:
Gtr	Jazz	1547	MC_Slow Blues 2_C	4/4	4	72			:
Gtr	Jazz	1548	FA_Slow Blues 2_C	4/4	1	72			:
Gtr	Jazz	1549	FB_Slow Blues 2_C	4/4	1	72			:
Gtr	Jazz	1550	FC_Slow Blues 2_C	4/4	1	72			:
Gtr	Jazz	1551	BA_Slow Blues 2_C	4/4	1	72			:
Gtr	Jazz	1552	MA_Slow Blues 2_N	4/4	4	72			:
Gtr	Jazz	1553	MB_Slow Blues 2_N	4/4	4	72			:
Gtr	Jazz	1554	MC_Slow Blues 2	4/4	4	72			:
Gtr	Jazz	1555	FA_Slow Blues 2_N	4/4	1	72			:
Gtr	Jazz	1556	FB_Slow Blues 2	4/4	1	72			:
Gtr	Jazz	1557	FC_Slow Blues 2	4/4	1	72			:
Gtr	Jazz								

Main Category	Sub Category	ARP No.	ARP Name	Time Signature	Length	Original Tempo	Accent	Random SFX	Sound Type
Gtr	Latin	1567	FC_Montuno_N	4/4	1	100			:
Gtr	Latin	1568	MA_Samba	4/4	4	120			:
Gtr	Latin	1569	MB_Samba	4/4	4	120			:
Gtr	Latin	1570	MD_Samba	4/4	4	120			:
Gtr	Latin	1571	IA_Samba	4/4	2	120			:
Gtr	Latin	1572	MA_Bomba_C	4/4	4	99			:
Gtr	Latin	1573	MB_Bomba_C	4/4	4	99			:
Gtr	Latin	1574	MC_Bomba_C	4/4	4	99			:
Gtr	Latin	1575	FA_Bomba_C	4/4	1	99			:
Gtr	Latin	1576	FB_Bomba_C	4/4	1	99			:
Gtr	Latin	1577	FC_Bomba_C	4/4	1	99			:
Gtr	Latin	1578	BA_Bomba_C	4/4	1	99			:
Gtr	Latin	1579	EA_Bomba_C	4/4	3	99			:
Gtr	Latin	1580	EB_Bomba_C	4/4	3	99			:
Gtr	Latin	1581	MA_Bomba_N	4/4	4	99			:
Gtr	Latin	1582	MB_Bomba	4/4	4	99			:
Gtr	Latin	1583	MC_Bomba_N	4/4	4	99			:
Gtr	Latin	1584	FA_Bomba	4/4	1	99			:
Gtr	Latin	1585	FB_Bomba	4/4	1	99			:
Gtr	Latin	1586	FC_Bomba_N	4/4	1	99			:
Gtr	Latin	1587	BA_Bomba	4/4	1	99			:
Gtr	Latin	1588	MA_Guaguanco_C	4/4	4	120			:
Gtr	Latin	1589	MB_Guaguanco_C	4/4	4	120			:
Gtr	Latin	1590	MC_Guaguanco_C	4/4	4	120			:
Gtr	Latin	1591	FA_Guaguanco_C	4/4	1	120			:
Gtr	Latin	1592	FB_Guaguanco_C	4/4	1	120			:
Gtr	Latin	1593	FC_Guaguanco_C	4/4	1	120			:
Gtr	Latin	1594	BA_Guaguanco_C	4/4	1	120			:
Gtr	Latin	1595	EA_Guaguanco_C	4/4	3	120			:
Gtr	Latin	1596	EB_Guaguanco_C	4/4	3	120			:
Gtr	Latin	1597	MC1_Latin Rock	4/4	2	120			Clean Guitar
Gtr	Latin	1598	FB1_Latin Rock	4/4	1	120			:
Gtr	Latin	1599	MB2_Latin Rock	4/4	1	120			Acoustic Guitar
Gtr	Latin	1600	MC2_Latin Rock	4/4	2	120			:
Gtr	Latin	1601	MA_LatinPhrase1	4/4	2	120			:
Gtr	Latin	1602	MA_LatinPhrase2	4/4	2	120			:
Gtr	Latin	1603	MA_LatinPhrase3	4/4	1	120			:
Gtr	Latin	1604	MA_SteelGuitar1_N	4/4	4	120			:
Gtr	Latin	1605	MA_SteelGuitar2_N	4/4	4	120			:
Gtr	Latin	1606	MA_SteelGuitar3_N	4/4	4	120			:
Gtr	Latin	1607	MA_SteelGuitar4_N	4/4	4	120			:
Gtr	World	1608	MA1_Reggae 1	4/4	1	102			Clean Guitar
Gtr	World	1609	MB1_Reggae 1	4/4	2	102			:
Gtr	World	1610	MD1_Reggae 1	4/4	2	90			:
Gtr	World	1611	IA1_Reggae 1	4/4	1	102			:
Gtr	World	1612	FC1_Reggae 1	4/4	2	96			:
Gtr	World	1613	MA2_Reggae 1	4/4	4	102			Mute Guitar
Gtr	World	1614	MB2_Reggae 1	4/4	4	102			:
Gtr	World	1615	MA_Reggae 2	4/4	2	92			Clean Guitar
Gtr	World	1616	MB_Reggae 2	4/4	1	92			:
Gtr	World	1617	IA_Reggae 2	4/4	2	92			:
Gtr	World	1618	MA1_Spanish Pop	4/4	2	120			Acoustic Guitar
Gtr	World	1619	MB1_Spanish Pop	4/4	2	120			:
Gtr	World	1620	MD1_Spanish Pop	4/4	2	120			:
Gtr	World	1621	FA1_Spanish Pop	4/4	1	120			:
Gtr	World	1622	FB1_Spanish Pop	4/4	1	120			:
Gtr	World	1623	IA2_Spanish Pop	4/4	4	120			:
Gtr	World	1624	FC2_Spanish Pop	4/4	3	120			:
Gtr	World	1625	MA3_Spanish Pop	4/4	2	120			:
Gtr	World	1626	MB3_Spanish Pop	4/4	2	120			:
Gtr	World	1627	MC3_Spanish Pop	4/4	2	120			:
Gtr	World	1628	MD3_Spanish Pop	4/4	2	120			:
Gtr	World	1629	IA3_Spanish Pop	4/4	4	120			:
Gtr	World	1630	FA3_Spanish Pop	4/4	1	120			:
Gtr	World	1631	FB3_Spanish Pop	4/4	1	120			:
Gtr	General	1632	MA_Strum1	4/4	1	120			:
Gtr	General	1633	MA_Strum2	4/4	2	120			:
Gtr	General	1634	MA_Strum3	4/4	4	120			:
Gtr	General	1635	MA_Strum4	4/4	2	120			:
Gtr	General	1636	MA_Strum5	4/4	2	120			:
Gtr	General	1637	MA_Strum6	4/4	2	120			:
Gtr	General	1638	MA_Strum7	4/4	2	120			:
Gtr	General	1639	MA_Strum8	4/4	2	120			:
Gtr	General	1640	MA_Strum9	4/4	2	120			:
Gtr	General	1641	MA_Strum10	4/4	2	120			:
Gtr	General	1642	MA_Guitar Arp1	4/4	1	120			:
Gtr	General	1643	MA_Guitar Arp2	4/4	1	120			:
Gtr	General	1644	MA_Guitar Arp3	4/4	1	120			:
Gtr	General	1645	MA_Guitar Arp4	4/4	1	120			:
Gtr	General	1646	MA_RollArp	4/4	4	60			:
Gtr	General	1647	Tremolo	4/4	1	100			:
Gtr	General	1648	Lick1	4/4	4	120			Od/Dist Guitar
Gtr	General	1649	Lick2	4/4	4	120			:
Gtr	General	1650	Lick3	4/4	4	120			:
Gtr	General	1651	Lick4	4/4	2	120			:
Gtr	General	1652	Lick5	4/4	4	120			:
Gtr	General	1653	Lick6	4/4	1	120			:

Main Category	Sub Category	ARP No.	ARP Name	Time Signature	Length	Original Tempo	Accent	Random SFX	Sound Type
Gtr	Rock	1654	[Mg]MA1_StdrrRk_C	4/4	4	131		●	Mega 60s Tube Tone
Gtr	Rock	1655	[Mg]MB1_StdrrRk_C	4/4	4	131		●	:
Gtr	Rock	1656	[Mg]MC1_StdrrRk_C	4/4	4	131		●	:
Gtr	Rock	1657	[Mg]FA1_StdrrRk_C	4/4	1	131		●	:
Gtr	Rock	1658	[Mg]FB1_StdrrRk_C	4/4	1	131		●	:
Gtr	Rock	1659	[Mg]FC1_StdrrRk_C	4/4	1	131		●	:
Gtr	Rock	1660	[Mg]BA1_StdrrRk_C	4/4	1	131		●	:
Gtr	Rock	1661	[Mg]EA1_StdrrRk_C	4/4	4	131		●	:
Gtr	Rock	1662	[Mg]EB1_StdrrRk_C	4/4	6	131		●	:
Gtr	Rock	1663	[Mg]MA2_StdrrRk_C	4/4	4	131		●	Mega 1coil Slap Dist
Gtr	Rock	1664	[Mg]MB2_StdrrRk_C	4/4	4	131		●	:
Gtr	Rock	1665	[Mg]MC2_StdrrRk_C	4/4	4	131		●	:
Gtr	Rock	1666	[Mg]FA2_StdrrRk_C	4/4	1	131		●	:
Gtr	Rock	1667	[Mg]FB2_StdrrRk_C	4/4	1	131		●	:
Gtr	Rock	1668	[Mg]FC2_StdrrRk_C	4/4	1	131		●	:
Gtr	Rock	1669	[Mg]BA2_StdrrRk_C	4/4	1	131		●	:
Gtr	Rock	1670	[Mg]EA2_StdrrRk_C	4/4	4	131		●	:
Gtr	Rock	1671	[Mg]EB2_StdrrRk_C	4/4	6	131		●	:
Gtr	Rock	1672	[Mg]MA1_OvdrPwrk_C	4/4	4	120		●	Mega Ovdr Distortion
Gtr	Rock	1673	[Mg]MB1_OvdrPwrk_C	4/4	4	120		●	:
Gtr	Rock	1674	[Mg]MC1_OvdrPwrk_C	4/4	4	120		●	:
Gtr	Rock	1675	[Mg]FA1_OvdrPwrk_C	4/4	1	120		●	:
Gtr	Rock	1676	[Mg]FB1_OvdrPwrk_C	4/4	1	120		●	:
Gtr	Rock	1677	[Mg]FC1_OvdrPwrk_C	4/4	1	120		●	:
Gtr	Rock	1678	[Mg]BA1_OvdrPwrk_C	4/4	1	120		●	:
Gtr	Rock	1679	[Mg]EA1_OvdrPwrk_C	4/4	4	120		●	:
Gtr	Rock	1680	[Mg]EB1_OvdrPwrk_C	4/4	7	120		●	:
Gtr	Rock	1681	[Mg]MA1_OvdrPwrk	4/4	4	120		●	:
Gtr	Rock	1682	[Mg]MB1_OvdrPwrk	4/4	4	120		●	:
Gtr	Rock	1683	[Mg]MC1_OvdrPwrk	4/4	4	120		●	:
Gtr	Rock	1684	[Mg]FA1_OvdrPwrk	4/4	1	120		●	:
Gtr	Rock	1685	[Mg]FB1_OvdrPwrk	4/4	1	120		●	:
Gtr	Rock	1686	[Mg]FC1_OvdrPwrk	4/4	1	120		●	:
Gtr	Rock	1687	[Mg]BA1_OvdrPwrk	4/4	1	120		●	:
Gtr	Rock	1688	[Mg]MA2_OvdrPwrk_C	4/4	4	120		●	Mega Ovdr Fuzz
Gtr	Rock	1689	[Mg]MB2_OvdrPwrk_C	4/4	4	120		●	:
Gtr	Rock	1690	[Mg]MC2_OvdrPwrk_C	4/4	4	120		●	:
Gtr	Rock	1691	[Mg]FA2_OvdrPwrk_C	4/4	1	120		●	:
Gtr	Rock	1692	[Mg]FB2_OvdrPwrk_C	4/4	1	120		●	:
Gtr	Rock	1693	[Mg]FC2_OvdrPwrk_C	4/4	1	120		●	:
Gtr	Rock	1694	[Mg]BA2_OvdrPwrk_C	4/4	1	120		●	:
Gtr	Rock	1695	[Mg]EA2_OvdrPwrk_C	4/4	4	120		●	:
Gtr	Rock	1696	[Mg]EB2_OvdrPwrk_C	4/4	7	120		●	:
Gtr	Rock	1697	[Mg]MA2_OvdrPwrk	4/4	4	120		●	:
Gtr	Rock	1698	[Mg]MB2_OvdrPwrk	4/4	4	120		●	:
Gtr	Rock	1699	[Mg]MC2_OvdrPwrk	4/4	4	120		●	:
Gtr	Rock	1700	[Mg]FA2_OvdrPwrk	4/4	1	120		●	:
Gtr	Rock	1701	[Mg]FB2_OvdrPwrk	4/4	1	120		●	:
Gtr	Rock	1702	[Mg]FC2_OvdrPwrk	4/4	1	120		●	:
Gtr	Rock	1703	[Mg]BA2_OvdrPwrk	4/4	1	120		●	:
Gtr	Rock	1704	[Mg]MA_CntmpRock_C	4/4	4	126		●	Mega 1coil Slap Dist
Gtr	Rock	1705	[Mg]MB_CntmpRock_C	4/4	4	126		●	:
Gtr	Rock	1706	[Mg]MC_CntmpRock_C	4/4	4	126		●	:
Gtr	Rock	1707	[Mg]FA_CntmpRock_C	4/4	1	126		●	:
Gtr	Rock	1708	[Mg]FB_CntmpRock_C	4/4	1	126		●	:
Gtr	Rock	1709	[Mg]FC_CntmpRock_C	4/4	1	126		●	:
Gtr	Rock	1710	[Mg]BA_CntmpRock_C	4/4	1	126		●	:
Gtr	Rock	1711	[Mg]EA_CntmpRock_C	4/4	4	126		●	:
Gtr	Rock	1712	[Mg]EB_CntmpRock_C	4/4	4	126		●	:
Gtr	Rock	1713	[Mg]MA1_HardRock_C	4/4	4	120		●	Mega 60s Tube Tone
Gtr	Rock	1714	[Mg]MB1_HardRock_C	4/4	4	120		●	:
Gtr	Rock	1715	[Mg]MC1_HardRock_C	4/4	4	120		●	:
Gtr	Rock	1716	[Mg]FA1_HardRock_C	4/4	1	120		●	:
Gtr	Rock	1717	[Mg]FB1_HardRock_C	4/4	1	120		●	:
Gtr	Rock	1718	[Mg]FC1_HardRock_C	4/4	1	120		●	:
Gtr	Rock	1719	[Mg]BA1_HardRock_C	4/4	1	120		●	:
Gtr	Rock	1720	[Mg]EA1_HardRock_C	4/4	3	120		●	:
Gtr	Rock	1721	[Mg]EB1_HardRock_C	4/4	6	120		●	:
Gtr	Rock	1722	[Mg]MA2_HardRock_C	4/4	4	120		●	:
Gtr	Rock	1723	[Mg]MB2_HardRock_C	4/4	4	120		●	:
Gtr	Rock	1724	[Mg]MC2_HardRock_C	4/4	4	120		●	:
Gtr	Rock	1725	[Mg]FA2_HardRock_C	4/4	1	120		●	:
Gtr	Rock	1726	[Mg]FB2_HardRock_C	4/4	1	120		●	:
Gtr	Rock	1727	[Mg]FC2_HardRock_C	4/4	1	120		●	:
Gtr	Rock	1728	[Mg]BA2_HardRock_C	4/4	1	120		●	:
Gtr	Rock	1729	[Mg]EA2_HardRock_C	4/4	3	120		●	:
Gtr	Rock	1730	[Mg]EB2_HardRock_C	4/4	6</				

Main Category	Sub Category	ARP No.	ARP Name	Time Signature	Length	Original Tempo	Accent	Random SFX	Sound Type
Gtr	Rock	1741	[Mg]MB2_BluesRck_C	4/4	4	120		●	:
Gtr	Rock	1742	[Mg]MC2_BluesRck_C	4/4	4	120		●	:
Gtr	Rock	1743	[Mg]FA2_BluesRck_C	4/4	1	120		●	:
Gtr	Rock	1744	[Mg]FB2_BluesRck_C	4/4	1	120		●	:
Gtr	Rock	1745	[Mg]FC2_BluesRck_C	4/4	1	120		●	:
Gtr	Rock	1746	[Mg]BA2_BluesRck_C	4/4	1	120		●	:
Gtr	Rock	1747	[Mg]EA2_BluesRck_C	4/4	3	120		●	:
Gtr	Rock	1748	[Mg]EB2_BluesRck_C	4/4	5	120		●	:
Gtr	Rock	1749	[Mg]MA1_RkShflle_C	4/4	4	121		●	Mega 1coil Old R&R
Gtr	Rock	1750	[Mg]MB1_RkShflle_C	4/4	4	121		●	:
Gtr	Rock	1751	[Mg]MC1_RkShflle_C	4/4	4	121		●	:
Gtr	Rock	1752	[Mg]FA1_RkShflle_C	4/4	1	121		●	:
Gtr	Rock	1753	[Mg]FB1_RkShflle_C	4/4	1	121		●	:
Gtr	Rock	1754	[Mg]FC1_RkShflle_C	4/4	1	121		●	:
Gtr	Rock	1755	[Mg]BA1_RkShflle_C	4/4	1	121		●	:
Gtr	Rock	1756	[Mg]EA1_RkShflle_C	4/4	6	121		●	:
Gtr	Rock	1757	[Mg]MA2_RkShflle_C	4/4	4	121		●	Mega 60s Blues Tone
Gtr	Rock	1758	[Mg]MB2_RkShflle_C	4/4	4	121		●	:
Gtr	Rock	1759	[Mg]MC2_RkShflle_C	4/4	4	121		●	:
Gtr	Rock	1760	[Mg]FA2_RkShflle_C	4/4	1	121		●	:
Gtr	Rock	1761	[Mg]FB2_RkShflle_C	4/4	1	121		●	:
Gtr	Rock	1762	[Mg]FC2_RkShflle_C	4/4	1	121		●	:
Gtr	Rock	1763	[Mg]BA2_RkShflle_C	4/4	1	121		●	:
Gtr	Rock	1764	[Mg]EA2_RkShflle_C	4/4	6	121		●	:
Gtr	Rock	1765	[Mg]MA_Rock&Roll_C	4/4	4	172		●	Mega 60s Clean
Gtr	Rock	1766	[Mg]MB_Rock&Roll_C	4/4	4	172		●	:
Gtr	Rock	1767	[Mg]MC_Rock&Roll_C	4/4	4	172		●	:
Gtr	Rock	1768	[Mg]FA_Rock&Roll_C	4/4	1	172		●	:
Gtr	Rock	1769	[Mg]FB_Rock&Roll_C	4/4	1	172		●	:
Gtr	Rock	1770	[Mg]FC_Rock&Roll_C	4/4	1	172		●	:
Gtr	Rock	1771	[Mg]BA_Rock&Roll_C	4/4	1	172		●	:
Gtr	Rock	1772	[Mg]EA_Rock&Roll_C	4/4	5	172		●	:
Gtr	Rock	1773	[Mg]EB_Rock&Roll_C	4/4	6	172		●	:
Gtr	Pop Rock	1774	[Mg]MA_8Beat Med_C	4/4	4	105		●	Mega 60s Tremolo
Gtr	Pop Rock	1775	[Mg]MB_8Beat Med_C	4/4	4	105		●	:
Gtr	Pop Rock	1776	[Mg]MC_8Beat Med_C	4/4	4	105		●	:
Gtr	Pop Rock	1777	[Mg]MD_8Beat Med_C	4/4	4	105		●	:
Gtr	Pop Rock	1778	[Mg]FA_8Beat Med_C	4/4	1	105		●	:
Gtr	Pop Rock	1779	[Mg]FB_8Beat Med_C	4/4	1	105		●	:
Gtr	Pop Rock	1780	[Mg]FC_8Beat Med_C	4/4	1	105		●	:
Gtr	Pop Rock	1781	[Mg]FD_8Beat Med_C	4/4	1	105		●	:
Gtr	Pop Rock	1782	[Mg]EA_8Beat Med_C	4/4	4	105		●	:
Gtr	Pop Rock	1783	[Mg]MA1_8Bl Fast_C	4/4	4	140		●	Mega Steel
Gtr	Pop Rock	1784	[Mg]MB1_8Bl Fast_C	4/4	4	140		●	:
Gtr	Pop Rock	1785	[Mg]MC1_8Bl Fast_C	4/4	4	140		●	:
Gtr	Pop Rock	1786	[Mg]MD1_8Bl Fast_C	4/4	4	140		●	:
Gtr	Pop Rock	1787	[Mg]FA1_8Bl Fast_C	4/4	1	140		●	:
Gtr	Pop Rock	1788	[Mg]FB1_8Bl Fast_C	4/4	1	140		●	:
Gtr	Pop Rock	1789	[Mg]FC1_8Bl Fast_C	4/4	1	140		●	:
Gtr	Pop Rock	1790	[Mg]FD1_8Bl Fast_C	4/4	1	140		●	:
Gtr	Pop Rock	1791	[Mg]EA1_8Bl Fast_C	4/4	5	140		●	:
Gtr	Pop Rock	1792	[Mg]MA2_8Bl Fast_C	4/4	4	140		●	Mega 60s Clean
Gtr	Pop Rock	1793	[Mg]MB2_8Bl Fast_C	4/4	4	140		●	:
Gtr	Pop Rock	1794	[Mg]MC2_8Bl Fast_C	4/4	4	140		●	:
Gtr	Pop Rock	1795	[Mg]MD2_8Bl Fast_C	4/4	4	140		●	:
Gtr	Pop Rock	1796	[Mg]FA2_8Bl Fast_C	4/4	1	140		●	:
Gtr	Pop Rock	1797	[Mg]FB2_8Bl Fast_C	4/4	1	140		●	:
Gtr	Pop Rock	1798	[Mg]FC2_8Bl Fast_C	4/4	1	140		●	:
Gtr	Pop Rock	1799	[Mg]FD2_8Bl Fast_C	4/4	1	140		●	:
Gtr	Pop Rock	1800	[Mg]EA2_8Bl Fast_C	4/4	5	140		●	:
Gtr	Pop Rock	1801	[Mg]MA_16Bl Med_C	4/4	4	96		●	Mega 60s ChorusCombo
Gtr	Pop Rock	1802	[Mg]MB_16Bl Med_C	4/4	4	96		●	:
Gtr	Pop Rock	1803	[Mg]MC_16Bl Med_C	4/4	4	96		●	:
Gtr	Pop Rock	1804	[Mg]MD_16Bl Med_C	4/4	4	96		●	:
Gtr	Pop Rock	1805	[Mg]FA_16Bl Med_C	4/4	1	96		●	:
Gtr	Pop Rock	1806	[Mg]FB_16Bl Med_C	4/4	1	96		●	:
Gtr	Pop Rock	1807	[Mg]FC_16Bl Med_C	4/4	1	96		●	:
Gtr	Pop Rock	1808	[Mg]FD_16Bl Med_C	4/4	1	96		●	:
Gtr	Pop Rock	1809	[Mg]EA_16Bl Med_C	4/4	4	96		●	:
Gtr	Pop Rock	1810	[Mg]MA1_GiPopMed_C	4/4	4	98		●	Mega Steel
Gtr	Pop Rock	1811	[Mg]MB1_GiPopMed_C	4/4	4	98		●	:
Gtr	Pop Rock	1812	[Mg]MC1_GiPopMed_C	4/4	4	98		●	:
Gtr	Pop Rock	1813	[Mg]MD1_GiPopMed_C	4/4	4	98		●	:
Gtr	Pop Rock	1814	[Mg]FA1_GiPopMed_C	4/4	1	98		●	:
Gtr	Pop Rock	1815	[Mg]FB1_GiPopMed_C	4/4	1	98		●	:
Gtr	Pop Rock	1816	[Mg]FC1_GiPopMed_C	4/4	1	98		●	:
Gtr	Pop Rock	1817	[Mg]FD1_GiPopMed_C	4/4	1	98		●	:
Gtr	Pop Rock	1818	[Mg]EA1_GiPopMed_C	4/4	3	98		●	:
Gtr	Pop Rock	1819	[Mg]MA2_GiPopMed_C	4/4	4	98		●	Mega 60s Tremolo
Gtr	Pop Rock	1820	[Mg]MB2_GiPopMed_C	4/4	4	98		●	:
Gtr	Pop Rock	1821	[Mg]MC2_GiPopMed_C	4/4	4	98		●	:
Gtr	Pop Rock	1822	[Mg]MD2_GiPopMed_C	4/4	4	98		●	:
Gtr	Pop Rock	1823	[Mg]FA2_GiPopMed_C	4/4	1	98		●	:
Gtr	Pop Rock	1824	[Mg]FB2_GiPopMed_C	4/4	1	98		●	:
Gtr	Pop Rock	1825	[Mg]FC2_GiPopMed_C	4/4	1	98		●	:
Gtr	Pop Rock	1826	[Mg]FD2_GiPopMed_C	4/4	1	98		●	:
Gtr	Pop Rock	1827	[Mg]EA2_GiPopMed_C	4/4	3	98		●	:

Main Category	Sub Category	ARP No.	ARP Name	Time Signature	Length	Original Tempo	Accent	Random SFX	Sound Type
Gtr	Pop Rock	1828	[Mg]MA_PopShfl1_C	4/4	4	180		●	Mega 60s Clean
Gtr	Pop Rock	1829	[Mg]MB_PopShfl1_C	4/4	4	180		●	:
Gtr	Pop Rock	1830	[Mg]MC_PopShfl1_C	4/4	4	180		●	:
Gtr	Pop Rock	1831	[Mg]MD_PopShfl1_C	4/4	4	180		●	:
Gtr	Pop Rock	1832	[Mg]FA_PopShfl1_C	4/4	1	180		●	:
Gtr	Pop Rock	1833	[Mg]FB_PopShfl1_C	4/4	1	180		●	:
Gtr	Pop Rock	1834	[Mg]FC_PopShfl1_C	4/4	1	180		●	:
Gtr	Pop Rock	1835	[Mg]FD_PopShfl1_C	4/4	1	180		●	:
Gtr	Pop Rock	1836	[Mg]EA_PopShfl1_C	4/4	5	180		●	:
Gtr	Pop Rock	1837	[Mg]MA_SwMOR Pp_C	4/4	4	94		●	Mega Nylon
Gtr	Pop Rock	1838	[Mg]MB_SwMOR Pp_C	4/4	4	94		●	:
Gtr	Pop Rock	1839	[Mg]MC_SwMOR Pp_C	4/4	4	94		●	:
Gtr	Pop Rock	1840	[Mg]MD_SwMOR Pp_C	4/4	4	94		●	:
Gtr	Pop Rock	1841	[Mg]FA_SwMOR Pp_C	4/4	1	94		●	:
Gtr	Pop Rock	1842	[Mg]FB_SwMOR Pp_C	4/4	1	94		●	:
Gtr	Pop Rock	1843	[Mg]FC_SwMOR Pp_C	4/4	1	94		●	:
Gtr	Pop Rock	1844	[Mg]FD_SwMOR Pp_C	4/4	1	94		●	:
Gtr	Pop Rock	1845	[Mg]EA_SwMOR Pp_C	4/4	3	94		●	:
Gtr	Pop Rock	1846	[Mg]MA_12/8 Pop_C	6/4	4	90		●	Mega Steel
Gtr	Pop Rock	1847	[Mg]MB_12/8 Pop_C	6/4	4	90		●	:
Gtr	Pop Rock	1848	[Mg]MC_12/8 Pop_C	6/4	4	90		●	:
Gtr	Pop Rock	1849	[Mg]MD_12/8 Pop_C	6/4	4	90		●	:
Gtr	Pop Rock	1850	[Mg]FA_12/8 Pop_C	6/4	1	90		●	:
Gtr	Pop Rock	1851	[Mg]FB_12/8 Pop_C	6/4	1	90		●	:
Gtr	Pop Rock	1852	[Mg]FC_12/8 Pop_C	6/4	1	90		●	:
Gtr	Pop Rock	1853	[Mg]FD_12/8 Pop_C	6/4	1	90		●	:
Gtr	Pop Rock	1854	[Mg]EA_12/8 Pop_C	6/4	4	90		●	:
Gtr	Pop Rock	1855	[Mg]MA1_Cntry8Bl_C	4/4	4	82		●	:
Gtr	Pop Rock	1856	[Mg]MB1_Cntry8Bl_C	4/4	4	82		●	:
Gtr	Pop Rock	1857	[Mg]MC1_Cntry8Bl_C	4/4	4	82		●	:
Gtr	Pop Rock	1858	[Mg]MD1_Cntry8Bl_C	4/4	4	82		●	:
Gtr	Pop Rock	1859	[Mg]FA1_Cntry8Bl_C	4/4	1	82		●	:
Gtr	Pop Rock	1860	[Mg]FB1_Cntry8Bl_C	4/4	1	82		●	:
Gtr	Pop Rock	1861	[Mg]FC1_Cntry8Bl_C	4/4	1	82		●	:
Gtr	Pop Rock	1862	[Mg]FD1_Cntry8Bl_C	4/4	1	82		●	:
Gtr	Pop Rock	1863	[Mg]EA1_Cntry8Bl_C	4/4	3	82		●	:
Gtr	Pop Rock	1864	[Mg]MA2_Cntry8Bl_C	4/4	4	82		●	Mega 12 Steel
Gtr	Pop Rock	1865	[Mg]MB2_Cntry8Bl_C	4/4	4	82		●	:
Gtr	Pop Rock	1866	[Mg]MC2_Cntry8Bl_C	4/4	4	82		●	:
Gtr	Pop Rock	1867	[Mg]MD2_Cntry8Bl_C	4/4	4	82		●	:
Gtr	Pop Rock	1868	[Mg]FA2_Cntry8Bl_C	4/4	1	82		●	:
Gtr	Pop Rock	1869	[Mg]FB2_Cntry8Bl_C	4/4	1	82		●	:
Gtr	Pop Rock	1870	[Mg]FC2_Cntry8Bl_C	4/4	1	82		●	:
Gtr	Pop Rock	1871	[Mg]FD2_Cntry8Bl_C	4/4	1	82		●	:
Gtr	Pop Rock	1872	[Mg]EA2_Cntry8Bl_C	4/4	3	82		●	:
Gtr	Pop Rock	1873	[Mg]MA1_CntrySwg_C	4/4	4	182		●	Mega Steel
Gtr	Pop Rock	1874	[Mg]MB1_CntrySwg_C	4/4	4	182		●	:
Gtr	Pop Rock	1875	[Mg]MC1_CntrySwg_C	4/4	4	182		●	:
Gtr	Pop Rock	1876	[Mg]MD1_CntrySwg_C	4/4	4	182		●	:
Gtr	Pop Rock	1877	[Mg]FA1_CntrySwg_C	4/4	1	182		●	:
Gtr	Pop Rock	1878	[Mg]FB1_CntrySwg_C	4/4	1	182		●	:
Gtr	Pop Rock	1879	[Mg]FC1_CntrySwg_C	4/4	1	182		●	:
Gtr	Pop Rock	1880	[Mg]FD1_CntrySwg_C	4/4	1	182		●	:
Gtr	Pop Rock	1881	[Mg]EA1_CntrySwg_C	4/4	5	182		●	:
Gtr	Pop Rock	1882	[Mg]MA2_CntrySwg_C	4/4	4	182		●	Mega 60s Blues Tone
Gtr	Pop Rock	1883	[Mg]MB2_CntrySwg_C	4/4	4	182		●	:
Gtr	Pop Rock	1884	[Mg]MC2_CntrySwg_C	4/4	4	182		●	:
Gtr	Pop Rock	1885	[Mg]MD2_CntrySwg_C	4/4	4	182		●	:
Gtr	Pop Rock	1886	[Mg]FA2_CntrySwg_C	4/4	1	182		●	:
Gtr	Pop Rock	1887	[Mg]FB2_CntrySwg_C	4/4	1	182		●	:
Gtr	Pop Rock	1888	[Mg]FC2_CntrySwg_C	4/4	1	182		●	:
Gtr	Pop Rock	1889	[Mg]FD2_CntrySwg_C	4/4	1	182		●	:
Gtr	Pop Rock	1890	[Mg]EA2_CntrySwg_C	4/4	5	182		●	:
Gtr	Pop Rock	1891	[Mg]MA_CntryWiz_C	3/4	4	144		●	Mega 12 Steel
Gtr	Pop Rock	1892	[Mg]MB_CntryWiz_C	3/4	4	144		●	:
Gtr	Pop Rock	1893	[Mg]MC_CntryWiz_C	3/4	4	144		●	:
Gtr	Pop Rock	1894	[Mg]MD_CntryWiz_C	3/4	4	144		●	:

Main Category	Sub Category	ARP No.	ARP Name	Time Signature	Length	Original Tempo	Accent	Random SFX	Sound Type
Gtr	Pop Rock	1915	[Mg]MA2_AcoustPp_C	4/4	4	110		●	Mega 60s Clean
Gtr	Pop Rock	1916	[Mg]MB2_AcoustPp_C	4/4	4	110		●	
Gtr	Pop Rock	1917	[Mg]MC2_AcoustPp_C	4/4	4	110		●	
Gtr	Pop Rock	1918	[Mg]FA2_AcoustPp_C	4/4	1	110		●	
Gtr	Pop Rock	1919	[Mg]FB2_AcoustPp_C	4/4	1	110		●	
Gtr	Pop Rock	1920	[Mg]FC2_AcoustPp_C	4/4	1	110		●	
Gtr	Pop Rock	1921	[Mg]BA1_WrshpSw_C	4/4	4	75		●	Mega Steel
Gtr	Pop Rock	1922	[Mg]MB1_WrshpSw_C	4/4	4	75		●	
Gtr	Pop Rock	1923	[Mg]MC1_WrshpSw_C	4/4	4	75		●	
Gtr	Pop Rock	1924	[Mg]FA1_WrshpSw_C	4/4	1	75		●	
Gtr	Pop Rock	1925	[Mg]FB1_WrshpSw_C	4/4	1	75		●	
Gtr	Pop Rock	1926	[Mg]FC1_WrshpSw_C	4/4	1	75		●	
Gtr	Pop Rock	1927	[Mg]BA1_WrshpMed_C	4/4	1	75		●	
Gtr	Pop Rock	1928	[Mg]EA1_WrshpSw_C	4/4	4	75		●	
Gtr	Pop Rock	1929	[Mg]EB1_WrshpSw_C	4/4	4	75		●	
Gtr	Pop Rock	1930	[Mg]MA2_WrshpMed_C	4/4	4	75		●	Mega Nylon
Gtr	Pop Rock	1931	[Mg]MB2_WrshpMed_C	4/4	4	75		●	
Gtr	Pop Rock	1932	[Mg]MC2_WrshpMed_C	4/4	4	75		●	
Gtr	Pop Rock	1933	[Mg]FA2_WrshpMed_C	4/4	1	75		●	
Gtr	Pop Rock	1934	[Mg]FB2_WrshpMed_C	4/4	1	75		●	
Gtr	Pop Rock	1935	[Mg]FC2_WrshpMed_C	4/4	1	75		●	
Gtr	Pop Rock	1936	[Mg]BA2_WrshpMed_C	4/4	1	75		●	
Gtr	Pop Rock	1937	[Mg]MA1_WrshpMed_C	4/4	8	140		●	Mega Steel
Gtr	Pop Rock	1938	[Mg]MB1_WrshpMed_C	4/4	4	140		●	
Gtr	Pop Rock	1939	[Mg]MC1_WrshpMed_C	4/4	4	140		●	
Gtr	Pop Rock	1940	[Mg]FA1_WrshpMed_C	4/4	1	140		●	
Gtr	Pop Rock	1941	[Mg]FB1_WrshpMed_C	4/4	1	140		●	
Gtr	Pop Rock	1942	[Mg]FC1_WrshpMed_C	4/4	1	140		●	
Gtr	Pop Rock	1943	[Mg]BA1_WrshpMed_C	4/4	1	140		●	
Gtr	Pop Rock	1944	[Mg]EA1_WrshpMed_C	4/4	4	140		●	
Gtr	Pop Rock	1945	[Mg]EB1_WrshpMed_C	4/4	4	140		●	
Gtr	Pop Rock	1946	[Mg]MA2_WrshpMed_C	4/4	8	140		●	Mega Nylon
Gtr	Pop Rock	1947	[Mg]MB2_WrshpMed_C	4/4	4	140		●	
Gtr	Pop Rock	1948	[Mg]MC2_WrshpMed_C	4/4	4	140		●	
Gtr	Pop Rock	1949	[Mg]FA2_WrshpMed_C	4/4	1	140		●	
Gtr	Pop Rock	1950	[Mg]FB2_WrshpMed_C	4/4	1	140		●	
Gtr	Pop Rock	1951	[Mg]FC2_WrshpMed_C	4/4	1	140		●	
Gtr	Pop Rock	1952	[Mg]BA2_WrshpMed_C	4/4	1	140		●	
Gtr	Pop Rock	1953	[Mg]EA2_WrshpMed_C	4/4	4	140		●	
Gtr	Pop Rock	1954	[Mg]EB2_WrshpMed_C	4/4	4	140		●	
Gtr	Pop Rock	1955	[Mg]MA_WrshpFast_C	4/4	8	114		●	Mega Steel
Gtr	Pop Rock	1956	[Mg]MB_WrshpFast_C	4/4	4	114		●	
Gtr	Pop Rock	1957	[Mg]MC_WrshpFast_C	4/4	4	114		●	
Gtr	Pop Rock	1958	[Mg]FA_WrshpFast_C	4/4	1	114		●	
Gtr	Pop Rock	1959	[Mg]FB_WrshpFast_C	4/4	1	114		●	
Gtr	Pop Rock	1960	[Mg]FC_WrshpFast_C	4/4	1	114		●	
Gtr	Pop Rock	1961	[Mg]BA_WrshpFast_C	4/4	1	114		●	
Gtr	Pop Rock	1962	[Mg]EA_WrshpFast_C	4/4	4	114		●	
Gtr	Pop Rock	1963	[Mg]EB_WrshpFast_C	4/4	2	114		●	
Gtr	Pop Rock	1964	[Mg]MA_New Crnry_C	4/4	2	118		●	Mega 60s Clean
Gtr	Pop Rock	1965	[Mg]MB_New Crnry_C	4/4	4	118		●	
Gtr	Pop Rock	1966	[Mg]MC_New Crnry_C	4/4	2	118		●	
Gtr	Pop Rock	1967	[Mg]FA_New Crnry_C	4/4	1	118		●	
Gtr	Pop Rock	1968	[Mg]FB_New Crnry_C	4/4	1	118		●	
Gtr	Pop Rock	1969	[Mg]FC_New Crnry_C	4/4	1	118		●	
Gtr	Pop Rock	1970	[Mg]BA_New Crnry_C	4/4	1	118		●	
Gtr	Pop Rock	1971	[Mg]EA_New Crnry_C	4/4	4	118		●	
Gtr	Pop Rock	1972	[Mg]EB_New Crnry_C	4/4	4	118		●	
Gtr	Pop Rock	1973	[Mg]MA_New Country	4/4	2	118		●	
Gtr	Pop Rock	1974	[Mg]MB_New Country	4/4	4	118		●	
Gtr	Pop Rock	1975	[Mg]MC_New Country	4/4	2	118		●	
Gtr	Pop Rock	1976	[Mg]FA_New Country	4/4	1	118		●	
Gtr	Pop Rock	1977	[Mg]FB_New Country	4/4	1	118		●	
Gtr	Pop Rock	1978	[Mg]FC_New Country	4/4	1	118		●	
Gtr	Pop Rock	1979	[Mg]BA_New Country	4/4	1	118		●	
Gtr	Pop Rock	1980	[Mg]MA1_VintgGpp_C	4/4	4	148		●	Mega Steel
Gtr	Pop Rock	1981	[Mg]MB1_VintgGpp_C	4/4	4	148		●	
Gtr	Pop Rock	1982	[Mg]MC1_VintgGpp_C	4/4	4	148		●	
Gtr	Pop Rock	1983	[Mg]FA1_VintgGpp_C	4/4	1	148		●	
Gtr	Pop Rock	1984	[Mg]FB1_VintgGpp_C	4/4	1	148		●	
Gtr	Pop Rock	1985	[Mg]FC1_VintgGpp_C	4/4	1	148		●	
Gtr	Pop Rock	1986	[Mg]BA1_VintgGpp_C	4/4	1	148		●	
Gtr	Pop Rock	1987	[Mg]EA1_VintgGpp_C	4/4	4	148		●	
Gtr	Pop Rock	1988	[Mg]EB1_VintgGpp_C	4/4	4	148		●	
Gtr	Pop Rock	1989	[Mg]MA2_VintgGpp_C	4/4	4	148		●	Mega 60s Clean
Gtr	Pop Rock	1990	[Mg]MB2_VintgGpp_C	4/4	4	148		●	
Gtr	Pop Rock	1991	[Mg]MC2_VintgGpp_C	4/4	4	148		●	
Gtr	Pop Rock	1992	[Mg]FA2_VintgGpp_C	4/4	1	148		●	
Gtr	Pop Rock	1993	[Mg]FB2_VintgGpp_C	4/4	1	148		●	
Gtr	Pop Rock	1994	[Mg]FC2_VintgGpp_C	4/4	1	148		●	
Gtr	Pop Rock	1995	[Mg]BA2_VintgGpp_C	4/4	1	148		●	
Gtr	Pop Rock	1996	[Mg]EA2_VintgGpp_C	4/4	4	148		●	
Gtr	Pop Rock	1997	[Mg]EB2_VintgGpp_C	4/4	4	148		●	
Gtr	Pop Rock	1998	[Mg]MA1_WestC.Pp_C	4/4	4	100		●	Mega Steel
Gtr	Pop Rock	1999	[Mg]MB1_WestC.Pp_C	4/4	4	100		●	
Gtr	Pop Rock	2000	[Mg]MC1_WestC.Pp_C	4/4	4	100		●	
Gtr	Pop Rock	2001	[Mg]FA1_WestC.Pp_C	4/4	1	100		●	

Main Category	Sub Category	ARP No.	ARP Name	Time Signature	Length	Original Tempo	Accent	Random SFX	Sound Type
Gtr	Pop Rock	2002	[Mg]FB1_WestC.Pp_C	4/4	1	100		●	
Gtr	Pop Rock	2003	[Mg]FC1_WestC.Pp_C	4/4	1	100		●	
Gtr	Pop Rock	2004	[Mg]BA1_WestC.Pp_C	4/4	1	100		●	
Gtr	Pop Rock	2005	[Mg]EA1_WestC.Pp_C	4/4	4	100		●	
Gtr	Pop Rock	2006	[Mg]EB1_WestC.Pp_C	4/4	4	100		●	
Gtr	Pop Rock	2007	[Mg]MA2_WestC.Pp_C	4/4	4	100		●	Mega 60s Tube Tone
Gtr	Pop Rock	2008	[Mg]MB2_WestC.Pp_C	4/4	4	100		●	
Gtr	Pop Rock	2009	[Mg]MC2_WestC.Pp_C	4/4	4	100		●	
Gtr	Pop Rock	2010	[Mg]FA2_WestC.Pp_C	4/4	1	100		●	
Gtr	Pop Rock	2011	[Mg]FB2_WestC.Pp_C	4/4	1	100		●	
Gtr	Pop Rock	2012	[Mg]FC2_WestC.Pp_C	4/4	1	100		●	
Gtr	Pop Rock	2013	[Mg]BA2_WestC.Pp_C	4/4	1	100		●	
Gtr	Pop Rock	2014	[Mg]EA2_WestC.Pp_C	4/4	4	100		●	
Gtr	Pop Rock	2015	[Mg]EB2_WestC.Pp_C	4/4	4	100		●	
Gtr	Pop Rock	2016	[Mg]MA1_Brit Pop_C	4/4	2	86		●	Mega Steel
Gtr	Pop Rock	2017	[Mg]MB1_Brit Pop_C	4/4	2	86		●	
Gtr	Pop Rock	2018	[Mg]MC1_Brit Pop_C	4/4	2	86		●	
Gtr	Pop Rock	2019	[Mg]FA1_Brit Pop_C	4/4	1	86		●	
Gtr	Pop Rock	2020	[Mg]FB1_Brit Pop_C	4/4	1	86		●	
Gtr	Pop Rock	2021	[Mg]FC1_Brit Pop_C	4/4	1	86		●	
Gtr	Pop Rock	2022	[Mg]BA1_Brit Pop_C	4/4	1	86		●	
Gtr	Pop Rock	2023	[Mg]EA1_Brit Pop_C	4/4	4	86		●	
Gtr	Pop Rock	2024	[Mg]EB1_Brit Pop_C	4/4	4	86		●	
Gtr	Pop Rock	2025	[Mg]MA1_Brit Pop	4/4	2	86		●	
Gtr	Pop Rock	2026	[Mg]MB1_Brit Pop	4/4	2	86		●	
Gtr	Pop Rock	2027	[Mg]MC1_Brit Pop	4/4	2	86		●	
Gtr	Pop Rock	2028	[Mg]FA1_Brit Pop	4/4	1	86		●	
Gtr	Pop Rock	2029	[Mg]FB1_Brit Pop	4/4	1	86		●	
Gtr	Pop Rock	2030	[Mg]FC1_Brit Pop	4/4	1	86		●	
Gtr	Pop Rock	2031	[Mg]BA1_Brit Pop	4/4	1	86		●	
Gtr	Pop Rock	2032	[Mg]MA2_Brit Pop_C	4/4	2	86		●	Mega 100l SlapClean
Gtr	Pop Rock	2033	[Mg]MB2_Brit Pop_C	4/4	2	86		●	
Gtr	Pop Rock	2034	[Mg]MC2_Brit Pop_C	4/4	2	86		●	
Gtr	Pop Rock	2035	[Mg]FA2_Brit Pop_C	4/4	1	86		●	
Gtr	Pop Rock	2036	[Mg]FB2_Brit Pop_C	4/4	1	86		●	
Gtr	Pop Rock	2037	[Mg]FC2_Brit Pop_C	4/4	1	86		●	
Gtr	Pop Rock	2038	[Mg]BA2_Brit Pop_C	4/4	1	86		●	
Gtr	Pop Rock	2039	[Mg]EA2_Brit Pop_C	4/4	4	86		●	
Gtr	Pop Rock	2040	[Mg]EB2_Brit Pop_C	4/4	4	86		●	
Gtr	Pop Rock	2041	[Mg]MA2_Brit Pop	4/4	2	86		●	
Gtr	Pop Rock	2042	[Mg]MB2_Brit Pop	4/4	2	86		●	
Gtr	Pop Rock	2043	[Mg]MC2_Brit Pop	4/4	2	86		●	
Gtr	Pop Rock	2044	[Mg]FA2_Brit Pop	4/4	1	86		●	
Gtr	Pop Rock	2045	[Mg]FB2_Brit Pop	4/4	1	86		●	
Gtr	Pop Rock	2046	[Mg]FC2_Brit Pop	4/4	1	86		●	
Gtr	Pop Rock	2047	[Mg]BA2_Brit Pop	4/4	1	86		●	
Gtr	Pop Rock	2048	[Mg]MA_BritPpSwg_C	4/4	2	110		●	Mega Steel
Gtr	Pop Rock	2049	[Mg]MB_BritPpSwg_C	4/4	2	110		●	
Gtr	Pop Rock	2050	[Mg]MC_BritPpSwg_C	4/4	2	110		●	
Gtr	Pop Rock	2051	[Mg]FA_BritPpSwg_C	4/4	1	110		●	
Gtr	Pop Rock	2052	[Mg]FB_BritPpSwg_C	4/4	1	110		●	
Gtr	Pop Rock	2053	[Mg]FC_BritPpSwg_C	4/4	1	110		●	
Gtr	Pop Rock	2054	[Mg]BA_BritPpSwg_C	4/4	1	110		●	
Gtr	Pop Rock	2055	[Mg]EA_BritPpSwg_C	4/4	4	110		●	
Gtr	Pop Rock	2056	[Mg]EB_BritPpSwg_C	4/4	4	110		●	
Gtr	Pop Rock	2057	[Mg]MA_BritPopSwing	4/4	2	110		●	
Gtr	Pop Rock	2058	[Mg]MB_BritPopSwing	4/4	2	110		●	
Gtr	Pop Rock	2059	[Mg]MC_BritPopSwing	4/4	2	110		●	
Gtr	Pop Rock	2060	[Mg]FA_BritPopSwing	4/4	1	110		●	
Gtr	Pop Rock	2061	[Mg]FB_BritPopSwing	4/4	1	110		●	
Gtr	Pop Rock	2062	[Mg]FC_BritPopSwing	4/4	1	110		●	
Gtr	Pop Rock	2063	[Mg]BA_BritPopSwing	4/4	1	110		●	
Gtr	Pop Rock	2064	[Mg]MA_Cool 8Bt_C	4/4	2	100		●	Mega 60s ChorusCombo
Gtr	Pop Rock	2065	[Mg]MB_Cool 8Bt_C	4/4	2	100		●	
Gtr	Pop Rock	2066	[Mg]MC_Cool 8Bt_C	4/4	2	100		●	
Gtr	Pop Rock	2067	[Mg]FA_Cool 8Bt_C	4/4	1	100		●	
Gtr	Pop Rock	2068	[Mg]FB_Cool 8Bt_C	4/4	1	100		●	
Gtr	Pop Rock	2069	[Mg]FC_Cool 8						

Main Category	Sub Category	ARP No.	ARP Name	Time Signature	Length	Original Tempo	Accent	Random SFX	Sound Type
Gtr	Pop Rock	2089	[Mg]MA1_80sPopRk_C	4/4	4	111		●	Mega 1coil Old R&R
Gtr	Pop Rock	2090	[Mg]MC1_80sPopRk_C	4/4	4	111		●	
Gtr	Pop Rock	2091	[Mg]MC1_80sPopRk_C	4/4	4	111		●	
Gtr	Pop Rock	2092	[Mg]FA1_80sPopRk_C	4/4	1	111		●	
Gtr	Pop Rock	2093	[Mg]FB1_80sPopRk_C	4/4	1	111		●	
Gtr	Pop Rock	2094	[Mg]FC1_80sPopRk_C	4/4	1	111		●	
Gtr	Pop Rock	2095	[Mg]BA1_80sPopRk_C	4/4	1	111		●	
Gtr	Pop Rock	2096	[Mg]EA1_80sPopRk_C	4/4	7	111		●	
Gtr	Pop Rock	2097	[Mg]MA2_80sPopRk_C	4/4	4	111		●	Mega 60s Clean
Gtr	Pop Rock	2098	[Mg]MB2_80sPopRk_C	4/4	4	111		●	
Gtr	Pop Rock	2099	[Mg]MC2_80sPopRk_C	4/4	4	111		●	
Gtr	Pop Rock	2100	[Mg]FA2_80sPopRk_C	4/4	1	111		●	
Gtr	Pop Rock	2101	[Mg]FB2_80sPopRk_C	4/4	1	111		●	
Gtr	Pop Rock	2102	[Mg]FC2_80sPopRk_C	4/4	1	111		●	
Gtr	Pop Rock	2103	[Mg]BA2_80sPopRk_C	4/4	1	111		●	
Gtr	Pop Rock	2104	[Mg]EA2_80sPopRk_C	4/4	7	111		●	
Gtr	Pop Rock	2105	[Mg]MA_80sSynthRk_C	4/4	4	96		●	Mega 1coil Old R&R
Gtr	Pop Rock	2106	[Mg]MB_80sSynthRk_C	4/4	4	96		●	
Gtr	Pop Rock	2107	[Mg]MC_80sSynthRk_C	4/4	8	96		●	
Gtr	Pop Rock	2108	[Mg]FA_80sSynthRk_C	4/4	1	96		●	
Gtr	Pop Rock	2109	[Mg]FB_80sSynthRk_C	4/4	1	96		●	
Gtr	Pop Rock	2110	[Mg]FC_80sSynthRk_C	4/4	1	96		●	
Gtr	Pop Rock	2111	[Mg]BA_80sSynthRk_C	4/4	1	96		●	
Gtr	Pop Rock	2112	[Mg]EA_80sSynthRk_C	4/4	3	96		●	
Gtr	Pop Rock	2113	[Mg]MA_60vintgPp_C	4/4	4	132		●	
Gtr	Pop Rock	2114	[Mg]MB_60vintgPp_C	4/4	4	132		●	
Gtr	Pop Rock	2115	[Mg]MC_60vintgPp_C	4/4	4	132		●	
Gtr	Pop Rock	2116	[Mg]FA_60vintgPp_C	4/4	1	132		●	
Gtr	Pop Rock	2117	[Mg]FB_60vintgPp_C	4/4	1	132		●	
Gtr	Pop Rock	2118	[Mg]FC_60vintgPp_C	4/4	1	132		●	
Gtr	Pop Rock	2119	[Mg]BA_60vintgPp_C	4/4	1	132		●	
Gtr	Pop Rock	2120	[Mg]EA_60vintgPp_C	4/4	2	132		●	
Gtr	Pop Rock	2121	[Mg]MA_60ChartSw_C	4/4	4	123		●	Mega 12 Steel
Gtr	Pop Rock	2122	[Mg]MB_60ChartSw_C	4/4	4	123		●	
Gtr	Pop Rock	2123	[Mg]MC_60ChartSw_C	4/4	4	123		●	
Gtr	Pop Rock	2124	[Mg]FA_60ChartSw_C	4/4	1	123		●	
Gtr	Pop Rock	2125	[Mg]FB_60ChartSw_C	4/4	1	123		●	
Gtr	Pop Rock	2126	[Mg]FC_60ChartSw_C	4/4	1	123		●	
Gtr	Pop Rock	2127	[Mg]BA_60ChartSw_C	4/4	1	123		●	
Gtr	Pop Rock	2128	[Mg]EA_60ChartSw_C	4/4	4	123		●	
Gtr	Ballad	2129	[Mg]MA1_88i Bld1_C	4/4	4	103		●	Mega 60s Clean
Gtr	Ballad	2130	[Mg]MB1_88i Bld1_C	4/4	4	103		●	
Gtr	Ballad	2131	[Mg]MC1_88i Bld1_C	4/4	4	103		●	
Gtr	Ballad	2132	[Mg]MD1_88i Bld1_C	4/4	4	103		●	
Gtr	Ballad	2133	[Mg]FA1_88i Bld1_C	4/4	1	103		●	
Gtr	Ballad	2134	[Mg]FB1_88i Bld1_C	4/4	1	103		●	
Gtr	Ballad	2135	[Mg]FC1_88i Bld1_C	4/4	1	103		●	
Gtr	Ballad	2136	[Mg]FD1_88i Bld1_C	4/4	1	103		●	
Gtr	Ballad	2137	[Mg]EA1_88i Bld1_C	4/4	4	103		●	
Gtr	Ballad	2138	[Mg]MA2_88i Bld1_C	4/4	4	103		●	Mega Nylon
Gtr	Ballad	2139	[Mg]MB2_88i Bld1_C	4/4	4	103		●	
Gtr	Ballad	2140	[Mg]MC2_88i Bld1_C	4/4	4	103		●	
Gtr	Ballad	2141	[Mg]MD2_88i Bld1_C	4/4	4	103		●	
Gtr	Ballad	2142	[Mg]FA2_88i Bld1_C	4/4	1	103		●	
Gtr	Ballad	2143	[Mg]FB2_88i Bld1_C	4/4	1	103		●	
Gtr	Ballad	2144	[Mg]FC2_88i Bld1_C	4/4	1	103		●	
Gtr	Ballad	2145	[Mg]FD2_88i Bld1_C	4/4	1	103		●	
Gtr	Ballad	2146	[Mg]EA2_88i Bld1_C	4/4	4	103		●	
Gtr	Ballad	2147	[Mg]MA_168i Bld1_C	4/4	4	59		●	
Gtr	Ballad	2148	[Mg]MB_168i Bld1_C	4/4	4	59		●	
Gtr	Ballad	2149	[Mg]MC_168i Bld1_C	4/4	4	59		●	
Gtr	Ballad	2150	[Mg]MD_168i Bld1_C	4/4	4	59		●	
Gtr	Ballad	2151	[Mg]FA_168i Bld1_C	4/4	1	59		●	
Gtr	Ballad	2152	[Mg]FB_168i Bld1_C	4/4	1	59		●	
Gtr	Ballad	2153	[Mg]FC_168i Bld1_C	4/4	1	59		●	
Gtr	Ballad	2154	[Mg]FD_168i Bld1_C	4/4	1	59		●	
Gtr	Ballad	2155	[Mg]EA_168i Bld1_C	4/4	3	59		●	
Gtr	Ballad	2156	[Mg]MA_12/8 Bld_C	4/4	4	60		●	Mega 60s Tremolo
Gtr	Ballad	2157	[Mg]MB_12/8 Bld_C	4/4	4	60		●	
Gtr	Ballad	2158	[Mg]MC_12/8 Bld_C	4/4	4	60		●	
Gtr	Ballad	2159	[Mg]MD_12/8 Bld_C	4/4	4	60		●	
Gtr	Ballad	2160	[Mg]FA_12/8 Bld_C	4/4	1	60		●	
Gtr	Ballad	2161	[Mg]FB_12/8 Bld_C	4/4	1	60		●	
Gtr	Ballad	2162	[Mg]FC_12/8 Bld_C	4/4	1	60		●	
Gtr	Ballad	2163	[Mg]FD_12/8 Bld_C	4/4	1	60		●	
Gtr	Ballad	2164	[Mg]EA_12/8 Bld_C	4/4	3	60		●	
Gtr	Ballad	2165	[Mg]MA1_CntryBld_C	4/4	4	75		●	Mega Steel
Gtr	Ballad	2166	[Mg]MB1_CntryBld_C	4/4	4	75		●	
Gtr	Ballad	2167	[Mg]MC1_CntryBld_C	4/4	4	75		●	
Gtr	Ballad	2168	[Mg]MD1_CntryBld_C	4/4	4	75		●	
Gtr	Ballad	2169	[Mg]FA1_CntryBld_C	4/4	1	75		●	
Gtr	Ballad	2170	[Mg]FB1_CntryBld_C	4/4	1	75		●	
Gtr	Ballad	2171	[Mg]FC1_CntryBld_C	4/4	1	75		●	
Gtr	Ballad	2172	[Mg]FD1_CntryBld_C	4/4	1	75		●	
Gtr	Ballad	2173	[Mg]EA1_CntryBld_C	4/4	3	75		●	
Gtr	Ballad	2174	[Mg]MA2_CntryBld_C	4/4	4	75		●	Mega 1coil Tremolo
Gtr	Ballad	2175	[Mg]MB2_CntryBld_C	4/4	4	75		●	

Main Category	Sub Category	ARP No.	ARP Name	Time Signature	Length	Original Tempo	Accent	Random SFX	Sound Type
Gtr	Ballad	2176	[Mg]MC2_CntryBld_C	4/4	4	75		●	
Gtr	Ballad	2177	[Mg]MD2_CntryBld_C	4/4	4	75		●	
Gtr	Ballad	2178	[Mg]FA2_CntryBld_C	4/4	1	75		●	
Gtr	Ballad	2179	[Mg]FB2_CntryBld_C	4/4	1	75		●	
Gtr	Ballad	2180	[Mg]FC2_CntryBld_C	4/4	1	75		●	
Gtr	Ballad	2181	[Mg]FD2_CntryBld_C	4/4	1	75		●	
Gtr	Ballad	2182	[Mg]EA2_CntryBld_C	4/4	3	75		●	
Gtr	Ballad	2183	[Mg]MA1_AnthrRkBd_C	4/4	4	72		●	Mega Steel
Gtr	Ballad	2184	[Mg]MB1_AnthrRkBd_C	4/4	4	72		●	
Gtr	Ballad	2185	[Mg]MC1_AnthrRkBd_C	4/4	4	72		●	
Gtr	Ballad	2186	[Mg]MD1_AnthrRkBd_C	4/4	4	72		●	
Gtr	Ballad	2187	[Mg]FA1_AnthrRkBd_C	4/4	1	72		●	
Gtr	Ballad	2188	[Mg]FB1_AnthrRkBd_C	4/4	1	72		●	
Gtr	Ballad	2189	[Mg]FC1_AnthrRkBd_C	4/4	1	72		●	
Gtr	Ballad	2190	[Mg]FD1_AnthrRkBd_C	4/4	1	72		●	
Gtr	Ballad	2191	[Mg]EA1_AnthrRkBd_C	4/4	3	72		●	
Gtr	Ballad	2192	[Mg]MA2_AnthrRkBd_C	4/4	4	72		●	Mega 60s Clean
Gtr	Ballad	2193	[Mg]MB2_AnthrRkBd_C	4/4	4	72		●	
Gtr	Ballad	2194	[Mg]MC2_AnthrRkBd_C	4/4	4	72		●	
Gtr	Ballad	2195	[Mg]MD2_AnthrRkBd_C	4/4	4	72		●	
Gtr	Ballad	2196	[Mg]FA2_AnthrRkBd_C	4/4	1	72		●	
Gtr	Ballad	2197	[Mg]FB2_AnthrRkBd_C	4/4	1	72		●	
Gtr	Ballad	2198	[Mg]FC2_AnthrRkBd_C	4/4	1	72		●	
Gtr	Ballad	2199	[Mg]FD2_AnthrRkBd_C	4/4	1	72		●	
Gtr	Ballad	2200	[Mg]EA2_AnthrRkBd_C	4/4	3	72		●	
Gtr	Ballad	2201	[Mg]MA_ElectBld_C	4/4	4	84		●	Mega Nylon
Gtr	Ballad	2202	[Mg]MB_ElectBld_C	4/4	4	84		●	
Gtr	Ballad	2203	[Mg]MC_ElectBld_C	4/4	4	84		●	
Gtr	Ballad	2204	[Mg]MD_ElectBld_C	4/4	4	84		●	
Gtr	Ballad	2205	[Mg]FA_ElectBld_C	4/4	1	84		●	
Gtr	Ballad	2206	[Mg]FB_ElectBld_C	4/4	1	84		●	
Gtr	Ballad	2207	[Mg]FC_ElectBld_C	4/4	1	84		●	
Gtr	Ballad	2208	[Mg]FD_ElectBld_C	4/4	1	84		●	
Gtr	Ballad	2209	[Mg]EA_ElectBld_C	4/4	4	84		●	
Gtr	Ballad	2210	[Mg]MA1_GtBallad_C	4/4	8	94		●	Mega Steel
Gtr	Ballad	2211	[Mg]MB1_GtBallad_C	4/4	8	94		●	
Gtr	Ballad	2212	[Mg]MC1_GtBallad_C	4/4	8	94		●	
Gtr	Ballad	2213	[Mg]MD1_GtBallad_C	4/4	1	94		●	
Gtr	Ballad	2214	[Mg]FA1_GtBallad_C	4/4	1	94		●	
Gtr	Ballad	2215	[Mg]FB1_GtBallad_C	4/4	1	94		●	
Gtr	Ballad	2216	[Mg]FC1_GtBallad_C	4/4	1	94		●	
Gtr	Ballad	2217	[Mg]FD1_GtBallad_C	4/4	1	94		●	
Gtr	Ballad	2218	[Mg]EA1_GtBallad_C	4/4	4	94		●	
Gtr	Ballad	2219	[Mg]MA1_GtBallad_C	4/4	8	94		●	
Gtr	Ballad	2220	[Mg]MB1_GtBallad_C	4/4	8	94		●	
Gtr	Ballad	2221	[Mg]MC1_GtBallad_C	4/4	8	94		●	
Gtr	Ballad	2222	[Mg]MD1_GtBallad_C	4/4	1	94		●	
Gtr	Ballad	2223	[Mg]FA1_GtBallad_C	4/4	1	94		●	
Gtr	Ballad	2224	[Mg]FB1_GtBallad_C	4/4	1	94		●	
Gtr	Ballad	2225	[Mg]FC1_GtBallad_C	4/4	1	94		●	
Gtr	Ballad	2226	[Mg]FD1_GtBallad_C	4/4	1	94		●	
Gtr	Ballad	2227	[Mg]EA1_GtBallad_C	4/4	8	94		●	Mega Nylon
Gtr	Ballad	2228	[Mg]MA2_GtBallad_C	4/4	8	94		●	
Gtr	Ballad	2229	[Mg]MB2_GtBallad_C	4/4	8	94		●	
Gtr	Ballad	2230	[Mg]MC2_GtBallad_C	4/4	8	94		●	
Gtr	Ballad	2231	[Mg]MD2_GtBallad_C	4/4	1	94		●	
Gtr	Ballad	2232	[Mg]FA2_GtBallad_C	4/4	1	94		●	
Gtr	Ballad	2233	[Mg]FB2_GtBallad_C	4/4	1	94		●	
Gtr	Ballad	2234	[Mg]FC2_GtBallad_C	4/4	1	94		●	
Gtr	Ballad	2235	[Mg]FD2_GtBallad_C	4/4	1	94		●	
Gtr	Ballad	2236	[Mg]EA2_GtBallad_C	4/4	4	94		●	
Gtr	Ballad	2237	[Mg]MA2_GtBallad_C	4/4	8	94		●	
Gtr	Ballad	2238	[Mg]MB2_GtBallad_C	4/4	8	94		●	
Gtr	Ballad	2239	[Mg]MC2_GtBallad_C	4/4	8	94		●	
Gtr	Ballad	2240	[Mg]MD2_GtBallad_C	4/4	1	94		●	

Main Category	Sub Category	ARP No.	ARP Name	Time Signature	Length	Original Tempo	Accent	Random SFX	Sound Type
Gtr	Ballad	2263	[Mg]EA_Unplugged2_C	4/4	5	120		•	:
Gtr	Ballad	2264	[Mg]EB_Unplugged2_C	4/4	4	120		•	:
Gtr	Ballad	2265	[Mg]MA_Unplugged 2	4/4	8	120		•	:
Gtr	Ballad	2266	[Mg]MB_Unplugged 2	4/4	8	120		•	:
Gtr	Ballad	2267	[Mg]MC_Unplugged 2	4/4	8	120		•	:
Gtr	Ballad	2268	[Mg]FA_Unplugged 2	4/4	1	120		•	:
Gtr	Ballad	2269	[Mg]FB_Unplugged 2	4/4	1	120		•	:
Gtr	Ballad	2270	[Mg]FC_Unplugged 2	4/4	1	120		•	:
Gtr	Ballad	2271	[Mg]BA_Unplugged 2	4/4	1	120		•	:
Gtr	Ballad	2272	[Mg]MA_EP Ballad_C	4/4	2	60		•	Mega 1coil Slap/Clean
Gtr	Ballad	2273	[Mg]MB_EP Ballad_C	4/4	2	60		•	:
Gtr	Ballad	2274	[Mg]MC_EP Ballad_C	4/4	2	60		•	:
Gtr	Ballad	2275	[Mg]FA_EP Ballad_C	4/4	1	60		•	:
Gtr	Ballad	2276	[Mg]FB_EP Ballad_C	4/4	1	60		•	:
Gtr	Ballad	2277	[Mg]FC_EP Ballad_C	4/4	1	60		•	:
Gtr	Ballad	2278	[Mg]BA_EP Ballad_C	4/4	1	60		•	:
Gtr	Ballad	2279	[Mg]EA_EP Ballad_C	4/4	4	60		•	:
Gtr	Ballad	2280	[Mg]EB_EP Ballad_C	4/4	4	60		•	:
Gtr	Hip Hop	2281	[Mg]MA_Dancehall_C	4/4	4	103		•	Mega 1coil Old R&R
Gtr	Hip Hop	2282	[Mg]MB_Dancehall_C	4/4	4	103		•	:
Gtr	Hip Hop	2283	[Mg]MD_Dancehall_C	4/4	4	103		•	:
Gtr	Hip Hop	2284	[Mg]FA_Dancehall_C	4/4	1	103		•	:
Gtr	Hip Hop	2285	[Mg]FB_Dancehall_C	4/4	1	103		•	:
Gtr	Hip Hop	2286	[Mg]FD_Dancehall_C	4/4	1	103		•	:
Gtr	Hip Hop	2287	[Mg]BA_Dancehall_C	4/4	1	103		•	:
Gtr	Hip Hop	2288	[Mg]EA_Dancehall_C	4/4	3	103		•	:
Gtr	Modern R&B	2289	[Mg]MA_NeoUKSoul_C	4/4	4	79		•	Mega Steel
Gtr	Modern R&B	2290	[Mg]MB_NeoUKSoul_C	4/4	4	79		•	:
Gtr	Modern R&B	2291	[Mg]MC_NeoUKSoul_C	4/4	4	79		•	:
Gtr	Modern R&B	2292	[Mg]MD_NeoUKSoul_C	4/4	4	79		•	:
Gtr	Modern R&B	2293	[Mg]FA_NeoUKSoul_C	4/4	1	79		•	:
Gtr	Modern R&B	2294	[Mg]FB_NeoUKSoul_C	4/4	1	79		•	:
Gtr	Modern R&B	2295	[Mg]FC_NeoUKSoul_C	4/4	1	79		•	:
Gtr	Modern R&B	2296	[Mg]FD_NeoUKSoul_C	4/4	1	79		•	:
Gtr	Modern R&B	2297	[Mg]EA_NeoUKSoul_C	4/4	3	79		•	:
Gtr	Modern R&B	2298	[Mg]MA_Slow&Easy_C	4/4	4	72		•	Mega 60s Clean
Gtr	Modern R&B	2299	[Mg]MB_Slow&Easy_C	4/4	4	72		•	:
Gtr	Modern R&B	2300	[Mg]MC_Slow&Easy_C	4/4	4	72		•	:
Gtr	Modern R&B	2301	[Mg]MD_Slow&Easy_C	4/4	1	72		•	:
Gtr	Modern R&B	2302	[Mg]FA_Slow&Easy_C	4/4	1	72		•	:
Gtr	Modern R&B	2303	[Mg]FB_Slow&Easy_C	4/4	1	72		•	:
Gtr	Modern R&B	2304	[Mg]BA_Slow&Easy_C	4/4	1	72		•	:
Gtr	Modern R&B	2305	[Mg]EA_Slow&Easy_C	4/4	3	72		•	:
Gtr	Modern R&B	2306	[Mg]EB_Slow&Easy_C	4/4	4	72		•	:
Gtr	Modern R&B	2307	[Mg]MA_R&B_C	4/4	2	83		•	Mega 60s Tube Tone
Gtr	Modern R&B	2308	[Mg]MB_R&B_C	4/4	2	83		•	:
Gtr	Modern R&B	2309	[Mg]MC_R&B_C	4/4	2	83		•	:
Gtr	Modern R&B	2310	[Mg]FA_R&B_C	4/4	1	83		•	:
Gtr	Modern R&B	2311	[Mg]FB_R&B_C	4/4	1	83		•	:
Gtr	Modern R&B	2312	[Mg]FC_R&B_C	4/4	1	83		•	:
Gtr	Modern R&B	2313	[Mg]BA_R&B_C	4/4	1	83		•	:
Gtr	Modern R&B	2314	[Mg]EA_R&B_C	4/4	4	83		•	:
Gtr	Modern R&B	2315	[Mg]EB_R&B_C	4/4	4	83		•	:
Gtr	Modern R&B	2316	[Mg]MA_New R&B 1_C	4/4	2	98		•	Mega Steel
Gtr	Modern R&B	2317	[Mg]MB_New R&B 1_C	4/4	2	98		•	:
Gtr	Modern R&B	2318	[Mg]MC_New R&B 1_C	4/4	2	98		•	:
Gtr	Modern R&B	2319	[Mg]FA_New R&B 1_C	4/4	1	98		•	:
Gtr	Modern R&B	2320	[Mg]FB_New R&B 1_C	4/4	1	98		•	:
Gtr	Modern R&B	2321	[Mg]FC_New R&B 1_C	4/4	1	98		•	:
Gtr	Modern R&B	2322	[Mg]BA_New R&B 1_C	4/4	1	98		•	:
Gtr	Modern R&B	2323	[Mg]EA_New R&B 1_C	4/4	3	98		•	:
Gtr	Modern R&B	2324	[Mg]EB_New R&B 1_C	4/4	4	98		•	:
Gtr	Modern R&B	2325	[Mg]MA_R&B Bld1_C	4/4	4	70		•	Mega 60s Slap Clean
Gtr	Modern R&B	2326	[Mg]MB_R&B Bld1_C	4/4	4	70		•	:
Gtr	Modern R&B	2327	[Mg]MC_R&B Bld1_C	4/4	4	70		•	:
Gtr	Modern R&B	2328	[Mg]FA_R&B Bld1_C	4/4	1	70		•	:
Gtr	Modern R&B	2329	[Mg]FB_R&B Bld1_C	4/4	1	70		•	:
Gtr	Modern R&B	2330	[Mg]FC_R&B Bld1_C	4/4	1	70		•	:
Gtr	Modern R&B	2331	[Mg]BA_R&B Bld1_C	4/4	1	70		•	:
Gtr	Classic R&B	2332	[Mg]MA_SndrdDsc_C	4/4	4	120		•	Mega 60s Clean
Gtr	Classic R&B	2333	[Mg]MB_SndrdDsc_C	4/4	4	120		•	:
Gtr	Classic R&B	2334	[Mg]MC_SndrdDsc_C	4/4	4	120		•	:
Gtr	Classic R&B	2335	[Mg]FA_SndrdDsc_C	4/4	1	120		•	:
Gtr	Classic R&B	2336	[Mg]FB_SndrdDsc_C	4/4	1	120		•	:
Gtr	Classic R&B	2337	[Mg]FC_SndrdDsc_C	4/4	1	120		•	:
Gtr	Classic R&B	2338	[Mg]BA_SndrdDsc_C	4/4	1	120		•	:
Gtr	Classic R&B	2339	[Mg]EA_SndrdDsc_C	4/4	3	120		•	:
Gtr	Classic R&B	2340	[Mg]EB_SndrdDsc_C	4/4	3	120		•	:
Gtr	Classic R&B	2341	[Mg]MA_Retro Dsc_C	4/4	4	108		•	Mega1coilSlapPedalWah
Gtr	Classic R&B	2342	[Mg]MB_Retro Dsc_C	4/4	4	108		•	:
Gtr	Classic R&B	2343	[Mg]MC_Retro Dsc_C	4/4	4	108		•	:
Gtr	Classic R&B	2344	[Mg]FA_Retro Dsc_C	4/4	1	108		•	:
Gtr	Classic R&B	2345	[Mg]FB_Retro Dsc_C	4/4	1	108		•	:
Gtr	Classic R&B	2346	[Mg]FC_Retro Dsc_C	4/4	1	108		•	:
Gtr	Classic R&B	2347	[Mg]BA_Retro Dsc_C	4/4	1	108		•	:
Gtr	Classic R&B	2348	[Mg]EA_Retro Dsc_C	4/4	4	108		•	:
Gtr	Classic R&B	2349	[Mg]EB_Retro Dsc_C	4/4	4	108		•	:

Main Category	Sub Category	ARP No.	ARP Name	Time Signature	Length	Original Tempo	Accent	Random SFX	Sound Type
Gtr	Classic R&B	2350	[Mg]MA_70CoolDsc_C	4/4	4	114		•	Mega 60s ChorusCombo
Gtr	Classic R&B	2351	[Mg]MB_70CoolDsc_C	4/4	4	114		•	:
Gtr	Classic R&B	2352	[Mg]MC_70CoolDsc_C	4/4	4	114		•	:
Gtr	Classic R&B	2353	[Mg]FA_70CoolDsc_C	4/4	1	114		•	:
Gtr	Classic R&B	2354	[Mg]FB_70CoolDsc_C	4/4	1	114		•	:
Gtr	Classic R&B	2355	[Mg]FC_70CoolDsc_C	4/4	1	114		•	:
Gtr	Classic R&B	2356	[Mg]BA_70CoolDsc_C	4/4	1	114		•	:
Gtr	Classic R&B	2357	[Mg]EA_70CoolDsc_C	4/4	4	114		•	:
Gtr	Classic R&B	2358	[Mg]EB_70CoolDsc_C	4/4	3	114		•	:
Gtr	Classic R&B	2359	[Mg]MA_Philly_C	4/4	2	100		•	Mega 60s Pedal Wah
Gtr	Classic R&B	2360	[Mg]MB_Philly_C	4/4	2	100		•	:
Gtr	Classic R&B	2361	[Mg]MC_Philly_C	4/4	2	100		•	:
Gtr	Classic R&B	2362	[Mg]FA_Philly_C	4/4	1	100		•	:
Gtr	Classic R&B	2363	[Mg]FB_Philly_C	4/4	1	100		•	:
Gtr	Classic R&B	2364	[Mg]FC_Philly_C	4/4	1	100		•	:
Gtr	Classic R&B	2365	[Mg]BA_Philly_C	4/4	1	100		•	:
Gtr	Classic R&B	2366	[Mg]MA_Philly	4/4	2	100		•	:
Gtr	Classic R&B	2367	[Mg]MB_Philly	4/4	2	100		•	:
Gtr	Classic R&B	2368	[Mg]MC_Philly	4/4	2	100		•	:
Gtr	Classic R&B	2369	[Mg]FA_Philly	4/4	1	100		•	:
Gtr	Classic R&B	2370	[Mg]FB_Philly	4/4	1	100		•	:
Gtr	Classic R&B	2371	[Mg]FC_Philly	4/4	1	100		•	:
Gtr	Classic R&B	2372	[Mg]BA_Philly	4/4	1	100		•	:
Gtr	Classic R&B	2373	[Mg]EA_Philly_C	4/4	4	100		•	:
Gtr	Classic R&B	2374	[Mg]EB_Philly_C	4/4	3	100		•	:
Gtr	Classic R&B	2375	[Mg]MA_Soul 1_C	4/4	2	116		•	Mega 1coil Slap Dist
Gtr	Classic R&B	2376	[Mg]MB_Soul 1_C	4/4	2	116		•	:
Gtr	Classic R&B	2377	[Mg]MC_Soul 1_C	4/4	2	116		•	:
Gtr	Classic R&B	2378	[Mg]FA_Soul 1_C	4/4	1	116		•	:
Gtr	Classic R&B	2379	[Mg]FB_Soul 1_C	4/4	1	116		•	:
Gtr	Classic R&B	2380	[Mg]FC_Soul 1_C	4/4	1	116		•	:
Gtr	Classic R&B	2381	[Mg]BA_Soul 1_C	4/4	1	116		•	:
Gtr	Classic R&B	2382	[Mg]EA_Soul 1_C	4/4	4	116		•	:
Gtr	Classic R&B	2383	[Mg]EB_Soul 1_C	4/4	3	116		•	:
Gtr	Classic R&B	2384	[Mg]MA_70ChrSoul_C	4/4	2	108		•	Mega 60s ChorusCombo
Gtr	Classic R&B	2385	[Mg]MB_70ChrSoul_C	4/4	2	108		•	:
Gtr	Classic R&B	2386	[Mg]MC_70ChrSoul_C	4/4	2	108		•	:
Gtr	Classic R&B	2387	[Mg]FA_70ChrSoul_C	4/4	1	108		•	:
Gtr	Classic R&B	2388	[Mg]FB_70ChrSoul_C	4/4	1	108		•	:
Gtr	Classic R&B	2389	[Mg]FC_70ChrSoul_C	4/4	1	108		•	:
Gtr	Classic R&B	2390	[Mg]BA_70ChrSoul_C	4/4	1	108		•	:
Gtr	Classic R&B	2391	[Mg]EA_70ChrSoul_C	4/4	5	108		•	:
Gtr	Classic R&B	2392	[Mg]EB_70ChrSoul_C	4/4	3	108		•	:
Gtr	Classic R&B	2393	[Mg]MA_FrankSoul_C	4/4	4	120		•	Mega 60s Clean
Gtr	Classic R&B	2394	[Mg]MB_FrankSoul_C	4/4	4	120		•	:
Gtr	Classic R&B	2395	[Mg]MC_FrankSoul_C	4/4	4	120		•	:
Gtr	Classic R&B	2396	[Mg]FA_FrankSoul_C	4/4	1	120		•	:
Gtr	Classic R&B	2397	[Mg]FB_FrankSoul_C	4/4	1	120		•	:
Gtr	Classic R&B	2398	[Mg]FC_FrankSoul_C	4/4	1	120		•	:
Gtr	Classic R&B	2399	[Mg]BA_FrankSoul_C	4/4	1	120		•	:
Gtr	Classic R&B	2400	[Mg]MA_Frankly Soul	4/4	4	120		•	:
Gtr	Classic R&B	2401	[Mg]MB_Frankly Soul	4/4	4	120		•	:
Gtr	Classic R&B	2402	[Mg]MC_Frankly Soul	4/4	4	120		•	:
Gtr	Classic R&B	2403	[Mg]FA_Frankly Soul	4/4	1	120		•	:
Gtr	Classic R&B	2404	[Mg]FB_Frankly Soul	4/4	1	120		•	:
Gtr	Classic R&B	2405	[Mg]FC_Frankly Soul	4/4	1	120		•	:
Gtr	Classic R&B	2406	[Mg]BA_Frankly Soul	4/4	1	120		•	:
Gtr	Classic R&B	2407	[Mg]EA_FrankSoul_C	4/4	3	120		•	:
Gtr	Classic R&B	2408	[Mg]EB_FrankSoul_C	4/4	4	120		•	:
Gtr	Classic R&B	2409	[Mg]MA_Soul Beat_C	4/4	4	124		•	:
Gtr	Classic R&B	2410	[Mg]MB_Soul Beat_C	4/4	4	124		•	:
Gtr	Classic R&B	2411	[Mg]MC_Soul Beat_C	4/4	4	124		•	:
Gtr	Classic R&B	2412	[Mg]FA_Soul Beat_C	4/4	1	124		•	:
Gtr	Classic R&B	2413	[Mg]FB_Soul Beat_C	4/4	1				

Arpeggio Type List

Main Category	Sub Category	ARP No.	ARP Name	Time Signature	Length	Original Tempo	Accent	Random SFX	Sound Type
Gtr	Classic R&B	2436	[Mg]FB_SoulShuff_C	4 / 4	1	98		•	:
Gtr	Classic R&B	2437	[Mg]FC_SoulShuff_C	4 / 4	1	98		•	:
Gtr	Classic R&B	2438	[Mg]BA_SoulShuff_C	4 / 4	1	98		•	:
Gtr	Classic R&B	2439	[Mg]EA_SoulShuff_C	4 / 4	3	98		•	:
Gtr	Classic R&B	2440	[Mg]EB_SoulShuff_C	4 / 4	3	98		•	:
Gtr	Classic R&B	2441	[Mg]MA_SoulSwing_C	4 / 4	4	124		•	:
Gtr	Classic R&B	2442	[Mg]MB_SoulSwing_C	4 / 4	4	124		•	:
Gtr	Classic R&B	2443	[Mg]MC_SoulSwing_C	4 / 4	4	124		•	:
Gtr	Classic R&B	2444	[Mg]FA_SoulSwing_C	4 / 4	1	124		•	:
Gtr	Classic R&B	2445	[Mg]FB_SoulSwing_C	4 / 4	1	124		•	:
Gtr	Classic R&B	2446	[Mg]FC_SoulSwing_C	4 / 4	1	124		•	:
Gtr	Classic R&B	2447	[Mg]BA_SoulSwing_C	4 / 4	1	124		•	:
Gtr	Classic R&B	2448	[Mg]EA_SoulSwing_C	4 / 4	3	123		•	:
Gtr	Classic R&B	2449	[Mg]EB_SoulSwing_C	4 / 4	5	123		•	:
Gtr	Classic R&B	2450	[Mg]MA_Gospel Br_C	4 / 4	4	108		•	Mega 60s ChorusCombo
Gtr	Classic R&B	2451	[Mg]MB_Gospel Br_C	4 / 4	4	108		•	:
Gtr	Classic R&B	2452	[Mg]MC_Gospel Br_C	4 / 4	4	108		•	:
Gtr	Classic R&B	2453	[Mg]FA_Gospel Br_C	4 / 4	1	108		•	:
Gtr	Classic R&B	2454	[Mg]FB_Gospel Br_C	4 / 4	1	108		•	:
Gtr	Classic R&B	2455	[Mg]FC_Gospel Br_C	4 / 4	1	108		•	:
Gtr	Classic R&B	2456	[Mg]BA_Gospel Br_C	4 / 4	1	108		•	:
Gtr	Classic R&B	2457	[Mg]EA_Gospel Br_C	4 / 4	4	108		•	:
Gtr	Classic R&B	2458	[Mg]EB_Gospel Br_C	4 / 4	3	108		•	:
Gtr	Funk	2459	[Mg]MA_UrbanFunk_C	4 / 4	4	115		•	Mega 60s Clean
Gtr	Funk	2460	[Mg]MB_UrbanFunk_C	4 / 4	4	115		•	:
Gtr	Funk	2461	[Mg]MC_UrbanFunk_C	4 / 4	4	115		•	:
Gtr	Funk	2462	[Mg]FA_UrbanFunk_C	4 / 4	4	115		•	:
Gtr	Funk	2463	[Mg]FB_UrbanFunk_C	4 / 4	1	115		•	:
Gtr	Funk	2464	[Mg]FC_UrbanFunk_C	4 / 4	1	115		•	:
Gtr	Funk	2465	[Mg]BA_UrbanFunk_C	4 / 4	1	115		•	:
Gtr	Funk	2466	[Mg]EA_UrbanFunk_C	4 / 4	5	115		•	:
Gtr	Funk	2467	[Mg]MA_Funk 1_C	4 / 4	8	104		•	Mega 1coil SlapClean
Gtr	Funk	2468	[Mg]MB_Funk 1_C	4 / 4	8	104		•	:
Gtr	Funk	2469	[Mg]MC_Funk 1_C	4 / 4	8	104		•	:
Gtr	Funk	2470	[Mg]FA_Funk 1_C	4 / 4	1	104		•	:
Gtr	Funk	2471	[Mg]FB_Funk 1_C	4 / 4	1	104		•	:
Gtr	Funk	2472	[Mg]FC_Funk 1_C	4 / 4	1	104		•	:
Gtr	Funk	2473	[Mg]BA_Funk 1_C	4 / 4	1	104		•	:
Gtr	Funk	2474	[Mg]EA_Funk 1_C	4 / 4	9	104		•	:
Gtr	Funk	2475	[Mg]EB_Funk 1_C	4 / 4	4	104		•	:
Gtr	Funk	2476	[Mg]MA1_FunkPpRk_C	4 / 4	4	95		•	Mega 60s Clean
Gtr	Funk	2477	[Mg]MB1_FunkPpRk_C	4 / 4	4	95		•	:
Gtr	Funk	2478	[Mg]MC1_FunkPpRk_C	4 / 4	4	95		•	:
Gtr	Funk	2479	[Mg]FA1_FunkPpRk_C	4 / 4	1	95		•	:
Gtr	Funk	2480	[Mg]FB1_FunkPpRk_C	4 / 4	1	95		•	:
Gtr	Funk	2481	[Mg]FC1_FunkPpRk_C	4 / 4	1	95		•	:
Gtr	Funk	2482	[Mg]BA1_FunkPpRk_C	4 / 4	1	95		•	:
Gtr	Funk	2483	[Mg]EA1_FunkPpRk_C	4 / 4	4	94		•	:
Gtr	Funk	2484	[Mg]EB1_FunkPpRk_C	4 / 4	3	94		•	:
Gtr	Funk	2485	[Mg]MA1_FunkPpRk	4 / 4	4	94		•	:
Gtr	Funk	2486	[Mg]MB1_FunkPpRk	4 / 4	4	94		•	:
Gtr	Funk	2487	[Mg]MC1_FunkPpRk	4 / 4	4	94		•	:
Gtr	Funk	2488	[Mg]FA1_FunkPpRk	4 / 4	1	94		•	:
Gtr	Funk	2489	[Mg]FB1_FunkPpRk	4 / 4	1	94		•	:
Gtr	Funk	2490	[Mg]FC1_FunkPpRk	4 / 4	1	94		•	:
Gtr	Funk	2491	[Mg]BA1_FunkPpRk	4 / 4	1	94		•	:
Gtr	Funk	2492	[Mg]MA2_FunkPpRk_C	4 / 4	4	95		•	Mega 1coil Slap Dist
Gtr	Funk	2493	[Mg]MB2_FunkPpRk_C	4 / 4	4	95		•	:
Gtr	Funk	2494	[Mg]MC2_FunkPpRk_C	4 / 4	4	95		•	:
Gtr	Funk	2495	[Mg]FA2_FunkPpRk_C	4 / 4	1	95		•	:
Gtr	Funk	2496	[Mg]FB2_FunkPpRk_C	4 / 4	1	95		•	:
Gtr	Funk	2497	[Mg]FC2_FunkPpRk_C	4 / 4	1	95		•	:
Gtr	Funk	2498	[Mg]BA2_FunkPpRk_C	4 / 4	1	95		•	:
Gtr	Funk	2499	[Mg]MA2_FunkPpRk	4 / 4	4	94		•	:
Gtr	Funk	2500	[Mg]MB2_FunkPpRk	4 / 4	4	94		•	:
Gtr	Funk	2501	[Mg]MC2_FunkPpRk	4 / 4	4	94		•	:
Gtr	Funk	2502	[Mg]FA2_FunkPpRk	4 / 4	1	94		•	:
Gtr	Funk	2503	[Mg]FB2_FunkPpRk	4 / 4	1	94		•	:
Gtr	Funk	2504	[Mg]FC2_FunkPpRk	4 / 4	1	94		•	:
Gtr	Funk	2505	[Mg]BA2_FunkPpRk	4 / 4	1	94		•	:
Gtr	Funk	2506	[Mg]MA_JazzFunk1_C	4 / 4	4	120		•	Mega 60s Clean
Gtr	Funk	2507	[Mg]MB_JazzFunk1_C	4 / 4	4	120		•	:
Gtr	Funk	2508	[Mg]MC_JazzFunk1_C	4 / 4	4	120		•	:
Gtr	Funk	2509	[Mg]FA_JazzFunk1_C	4 / 4	1	120		•	:
Gtr	Funk	2510	[Mg]FB_JazzFunk1_C	4 / 4	1	120		•	:
Gtr	Funk	2511	[Mg]FC_JazzFunk1_C	4 / 4	1	120		•	:
Gtr	Funk	2512	[Mg]BA_JazzFunk1_C	4 / 4	1	120		•	:
Gtr	Funk	2513	[Mg]EA_JazzFunk1_C	4 / 4	3	120		•	:
Gtr	Funk	2514	[Mg]EB_JazzFunk1_C	4 / 4	3	120		•	:
Gtr	Funk	2515	[Mg]MA_Jazz Funk 1	4 / 4	4	120		•	:
Gtr	Funk	2516	[Mg]MB_Jazz Funk 1	4 / 4	4	120		•	:
Gtr	Funk	2517	[Mg]MC_Jazz Funk 1	4 / 4	4	120		•	:
Gtr	Funk	2518	[Mg]FA_Jazz Funk 1	4 / 4	1	120		•	:
Gtr	Funk	2519	[Mg]FB_Jazz Funk 1	4 / 4	1	120		•	:
Gtr	Funk	2520	[Mg]FC_Jazz Funk 1	4 / 4	1	120		•	:
Gtr	Funk	2521	[Mg]BA_Jazz Funk 1	4 / 4	1	120		•	:
Gtr	Funk	2522	[Mg]MA_Jazz Pop_C	4 / 4	2	102		•	Mega 60s ChorusCombo

Main Category	Sub Category	ARP No.	ARP Name	Time Signature	Length	Original Tempo	Accent	Random SFX	Sound Type
Gtr	Funk	2523	[Mg]MB_Jazz Pop_C	4 / 4	2	102		•	:
Gtr	Funk	2524	[Mg]MC_Jazz Pop_C	4 / 4	2	102		•	:
Gtr	Funk	2525	[Mg]FA_Jazz Pop_C	4 / 4	1	102		•	:
Gtr	Funk	2526	[Mg]FB_Jazz Pop_C	4 / 4	1	102		•	:
Gtr	Funk	2527	[Mg]FC_Jazz Pop_C	4 / 4	1	102		•	:
Gtr	Funk	2528	[Mg]BA_Jazz Pop_C	4 / 4	1	102		•	:
Gtr	Funk	2529	[Mg]EA_Jazz Pop_C	4 / 4	2	102		•	:
Gtr	Funk	2530	[Mg]MB_Jazz Pop	4 / 4	2	102		•	:
Gtr	Funk	2531	[Mg]MC_Jazz Pop	4 / 4	2	102		•	:
Gtr	Funk	2532	[Mg]FA_Jazz Pop	4 / 4	1	102		•	:
Gtr	Funk	2533	[Mg]FB_Jazz Pop	4 / 4	1	102		•	:
Gtr	Funk	2534	[Mg]FC_Jazz Pop	4 / 4	1	102		•	:
Gtr	Funk	2535	[Mg]BA_Jazz Pop	4 / 4	1	102		•	:
Gtr	Funk	2536	[Mg]MA_GospelFnk_C	4 / 4	4	106		•	Mega 60s Clean
Gtr	Funk	2537	[Mg]MB_GospelFnk_C	4 / 4	4	106		•	:
Gtr	Funk	2538	[Mg]MC_GospelFnk_C	4 / 4	4	106		•	:
Gtr	Funk	2539	[Mg]FA_GospelFnk_C	4 / 4	1	106		•	:
Gtr	Funk	2540	[Mg]FB_GospelFnk_C	4 / 4	1	106		•	:
Gtr	Funk	2541	[Mg]FC_GospelFnk_C	4 / 4	1	106		•	:
Gtr	Funk	2542	[Mg]BA_GospelFnk_C	4 / 4	1	106		•	:
Gtr	Funk	2543	[Mg]EA_GospelFnk_C	4 / 4	4	106		•	:
Gtr	Funk	2544	[Mg]EB_GospelFnk_C	4 / 4	3	106		•	:
Gtr	Funk	2545	[Mg]MA_Funk Dsc_C	4 / 4	2	126		•	Mega 60s Small Blues
Gtr	Funk	2546	[Mg]MB_Funk Dsc_C	4 / 4	2	126		•	:
Gtr	Funk	2547	[Mg]MC_Funk Dsc_C	4 / 4	2	126		•	:
Gtr	Funk	2548	[Mg]FA_Funk Dsc_C	4 / 4	1	126		•	:
Gtr	Funk	2549	[Mg]FB_Funk Dsc_C	4 / 4	1	126		•	:
Gtr	Funk	2550	[Mg]FC_Funk Dsc_C	4 / 4	1	126		•	:
Gtr	Funk	2551	[Mg]BA_Funk Dsc_C	4 / 4	1	126		•	:
Gtr	Funk	2552	[Mg]EA_Funk Dsc_C	4 / 4	4	126		•	:
Gtr	Funk	2553	[Mg]EB_Funk Dsc_C	4 / 4	3	126		•	:
Gtr	Funk	2554	[Mg]MA_70DscFunk_C	4 / 4	4	112		•	Mega 1coil Slap Dist
Gtr	Funk	2555	[Mg]MB_70DscFunk_C	4 / 4	4	112		•	:
Gtr	Funk	2556	[Mg]MC_70DscFunk_C	4 / 4	4	112		•	:
Gtr	Funk	2557	[Mg]FA_70DscFunk_C	4 / 4	1	112		•	:
Gtr	Funk	2558	[Mg]FB_70DscFunk_C	4 / 4	1	112		•	:
Gtr	Funk	2559	[Mg]FC_70DscFunk_C	4 / 4	1	112		•	:
Gtr	Funk	2560	[Mg]BA_70DscFunk_C	4 / 4	1	112		•	:
Gtr	Funk	2561	[Mg]EA_70DscFunk_C	4 / 4	4	112		•	:
Gtr	Funk	2562	[Mg]EB_70DscFunk_C	4 / 4	3	112		•	:
Gtr	House	2563	[Mg]MA_Dsc House_C	4 / 4	4	126		•	Mega 60s ChorusCombo
Gtr	House	2564	[Mg]MB_Dsc House_C	4 / 4	4	126		•	:
Gtr	House	2565	[Mg]MC_Dsc House_C	4 / 4	4	126		•	:
Gtr	House	2566	[Mg]FA_Dsc House_C	4 / 4	1	126		•	:
Gtr	House	2567	[Mg]FB_Dsc House_C	4 / 4	1	126		•	:
Gtr	House	2568	[Mg]FC_Dsc House_C	4 / 4	1	126		•	:
Gtr	House	2569	[Mg]BA_Dsc House_C	4 / 4	1	126		•	:
Gtr	Jazz	2570	[Mg]MA_JzGtrClub_C	4 / 4	8	142		•	Mega Jazz Guitar
Gtr	Jazz	2571	[Mg]MB_JzGtrClub_C	4 / 4	8	142		•	:
Gtr	Jazz	2572	[Mg]MC_JzGtrClub_C	4 / 4	8	142		•	:
Gtr	Jazz	2573	[Mg]FA_JzGtrClub_C	4 / 4	1	142		•	:
Gtr	Jazz	2574	[Mg]FB_JzGtrClub_C	4 / 4	1	142		•	:
Gtr	Jazz	2575	[Mg]FC_JzGtrClub_C	4 / 4	1	142		•	:
Gtr	Jazz	2576	[Mg]BA_JzGtrClub_C	4 / 4	1	142		•	:
Gtr	Jazz	2577	[Mg]EA_JzGtrClub_C	4 / 4	6	142		•	:
Gtr	Jazz	2578	[Mg]MA_JazWizMed_C	3 / 4	8	180		•	:
Gtr	Jazz	2579	[Mg]MB_JazWizMed_C	3 / 4	8	180		•	:
Gtr	Jazz	2580	[Mg]MC_JazWizMed_C	3 / 4	8	180		•	:
Gtr	Jazz	2581	[Mg]FA_JazWizMed_C	3 / 4	1	180		•	:
Gtr	Jazz	2582	[Mg]FB_JazWizMed_C	3 / 4	1	180		•	:
Gtr	Jazz	2583	[Mg]FC_JazWizMed_C	3 / 4	1	180		•	:
Gtr	Jazz	2584	[Mg]BA_JazWizMed_C	3 / 4	1	180		•	:
Gtr	Jazz	2585	[Mg]EA_JazWizMed_C	3 / 4	7	180		•	:
Gtr	Jazz	2586	[Mg]MA_ShifBlues_C	4 / 4	4	115		•	Mega 60s Tube Tone
Gtr	Jazz	2587	[Mg]MB_ShifBlues_C	4 / 4	4	115		•	:
Gtr	Jazz	2588	[Mg]MC_ShifBlues_C	4 / 4	4	115		•	:
Gtr	Jazz	2589	[Mg]FA_ShifBlues_C	4 / 4	1	115	</		

Main Category	Sub Category	ARP No.	ARP Name	Time Signature	Length	Original Tempo	Accent	Random SFX	Sound Type
Gtr	Jazz	2610	[Mg]BA_PnoBoogie_C	4/4	1	160		●	:
Gtr	Jazz	2611	[Mg]EA_PnoBoogie_C	4/4	5	160		●	:
Gtr	Jazz	2612	[Mg]EB_PnoBoogie_C	4/4	5	160		●	:
Gtr	Latin	2613	[Mg]MA_BrzSamba_C	4/4	4	96		●	Mega Nylon
Gtr	Latin	2614	[Mg]MB_BrzSamba_C	4/4	4	96		●	:
Gtr	Latin	2615	[Mg]MC_BrzSamba_C	4/4	4	96		●	:
Gtr	Latin	2616	[Mg]FA_BrzSamba_C	4/4	1	96		●	:
Gtr	Latin	2617	[Mg]FB_BrzSamba_C	4/4	1	96		●	:
Gtr	Latin	2618	[Mg]FC_BrzSamba_C	4/4	1	96		●	:
Gtr	Latin	2619	[Mg]BA_BrzSamba_C	4/4	1	96		●	:
Gtr	Latin	2620	[Mg]EA_BrzSamba_C	4/4	4	96		●	:
Gtr	Latin	2621	[Mg]EB_BrzSamba_C	4/4	4	96		●	:
Gtr	Latin	2622	[Mg]MA_Bossa_C	4/4	4	124		●	:
Gtr	Latin	2623	[Mg]MB_Bossa_C	4/4	4	124		●	:
Gtr	Latin	2624	[Mg]MC_Bossa_C	4/4	4	124		●	:
Gtr	Latin	2625	[Mg]FA_Bossa_C	4/4	1	124		●	:
Gtr	Latin	2626	[Mg]FB_Bossa_C	4/4	1	124		●	:
Gtr	Latin	2627	[Mg]FC_Bossa_C	4/4	1	124		●	:
Gtr	Latin	2628	[Mg]BA_Bossa_C	4/4	1	124		●	:
Gtr	Latin	2629	[Mg]EA_Bossa_C	4/4	4	123		●	:
Gtr	Latin	2630	[Mg]EB_Bossa_C	4/4	4	123		●	:
Gtr	Latin	2631	[Mg]MA_Bossa	4/4	4	123		●	:
Gtr	Latin	2632	[Mg]MB_Bossa	4/4	4	123		●	:
Gtr	Latin	2633	[Mg]MC_Bossa	4/4	4	123		●	:
Gtr	Latin	2634	[Mg]FA_Bossa	4/4	1	123		●	:
Gtr	Latin	2635	[Mg]FB_Bossa	4/4	1	123		●	:
Gtr	Latin	2636	[Mg]FC_Bossa	4/4	1	123		●	:
Gtr	Latin	2637	[Mg]BA_Bossa	4/4	1	123		●	:
Gtr	Latin	2638	[Mg]MA_Merengue_C	4/4	4	130		●	Mega Steel
Gtr	Latin	2639	[Mg]MB_Merengue_C	4/4	4	130		●	:
Gtr	Latin	2640	[Mg]MC_Merengue_C	4/4	4	130		●	:
Gtr	Latin	2641	[Mg]FA_Merengue_C	4/4	1	130		●	:
Gtr	Latin	2642	[Mg]FB_Merengue_C	4/4	1	130		●	:
Gtr	Latin	2643	[Mg]FC_Merengue_C	4/4	1	130		●	:
Gtr	Latin	2644	[Mg]BA_Merengue_C	4/4	1	130		●	:
Gtr	Latin	2645	[Mg]EA_Merengue_C	4/4	3	130		●	:
Gtr	Latin	2646	[Mg]EB_Merengue_C	4/4	3	130		●	:
Gtr	Latin	2647	[Mg]MA_Merengue	4/4	4	130		●	:
Gtr	Latin	2648	[Mg]MB_Merengue	4/4	4	130		●	:
Gtr	Latin	2649	[Mg]MC_Merengue	4/4	4	130		●	:
Gtr	Latin	2650	[Mg]FA_Merengue	4/4	1	130		●	:
Gtr	Latin	2651	[Mg]FB_Merengue	4/4	1	130		●	:
Gtr	Latin	2652	[Mg]FC_Merengue	4/4	1	130		●	:
Gtr	Latin	2653	[Mg]BA_Merengue	4/4	1	130		●	:
Gtr	World	2654	[Mg]MA1_ReggaeSh_C	4/4	4	90		●	Mega 60s Clean
Gtr	World	2655	[Mg]MB1_ReggaeSh_C	4/4	4	90		●	:
Gtr	World	2656	[Mg]MC1_ReggaeSh_C	4/4	4	90		●	:
Gtr	World	2657	[Mg]FA1_ReggaeSh_C	4/4	1	90		●	:
Gtr	World	2658	[Mg]FB1_ReggaeSh_C	4/4	1	90		●	:
Gtr	World	2659	[Mg]FC1_ReggaeSh_C	4/4	1	90		●	:
Gtr	World	2660	[Mg]BA1_ReggaeSh_C	4/4	1	90		●	:
Gtr	World	2661	[Mg]EA1_ReggaeSh_C	4/4	3	90		●	:
Gtr	World	2662	[Mg]EB1_ReggaeSh_C	4/4	4	90		●	:
Gtr	World	2663	[Mg]MA2_ReggaeSh_C	4/4	4	90		●	Mega 1coil SlapClean
Gtr	World	2664	[Mg]MB2_ReggaeSh_C	4/4	4	90		●	:
Gtr	World	2665	[Mg]MC2_ReggaeSh_C	4/4	4	90		●	:
Gtr	World	2666	[Mg]FA2_ReggaeSh_C	4/4	1	90		●	:
Gtr	World	2667	[Mg]FB2_ReggaeSh_C	4/4	1	90		●	:
Gtr	World	2668	[Mg]FC2_ReggaeSh_C	4/4	1	90		●	:
Gtr	World	2669	[Mg]BA2_ReggaeSh_C	4/4	1	90		●	:
Gtr	World	2670	[Mg]EA2_ReggaeSh_C	4/4	3	90		●	:
Gtr	World	2671	[Mg]EB2_ReggaeSh_C	4/4	4	90		●	:
Gtr	World	2672	[Mg]MA_JmbReggae_C	4/4	4	100		●	Mega 60s Clean
Gtr	World	2673	[Mg]MB_JmbReggae_C	4/4	4	100		●	:
Gtr	World	2674	[Mg]MC_JmbReggae_C	4/4	4	100		●	:
Gtr	World	2675	[Mg]FA_JmbReggae_C	4/4	1	100		●	:
Gtr	World	2676	[Mg]FB_JmbReggae_C	4/4	1	100		●	:
Gtr	World	2677	[Mg]FC_JmbReggae_C	4/4	1	100		●	:
Gtr	World	2678	[Mg]BA_JmbReggae_C	4/4	1	100		●	:
Gtr	World	2679	[Mg]EA_JmbReggae_C	4/4	3	100		●	:
Gtr	World	2680	[Mg]EB_JmbReggae_C	4/4	3	100		●	:
Gtr	World	2681	[Mg]MA_RmbFlamm_C	4/4	4	106		●	Mega Nylon
Gtr	World	2682	[Mg]MB_RmbFlamm_C	4/4	4	106		●	:
Gtr	World	2683	[Mg]MC_RmbFlamm_C	4/4	4	106		●	:
Gtr	World	2684	[Mg]FA_RmbFlamm_C	4/4	1	106		●	:
Gtr	World	2685	[Mg]FB_RmbFlamm_C	4/4	1	106		●	:
Gtr	World	2686	[Mg]FC_RmbFlamm_C	4/4	1	106		●	:
Gtr	World	2687	[Mg]BA_RmbFlamm_C	4/4	1	106		●	:
Gtr	World	2688	[Mg]EA_RmbFlamm_C	4/4	3	106		●	:
Gtr	World	2689	[Mg]EB_RmbFlamm_C	4/4	3	106		●	:
Gtr	World	2690	[Mg]MA_ModBlugs_C	4/4	4	121		●	Mega 1coil Old R&R
Gtr	World	2691	[Mg]MB_ModBlugs_C	4/4	4	121		●	:
Gtr	World	2692	[Mg]MC_ModBlugs_C	4/4	4	121		●	:
Gtr	World	2693	[Mg]FA_ModBlugs_C	4/4	1	121		●	:
Gtr	World	2694	[Mg]FB_ModBlugs_C	4/4	1	121		●	:
Gtr	World	2695	[Mg]FC_ModBlugs_C	4/4	1	121		●	:
Gtr	World	2696	[Mg]BA_ModBlugs_C	4/4	1	121		●	:

Main Category	Sub Category	ARP No.	ARP Name	Time Signature	Length	Original Tempo	Accent	Random SFX	Sound Type
Gtr	World	2697	[Mg]EA_ModBlugs_C	4/4	6	121		●	:
Gtr	World	2698	[Mg]MA_IrishHymn_C	3/4	4	70		●	Mega Steel
Gtr	World	2699	[Mg]MB_IrishHymn_C	3/4	4	70		●	:
Gtr	World	2700	[Mg]MC_IrishHymn_C	3/4	4	70		●	:
Gtr	World	2701	[Mg]FA_IrishHymn_C	3/4	1	70		●	:
Gtr	World	2702	[Mg]FB_IrishHymn_C	3/4	1	70		●	:
Gtr	World	2703	[Mg]FC_IrishHymn_C	3/4	1	70		●	:
Gtr	World	2704	[Mg]BA_IrishHymn_C	3/4	1	70		●	:
Gtr	World	2705	[Mg]EA_IrishHymn_C	3/4	5	70		●	:
Gtr	World	2706	[Mg]EB_IrishHymn_C	3/4	5	70		●	:
Gtr	World	2707	[Mg]MA_TurkshEu1_C	4/4	4	112		●	:
Gtr	World	2708	[Mg]MB_TurkshEu1_C	4/4	4	112		●	:
Gtr	World	2709	[Mg]MC_TurkshEu1_C	4/4	4	112		●	:
Gtr	World	2710	[Mg]FA_TurkshEu1_C	4/4	1	112		●	:
Gtr	World	2711	[Mg]FB_TurkshEu1_C	4/4	1	112		●	:
Gtr	World	2712	[Mg]FC_TurkshEu1_C	4/4	1	112		●	:
Gtr	World	2713	[Mg]BA_TurkshEu1_C	4/4	1	112		●	:
Gtr	World	2714	[Mg]EA_TurkshEu1_C	4/4	3	112		●	:
Bass	Rock	2715	MA_Under Dirt_N	4/4	1	95			Finger Bass
Bass	Rock	2716	MA_AlternaRock1_N	4/4	4	97			:
Bass	Rock	2717	MB_AlternaRock1_N	4/4	4	97			:
Bass	Rock	2718	MC_AlternaRock1	4/4	4	97			:
Bass	Rock	2719	FA_AlternaRock1	4/4	1	97			:
Bass	Rock	2720	FB_AlternaRock1	4/4	1	97			:
Bass	Rock	2721	FC_AlternaRock1_N	4/4	1	97			:
Bass	Rock	2722	BA_AlternaRock1	4/4	1	97			:
Bass	Rock	2723	MA_AlternaRock2_N	4/4	4	100			:
Bass	Rock	2724	MB_AlternaRock2_N	4/4	4	100			:
Bass	Rock	2725	MC_AlternaRock2_N	4/4	4	100			:
Bass	Rock	2726	FA_AlternaRock2_N	4/4	1	100			:
Bass	Rock	2727	FB_AlternaRock2_N	4/4	1	100			:
Bass	Rock	2728	FC_AlternaRock2_N	4/4	1	100			:
Bass	Rock	2729	BA_AlternaRock2	4/4	1	100			:
Bass	Rock	2730	MA_Xover Rock	4/4	1	100			:
Bass	Rock	2731	MB_Xover Rock	4/4	1	100			:
Bass	Rock	2732	MC_Xover Rock_N	4/4	2	100			:
Bass	Rock	2733	MD_Xover Rock_N	4/4	2	100			:
Bass	Rock	2734	IA_Xover Rock_N	4/4	2	100			:
Bass	Rock	2735	FB_Xover Rock_N	4/4	1	100			:
Bass	Rock	2736	FC_Xover Rock_N	4/4	2	100			:
Bass	Rock	2737	MA_8Beat Rock_C	4/4	4	75			:
Bass	Rock	2738	MB_8Beat Rock_C	4/4	4	75			:
Bass	Rock	2739	MC_8Beat Rock_C	4/4	4	75			:
Bass	Rock	2740	FA_8Beat Rock_C	4/4	1	75			:
Bass	Rock	2741	FB_8Beat Rock_C	4/4	1	75			:
Bass	Rock	2742	FC_8Beat Rock_C	4/4	1	75			:
Bass	Rock	2743	BA_8Beat Rock_C	4/4	1	75			:
Bass	Rock	2744	MA_8Beat Rock_N	4/4	4	75			:
Bass	Rock	2745	MB_8Beat Rock_N	4/4	4	75			:
Bass	Rock	2746	MC_8Beat Rock_N	4/4	4	75			:
Bass	Rock	2747	FA_8Beat Rock_N	4/4	1	75			:
Bass	Rock	2748	FB_8Beat Rock_N	4/4	1	75			:
Bass	Rock	2749	FC_8Beat Rock_N	4/4	1	75			:
Bass	Rock	2750	BA_8Beat Rock	4/4	1	75			:
Bass	Rock	2751	MA_ProgresRock1_C	4/4	4	110			Synth Bass
Bass	Rock	2752	MB_ProgresRock1_C	4/4	3	110			:
Bass	Rock	2753	MC_ProgresRock1_C	4/4	4	110			:
Bass	Rock	2754	FA_ProgresRock1_C	4/4	1	110			:
Bass	Rock	2755	FB_ProgresRock1_C	4/4	1	110			:
Bass	Rock	2756	FC_ProgresRock1_C	4/4	1	110			:
Bass	Rock	2757	BA_ProgresRock1_C	4/4	1	110			:
Bass	Rock	2758	MA_ProgresRock1_N	4/4	4	110			:
Bass	Rock	2759	MB_ProgresRock1_N	4/4	3	110			:
Bass	Rock	2760	MC_ProgresRock1	4/4	4	110			:
Bass	Rock	2761	FA_ProgresRock1_N	4/4	1	110			:
Bass	Rock	2762	FB_ProgresRock1	4/4	1	110			:
Bass	Rock	2763	FC_ProgresRock1	4/4	1	110			:
Bass	Rock	2764	BA_ProgresRock1	4/4	1	110			:
Bass	Rock	2765	MA_ProgresRock2_C	4/4	4	120			Finger Bass
Bass	Rock	2766	MB_ProgresRock2_C	4/4	4	120			:
Bass	Rock	2767	MC_ProgresRock2_C	4/4	4	120			:
Bass	Rock	2768	FA_ProgresRock2_C	4/4	1	120			:
Bass	Rock	2769	FB_ProgresRock2_C	4/4	1	120			:
Bass	Rock	2770	FC_ProgresRock2_C	4/4	1	120			:
Bass	Rock	2771	BA_ProgresRock2_C	4/4	1	120			:
Bass	Rock	2772	MA_ProgresRock2	4/4	4	120			:
Bass	Rock	2773	MB_ProgresRock2						

Arpeggio Type List

Main Category	Sub Category	ARP No.	ARP Name	Time Signature	Length	Original Tempo	Accent	Random SFX	Sound Type
Bass	Pop Rock	2784	MA_SyBassRiff Pop 1	4/4	4	100			Synth Bass
Bass	Pop Rock	2785	MA_SyBassRiff Pop 2	4/4	4	100			:
Bass	Pop Rock	2786	MA_SyBassRiff Pop 3	4/4	4	105			:
Bass	Pop Rock	2787	MA_SyBassRiff Pop 4	4/4	4	120			:
Bass	Pop Rock	2788	MA_SyBassRiff Shf1	4/4	2	120			:
Bass	Pop Rock	2789	MA_SyBassRiff Shf 2	4/4	2	120			:
Bass	Pop Rock	2790	MA_SyBassRiff Shf 3	4/4	4	120			:
Bass	Pop Rock	2791	MA_SyBassRiff Shf 4	4/4	4	120			:
Bass	Pop Rock	2792	MA_Active Bass_N	4/4	4	120			Finger Bass
Bass	Pop Rock	2793	MA_NakedFretbrd_N	4/4	4	105			Fretless Bass
Bass	Pop Rock	2794	MA_Ice Cream_N	4/4	1	98			Synth Bass
Bass	Pop Rock	2795	MA_Guitar Pop 2_N	4/4	2	90			Finger Bass
Bass	Pop Rock	2796	MB_Guitar Pop 2_N	4/4	1	90			:
Bass	Pop Rock	2797	MC_Guitar Pop 2_N	4/4	2	90			:
Bass	Pop Rock	2798	MD_Guitar Pop 2_N	4/4	2	90			:
Bass	Pop Rock	2799	FB_Guitar Pop 2_N	4/4	1	90			:
Bass	Pop Rock	2800	FC_Guitar Pop 2_N	4/4	2	90			:
Bass	Pop Rock	2801	MA_FingerPickin_N	4/4	1	120			:
Bass	Pop Rock	2802	MB_FingerPickin_N	4/4	2	120			:
Bass	Pop Rock	2803	MC_FingerPickin_N	4/4	1	120			:
Bass	Pop Rock	2804	MD_FingerPickin_N	4/4	1	120			:
Bass	Pop Rock	2805	FA_FingerPickin_N	4/4	1	120			:
Bass	Pop Rock	2806	FB_FingerPickin_N	4/4	1	120			:
Bass	Pop Rock	2807	FC_FingerPickin_N	4/4	1	120			:
Bass	Pop Rock	2808	MB_Folk Rock	4/4	1	120			:
Bass	Pop Rock	2809	MC_Folk Rock	4/4	1	120			:
Bass	Pop Rock	2810	MD_Folk Rock	4/4	1	120			:
Bass	Pop Rock	2811	FA_Folk Rock_N	4/4	1	120			:
Bass	Pop Rock	2812	FC_Folk Rock_N	4/4	1	120			:
Bass	Pop Rock	2813	MB_70s Rock_N	4/4	4	130			:
Bass	Pop Rock	2814	MC_70s Rock_N	4/4	2	130			:
Bass	Pop Rock	2815	MD_70s Rock	4/4	4	130			:
Bass	Pop Rock	2816	FA_70s Rock_N	4/4	1	130			:
Bass	Pop Rock	2817	MA_8Beat Basic_C	4/4	4	120			:
Bass	Pop Rock	2818	MB_8Beat Basic_C	4/4	4	120			:
Bass	Pop Rock	2819	MC_8Beat Basic_C	4/4	4	120			:
Bass	Pop Rock	2820	FA_8Beat Basic_C	4/4	1	120			:
Bass	Pop Rock	2821	FB_8Beat Basic_C	4/4	1	120			:
Bass	Pop Rock	2822	FC_8Beat Basic_C	4/4	1	120			:
Bass	Pop Rock	2823	BA_8Beat Basic_C	4/4	1	120			:
Bass	Pop Rock	2824	MA_8Beat Basic_N	4/4	4	120			:
Bass	Pop Rock	2825	MB_8Beat Basic_N	4/4	4	120			:
Bass	Pop Rock	2826	MC_8Beat Basic_N	4/4	4	120			:
Bass	Pop Rock	2827	FA_8Beat Basic_N	4/4	1	120			:
Bass	Pop Rock	2828	FB_8Beat Basic	4/4	1	120			:
Bass	Pop Rock	2829	FC_8Beat Basic	4/4	1	120			:
Bass	Pop Rock	2830	BA_8Beat Basic	4/4	1	120			:
Bass	Pop Rock	2831	MA_8Beat Soft_C	4/4	4	100			:
Bass	Pop Rock	2832	MB_8Beat Soft_C	4/4	4	100			:
Bass	Pop Rock	2833	MC_8Beat Soft_C	4/4	4	100			:
Bass	Pop Rock	2834	FA_8Beat Soft_C	4/4	1	100			:
Bass	Pop Rock	2835	FB_8Beat Soft_C	4/4	1	100			:
Bass	Pop Rock	2836	FC_8Beat Soft_C	4/4	1	100			:
Bass	Pop Rock	2837	BA_8Beat Soft_C	4/4	1	100			:
Bass	Pop Rock	2838	MA_8Beat Soft_N	4/4	4	100			:
Bass	Pop Rock	2839	MB_8Beat Soft_N	4/4	4	100			:
Bass	Pop Rock	2840	MC_8Beat Soft_N	4/4	4	100			:
Bass	Pop Rock	2841	FA_8Beat Soft	4/4	1	100			:
Bass	Pop Rock	2842	FB_8Beat Soft_N	4/4	1	100			:
Bass	Pop Rock	2843	FC_8Beat Soft_N	4/4	1	100			:
Bass	Pop Rock	2844	BA_8Beat Soft	4/4	1	100			:
Bass	Pop Rock	2845	MA_Soft Rock_N	4/4	1	120			:
Bass	Pop Rock	2846	MB_Soft Rock_N	4/4	1	120			:
Bass	Pop Rock	2847	MC_Soft Rock	4/4	1	120			:
Bass	Pop Rock	2848	MD_Soft Rock	4/4	1	120			:
Bass	Pop Rock	2849	IA_Soft Rock_N	4/4	1	120			:
Bass	Pop Rock	2850	FA_Soft Rock_N	4/4	1	120			:
Bass	Pop Rock	2851	FB_Soft Rock	4/4	1	120			:
Bass	Pop Rock	2852	MA_16BeatBasic1_C	4/4	4	90			Finger/Slap Bass
Bass	Pop Rock	2853	MB_16BeatBasic1_C	4/4	4	90			:
Bass	Pop Rock	2854	MC_16BeatBasic1_C	4/4	4	90			:
Bass	Pop Rock	2855	FA_16BeatBasic1_C	4/4	1	90			:
Bass	Pop Rock	2856	FB_16BeatBasic1_C	4/4	1	90			:
Bass	Pop Rock	2857	FC_16BeatBasic1_C	4/4	1	90			:
Bass	Pop Rock	2858	BA_16BeatBasic1_C	4/4	1	90			:
Bass	Pop Rock	2859	MA_16BeatBasic1_N	4/4	4	90			:
Bass	Pop Rock	2860	MB_16BeatBasic1_N	4/4	4	90			:
Bass	Pop Rock	2861	MC_16BeatBasic1_N	4/4	4	90			:
Bass	Pop Rock	2862	FA_16BeatBasic1_N	4/4	1	90			:
Bass	Pop Rock	2863	FB_16BeatBasic1_N	4/4	1	90			:
Bass	Pop Rock	2864	FC_16BeatBasic1_N	4/4	1	90			:
Bass	Pop Rock	2865	BA_16BeatBasic1	4/4	1	90			:
Bass	Pop Rock	2866	MA_16BeatBasic2_C	4/4	4	77			Synth Bass
Bass	Pop Rock	2867	MB_16BeatBasic2_C	4/4	4	77			:
Bass	Pop Rock	2868	MC_16BeatBasic2_C	4/4	4	77			:
Bass	Pop Rock	2869	FA_16BeatBasic2_C	4/4	1	77			:
Bass	Pop Rock	2870	FB_16BeatBasic2_C	4/4	1	77			:

Main Category	Sub Category	ARP No.	ARP Name	Time Signature	Length	Original Tempo	Accent	Random SFX	Sound Type
Bass	Pop Rock	2871	FC_16BeatBasic2_C	4/4	1	77			:
Bass	Pop Rock	2872	BA_16BeatBasic2_C	4/4	1	77			:
Bass	Pop Rock	2873	MA_16BeatBasic2_N	4/4	3	77			:
Bass	Pop Rock	2874	MB_16BeatBasic2_N	4/4	4	77			:
Bass	Pop Rock	2875	MC_16BeatBasic2_N	4/4	4	77			:
Bass	Pop Rock	2876	FA_16BeatBasic2_N	4/4	1	77			:
Bass	Pop Rock	2877	FB_16BeatBasic2_N	4/4	1	77			:
Bass	Pop Rock	2878	FC_16BeatBasic2_N	4/4	1	77			:
Bass	Pop Rock	2879	BA_16BeatBasic2	4/4	1	77			:
Bass	Pop Rock	2880	MA_16Beat Pop 2_C	4/4	4	94			:
Bass	Pop Rock	2881	MB_16Beat Pop 2_C	4/4	4	94			:
Bass	Pop Rock	2882	MC_16Beat Pop 2_C	4/4	4	94			:
Bass	Pop Rock	2883	FA_16Beat Pop 2_C	4/4	1	94			:
Bass	Pop Rock	2884	FB_16Beat Pop 2_C	4/4	1	94			:
Bass	Pop Rock	2885	FC_16Beat Pop 2_C	4/4	1	94			:
Bass	Pop Rock	2886	BA_16Beat Pop 2_C	4/4	1	94			:
Bass	Pop Rock	2887	MA_16Beat Pop 2	4/4	4	94			:
Bass	Pop Rock	2888	MB_16Beat Pop 2	4/4	4	94			:
Bass	Pop Rock	2889	MC_16Beat Pop 2	4/4	4	94			:
Bass	Pop Rock	2890	FA_16Beat Pop 2	4/4	1	94			:
Bass	Pop Rock	2891	FB_16Beat Pop 2	4/4	1	94			:
Bass	Pop Rock	2892	FC_16Beat Pop 2	4/4	1	94			:
Bass	Pop Rock	2893	BA_16Beat Pop 2	4/4	1	94			:
Bass	Pop Rock	2894	MA_16Beat Rock_C	4/4	4	86			:
Bass	Pop Rock	2895	MB_16Beat Rock_C	4/4	4	86			:
Bass	Pop Rock	2896	MC_16Beat Rock_C	4/4	4	86			:
Bass	Pop Rock	2897	FA_16Beat Rock_C	4/4	1	86			:
Bass	Pop Rock	2898	FB_16Beat Rock_C	4/4	1	86			:
Bass	Pop Rock	2899	FC_16Beat Rock_C	4/4	1	86			:
Bass	Pop Rock	2900	BA_16Beat Rock_C	4/4	1	86			:
Bass	Pop Rock	2901	MA_16Beat Rock	4/4	4	86			:
Bass	Pop Rock	2902	MB_16Beat Rock	4/4	4	86			:
Bass	Pop Rock	2903	MC_16Beat Rock	4/4	4	86			:
Bass	Pop Rock	2904	FA_16Beat Rock	4/4	1	86			:
Bass	Pop Rock	2905	FB_16Beat Rock	4/4	1	86			:
Bass	Pop Rock	2906	FC_16Beat Rock	4/4	1	86			:
Bass	Pop Rock	2907	BA_16Beat Rock	4/4	1	86			:
Bass	Pop Rock	2908	MA_Piano Club_N	4/4	2	96			Finger Bass
Bass	Pop Rock	2909	MB_Piano Club_N	4/4	2	96			:
Bass	Pop Rock	2910	MC_Piano Club_N	4/4	2	96			:
Bass	Pop Rock	2911	MD_Piano Club_N	4/4	1	96			:
Bass	Pop Rock	2912	IA_Piano Club_N	4/4	2	96			:
Bass	Pop Rock	2913	FA_Piano Club_N	4/4	1	96			:
Bass	Pop Rock	2914	FB_Piano Club_N	4/4	1	96			:
Bass	Pop Rock	2915	FC_Piano Club_N	4/4	4	96			:
Bass	Pop Rock	2916	MA_Analog Pop	4/4	2	93			Pick Bass
Bass	Pop Rock	2917	MB_Analog Pop_N	4/4	2	93			:
Bass	Pop Rock	2918	MC_Analog Pop_N	4/4	2	93			:
Bass	Pop Rock	2919	MD_Analog Pop_N	4/4	4	93			:
Bass	Pop Rock	2920	IA_Analog Pop_N	4/4	2	93			:
Bass	Pop Rock	2921	FA_Analog Pop_N	4/4	1	93			:
Bass	Pop Rock	2922	FB_Analog Pop_N	4/4	1	93			:
Bass	Pop Rock	2923	FC_Analog Pop	4/4	2	93			:
Bass	Pop Rock	2924	MA_6/8 Pop_C	4/4	4	100			Finger/Slap Bass
Bass	Pop Rock	2925	MB_6/8 Pop_C	4/4	4	100			:
Bass	Pop Rock	2926	MC_6/8 Pop_C	4/4	4	100			:
Bass	Pop Rock	2927	FA_6/8 Pop_C	4/4	1	100			:
Bass	Pop Rock	2928	FB_6/8 Pop_C	4/4	1	100			:
Bass	Pop Rock	2929	FC_6/8 Pop_C	4/4	1	100			:
Bass	Pop Rock	2930	BA_6/8 Pop_C	4/4	1	100			:
Bass	Pop Rock	2931	EA_6/8 Pop_C	4/4	3	123			:
Bass	Pop Rock	2932	MA_6/8 Pop_N	4/4	4	100			:
Bass	Pop Rock	2933	MB_6/8 Pop_N	4/4	4	100			:
Bass	Pop Rock	2934	MC_6/8 Pop_N	4/4	4	100			:
Bass	Pop Rock	2935	FA_6/8 Pop_N	4/4	1	100			:
Bass	Pop Rock	2936	FB_6/8 Pop_N	4/4	1	100			:
Bass	Pop Rock	2937	FC_6/8 Pop_N	4/4	1	100			:
Bass	Pop Rock	2938	BA_6/8 Pop	4/4	1	100			:
Bass	Ballad	2939	MA_Unplugged3_C	4/4	4	113			Acoustic Bass
Bass	Ballad	2940	MB_Unplugged3_C	4/4	4	113			:
Bass	Ballad	2941	MC_Unplugged3_C	4/4	4	113			:
Bass	Ballad	2942	FA_Unplugged3_C	4/4	1	113			:
Bass	Ballad	2943	FB_Unplugged3_C	4/4	1	113			:
Bass	Ballad	2944	FC_Unplugged3_C	4/4	1	113			:
Bass	Ballad	2945	BA_Unplugged3_C	4/4	1	113			:
Bass	Ballad	2946	MA_Unplugged3_N	4/4	4	113			:
Bass	Ballad	2947	MB_Unplugged3_N	4/4	4	113			:
Bass	Ballad	2948	MC_Unplugged3_N	4/4	4	113			:
Bass	Ballad	2949	FA_Unplugged3	4/4	1	113			:
Bass	Ballad	2950	FB_Unplugged3_N	4/4	1</				

Main Category	Sub Category	ARP No.	ARP Name	Time Signature	Length	Original Tempo	Accent	Random SFX	Sound Type
Bass	Ballad	2958	FC_8Beat Slow_C	4/4	1	78			:
Bass	Ballad	2959	BA_8Beat Slow_C	4/4	1	78			:
Bass	Ballad	2960	MA_8Beat Slow	4/4	4	78			:
Bass	Ballad	2961	MB_8Beat Slow_N	4/4	4	78			:
Bass	Ballad	2962	MC_8Beat Slow_N	4/4	4	78			:
Bass	Ballad	2963	FA_8Beat Slow	4/4	1	78			:
Bass	Ballad	2964	FB_8Beat Slow_N	4/4	1	78			:
Bass	Ballad	2965	FC_8Beat Slow	4/4	1	78			:
Bass	Ballad	2966	BA_8Beat Slow	4/4	1	78			:
Bass	Ballad	2967	MA_Slowfeel	4/4	1	74			Fretless Bass
Bass	Ballad	2968	MB_Slowfeel_N	4/4	1	74			:
Bass	Ballad	2969	MC_Slowfeel_N	4/4	1	74			:
Bass	Ballad	2970	MD_Slowfeel_N	4/4	1	74			:
Bass	Ballad	2971	IA_Slowfeel_N	4/4	2	74			:
Bass	Ballad	2972	FA_Slowfeel_N	4/4	1	74			:
Bass	Ballad	2973	FB_Slowfeel_N	4/4	1	74			:
Bass	Ballad	2974	FC_Slowfeel_N	4/4	2	74			:
Bass	Ballad	2975	MA_16Bt Ballad2_C	4/4	4	75			Finger Bass
Bass	Ballad	2976	MB_16Bt Ballad2_C	4/4	4	75			:
Bass	Ballad	2977	MC_16Bt Ballad2_C	4/4	4	75			:
Bass	Ballad	2978	FA_16Bt Ballad2_C	4/4	1	75			:
Bass	Ballad	2979	FB_16Bt Ballad2_C	4/4	1	75			:
Bass	Ballad	2980	FC_16Bt Ballad2_C	4/4	1	75			:
Bass	Ballad	2981	BA_16Bt Ballad2_C	4/4	1	75			:
Bass	Ballad	2982	MA_16Bt Ballad2_N	4/4	4	75			:
Bass	Ballad	2983	MB_16Bt Ballad2_N	4/4	4	75			:
Bass	Ballad	2984	MC_16Bt Ballad2_N	4/4	4	75			:
Bass	Ballad	2985	FA_16Bt Ballad2	4/4	1	75			:
Bass	Ballad	2986	FB_16Bt Ballad2	4/4	1	75			:
Bass	Ballad	2987	FC_16Bt Ballad2_N	4/4	1	75			:
Bass	Ballad	2988	BA_16Bt Ballad2	4/4	1	75			:
Bass	Ballad	2989	MA_6/8 Ballad_C	6/8	4	87			Finger/Slap Bass
Bass	Ballad	2990	MB_6/8 Ballad_C	6/8	4	87			:
Bass	Ballad	2991	MC_6/8 Ballad_C	6/8	4	87			:
Bass	Ballad	2992	FA_6/8 Ballad_C	6/8	1	87			:
Bass	Ballad	2993	FB_6/8 Ballad_C	6/8	1	87			:
Bass	Ballad	2994	FC_6/8 Ballad_C	6/8	1	87			:
Bass	Ballad	2995	BA_6/8 Ballad_C	6/8	1	87			:
Bass	Ballad	2996	EA_6/8 Ballad_C	6/8	6	87			:
Bass	Ballad	2997	EB_6/8 Ballad_C	6/8	6	87			:
Bass	Ballad	2998	MA_6/8 Ballad_N	6/8	4	87			:
Bass	Ballad	2999	MB_6/8 Ballad_N	6/8	4	87			:
Bass	Ballad	3000	MC_6/8 Ballad_N	6/8	4	87			:
Bass	Ballad	3001	FA_6/8 Ballad_N	6/8	1	87			:
Bass	Ballad	3002	FB_6/8 Ballad	6/8	1	87			:
Bass	Ballad	3003	FC_6/8 Ballad	6/8	1	87			:
Bass	Ballad	3004	BA_6/8 Ballad	6/8	1	87			:
Bass	Hip Hop	3005	MA_SyBsriff1-01	4/4	4	120			Synth Bass
Bass	Hip Hop	3006	MA_SyBsriff1-02	4/4	4	120			:
Bass	Hip Hop	3007	MA_SyBsriff1-03	4/4	4	120			:
Bass	Hip Hop	3008	MA_SyBsriff1-04	4/4	4	120			:
Bass	Hip Hop	3009	MA_SyBassriff HH 1	4/4	4	100			:
Bass	Hip Hop	3010	MA_SyBassriff HH 2	4/4	4	105			:
Bass	Hip Hop	3011	MA_SyBassriff HH 3	4/4	4	120			:
Bass	Hip Hop	3012	MA_SyBassriff HH 4	4/4	4	120			:
Bass	Hip Hop	3013	MA_SyBassriff FM 5	4/4	4	120			:
Bass	Hip Hop	3014	MA_SyBassriff FM 6	4/4	4	130			:
Bass	Hip Hop	3015	MA_SyBassriff FM 7	4/4	4	120			:
Bass	Hip Hop	3016	MA_SyBassriff FM 8	4/4	4	120			:
Bass	Hip Hop	3017	MA_TrapHardBass_N	4/4	2	107			:
Bass	Hip Hop	3018	MA_Yay Area Funk_N	4/4	2	95			:
Bass	Hip Hop	3019	MA_Grouchy Bass_N	4/4	4	105			:
Bass	Hip Hop	3020	MA_2BZ4U_C	4/4	4	75			:
Bass	Hip Hop	3021	MB_2BZ4U_C	4/4	4	75			:
Bass	Hip Hop	3022	MC_2BZ4U_C	4/4	4	75			:
Bass	Hip Hop	3023	MA_2BZ4U_N	4/4	4	75			:
Bass	Hip Hop	3024	MB_2BZ4U_N	4/4	4	75			:
Bass	Hip Hop	3025	MC_2BZ4U_N	4/4	4	75			:
Bass	Hip Hop	3026	MA_DirtySynth_C	4/4	4	85			:
Bass	Hip Hop	3027	MB_DirtySynth_C	4/4	4	85			:
Bass	Hip Hop	3028	MC_DirtySynth_C	4/4	4	85			:
Bass	Hip Hop	3029	MA_DirtySynth_N	4/4	4	85			:
Bass	Hip Hop	3030	MB_DirtySynth_N	4/4	4	85			:
Bass	Hip Hop	3031	MC_DirtySynth_N	4/4	4	85			:
Bass	Hip Hop	3032	MA_PepRally_C	4/4	2	75			:
Bass	Hip Hop	3033	MB_PepRally_C	4/4	2	75			:
Bass	Hip Hop	3034	MC_PepRally_C	4/4	2	75			:
Bass	Hip Hop	3035	MD_PepRally_C	4/4	2	75			:
Bass	Hip Hop	3036	ME_PepRally_C	4/4	2	75			:
Bass	Hip Hop	3037	MA_PepRally	4/4	2	75			:
Bass	Hip Hop	3038	MB_PepRally	4/4	2	75			:
Bass	Hip Hop	3039	MC_PepRally	4/4	2	75			:
Bass	Hip Hop	3040	MD_PepRally	4/4	2	75			:
Bass	Hip Hop	3041	ME_PepRally	4/4	2	75			:
Bass	Hip Hop	3042	MA_HipHopEpic_C	4/4	2	85			:
Bass	Hip Hop	3043	MB_HipHopEpic_C	4/4	2	85			:
Bass	Hip Hop	3044	MC_HipHopEpic_C	4/4	2	85			:

Main Category	Sub Category	ARP No.	ARP Name	Time Signature	Length	Original Tempo	Accent	Random SFX	Sound Type
Bass	Hip Hop	3045	MA_HipHopEpic	4/4	2	85			:
Bass	Hip Hop	3046	MB_HipHopEpic	4/4	2	85			:
Bass	Hip Hop	3047	MC_HipHopEpic	4/4	2	85			:
Bass	Hip Hop	3048	MA_New Hip Hop_C	4/4	2	85			:
Bass	Hip Hop	3049	MB_New Hip Hop_C	4/4	2	85			:
Bass	Hip Hop	3050	MC_New Hip Hop_C	4/4	2	85			:
Bass	Hip Hop	3051	FA_New Hip Hop_C	4/4	1	85			:
Bass	Hip Hop	3052	FB_New Hip Hop_C	4/4	1	85			:
Bass	Hip Hop	3053	FC_New Hip Hop_C	4/4	1	85			:
Bass	Hip Hop	3054	BA_New Hip Hop_C	4/4	1	85			:
Bass	Hip Hop	3055	EA_New Hip Hop_C	4/4	3	85			:
Bass	Hip Hop	3056	EB_New Hip Hop_C	4/4	3	85			:
Bass	Hip Hop	3057	MA_East Coast_C	4/4	2	103			:
Bass	Hip Hop	3058	MB_East Coast_C	4/4	2	103			:
Bass	Hip Hop	3059	MC_East Coast_C	4/4	2	103			:
Bass	Hip Hop	3060	MD_East Coast_C	4/4	2	103			:
Bass	Hip Hop	3061	MA_East Coast_N	4/4	2	103			:
Bass	Hip Hop	3062	MB_East Coast_N	4/4	2	103			:
Bass	Hip Hop	3063	MC_East Coast_N	4/4	2	103			:
Bass	Hip Hop	3064	MD_East Coast_N	4/4	2	103			:
Bass	Hip Hop	3065	MA_West Coast_C	4/4	2	97			:
Bass	Hip Hop	3066	MB_West Coast_C	4/4	2	97			:
Bass	Hip Hop	3067	MC_West Coast_C	4/4	2	97			:
Bass	Hip Hop	3068	MD_West Coast_C	4/4	2	97			:
Bass	Hip Hop	3069	MA_West Coast_N	4/4	2	97			:
Bass	Hip Hop	3070	MB_West Coast_N	4/4	2	97			:
Bass	Hip Hop	3071	MC_West Coast	4/4	2	97			:
Bass	Hip Hop	3072	MD_West Coast_N	4/4	2	97			:
Bass	Hip Hop	3073	MA_South Rap 1_C	4/4	4	98			:
Bass	Hip Hop	3074	MB_South Rap 1_C	4/4	4	98			:
Bass	Hip Hop	3075	MC_South Rap 1_C	4/4	4	98			:
Bass	Hip Hop	3076	MD_South Rap 1_C	4/4	4	98			:
Bass	Hip Hop	3077	MA_South Rap 1	4/4	4	98			:
Bass	Hip Hop	3078	MB_South Rap 1_N	4/4	4	98			:
Bass	Hip Hop	3079	MC_South Rap 1_N	4/4	4	98			:
Bass	Hip Hop	3080	MD_South Rap 1_N	4/4	4	98			:
Bass	Hip Hop	3081	MA_South Rap 2_C	4/4	2	90			:
Bass	Hip Hop	3082	MB_South Rap 2_C	4/4	2	90			:
Bass	Hip Hop	3083	MC_South Rap 2_C	4/4	2	90			:
Bass	Hip Hop	3084	MD_South Rap 2_C	4/4	2	90			:
Bass	Hip Hop	3085	MA_South Rap 2	4/4	2	90			:
Bass	Hip Hop	3086	MB_South Rap 2	4/4	2	90			:
Bass	Hip Hop	3087	MC_South Rap 2_N	4/4	2	90			:
Bass	Hip Hop	3088	MD_South Rap 2_N	4/4	2	90			:
Bass	Hip Hop	3089	MA_Hip Hop 1_N	4/4	2	105			:
Bass	Hip Hop	3090	MB_Hip Hop 1_N	4/4	2	105			:
Bass	Hip Hop	3091	MC_Hip Hop 1_N	4/4	2	105			:
Bass	Hip Hop	3092	MD_Hip Hop 1_N	4/4	2	105			:
Bass	Hip Hop	3093	FA_Hip Hop 1_N	4/4	1	105			:
Bass	Hip Hop	3094	FB_Hip Hop 1_N	4/4	1	105			:
Bass	Hip Hop	3095	FC_Hip Hop 1_N	4/4	2	105			:
Bass	Hip Hop	3096	MA_Hip Hop 2	4/4	2	94			:
Bass	Hip Hop	3097	MB_Hip Hop 2	4/4	2	94			:
Bass	Hip Hop	3098	MC_Hip Hop 2	4/4	2	94			:
Bass	Hip Hop	3099	MD_Hip Hop 2_N	4/4	2	94			:
Bass	Hip Hop	3100	FA_Hip Hop 2	4/4	1	94			:
Bass	Hip Hop	3101	FB_Hip Hop 2_N	4/4	1	94			:
Bass	Hip Hop	3102	FC_Hip Hop 2_N	4/4	2	94			:
Bass	Hip Hop	3103	MA_Hip Hop 3_N	4/4	2	104			:
Bass	Hip Hop	3104	MB_Hip Hop 3_N	4/4	2	104			:
Bass	Hip Hop	3105	MC_Hip Hop 3_N	4/4	2	104			:
Bass	Hip Hop	3106	MD_Hip Hop 3_N	4/4	2	104			:
Bass	Hip Hop	3107	FC_Hip Hop 3_N	4/4	2	104			:
Bass	Hip Hop	3108	MA_Hip Hop 5_C	4/4	2	103			:
Bass	Hip Hop	3109	MB_Hip Hop 5_C	4/4	4	103			:
Bass	Hip Hop	3110	MC_Hip Hop 5_C	4/4	2	103			:
Bass	Hip Hop	3111	MD_Hip Hop 5_C	4/4	2	103			:
Bass	Hip Hop	3112	MA_Hip Hop 5_N	4/4	2	103			:
Bass	Hip Hop	3113	MB_Hip Hop 5_N	4/4	4	103			:
Bass	Hip Hop	3114	MC_Hip Hop 5_N	4/4	2	103			:
Bass	Hip Hop	3115	MD_Hip Hop 5	4/4	2	103			:
Bass	Hip Hop	3116	MA_Hip Hop 6_C	4/4	4	96			:
Bass	Hip Hop	3117	MB_Hip Hop 6_C	4/4	4	96			:
Bass	Hip Hop	3118	MC_Hip Hop 6_C	4/4	4	96			:
Bass	Hip Hop	3119	FA_Hip Hop 6_C	4/4	1	96			:
Bass	Hip Hop	3120	FB_Hip Hop 6_C	4/4	1	96			:
Bass	Hip Hop	3121	FC_Hip Hop 6_C	4/4	1	96			:
Bass	Hip Hop	3122	BA_Hip Hop 6_C	4/4	1	96			:
Bass	Hip Hop	3123	MA_Hip Break_C	4/4	4	98			:
Bass	Hip Hop	3124	MB_Hip Break_C	4/4	4	98			:
Bass	Hip Hop	3125							

Arpeggio Type List

Main Category	Sub Category	ARP No.	ARP Name	Time Signature	Length	Original Tempo	Accent	Random SFX	Sound Type
Bass	Hip Hop	3132	MC_Hip Rock 1_C	4/4	4	90			:
Bass	Hip Hop	3133	FA_Hip Rock 1_C	4/4	1	90			:
Bass	Hip Hop	3134	FB_Hip Rock 1_C	4/4	1	90			:
Bass	Hip Hop	3135	MA_Hip Rock 2_C	4/4	4	132			Finger Bass
Bass	Hip Hop	3136	MB_Hip Rock 2_C	4/4	4	132			:
Bass	Hip Hop	3137	MC_Hip Rock 2_C	4/4	4	132			:
Bass	Hip Hop	3138	FA_Hip Rock 2_C	4/4	1	132			:
Bass	Hip Hop	3139	FB_Hip Rock 2_C	4/4	1	132			:
Bass	Hip Hop	3140	FC_Hip Rock 2_C	4/4	1	132			:
Bass	Hip Hop	3141	BA_Hip Rock 2_C	4/4	1	132			:
Bass	Hip Hop	3142	MA_Hip Reggae_C	4/4	4	92			Synth Bass
Bass	Hip Hop	3143	MB_Hip Reggae_C	4/4	4	92			:
Bass	Hip Hop	3144	MC_Hip Reggae_C	4/4	4	92			:
Bass	Hip Hop	3145	FA_Hip Reggae_C	4/4	1	92			:
Bass	Hip Hop	3146	FB_Hip Reggae_C	4/4	1	92			:
Bass	Hip Hop	3147	FC_Hip Reggae_C	4/4	1	92			:
Bass	Hip Hop	3148	MA_Regeton_C	4/4	4	98			:
Bass	Hip Hop	3149	MB_Regeton_C	4/4	4	98			:
Bass	Hip Hop	3150	MC_Regeton_C	4/4	4	98			:
Bass	Hip Hop	3151	FA_Regeton_C	4/4	1	98			:
Bass	Hip Hop	3152	FB_Regeton_C	4/4	1	98			:
Bass	Hip Hop	3153	FC_Regeton_C	4/4	1	98			:
Bass	Hip Hop	3154	BA_Regeton_C	4/4	1	98			:
Bass	Hip Hop	3155	MA_Dancehall_C	4/4	4	103			:
Bass	Hip Hop	3156	MB_Dancehall_C	4/4	4	103			:
Bass	Hip Hop	3157	MD_Dancehall_C	4/4	4	103			:
Bass	Hip Hop	3158	FA_Dancehall_C	4/4	1	103			:
Bass	Hip Hop	3159	FB_Dancehall_C	4/4	1	103			:
Bass	Hip Hop	3160	FD_Dancehall_C	4/4	1	103			:
Bass	Hip Hop	3161	BA_Dancehall_C	4/4	1	103			:
Bass	Hip Hop	3162	EA_Dancehall_C	4/4	3	103			:
Bass	Hip Hop	3163	MA_ClasticHipHop_N	4/4	2	90			:
Bass	Hip Hop	3164	MB_ClasticHipHop_N	4/4	2	90			:
Bass	Hip Hop	3165	MC_ClasticHipHop_N	4/4	2	90			:
Bass	Hip Hop	3166	MD_ClasticHipHop_N	4/4	2	90			:
Bass	Hip Hop	3167	FC_ClasticHipHop_N	4/4	1	90			:
Bass	Hip Hop	3168	MA_ElectroHipBs	4/4	4	70			:
Bass	Hip Hop	3169	MA_GruvBass	4/4	2	120			:
Bass	Modern R&B	3170	MA_Pop Shuffle2_C	4/4	4	94			Finger/Slap Bass
Bass	Modern R&B	3171	MB_Pop Shuffle2_C	4/4	4	94			:
Bass	Modern R&B	3172	MC_Pop Shuffle2_C	4/4	4	94			:
Bass	Modern R&B	3173	FA_Pop Shuffle2_C	4/4	1	94			:
Bass	Modern R&B	3174	FB_Pop Shuffle2_C	4/4	1	94			:
Bass	Modern R&B	3175	FC_Pop Shuffle2_C	4/4	1	94			:
Bass	Modern R&B	3176	BA_Pop Shuffle2_C	4/4	1	94			:
Bass	Modern R&B	3177	MA_Pop Shuffle2_N	4/4	4	94			:
Bass	Modern R&B	3178	MB_Pop Shuffle2_N	4/4	4	94			:
Bass	Modern R&B	3179	MC_Pop Shuffle2_N	4/4	4	94			:
Bass	Modern R&B	3180	FA_Pop Shuffle2_N	4/4	1	94			:
Bass	Modern R&B	3181	FB_Pop Shuffle2_N	4/4	1	94			:
Bass	Modern R&B	3182	FC_Pop Shuffle2_N	4/4	1	94			:
Bass	Modern R&B	3183	BA_Pop Shuffle2	4/4	1	94			:
Bass	Modern R&B	3184	MA_Pop Shuffle3_C	4/4	4	80			Pick Bass
Bass	Modern R&B	3185	MB_Pop Shuffle3_C	4/4	4	80			:
Bass	Modern R&B	3186	MC_Pop Shuffle3_C	4/4	4	80			:
Bass	Modern R&B	3187	FA_Pop Shuffle3_C	4/4	1	80			:
Bass	Modern R&B	3188	FB_Pop Shuffle3_C	4/4	1	80			:
Bass	Modern R&B	3189	FC_Pop Shuffle3_C	4/4	1	80			:
Bass	Modern R&B	3190	BA_Pop Shuffle3_C	4/4	1	80			:
Bass	Modern R&B	3191	MA_Pop Shuffle3_N	4/4	4	80			:
Bass	Modern R&B	3192	MB_Pop Shuffle3_N	4/4	4	80			:
Bass	Modern R&B	3193	MC_Pop Shuffle3_N	4/4	4	80			:
Bass	Modern R&B	3194	FA_Pop Shuffle3_N	4/4	1	80			:
Bass	Modern R&B	3195	FB_Pop Shuffle3_N	4/4	1	80			:
Bass	Modern R&B	3196	FC_Pop Shuffle3_N	4/4	1	80			:
Bass	Modern R&B	3197	BA_Pop Shuffle3	4/4	1	80			:
Bass	Modern R&B	3198	MA_R&B Disco_N	4/4	2	110			Synth Bass
Bass	Modern R&B	3199	MB_R&B Disco_N	4/4	2	110			:
Bass	Modern R&B	3200	MC_R&B Disco_N	4/4	2	110			:
Bass	Modern R&B	3201	MD_R&B Disco_N	4/4	2	110			:
Bass	Modern R&B	3202	FA_R&B Disco_N	4/4	1	110			:
Bass	Modern R&B	3203	FB_R&B Disco_N	4/4	1	110			:
Bass	Modern R&B	3204	FC_R&B Disco_N	4/4	2	110			:
Bass	Modern R&B	3205	MA_Chart R&B_C	4/4	4	130			:
Bass	Modern R&B	3206	MB_Chart R&B_C	4/4	4	130			:
Bass	Modern R&B	3207	MC_Chart R&B_C	4/4	4	130			:
Bass	Modern R&B	3208	FA_Chart R&B_C	4/4	1	130			:
Bass	Modern R&B	3209	FB_Chart R&B_C	4/4	1	130			:
Bass	Modern R&B	3210	FC_Chart R&B_C	4/4	1	130			:
Bass	Modern R&B	3211	BA_Chart R&B_C	4/4	1	130			:
Bass	Modern R&B	3212	EA_Chart R&B_C	4/4	5	130			:
Bass	Modern R&B	3213	EB_Chart R&B_C	4/4	10	130			:
Bass	Modern R&B	3214	MA_ChartPop1_C	4/4	4	92			:
Bass	Modern R&B	3215	MB_ChartPop1_C	4/4	4	92			:
Bass	Modern R&B	3216	MC_ChartPop1_C	4/4	4	92			:
Bass	Modern R&B	3217	FA_ChartPop1_C	4/4	1	92			:
Bass	Modern R&B	3218	FB_ChartPop1_C	4/4	1	92			:

Main Category	Sub Category	ARP No.	ARP Name	Time Signature	Length	Original Tempo	Accent	Random SFX	Sound Type
Bass	Modern R&B	3219	FC_ChartPop1_C	4/4	1	92			:
Bass	Modern R&B	3220	BA_ChartPop1_C	4/4	1	92			:
Bass	Modern R&B	3221	EA_ChartPop1_C	4/4	3	92			:
Bass	Modern R&B	3222	EB_ChartPop1_C	4/4	3	92			:
Bass	Modern R&B	3223	MA_ChartPop2_C	4/4	2	92			:
Bass	Modern R&B	3224	MB_ChartPop2_C	4/4	2	92			:
Bass	Modern R&B	3225	MC_ChartPop2_C	4/4	2	92			:
Bass	Modern R&B	3226	MD_ChartPop2_C	4/4	2	92			:
Bass	Modern R&B	3227	MA_ChartPop2	4/4	2	92			:
Bass	Modern R&B	3228	MB_ChartPop2	4/4	2	92			:
Bass	Modern R&B	3229	MC_ChartPop2	4/4	2	92			:
Bass	Modern R&B	3230	MD_ChartPop2_N	4/4	2	92			:
Bass	Modern R&B	3231	MA_R&B_C	4/4	2	83			:
Bass	Modern R&B	3232	MB_R&B_C	4/4	2	83			:
Bass	Modern R&B	3233	MC_R&B_C	4/4	2	83			:
Bass	Modern R&B	3234	FA_R&B_C	4/4	1	83			:
Bass	Modern R&B	3235	FB_R&B_C	4/4	1	83			:
Bass	Modern R&B	3236	FC_R&B_C	4/4	1	83			:
Bass	Modern R&B	3237	BA_R&B_C	4/4	1	83			:
Bass	Modern R&B	3238	EA_R&B_C	4/4	4	83			:
Bass	Modern R&B	3239	EB_R&B_C	4/4	4	83			:
Bass	Modern R&B	3240	MA_New R&B 1_C	4/4	2	98			:
Bass	Modern R&B	3241	MB_New R&B 1_C	4/4	2	98			:
Bass	Modern R&B	3242	MC_New R&B 1_C	4/4	2	98			:
Bass	Modern R&B	3243	FA_New R&B 1_C	4/4	1	98			:
Bass	Modern R&B	3244	FB_New R&B 1_C	4/4	1	98			:
Bass	Modern R&B	3245	FC_New R&B 1_C	4/4	1	98			:
Bass	Modern R&B	3246	BA_New R&B 1_C	4/4	1	98			:
Bass	Modern R&B	3247	EA_New R&B 1_C	4/4	3	98			:
Bass	Modern R&B	3248	EB_New R&B 1_C	4/4	4	98			:
Bass	Modern R&B	3249	MA_New R&B 2	4/4	1	97			:
Bass	Modern R&B	3250	MB_New R&B 2	4/4	1	97			:
Bass	Modern R&B	3251	MC_New R&B 2	4/4	1	97			:
Bass	Modern R&B	3252	MD_New R&B 2	4/4	1	97			:
Bass	Modern R&B	3253	IA_New R&B 2	4/4	2	97			:
Bass	Modern R&B	3254	FA_New R&B 2	4/4	1	97			:
Bass	Modern R&B	3255	FB_New R&B 2	4/4	1	97			:
Bass	Modern R&B	3256	FC_New R&B 2	4/4	2	97			:
Bass	Modern R&B	3257	MA_New R&B 3_N	4/4	2	90			:
Bass	Modern R&B	3258	MC_New R&B 3_N	4/4	2	90			:
Bass	Modern R&B	3259	MD_New R&B 3_N	4/4	2	90			:
Bass	Modern R&B	3260	IA_New R&B 3_N	4/4	2	90			:
Bass	Modern R&B	3261	FA_New R&B 3_N	4/4	1	90			:
Bass	Modern R&B	3262	FB_New R&B 3_N	4/4	1	90			:
Bass	Modern R&B	3263	FC_New R&B 3_N	4/4	2	90			:
Bass	Modern R&B	3264	MA_Pop R&B_C	4/4	4	67			:
Bass	Modern R&B	3265	MB_Pop R&B_C	4/4	4	67			:
Bass	Modern R&B	3266	MC_Pop R&B_C	4/4	4	67			:
Bass	Modern R&B	3267	FA_Pop R&B_C	4/4	1	67			:
Bass	Modern R&B	3268	FB_Pop R&B_C	4/4	1	67			:
Bass	Modern R&B	3269	FC_Pop R&B_C	4/4	1	67			:
Bass	Modern R&B	3270	BA_Pop R&B_C	4/4	1	67			:
Bass	Modern R&B	3271	MA_H-R&B Pop_C	4/4	4	140			:
Bass	Modern R&B	3272	MB_H-R&B Pop_C	4/4	4	140			:
Bass	Modern R&B	3273	MC_H-R&B Pop_C	4/4	4	140			:
Bass	Modern R&B	3274	FA_H-R&B Pop_C	4/4	1	140			:
Bass	Modern R&B	3275	FB_H-R&B Pop_C	4/4	1	140			:
Bass	Modern R&B	3276	FC_H-R&B Pop_C	4/4	1	140			:
Bass	Modern R&B	3277	MA_J-R&B Pop_C	4/4	4	100			:
Bass	Modern R&B	3278	MB_J-R&B Pop_C	4/4	4	100			:
Bass	Modern R&B	3279	MC_J-R&B Pop_C	4/4	4	100			:
Bass	Modern R&B	3280	FA_J-R&B Pop_C	4/4	1	100			:
Bass	Modern R&B	3281	FB_J-R&B Pop_C	4/4	1	100			:
Bass	Modern R&B	3282	FC_J-R&B Pop_C	4/4	1	100			:
Bass	Modern R&B	3283	MA_R&B Ana Pop_C	4/4	4	95			:
Bass	Modern R&B	3284	MB_R&B Ana Pop_C	4/4	4	95			:
Bass	Modern R&B	3285	MC_R&B Ana Pop_C	4/4	4	95			:
Bass	Modern R&B	3286	FA_R&B Ana Pop_C	4/4	1	95			:
Bass	Modern R&B	3287	FB_R&B Ana Pop_C	4/4	1	95			:
Bass	Modern R&B	3288	FC_R&B Ana Pop_C	4/4	1	95			:
Bass	Modern R&B	3289	BA_R&B Ana Pop_C	4/4	1	95			:
Bass	Modern R&B	3290	MA_R&B Ballad 1_C	4/4	4	70			:
Bass	Modern R&B	3291	MB_R&B Ballad 1_C	4/4	4	70			:
Bass	Modern R&B	3292	MC_R&B Ballad 1_C	4/4	4	70			:
Bass	Modern R&B	3293	FA_R&B Ballad 1_C	4/4	1	70			:

Arpeggio Type List

Main Category	Sub Category	ARP No.	ARP Name	Time Signature	Length	Original Tempo	Accent	Random SFX	Sound Type
Bass	Modern R&B	3306	MB_R&B Ballad 3_C	4/4	4	113			:
Bass	Modern R&B	3307	MC_R&B Ballad 3_C	4/4	4	113			:
Bass	Modern R&B	3308	FA_R&B Ballad 3_C	4/4	1	113			:
Bass	Modern R&B	3309	FB_R&B Ballad 3_C	4/4	1	113			:
Bass	Modern R&B	3310	FC_R&B Ballad 3_C	4/4	1	113			:
Bass	Modern R&B	3311	BA_R&B Ballad 3_C	4/4	1	113			:
Bass	Modern R&B	3312	MA_6/8 R&B_N	4/4	2	61			:
Bass	Modern R&B	3313	MC_6/8 R&B_N	4/4	2	61			:
Bass	Modern R&B	3314	MD_6/8 R&B_N	4/4	2	61			:
Bass	Modern R&B	3315	FA_6/8 R&B_N	4/4	1	61			:
Bass	Modern R&B	3316	FB_6/8 R&B_N	4/4	1	61			:
Bass	Modern R&B	3317	FC_6/8 R&B_N	4/4	2	61			:
Bass	Modern R&B	3318	MA_Smooth 1	4/4	2	115			:
Bass	Modern R&B	3319	MB_Smooth 1	4/4	2	115			:
Bass	Modern R&B	3320	MC_Smooth 1_N	4/4	2	115			:
Bass	Modern R&B	3321	MD_Smooth 1_N	4/4	2	115			:
Bass	Modern R&B	3322	FA_Smooth 1_N	4/4	1	115			:
Bass	Modern R&B	3323	FB_Smooth 1	4/4	1	115			:
Bass	Modern R&B	3324	FC_Smooth 1_N	4/4	2	115			:
Bass	Modern R&B	3325	MA_Flip Hop 1_N	4/4	2	132			Finger Bass
Bass	Modern R&B	3326	MB_Flip Hop 1_N	4/4	2	132			:
Bass	Modern R&B	3327	MC_Flip Hop 1_N	4/4	2	132			:
Bass	Modern R&B	3328	MD_Flip Hop 1_N	4/4	2	132			:
Bass	Modern R&B	3329	IA_Flip Hop 1_N	4/4	2	132			:
Bass	Modern R&B	3330	MA_New Gospel_N	4/4	2	90			Synth Bass
Bass	Modern R&B	3331	MB_New Gospel_N	4/4	2	90			:
Bass	Modern R&B	3332	MC_New Gospel_N	4/4	2	90			:
Bass	Modern R&B	3333	MD_New Gospel_N	4/4	2	90			:
Bass	Modern R&B	3334	FA_New Gospel_N	4/4	1	90			:
Bass	Modern R&B	3335	FC_New Gospel_N	4/4	2	90			:
Bass	Classic R&B	3336	MA_Soul 2_N	4/4	4	120			Finger Bass
Bass	Classic R&B	3337	MB_Soul 2_N	4/4	1	120			:
Bass	Classic R&B	3338	MC_Soul 2_N	4/4	4	120			:
Bass	Classic R&B	3339	MD_Soul 2_N	4/4	4	120			:
Bass	Classic R&B	3340	MA_Soul 3_C	4/4	4	88			Synth Bass
Bass	Classic R&B	3341	MB_Soul 3_C	4/4	4	88			:
Bass	Classic R&B	3342	MC_Soul 3_C	4/4	4	88			:
Bass	Classic R&B	3343	MD_Soul 3_C	4/4	4	88			:
Bass	Classic R&B	3344	MA_Soul 3_N	4/4	4	88			:
Bass	Classic R&B	3345	MB_Soul 3_N	4/4	4	88			:
Bass	Classic R&B	3346	MC_Soul 3_N	4/4	4	88			:
Bass	Classic R&B	3347	MD_Soul 3	4/4	4	88			:
Bass	Classic R&B	3348	MA_Soul Beat_C	4/4	4	124			Finger Bass
Bass	Classic R&B	3349	MB_Soul Beat_C	4/4	4	124			:
Bass	Classic R&B	3350	MC_Soul Beat_C	4/4	4	124			:
Bass	Classic R&B	3351	FA_Soul Beat_C	4/4	1	124			:
Bass	Classic R&B	3352	FB_Soul Beat_C	4/4	1	124			:
Bass	Classic R&B	3353	FC_Soul Beat_C	4/4	1	124			:
Bass	Classic R&B	3354	BA_Soul Beat_C	4/4	1	124			:
Bass	Classic R&B	3355	EA_Soul Beat_C	4/4	3	123			:
Bass	Classic R&B	3356	EB_Soul Beat_C	4/4	3	123			:
Bass	Funk	3357	MA_Slep Up Bass_N	4/4	8	130			Acoustic Bass
Bass	Funk	3358	MA_PushButtonBs_N	4/4	2	115			Synth Bass
Bass	Funk	3359	MA_Frozen Yogurt	4/4	1	120			:
Bass	Funk	3360	MA_Funk 3_N	4/4	2	132			Finger Bass
Bass	Funk	3361	MB_Funk 3_N	4/4	2	132			:
Bass	Funk	3362	MC_Funk 3_N	4/4	4	132			:
Bass	Funk	3363	MD_Funk 3_N	4/4	4	132			:
Bass	Funk	3364	IA_Funk 3	4/4	1	132			:
Bass	Funk	3365	FB_Funk 3_N	4/4	1	132			:
Bass	Funk	3366	MA1_Cool Funk_N	4/4	2	96			:
Bass	Funk	3367	MB1_Cool Funk_N	4/4	2	96			:
Bass	Funk	3368	MC1_Cool Funk_N	4/4	2	96			:
Bass	Funk	3369	MD1_Cool Funk_N	4/4	4	96			:
Bass	Funk	3370	IA1_Cool Funk_N	4/4	2	96			:
Bass	Funk	3371	FA1_Cool Funk_N	4/4	1	96			:
Bass	Funk	3372	FB1_Cool Funk_N	4/4	1	96			:
Bass	Funk	3373	FC1_Cool Funk_N	4/4	1	96			:
Bass	Funk	3374	MA2_Cool Funk_N	4/4	2	96			:
Bass	Funk	3375	MB2_Cool Funk_N	4/4	2	96			:
Bass	Funk	3376	MC2_Cool Funk_N	4/4	2	96			:
Bass	Funk	3377	MD2_Cool Funk_N	4/4	4	96			:
Bass	Funk	3378	IA2_Cool Funk_N	4/4	2	96			:
Bass	Funk	3379	FA2_Cool Funk_N	4/4	1	96			:
Bass	Funk	3380	FB2_Cool Funk_N	4/4	1	96			:
Bass	Funk	3381	FC2_Cool Funk_N	4/4	1	96			:
Bass	Funk	3382	MA_Jazz Funk 2_N	4/4	2	120			:
Bass	Funk	3383	MB_Jazz Funk 2_N	4/4	4	120			:
Bass	Funk	3384	MC_Jazz Funk 2_N	4/4	4	120			:
Bass	Funk	3385	MD_Jazz Funk 2_N	4/4	4	120			:
Bass	Funk	3386	FA_Jazz Funk 2_N	4/4	1	120			:
Bass	Funk	3387	MA_Jazz Funk 3_C	4/4	4	123			Synth Bass
Bass	Funk	3388	MB_Jazz Funk 3_C	4/4	4	123			:
Bass	Funk	3389	MC_Jazz Funk 3_C	4/4	4	123			:
Bass	Funk	3390	MD_Jazz Funk 3_C	4/4	2	123			:
Bass	Funk	3391	MA_Jazz Funk 3_N	4/4	4	123			:
Bass	Funk	3392	MB_Jazz Funk 3_N	4/4	4	123			:

Main Category	Sub Category	ARP No.	ARP Name	Time Signature	Length	Original Tempo	Accent	Random SFX	Sound Type
Bass	Funk	3393	MC_Jazz Funk 3_N	4/4	4	123			:
Bass	Funk	3394	MD_Jazz Funk 3_N	4/4	2	123			:
Bass	Funk	3395	MA_Club Jazz 1_C	4/4	4	125			Finger Bass
Bass	Funk	3396	MB_Club Jazz 1_C	4/4	4	125			:
Bass	Funk	3397	MC_Club Jazz 1_C	4/4	4	125			:
Bass	Funk	3398	FA_Club Jazz 1_C	4/4	1	125			:
Bass	Funk	3399	FB_Club Jazz 1_C	4/4	1	125			:
Bass	Funk	3400	FC_Club Jazz 1_C	4/4	1	125			:
Bass	Funk	3401	BA_Club Jazz 1_C	4/4	1	125			:
Bass	Funk	3402	MA_Club Jazz 2_C	4/4	4	125			:
Bass	Funk	3403	MB_Club Jazz 2_N	4/4	4	125			:
Bass	Funk	3404	MC_Club Jazz 2_N	4/4	4	125			:
Bass	Funk	3405	FA_Club Jazz 1	4/4	1	125			:
Bass	Funk	3406	FB_Club Jazz 1_N	4/4	1	125			:
Bass	Funk	3407	FC_Club Jazz 1_N	4/4	1	125			:
Bass	Funk	3408	BA_Club Jazz 1	4/4	1	125			:
Bass	Funk	3409	MA_Club Jazz 2_C	4/4	4	92			:
Bass	Funk	3410	MB_Club Jazz 2_C	4/4	4	92			:
Bass	Funk	3411	MC_Club Jazz 2_C	4/4	4	92			:
Bass	Funk	3412	FA_Club Jazz 2_C	4/4	1	92			:
Bass	Funk	3413	FB_Club Jazz 2_C	4/4	1	92			:
Bass	Funk	3414	FC_Club Jazz 2_C	4/4	1	92			:
Bass	Funk	3415	BA_Club Jazz 2_C	4/4	1	92			:
Bass	Funk	3416	MA_Club Jazz 2_N	4/4	4	92			:
Bass	Funk	3417	MB_Club Jazz 2_N	4/4	4	92			:
Bass	Funk	3418	MC_Club Jazz 2_N	4/4	4	92			:
Bass	Funk	3419	FA_Club Jazz 2	4/4	1	92			:
Bass	Funk	3420	FB_Club Jazz 2_N	4/4	1	92			:
Bass	Funk	3421	FC_Club Jazz 2_N	4/4	1	92			:
Bass	Funk	3422	BA_Club Jazz 2	4/4	1	92			:
Bass	Funk	3423	MA_FingerBass1_N	4/4	1	115			:
Bass	Funk	3424	MA_FingerBass2_N	4/4	1	115			:
Bass	Funk	3425	MA_FingerBass3_N	4/4	3	115			:
Bass	Funk	3426	MA_FingerBass4_N	4/4	1	115			:
Bass	Funk	3427	MA_FingerBass5_N	4/4	1	115			:
Bass	Funk	3428	MA_FingerBass6_N	4/4	1	115			:
Bass	Funk	3429	MA_FingerBass7_N	4/4	2	120			:
Bass	Funk	3430	MA_FingerBass8_N	4/4	2	150			:
Bass	Funk	3431	MA_FingerBass9_N	4/4	2	150			:
Bass	Funk	3432	MA_FingerBass10_N	4/4	2	89			:
Bass	Funk	3433	MA_FingerBass11_N	4/4	2	89			:
Bass	Funk	3434	MA_FingerBass12_N	4/4	1	115			:
Bass	Funk	3435	MA_FingerBass13_N	4/4	1	115			:
Bass	Funk	3436	MA_FingerBass14_N	4/4	1	115			:
Bass	Funk	3437	MA_FingerBass15_N	4/4	4	107			:
Bass	Funk	3438	MA_FingerBass16_N	4/4	4	107			:
Bass	Funk	3439	MA_FingerBass17_N	4/4	4	107			:
Bass	Funk	3440	MA_FingerBass18_N	4/4	4	107			:
Bass	Funk	3441	MA_FingerBass19_N	4/4	4	107			:
Bass	Funk	3442	MA_Slap Bass1	4/4	4	120			Slap Bass
Bass	Funk	3443	MA_Slap Bass2	4/4	2	120			:
Bass	Funk	3444	MA_Slap Bass3_N	4/4	1	124			:
Bass	Funk	3445	MA_Slap Bass4_N	4/4	1	124			:
Bass	Funk	3446	MA_Slap Bass5_N	4/4	2	124			:
Bass	Funk	3447	MA_Slap Bass6_N	4/4	1	105			:
Bass	Funk	3448	MA_Slap Bass7_N	4/4	1	105			:
Bass	Funk	3449	MA_Slap Bass8_N	4/4	1	105			:
Bass	Funk	3450	MA_Slap Bass9_N	4/4	2	110			:
Bass	Funk	3451	MA_Slap Bass10_N	4/4	1	110			:
Bass	Funk	3452	MA_Slap Bass11_N	4/4	1	90			:
Bass	Funk	3453	MA_Slap Bass12_N	4/4	3	120			:
Bass	Funk	3454	MA_Slap Bass13_N	4/4	1	120			:
Bass	Techno	3455	MA_Synth Bass6-01	4/4	8	130			Synth Bass
Bass	Techno	3456	MA_Synth Bass6-02	4/4	8	130			:
Bass	Techno	3457	MA_Synth Bass6-03	4/4	2	130			:
Bass	Techno	3458	MA_Synth Bass6-04	4/4	2	130			:
Bass	Techno	3459	MA_Synth Bass6-05	4/4	1	130			:
Bass	Techno	3460	MA_Synth Bass6-06	4/4	1	130			:
Bass	Techno	3461	MA_Synth Bass6-07	4/4	2	130			:
Bass	Techno	3462	MA_Synth Bass6-08	4/4	1	130			:
Bass	Techno	3463	MA_Synth Bass6-09	4/4	1	130			:
Bass	Techno	3464	MA_SynthBass6-10_N	4/4	4	130			:
Bass	Techno	3465	MA_SynthBass6-11_N	4/4	4	130			:
Bass	Techno	3466	MA_Synth Bass6-11	4/4	4	130			:
Bass	Techno	3467	MA_Synth Bass6-12	4/4	2	130			:
Bass	Techno	3468	MA_SyBsRiff2-01	4/4	1	130			:
Bass	Techno	3469	MA_SyBsRiff2-02	4/4	2	130			:
Bass	Techno	3470	MA_SyBsRiff2-03_N	4/4	2	130			:
Bass	Techno								

Main Category	Sub Category	ARP No.	ARP Name	Time Signature	Length	Original Tempo	Accent	Random SFX	Sound Type
Bass	Techno	3480	FB_Techno 1_N	4/4	1	135			:
Bass	Techno	3481	FC_Techno 1_N	4/4	1	135			:
Bass	Techno	3482	BA_Techno 1	4/4	3	135			:
Bass	Techno	3483	MB_Techno 2	4/4	4	137			Finger Bass
Bass	Techno	3484	MC_Techno 2_N	4/4	4	137			Synth Bass
Bass	Techno	3485	FA_Techno 2_N	4/4	1	137			:
Bass	Techno	3486	FB_Techno 2	4/4	2	137			Finger Bass
Bass	Techno	3487	BA_Techno 2_N	4/4	4	137			Synth Bass
Bass	Techno	3488	MA_Trance 1_C	4/4	8	142			:
Bass	Techno	3489	MB_Trance 1_C	4/4	4	142			:
Bass	Techno	3490	MC_Trance 1_C	4/4	16	142			:
Bass	Techno	3491	FA_Trance 1_C	4/4	2	142			:
Bass	Techno	3492	FB_Trance 1_C	4/4	8	142			:
Bass	Techno	3493	FC_Trance 1_C	4/4	8	142			:
Bass	Techno	3494	MA_Trance 1_N	4/4	8	142			:
Bass	Techno	3495	MB_Trance 1_N	4/4	4	142			:
Bass	Techno	3496	MC_Trance 1_N	4/4	16	142			:
Bass	Techno	3497	FA_Trance 1_N	4/4	2	142			:
Bass	Techno	3498	FB_Trance 1_N	4/4	8	142			:
Bass	Techno	3499	FC_Trance 1_N	4/4	8	142			:
Bass	Techno	3500	MA_Trance 2_C	4/4	8	135			:
Bass	Techno	3501	MB_Trance 2_C	4/4	8	135			:
Bass	Techno	3502	MC_Trance 2_C	4/4	8	135			:
Bass	Techno	3503	FA_Trance 2_C	4/4	1	135			:
Bass	Techno	3504	FB_Trance 2_C	4/4	8	135			:
Bass	Techno	3505	FC_Trance 2_C	4/4	1	135			:
Bass	Techno	3506	BA_Trance 2_C	4/4	1	135			:
Bass	Techno	3507	MA_Trance 2_N	4/4	8	135			:
Bass	Techno	3508	MB_Trance 2_N	4/4	8	135			:
Bass	Techno	3509	MC_Trance 2_N	4/4	8	135			:
Bass	Techno	3510	FA_Trance 2_N	4/4	1	135			:
Bass	Techno	3511	FB_Trance 2_N	4/4	8	135			:
Bass	Techno	3512	FC_Trance 2_N	4/4	1	135			:
Bass	Techno	3513	BA_Trance 2_N	4/4	1	135			:
Bass	Techno	3514	MA_Trance 3_C	4/4	2	140			:
Bass	Techno	3515	MB_Trance 3_C	4/4	2	140			:
Bass	Techno	3516	MC_Trance 3_C	4/4	3	140			:
Bass	Techno	3517	FA_Trance 3_C	4/4	2	140			:
Bass	Techno	3518	FB_Trance 3_C	4/4	2	140			:
Bass	Techno	3519	FC_Trance 3_C	4/4	4	140			:
Bass	Techno	3520	BA_Trance 3_C	4/4	1	140			:
Bass	Techno	3521	MA_Trance 3_N	4/4	2	140			:
Bass	Techno	3522	MB_Trance 3_N	4/4	2	140			:
Bass	Techno	3523	MC_Trance 3_N	4/4	3	140			:
Bass	Techno	3524	FA_Trance 3_N	4/4	2	140			:
Bass	Techno	3525	FB_Trance 3_N	4/4	2	140			:
Bass	Techno	3526	FC_Trance 3_N	4/4	4	140			:
Bass	Techno	3527	BA_Trance 3_N	4/4	1	140			:
Bass	Techno	3528	MA_Trance 4_C	4/4	4	130			:
Bass	Techno	3529	MB_Trance 4_C	4/4	2	130			:
Bass	Techno	3530	MC_Trance 4_C	4/4	4	130			:
Bass	Techno	3531	FA_Trance 4_C	4/4	4	130			:
Bass	Techno	3532	FB_Trance 4_C	4/4	2	130			:
Bass	Techno	3533	FC_Trance 4_C	4/4	4	130			:
Bass	Techno	3534	BA_Trance 4_C	4/4	2	130			:
Bass	Techno	3535	MA_Trance 4_N	4/4	4	130			:
Bass	Techno	3536	MB_Trance 4	4/4	2	130			:
Bass	Techno	3537	MC_Trance 4_N	4/4	4	130			:
Bass	Techno	3538	FA_Trance 4_N	4/4	4	130			:
Bass	Techno	3539	FB_Trance 4_N	4/4	2	130			:
Bass	Techno	3540	FC_Trance 4_N	4/4	4	130			:
Bass	Techno	3541	BA_Trance 4_N	4/4	2	130			:
Bass	Techno	3542	MA_Trance 5	4/4	1	140			:
Bass	Techno	3543	FA_Trance 5_N	4/4	1	140			:
Bass	Techno	3544	FC_Trance 5_N	4/4	4	140			:
Bass	Techno	3545	MA_TranceBassA1_N	4/4	2	143			:
Bass	Techno	3546	MA_TranceBassA2_N	4/4	1	143			:
Bass	Techno	3547	MA_TranceBassA3_N	4/4	1	143			:
Bass	Techno	3548	MA_TranceBassA4_N	4/4	1	143			:
Bass	Techno	3549	MA_TranceBassA5_N	4/4	1	143			:
Bass	Techno	3550	MA_TranceBassB1	4/4	1	143			:
Bass	Techno	3551	MA_TranceBassB2_N	4/4	1	143			:
Bass	Techno	3552	MA_TranceBassB3_N	4/4	1	143			:
Bass	Techno	3553	MA_TranceBassB4_N	4/4	1	143			:
Bass	Techno	3554	MA_TranceBassB5_N	4/4	1	143			:
Bass	Techno	3555	MA_Trance Vision	4/4	1	134			:
Bass	Techno	3556	MB_Trance Vision	4/4	1	134			:
Bass	Techno	3557	MC_Trance Vision	4/4	1	134			:
Bass	Techno	3558	MD_Trance Vision	4/4	1	134			:
Bass	Techno	3559	MA_Dream Trance	4/4	1	140			:
Bass	Techno	3560	MB_Dream Trance	4/4	1	140			:
Bass	Techno	3561	MC_Dream Trance	4/4	1	140			:
Bass	Techno	3562	MA_Electrix	4/4	1	119			:
Bass	Techno	3563	MB_Electrix	4/4	1	119			:
Bass	Techno	3564	MC_Electrix	4/4	1	119			:
Bass	Techno	3565	MA_Cool Breakz	4/4	1	116			:
Bass	Techno	3566	MB_Cool Breakz	4/4	1	116			:

Main Category	Sub Category	ARP No.	ARP Name	Time Signature	Length	Original Tempo	Accent	Random SFX	Sound Type
Bass	Techno	3567	MA_Synthlines	4/4	1	124			:
Bass	Techno	3568	MB_Synthlines	4/4	1	124			:
Bass	Techno	3569	MC_Synthlines	4/4	1	124			:
Bass	Techno	3570	MA_Noize Xpress	4/4	4	70			:
Bass	Techno	3571	MA_Tek Bass1	4/4	1	138			:
Bass	Techno	3572	MA_Tek Bass2	4/4	1	138			:
Bass	Techno	3573	MA_Tek Bass3	4/4	8	138			:
Bass	Techno	3574	MA_Acid Bass1	4/4	1	86			:
Bass	Techno	3575	MA_Acid Bass2	4/4	1	120			:
Bass	Techno	3576	MA_Acid Flux	4/4	1	130			:
Bass	Techno	3577	MA_Octaver	4/4	1	120			:
Bass	Techno	3578	MA_Twister	4/4	1	135			:
Bass	Techno	3579	MA_Cyborg	4/4	1	90			:
Bass	Techno	3580	MA_LoRidr	4/4	1	90			:
Bass	Techno	3581	MA_Kronic	4/4	1	100			:
Bass	Techno	3582	MA_Triplet	4/4	1	120			:
Bass	Techno	3583	MA_Tronica	4/4	1	120			:
Bass	Techno	3584	MA_Wazzo	4/4	1	94			:
Bass	Techno	3585	MA_Swing Bass	4/4	2	132			:
Bass	Techno	3586	MA_Synth Bass1_N	4/4	1	120			:
Bass	Techno	3587	MA_Synth Bass2_N	4/4	1	120			:
Bass	Techno	3588	MA_Synth Bass3_N	4/4	1	120			:
Bass	Techno	3589	MA_Synth Bass4_N	4/4	1	120			:
Bass	Techno	3590	MA_Synth Bass5_N	4/4	1	120			:
Bass	House	3591	MA_SynthBass7-01_N	4/4	2	130			:
Bass	House	3592	MA_Synth Bass7-01	4/4	2	130			:
Bass	House	3593	MA_SynthBass7-02_N	4/4	2	130			:
Bass	House	3594	MA_Synth Bass7-02	4/4	2	130			:
Bass	House	3595	MA_SynthBass7-03_N	4/4	1	130			:
Bass	House	3596	MA_Synth Bass7-03	4/4	1	130			:
Bass	House	3597	MA_SynthBass7-04_N	4/4	1	130			:
Bass	House	3598	MA_Synth Bass7-04	4/4	1	130			:
Bass	House	3599	MA_Synth Bass7-05	4/4	4	130			:
Bass	House	3600	MA_Synth Bass7-06	4/4	2	130			:
Bass	House	3601	MA_Synth Bass7-07	4/4	2	130			:
Bass	House	3602	MA_Synth Bass7-08	4/4	2	130			:
Bass	House	3603	MA_Synth Bass7-09	4/4	2	130			:
Bass	House	3604	MA_Synth Bass7-10	4/4	2	130			:
Bass	House	3605	MA_SynthBass8-01_N	4/4	2	122			:
Bass	House	3606	MA_Synth Bass8-01	4/4	2	122			:
Bass	House	3607	MA_SynthBass8-02_N	4/4	2	128			:
Bass	House	3608	MA_Synth Bass8-02	4/4	2	128			:
Bass	House	3609	MA_SynthBass8-03_N	4/4	2	128			:
Bass	House	3610	MA_Synth Bass8-03	4/4	2	128			:
Bass	House	3611	MA_SynthBass8-04_N	4/4	2	120			:
Bass	House	3612	MA_Synth Bass8-04	4/4	2	120			:
Bass	House	3613	MA_SynthBass8-05_N	4/4	2	125			:
Bass	House	3614	MA_Synth Bass8-05	4/4	2	125			:
Bass	House	3615	MA_SynthBass8-06_N	4/4	2	125			:
Bass	House	3616	MA_Synth Bass8-06	4/4	2	125			:
Bass	House	3617	MA_SynthBass8-07_N	4/4	4	122			:
Bass	House	3618	MA_Synth Bass8-07	4/4	4	122			:
Bass	House	3619	MA_Synth Bass8-08	4/4	2	128			:
Bass	House	3620	MA_SynthBass8-09_N	4/4	2	120			:
Bass	House	3621	MA_Synth Bass8-09	4/4	2	120			:
Bass	House	3622	MA_SynthBass8-10_N	4/4	4	128			:
Bass	House	3623	MA_Synth Bass8-10	4/4	4	128			:
Bass	House	3624	MA_Synth Bass8-11a	4/4	4	122			:
Bass	House	3625	MA_Synth Bass8-11b	4/4	4	122			:
Bass	House	3626	MA_Synth Bass8-12	4/4	2	122			:
Bass	House	3627	MA_SynthBass8-13_N	4/4	1	128			:
Bass	House	3628	MA_Synth Bass8-13	4/4	1	128			:
Bass	House	3629	MA_Synth Bass8-14a	4/4	2	122			:
Bass	House	3630	MA_Synth Bass8-14b	4/4	2	122			:
Bass	House	3631	MA_SynthBass8-15_N	4/4	4	122			:
Bass	House	3632	MA_Synth Bass8-15	4/4	4	122			:
Bass	House	3633	MA_SyBsRiff3-01_N	4/4	4	130			:
Bass	House	3634	MA_SyBsRiff3-01	4/4	4	130			:
Bass	House	3635	MA_SyBsRiff3-02	4/4	2	130			:
Bass	House	3636	MA_SyBsRiff3-03	4/4	4	130			:
Bass	House	3637	MA_SyBsRiff3-04_N	4/4	2	130			:
Bass	House	3638	MA_SyBsRiff3-04	4/4	2	130			:
Bass	House	3639	MA_SyBsRiff3-05_N	4/4	2	130			:
Bass	House	3640	MA_SyBsRiff3-06	4/4	2	130			:
Bass	House	3641	MA_SyBsRiff3-07_N	4/4	2	130			:
Bass	House	3642	MA_SyBsRiff3-08_N	4/4	2	130			:
Bass	House	3643	MA_SyBsRiff3-09_N	4/4	2	130			:
Bass	House	3644	MA_SyBsRiff3-10_N	4/4	2	130			:
Bass	House	3645	MA_SyBsRiff3-10	4/4	2	130			:
Bass	House</								

Arpeggio Type List

Main Category	Sub Category	ARP No.	ARP Name	Time Signature	Length	Original Tempo	Accent	Random SFX	Sound Type
Bass	House	3654	MA_Cosmic Heart Bs	4/4	2	122			:
Bass	House	3655	MA_Deep N Low Bass	4/4	2	122			:
Bass	House	3656	MA_EmoDM Bass	4/4	4	120			:
Bass	House	3657	MA_Epoque Bass	4/4	2	122			:
Bass	House	3658	MA_Funky Walk Bass	4/4	2	112			:
Bass	House	3659	MA_In My House Bass	4/4	2	117			:
Bass	House	3660	MA_Make Me Sing Bs	4/4	2	126			:
Bass	House	3661	MA_Organa Bass	4/4	2	110			:
Bass	House	3662	MA_Play Thing Bass	4/4	2	110			:
Bass	House	3663	MA_PlayThingWobble	4/4	2	110			:
Bass	House	3664	MA_Rodeo Bass	4/4	2	120			:
Bass	House	3665	MA_Back Two One_N	4/4	1	120			:
Bass	House	3666	MA_Den Haag_N	4/4	2	120			:
Bass	House	3667	MA_Around Us_N	4/4	1	120			:
Bass	House	3668	MA_Dream Dance_N	4/4	2	136			:
Bass	House	3669	MB_Dream Dance	4/4	1	136			:
Bass	House	3670	MC_Dream Dance_N	4/4	4	136			:
Bass	House	3671	MD_Dream Dance_N	4/4	4	136			:
Bass	House	3672	FA_Dream Dance_N	4/4	1	136			:
Bass	House	3673	MA_Ibiza	4/4	2	135			:
Bass	House	3674	MB_Ibiza	4/4	2	135			:
Bass	House	3675	MC_Ibiza_N	4/4	2	135			:
Bass	House	3676	MD_Ibiza_N	4/4	2	135			:
Bass	House	3677	IA_Ibiza	4/4	1	135			:
Bass	House	3678	FC_Ibiza_N	4/4	4	135			:
Bass	House	3679	MA_Retro Pop_N	4/4	2	126			:
Bass	House	3680	MA_Disco House_C	4/4	4	126			:
Bass	House	3681	MB_Disco House_C	4/4	4	126			:
Bass	House	3682	MC_Disco House_C	4/4	4	126			:
Bass	House	3683	FA_Disco House_C	4/4	1	126			:
Bass	House	3684	FB_Disco House_C	4/4	1	126			:
Bass	House	3685	FC_Disco House_C	4/4	1	126			:
Bass	House	3686	BA_Disco House_C	4/4	1	126			:
Bass	House	3687	MA_Club House_N	4/4	1	128			:
Bass	House	3688	MB_Club House_N	4/4	1	128			:
Bass	House	3689	MC_Club House_N	4/4	1	128			:
Bass	House	3690	MD_Club House_N	4/4	1	128			:
Bass	House	3691	IA_Club House_N	4/4	1	128			:
Bass	House	3692	FA_Club House_N	4/4	1	128			:
Bass	House	3693	FB_Club House_N	4/4	1	128			:
Bass	House	3694	MA_Garage 2_N	4/4	2	127			:
Bass	House	3695	MB_Garage 2_N	4/4	2	127			:
Bass	House	3696	MC_Garage 2_N	4/4	2	127			:
Bass	House	3697	MD_Garage 2_N	4/4	2	127			:
Bass	House	3698	IA_Garage 2_N	4/4	2	127			:
Bass	House	3699	FC_Garage 2_N	4/4	2	127			:
Bass	House	3700	MA_House Bass	4/4	4	120			:
Bass	D&B	3701	MA_Big Bass Wobble	4/4	2	140			:
Bass	D&B	3702	MA_Big Open Wobble	4/4	2	120			:
Bass	D&B	3703	MA_Hit Wobble	4/4	2	140			:
Bass	D&B	3704	MA_Dubtastic Wobble	4/4	2	140			:
Bass	D&B	3705	MA_Big Beat 1_N	4/4	4	115			Finger Bass
Bass	D&B	3706	MB_Big Beat 1_N	4/4	4	115			:
Bass	D&B	3707	MC_Big Beat 1_N	4/4	4	115			:
Bass	D&B	3708	FA_Big Beat 1	4/4	1	115			:
Bass	D&B	3709	FB_Big Beat 1	4/4	1	115			:
Bass	D&B	3710	FC_Big Beat 1	4/4	1	115			:
Bass	D&B	3711	BA_Big Beat 1	4/4	1	115			:
Bass	D&B	3712	MA_Breakbeats 1	4/4	4	115			Synth Bass
Bass	D&B	3713	MB_Breakbeats 1_N	4/4	4	115			:
Bass	D&B	3714	MC_Breakbeats 1_N	4/4	2	115			:
Bass	D&B	3715	FA_Breakbeats 1	4/4	1	115			:
Bass	D&B	3716	FB_Breakbeats 1	4/4	1	115			:
Bass	D&B	3717	FC_Breakbeats 1_N	4/4	1	115			:
Bass	D&B	3718	BA_Breakbeats 1	4/4	1	115			:
Bass	D&B	3719	MA_Breakbeats 2_N	4/4	4	88			:
Bass	D&B	3720	MB_Breakbeats 2_N	4/4	4	88			:
Bass	D&B	3721	MC_Breakbeats 2_N	4/4	4	88			:
Bass	D&B	3722	FA_Breakbeats 2	4/4	1	88			:
Bass	D&B	3723	FB_Breakbeats 2_N	4/4	1	88			:
Bass	D&B	3724	FC_Breakbeats 2_N	4/4	1	88			:
Bass	D&B	3725	BA_Breakbeats 2_N	4/4	1	88			:
Bass	Chill	3726	MA_EDM Ballad Bass	4/4	4	120			:
Bass	Chill	3727	MA_Ambient 1_C	4/4	4	102			:
Bass	Chill	3728	MB_Ambient 1_C	4/4	4	102			:
Bass	Chill	3729	MC_Ambient 1_C	4/4	4	102			:
Bass	Chill	3730	FA_Ambient 1_C	4/4	1	102			:
Bass	Chill	3731	FC_Ambient 1_C	4/4	1	102			:
Bass	Chill	3732	MA_Ambient 1_N	4/4	4	102			:
Bass	Chill	3733	MB_Ambient 1_N	4/4	4	102			:
Bass	Chill	3734	MC_Ambient 1_N	4/4	4	102			:
Bass	Chill	3735	FA_Ambient 1_N	4/4	1	102			:
Bass	Chill	3736	FC_Ambient 1_N	4/4	1	102			:
Bass	Chill	3737	MA_Ambient 2_C	4/4	4	111			:
Bass	Chill	3738	MB_Ambient 2_C	4/4	2	111			:
Bass	Chill	3739	MC_Ambient 2_C	4/4	4	111			:
Bass	Chill	3740	FA_Ambient 2_C	4/4	1	111			:

Main Category	Sub Category	ARP No.	ARP Name	Time Signature	Length	Original Tempo	Accent	Random SFX	Sound Type
Bass	Chill	3741	FB_Ambient 2_C	4/4	8	111			:
Bass	Chill	3742	FC_Ambient 2_C	4/4	1	111			:
Bass	Chill	3743	BA_Ambient 2_C	4/4	2	111			:
Bass	Chill	3744	MA_Ambient 2_N	4/4	4	111			:
Bass	Chill	3745	MB_Ambient 2	4/4	2	111			:
Bass	Chill	3746	MC_Ambient 2_N	4/4	4	111			:
Bass	Chill	3747	FA_Ambient 2_N	4/4	1	111			:
Bass	Chill	3748	FB_Ambient 2_N	4/4	8	111			:
Bass	Chill	3749	FC_Ambient 2_N	4/4	1	111			:
Bass	Chill	3750	BA_Ambient 2_N	4/4	2	111			:
Bass	Chill	3751	MB_Chill Out	4/4	2	79			:
Bass	Chill	3752	MC_Chill Out_N	4/4	4	79			:
Bass	Chill	3753	MD_Chill Out_N	4/4	1	79			Finger Bass
Bass	Chill	3754	IA_Chill Out_N	4/4	3	79			:
Bass	Chill	3755	FA_Chill Out_N	4/4	1	79			Finger Bass (PB Range=12)
Bass	Chill	3756	FC_Chill Out_N	4/4	4	79			Finger Bass
Bass	Chill	3757	MA_ChillKitBass	4/4	4	70			Synth Bass
Bass	Chill	3758	MA_ClublechBas1	4/4	1	70			:
Bass	Chill	3759	MA_ClublechBas2	4/4	1	70			:
Bass	Chill	3760	MA_ClublechBas3	4/4	1	70			:
Bass	Chill	3761	MA_HeavyChillBs	4/4	4	70			:
Bass	Chill	3762	MA_HeartbreakBs	4/4	4	70			:
Bass	Chill	3763	MA_PopBreaksBas	4/4	4	70			:
Bass	Chill	3764	MB_Synth Pop	4/4	2	90			:
Bass	Chill	3765	MD_Synth Pop	4/4	2	90			:
Bass	Chill	3766	FC_Synth Pop	4/4	2	90			:
Bass	Chill	3767	MA_Eighties	4/4	1	120			:
Bass	Chill	3768	MA_Eighties AF1	4/4	1	120			:
Bass	Chill	3769	MB_Eighties	4/4	1	120			:
Bass	Chill	3770	MC_Eighties AF1	4/4	1	120			:
Bass	Chill	3771	MA_Eighties	4/4	1	120			:
Bass	Chill	3772	MC_Eighties AF1	4/4	1	120			:
Bass	Jazz	3773	MA_AcousticJaz/1_N	4/4	4	204			Acoustic Bass
Bass	Jazz	3774	MA_AcousticJaz/2_N	4/4	4	204			:
Bass	Jazz	3775	MA_AcousticJaz/3_N	4/4	4	204			:
Bass	Jazz	3776	MA_AcousticJaz/4_N	4/4	4	204			:
Bass	Jazz	3777	MB_AcousticJaz/1_N	4/4	4	204			:
Bass	Jazz	3778	MB_AcousticJaz/2_N	4/4	4	204			:
Bass	Jazz	3779	MB_AcousticJaz/3_N	4/4	4	204			:
Bass	Jazz	3780	MB_AcousticJaz/4_N	4/4	4	204			:
Bass	Jazz	3781	MC_AcousticJaz/1_N	4/4	4	204			:
Bass	Jazz	3782	MC_AcousticJaz/2_N	4/4	4	204			:
Bass	Jazz	3783	MC_AcousticJaz/3_N	4/4	4	204			:
Bass	Jazz	3784	MC_AcousticJaz/4_N	4/4	4	204			:
Bass	Jazz	3785	MD_AcousticJaz/1_N	4/4	4	204			:
Bass	Jazz	3786	MD_AcousticJaz/2_N	4/4	4	204			:
Bass	Jazz	3787	MD_AcousticJaz/3_N	4/4	4	204			:
Bass	Jazz	3788	MD_AcousticJaz/4_N	4/4	4	204			:
Bass	Jazz	3789	IA_AcousticJaz_N	4/4	4	204			:
Bass	Jazz	3790	FA_AcousticJaz_N	4/4	1	204			:
Bass	Jazz	3791	FB_AcousticJaz_N	4/4	1	204			:
Bass	Jazz	3792	FC_AcousticJaz_N	4/4	4	204			:
Bass	Jazz	3793	MA_AcousticBas1	4/4	4	132			:
Bass	Jazz	3794	MA_AcousticBas2_N	4/4	4	132			:
Bass	Jazz	3795	MA_AcousticBas3_N	4/4	4	132			:
Bass	Jazz	3796	MA_AcousticBas4_N	4/4	8	132			:
Bass	Jazz	3797	MA_AcousticBas5_N	4/4	4	132			:
Bass	Jazz	3798	MA_Walkin	4/4	3	103			:
Bass	Jazz	3799	MA_Slow Blues 2_C	4/4	4	72			Finger Bass
Bass	Jazz	3800	MB_Slow Blues 2_C	4/4	4	72			:
Bass	Jazz	3801	MC_Slow Blues 2_C	4/4	4	72			:
Bass	Jazz	3802	FA_Slow Blues 2_C	4/4	1	72			:
Bass	Jazz	3803	FB_Slow Blues 2_C	4/4	1	72			:
Bass	Jazz	3804	FC_Slow Blues 2_C	4/4	1	72			:
Bass	Jazz	3805	BA_Slow Blues 2_C	4/4	1	72			:
Bass	Jazz	3806	MA_Slow Blues 2_N	4/4	4	72			:
Bass	Jazz	3807	MB_Slow Blues 2_N	4/4	4	72			:
Bass	Jazz	3808	MC_Slow Blues 2_N	4/4	4	72			:
Bass	Jazz	3809	FA_Slow Blues 2_N	4/4	1	72			:
Bass	Jazz	3810	FB_Slow Blues 2_N	4/4	1	72			:
Bass	Jazz	3811	FC_Slow Blues 2	4/4	1	72			:
Bass	Jazz	3812	BA_Slow Blues 2	4/4	1	72			:
Bass	Latin	3813	MA_Salsa 2_N	4/4	4	123			Acoustic Bass
Bass	Latin	3814	MB_Salsa 2_N	4/4	4	123			:
Bass	Latin	3815	FA_Salsa 2_N	4/4	1	123			:
Bass	Latin	3816	FC_Salsa 2_N	4/4	2	123			:
Bass	Latin	3817	MA_Montuno_N	4/4	4	100			Finger Bass
Bass	Latin	3818	MC_Montuno/1_N	4/4	4	100			:
Bass	Latin	3819	MC_Montuno/2_N	4/4	4	100			:
Bass	Latin	3820	MD_Montuno/1_N	4/4	4	100			:
Bass	Latin	3821	MD_Montuno/2_N						

Main Category	Sub Category	ARP No.	ARP Name	Time Signature	Length	Original Tempo	Accent	Random SFX	Sound Type
Bass	Latin	3827	MA_Samba_N	4/4	2	120			:
Bass	Latin	3828	MC_Samba_N	4/4	4	120			:
Bass	Latin	3829	MD_Samba_N	4/4	4	120			:
Bass	Latin	3830	IA_Samba_N	4/4	2	120			:
Bass	Latin	3831	MA_FretlessBas1_N	4/4	4	124			Fretless Bass
Bass	Latin	3832	MA_FretlessBas2_N	4/4	4	124			:
Bass	Latin	3833	MA_FretlessBas3_N	4/4	4	124			:
Bass	Latin	3834	MA_FretlessBas4_N	4/4	4	124			:
Bass	Latin	3835	MA_FretlessBas5_N	4/4	4	124			:
Bass	Latin	3836	MA_Latin Rock	4/4	2	120			Finger Bass
Bass	Latin	3837	MB_Latin Rock	4/4	2	120			:
Bass	Latin	3838	MC_Latin Rock	4/4	2	120			:
Bass	Latin	3839	MD_Latin Rock	4/4	4	120			:
Bass	Latin	3840	IA_Latin Rock	4/4	2	120			:
Bass	Latin	3841	FA_Latin Rock_N	4/4	1	120			:
Bass	Latin	3842	FB_Latin Rock_N	4/4	1	120			:
Bass	Latin	3843	MA_Disco Latin_C	4/4	4	100			:
Bass	Latin	3844	MB_Disco Latin_C	4/4	4	100			:
Bass	Latin	3845	MC_Disco Latin_C	4/4	4	100			:
Bass	Latin	3846	FA_Disco Latin_C	4/4	1	100			:
Bass	Latin	3847	FB_Disco Latin_C	4/4	1	100			:
Bass	Latin	3848	FC_Disco Latin_C	4/4	1	100			:
Bass	Latin	3849	BA_Disco Latin_C	4/4	1	100			:
Bass	Latin	3850	MA_Latin House_N	4/4	4	138			:
Bass	Latin	3851	MC_Latin House_N	4/4	4	138			:
Bass	Latin	3852	FA_Latin House_N	4/4	4	138			Synth Bass
Bass	World	3853	MA_Jumbo Reggae_C	4/4	4	100			:
Bass	World	3854	MB_Jumbo Reggae_C	4/4	4	100			:
Bass	World	3855	MC_Jumbo Reggae_C	4/4	4	100			:
Bass	World	3856	FA_Jumbo Reggae_C	4/4	1	100			:
Bass	World	3857	FB_Jumbo Reggae_C	4/4	1	100			:
Bass	World	3858	FC_Jumbo Reggae_C	4/4	1	100			:
Bass	World	3859	BA_Jumbo Reggae_C	4/4	1	100			:
Bass	World	3860	EA_Jumbo Reggae_C	4/4	3	100			:
Bass	World	3861	EB_Jumbo Reggae_C	4/4	3	100			:
Bass	World	3862	MA_Reggae 1	4/4	4	102			Finger Bass
Bass	World	3863	MB_Reggae 1	4/4	4	102			:
Bass	World	3864	MC_Reggae 1	4/4	4	80			:
Bass	World	3865	MD_Reggae 1	4/4	4	90			:
Bass	World	3866	IA_Reggae 1	4/4	4	102			:
Bass	World	3867	FA_Reggae 1	4/4	1	96			:
Bass	World	3868	FB_Reggae 1	4/4	1	90			:
Bass	World	3869	FC_Reggae 1	4/4	4	96			:
Bass	World	3870	MA_Reggae 2_N	4/4	2	92			:
Bass	World	3871	MB_Reggae 2_N	4/4	2	92			:
Bass	World	3872	MC_Reggae 2_N	4/4	2	92			:
Bass	World	3873	MD_Reggae 2_N	4/4	2	92			:
Bass	World	3874	IA_Reggae 2	4/4	2	92			:
Bass	World	3875	FA_Reggae 2_N	4/4	1	92			:
Bass	World	3876	FB_Reggae 2_N	4/4	1	92			:
Bass	World	3877	MA_Spanish Pop_N	4/4	1	120			:
Bass	World	3878	MB_Spanish Pop_N	4/4	2	120			:
Bass	World	3879	MC_Spanish Pop_N	4/4	1	120			:
Bass	World	3880	MD_Spanish Pop_N	4/4	1	120			:
Bass	World	3881	FA_Spanish Pop_N	4/4	1	120			:
Bass	World	3882	FC_Spanish Pop_N	4/4	2	120			:
Bass	World	3883	MA_Turkish Pop_C	4/4	4	101			Synth Bass
Bass	World	3884	MB_Turkish Pop_C	4/4	4	101			:
Bass	World	3885	MC_Turkish Pop_C	4/4	4	101			:
Bass	World	3886	MD_Turkish Pop_C	4/4	4	101			:
Bass	World	3887	MA_Turkish Pop_N	4/4	4	101			:
Bass	World	3888	MB_Turkish Pop_N	4/4	4	101			:
Bass	World	3889	MC_Turkish Pop_N	4/4	4	101			:
Bass	World	3890	MD_Turkish Pop_N	4/4	4	101			:
Bass	World	3891	MA_TurkishDance_C	4/4	4	130			:
Bass	World	3892	MB_TurkishDance_C	4/4	4	130			:
Bass	World	3893	MC_TurkishDance_C	4/4	4	130			:
Bass	World	3894	MD_TurkishDance_C	4/4	4	130			:
Bass	World	3895	MA_TurkishDance_N	4/4	4	130			:
Bass	World	3896	MB_TurkishDance	4/4	4	130			:
Bass	World	3897	MC_TurkishDance	4/4	4	130			:
Bass	World	3898	MD_TurkishDance_N	4/4	4	130			:
Bass	World	3899	MA_Turkish_N	4/4	2	105			Finger Bass
Bass	World	3900	MB_Turkish_N	4/4	2	105			:
Bass	World	3901	MC_Turkish_N	9/8	2	125			:
Bass	World	3902	MD_Turkish_N	9/8	2	125			:
Bass	World	3903	ME_Turkish_N	4/4	2	105			:
Bass	World	3904	MF_Turkish_N	4/4	2	105			:
Bass	World	3905	IA_Turkish_N	4/4	2	86			:
Bass	World	3906	MA_TurkishEuro1_C	4/4	4	112			Synth Bass
Bass	World	3907	MB_TurkishEuro1_C	4/4	4	112			:
Bass	World	3908	MC_TurkishEuro1_C	4/4	4	112			:
Bass	World	3909	FA_TurkishEuro1_C	4/4	1	112			:
Bass	World	3910	FB_TurkishEuro1_C	4/4	1	112			:
Bass	World	3911	FC_TurkishEuro1_C	4/4	1	112			:
Bass	World	3912	BA_TurkishEuro1_C	4/4	1	112			:
Bass	World	3913	EA_TurkishEuro1_C	4/4	3	112			:

Main Category	Sub Category	ARP No.	ARP Name	Time Signature	Length	Original Tempo	Accent	Random SFX	Sound Type
Bass	World	3914	MA_TurkishEuro2_C	4/4	4	120			:
Bass	World	3915	MB_TurkishEuro2_C	4/4	4	120			:
Bass	World	3916	MC_TurkishEuro2_C	4/4	4	120			:
Bass	World	3917	FA_TurkishEuro2_C	4/4	1	120			:
Bass	World	3918	FB_TurkishEuro2_C	4/4	1	120			:
Bass	World	3919	FC_TurkishEuro2_C	4/4	1	120			:
Bass	World	3920	BA_TurkishEuro2_C	4/4	1	120			:
Bass	World	3921	EA_TurkishEuro2_C	4/4	3	120			:
Bass	Rock	3922	[Mg]MA_StandrdRk_C	4/4	4	131		●	Mega Finger+Slap
Bass	Rock	3923	[Mg]MB_StandrdRk_C	4/4	4	131		●	:
Bass	Rock	3924	[Mg]MC_StandrdRk_C	4/4	4	131		●	:
Bass	Rock	3925	[Mg]FA_StandrdRk_C	4/4	1	131		●	:
Bass	Rock	3926	[Mg]FB_StandrdRk_C	4/4	1	131		●	:
Bass	Rock	3927	[Mg]FC_StandrdRk_C	4/4	1	131		●	:
Bass	Rock	3928	[Mg]BA_StandrdRk_C	4/4	1	131		●	:
Bass	Rock	3929	[Mg]EA_StandrdRk_C	4/4	4	131		●	:
Bass	Rock	3930	[Mg]EB_StandrdRk_C	4/4	6	131		●	:
Bass	Rock	3931	[Mg]MA_PowerRock_C	4/4	4	120		●	Mega Pick Open Mute
Bass	Rock	3932	[Mg]MB_PowerRock_C	4/4	4	120		●	:
Bass	Rock	3933	[Mg]MC_PowerRock_C	4/4	4	120		●	:
Bass	Rock	3934	[Mg]FA_PowerRock_C	4/4	1	120		●	:
Bass	Rock	3935	[Mg]FB_PowerRock_C	4/4	1	120		●	:
Bass	Rock	3936	[Mg]FC_PowerRock_C	4/4	1	120		●	:
Bass	Rock	3937	[Mg]BA_PowerRock_C	4/4	1	120		●	:
Bass	Rock	3938	[Mg]EA_PowerRock_C	4/4	4	120		●	:
Bass	Rock	3939	[Mg]EB_PowerRock_C	4/4	7	120		●	:
Bass	Rock	3940	[Mg]MA_CntmpRock_C	4/4	4	126		●	:
Bass	Rock	3941	[Mg]MB_CntmpRock_C	4/4	4	126		●	:
Bass	Rock	3942	[Mg]MC_CntmpRock_C	4/4	4	126		●	:
Bass	Rock	3943	[Mg]FA_CntmpRock_C	4/4	1	126		●	:
Bass	Rock	3944	[Mg]FB_CntmpRock_C	4/4	1	126		●	:
Bass	Rock	3945	[Mg]FC_CntmpRock_C	4/4	1	126		●	:
Bass	Rock	3946	[Mg]BA_CntmpRock_C	4/4	1	126		●	:
Bass	Rock	3947	[Mg]EA_CntmpRock_C	4/4	4	126		●	:
Bass	Rock	3948	[Mg]EB_CntmpRock_C	4/4	4	126		●	:
Bass	Rock	3949	[Mg]MA_HardRock_C	4/4	4	120		●	Mega Finger+Slap
Bass	Rock	3950	[Mg]MB_HardRock_C	4/4	4	120		●	:
Bass	Rock	3951	[Mg]MC_HardRock_C	4/4	4	120		●	:
Bass	Rock	3952	[Mg]FA_HardRock_C	4/4	1	120		●	:
Bass	Rock	3953	[Mg]FB_HardRock_C	4/4	1	120		●	:
Bass	Rock	3954	[Mg]FC_HardRock_C	4/4	1	120		●	:
Bass	Rock	3955	[Mg]BA_HardRock_C	4/4	1	120		●	:
Bass	Rock	3956	[Mg]EA_HardRock_C	4/4	3	120		●	:
Bass	Rock	3957	[Mg]EB_HardRock_C	4/4	6	120		●	:
Bass	Rock	3958	[Mg]MA_BluesRck_C	4/4	4	120		●	:
Bass	Rock	3959	[Mg]MB_BluesRck_C	4/4	4	120		●	:
Bass	Rock	3960	[Mg]MC_BluesRck_C	4/4	4	120		●	:
Bass	Rock	3961	[Mg]FA_BluesRck_C	4/4	1	120		●	:
Bass	Rock	3962	[Mg]FB_BluesRck_C	4/4	1	120		●	:
Bass	Rock	3963	[Mg]FC_BluesRck_C	4/4	1	120		●	:
Bass	Rock	3964	[Mg]BA_BluesRck_C	4/4	1	120		●	:
Bass	Rock	3965	[Mg]EA_BluesRck_C	4/4	3	120		●	:
Bass	Rock	3966	[Mg]EB_BluesRck_C	4/4	5	120		●	:
Bass	Rock	3967	[Mg]MA_RkShuffle_C	4/4	4	121		●	Mega Pick Open Mute
Bass	Rock	3968	[Mg]MB_RkShuffle_C	4/4	4	121		●	:
Bass	Rock	3969	[Mg]MC_RkShuffle_C	4/4	4	121		●	:
Bass	Rock	3970	[Mg]FA_RkShuffle_C	4/4	1	121		●	:
Bass	Rock	3971	[Mg]FB_RkShuffle_C	4/4	1	121		●	:
Bass	Rock	3972	[Mg]FC_RkShuffle_C	4/4	1	121		●	:
Bass	Rock	3973	[Mg]BA_RkShuffle_C	4/4	1	121		●	:
Bass	Rock	3974	[Mg]EA_RkShuffle_C	4/4	6	121		●	:
Bass	Rock	3975	[Mg]MA_Rock&Roll_C	4/4	4	172		●	:
Bass	Rock	3976	[Mg]MB_Rock&Roll_C	4/4	4	172		●	:
Bass	Rock	3977	[Mg]MC_Rock&Roll_C	4/4	4	172		●	:
Bass	Rock	3978	[Mg]FA_Rock&Roll_C	4/4	1	172		●	:
Bass	Rock	3979	[Mg]FB_Rock&Roll_C	4/4	1	172		●	:
Bass	Rock	3980	[Mg]FC_Rock&Roll_C	4/4	1	172		●	:
Bass	Rock	3981	[Mg]BA_Rock&Roll_C	4/4	1	172		●	:
Bass	Rock	3982	[Mg]EA_Rock&Roll_C	4/4	5	172		●	:
Bass	Rock	3983	[Mg]EB_Rock&Roll_C	4/4	6	172		●	:
Bass	Rock	3984	[Mg]MC_MapleCsBs_C	4/4	4	150		●	Mega Finger+Slap
Bass	Rock	3985	[Mg]MD_MapleCsBs_C	4/4	4	150		●	:
Bass	Rock	3986	[Mg]EA_MapleCsBs_C	4/4	7	150		●	:
Bass	Pop Rock	3987	[Mg]MA_8Beat Med_C	4/4	4	105		●	Mega Finger+Harmonic
Bass	Pop Rock	3988	[Mg]MB_8Beat Med_C	4/4	4	105		●	:
Bass	Pop Rock	3989	[Mg]MC_8Beat Med_C	4/4	4	105		●	:
Bass	Pop Rock	3990	[Mg]MA_8Beat Med_C	4/4	4	105		●	:
Bass	Pop Rock	3991	[Mg]FA_8Beat Med_C	4/4	1				

Main Category	Sub Category	ARP No.	ARP Name	Time Signature	Length	Original Tempo	Accent	Random SFX	Sound Type
Bass	Pop Rock	4001	[Mg]FB_8Bt Fast_C	4/4	1	140		•	:
Bass	Pop Rock	4002	[Mg]FC_8Bt Fast_C	4/4	1	140		•	:
Bass	Pop Rock	4003	[Mg]FD_8Bt Fast_C	4/4	1	140		•	:
Bass	Pop Rock	4004	[Mg]EA_8Bt Fast_C	4/4	5	140		•	:
Bass	Pop Rock	4005	[Mg]MA_16Bt Med_C	4/4	4	96		•	Mega Finger+Harmonic
Bass	Pop Rock	4006	[Mg]MB_16Bt Med_C	4/4	4	96		•	:
Bass	Pop Rock	4007	[Mg]MC_16Bt Med_C	4/4	4	96		•	:
Bass	Pop Rock	4008	[Mg]MD_16Bt Med_C	4/4	4	96		•	:
Bass	Pop Rock	4009	[Mg]FA_16Bt Med_C	4/4	1	96		•	:
Bass	Pop Rock	4010	[Mg]FB_16Bt Med_C	4/4	1	96		•	:
Bass	Pop Rock	4011	[Mg]FC_16Bt Med_C	4/4	1	96		•	:
Bass	Pop Rock	4012	[Mg]FD_16Bt Med_C	4/4	1	96		•	:
Bass	Pop Rock	4013	[Mg]EA_16Bt Med_C	4/4	4	96		•	:
Bass	Pop Rock	4014	[Mg]MA_GtPopMed_C	4/4	4	98		•	:
Bass	Pop Rock	4015	[Mg]MB_GtPopMed_C	4/4	4	98		•	:
Bass	Pop Rock	4016	[Mg]MC_GtPopMed_C	4/4	4	98		•	:
Bass	Pop Rock	4017	[Mg]MD_GtPopMed_C	4/4	4	98		•	:
Bass	Pop Rock	4018	[Mg]FA_GtPopMed_C	4/4	1	98		•	:
Bass	Pop Rock	4019	[Mg]FB_GtPopMed_C	4/4	1	98		•	:
Bass	Pop Rock	4020	[Mg]FC_GtPopMed_C	4/4	1	98		•	:
Bass	Pop Rock	4021	[Mg]FD_GtPopMed_C	4/4	1	98		•	:
Bass	Pop Rock	4022	[Mg]EA_GtPopMed_C	4/4	3	98		•	:
Bass	Pop Rock	4023	[Mg]MA_PopShft1_C	4/4	4	180		•	:
Bass	Pop Rock	4024	[Mg]MB_PopShft1_C	4/4	4	180		•	:
Bass	Pop Rock	4025	[Mg]MC_PopShft1_C	4/4	4	180		•	:
Bass	Pop Rock	4026	[Mg]MD_PopShft1_C	4/4	4	180		•	:
Bass	Pop Rock	4027	[Mg]FA_PopShft1_C	4/4	1	180		•	:
Bass	Pop Rock	4028	[Mg]FB_PopShft1_C	4/4	1	180		•	:
Bass	Pop Rock	4029	[Mg]FC_PopShft1_C	4/4	1	180		•	:
Bass	Pop Rock	4030	[Mg]FD_PopShft1_C	4/4	1	180		•	:
Bass	Pop Rock	4031	[Mg]EA_PopShft1_C	4/4	5	180		•	:
Bass	Pop Rock	4032	[Mg]MA_SwMOR Pp_C	4/4	4	94		•	:
Bass	Pop Rock	4033	[Mg]MB_SwMOR Pp_C	4/4	4	94		•	:
Bass	Pop Rock	4034	[Mg]MC_SwMOR Pp_C	4/4	4	94		•	:
Bass	Pop Rock	4035	[Mg]MD_SwMOR Pp_C	4/4	4	94		•	:
Bass	Pop Rock	4036	[Mg]FA_SwMOR Pp_C	4/4	1	94		•	:
Bass	Pop Rock	4037	[Mg]FB_SwMOR Pp_C	4/4	1	94		•	:
Bass	Pop Rock	4038	[Mg]FC_SwMOR Pp_C	4/4	1	94		•	:
Bass	Pop Rock	4039	[Mg]FD_SwMOR Pp_C	4/4	1	94		•	:
Bass	Pop Rock	4040	[Mg]EA_SwMOR Pp_C	4/4	3	94		•	:
Bass	Pop Rock	4041	[Mg]MA_12/8 Pop_C	6/4	4	90		•	:
Bass	Pop Rock	4042	[Mg]MB_12/8 Pop_C	6/4	4	90		•	:
Bass	Pop Rock	4043	[Mg]MC_12/8 Pop_C	6/4	4	90		•	:
Bass	Pop Rock	4044	[Mg]MD_12/8 Pop_C	6/4	4	90		•	:
Bass	Pop Rock	4045	[Mg]FA_12/8 Pop_C	6/4	1	90		•	:
Bass	Pop Rock	4046	[Mg]FB_12/8 Pop_C	6/4	1	90		•	:
Bass	Pop Rock	4047	[Mg]FC_12/8 Pop_C	6/4	1	90		•	:
Bass	Pop Rock	4048	[Mg]FD_12/8 Pop_C	6/4	1	90		•	:
Bass	Pop Rock	4049	[Mg]EA_12/8 Pop_C	6/4	4	90		•	:
Bass	Pop Rock	4050	[Mg]MA_Cntry8Bt_C	4/4	4	82		•	:
Bass	Pop Rock	4051	[Mg]MB_Cntry8Bt_C	4/4	4	82		•	:
Bass	Pop Rock	4052	[Mg]MC_Cntry8Bt_C	4/4	4	82		•	:
Bass	Pop Rock	4053	[Mg]MD_Cntry8Bt_C	4/4	4	82		•	:
Bass	Pop Rock	4054	[Mg]FA_Cntry8Bt_C	4/4	1	82		•	:
Bass	Pop Rock	4055	[Mg]FB_Cntry8Bt_C	4/4	1	82		•	:
Bass	Pop Rock	4056	[Mg]FC_Cntry8Bt_C	4/4	1	82		•	:
Bass	Pop Rock	4057	[Mg]FD_Cntry8Bt_C	4/4	1	82		•	:
Bass	Pop Rock	4058	[Mg]EA_Cntry8Bt_C	4/4	3	82		•	:
Bass	Pop Rock	4059	[Mg]MA_CntrySwg_C	4/4	4	182		•	Mega Acoustic Bass
Bass	Pop Rock	4060	[Mg]MB_CntrySwg_C	4/4	4	182		•	:
Bass	Pop Rock	4061	[Mg]MC_CntrySwg_C	4/4	4	182		•	:
Bass	Pop Rock	4062	[Mg]MD_CntrySwg_C	4/4	4	182		•	:
Bass	Pop Rock	4063	[Mg]FA_CntrySwg_C	4/4	1	182		•	:
Bass	Pop Rock	4064	[Mg]FB_CntrySwg_C	4/4	1	182		•	:
Bass	Pop Rock	4065	[Mg]FC_CntrySwg_C	4/4	1	182		•	:
Bass	Pop Rock	4066	[Mg]FD_CntrySwg_C	4/4	1	182		•	:
Bass	Pop Rock	4067	[Mg]EA_CntrySwg_C	4/4	5	182		•	:
Bass	Pop Rock	4068	[Mg]MA_CntryWlz_C	3/4	4	144		•	Mega Pick Open Mute
Bass	Pop Rock	4069	[Mg]MB_CntryWlz_C	3/4	4	144		•	:
Bass	Pop Rock	4070	[Mg]MC_CntryWlz_C	3/4	4	144		•	:
Bass	Pop Rock	4071	[Mg]MD_CntryWlz_C	3/4	4	144		•	:
Bass	Pop Rock	4072	[Mg]FA_CntryWlz_C	3/4	1	144		•	:
Bass	Pop Rock	4073	[Mg]FB_CntryWlz_C	3/4	1	144		•	:
Bass	Pop Rock	4074	[Mg]FC_CntryWlz_C	3/4	1	144		•	:
Bass	Pop Rock	4075	[Mg]FD_CntryWlz_C	3/4	1	144		•	:
Bass	Pop Rock	4076	[Mg]EA_CntryWlz_C	3/4	5	144		•	:
Bass	Pop Rock	4077	[Mg]MA_Gtr Pop1_C	4/4	4	100		•	Mega Finger+Slap
Bass	Pop Rock	4078	[Mg]MB_Gtr Pop1_C	4/4	4	100		•	:
Bass	Pop Rock	4079	[Mg]MC_Gtr Pop1_C	4/4	4	100		•	:
Bass	Pop Rock	4080	[Mg]FA_Gtr Pop1_C	4/4	1	100		•	:
Bass	Pop Rock	4081	[Mg]FB_Gtr Pop1_C	4/4	1	100		•	:
Bass	Pop Rock	4082	[Mg]FC_Gtr Pop1_C	4/4	1	100		•	:
Bass	Pop Rock	4083	[Mg]BA_Gtr Pop1_C	4/4	1	100		•	:
Bass	Pop Rock	4084	[Mg]EA_Gtr Pop1_C	4/4	3	100		•	:
Bass	Pop Rock	4085	[Mg]EB_Gtr Pop1_C	4/4	3	100		•	:
Bass	Pop Rock	4086	[Mg]MA_AcoustPp_C	4/4	4	110		•	:
Bass	Pop Rock	4087	[Mg]MB_AcoustPp_C	4/4	4	110		•	:

Main Category	Sub Category	ARP No.	ARP Name	Time Signature	Length	Original Tempo	Accent	Random SFX	Sound Type
Bass	Pop Rock	4088	[Mg]MC_AcoustPp_C	4/4	4	110		•	:
Bass	Pop Rock	4089	[Mg]FA_AcoustPp_C	4/4	1	110		•	:
Bass	Pop Rock	4090	[Mg]FB_AcoustPp_C	4/4	1	110		•	:
Bass	Pop Rock	4091	[Mg]FC_AcoustPp_C	4/4	1	110		•	:
Bass	Pop Rock	4092	[Mg]MA_WorshpSlw_C	4/4	4	75		•	:
Bass	Pop Rock	4093	[Mg]MB_WorshpSlw_C	4/4	4	75		•	:
Bass	Pop Rock	4094	[Mg]MC_WorshpSlw_C	4/4	4	75		•	:
Bass	Pop Rock	4095	[Mg]FA_WorshpSlw_C	4/4	1	75		•	:
Bass	Pop Rock	4096	[Mg]FB_WorshpSlw_C	4/4	1	75		•	:
Bass	Pop Rock	4097	[Mg]FC_WorshpSlw_C	4/4	1	75		•	:
Bass	Pop Rock	4098	[Mg]BA_WorshpSlw_C	4/4	1	75		•	:
Bass	Pop Rock	4099	[Mg]EA_WorshpSlw_C	4/4	4	75		•	:
Bass	Pop Rock	4100	[Mg]EB_WorshpSlw_C	4/4	4	75		•	:
Bass	Pop Rock	4101	[Mg]MA_WorshpMed_C	4/4	8	140		•	Mega Acoustic Bass
Bass	Pop Rock	4102	[Mg]MB_WorshpMed_C	4/4	4	140		•	:
Bass	Pop Rock	4103	[Mg]MC_WorshpMed_C	4/4	4	140		•	:
Bass	Pop Rock	4104	[Mg]FA_WorshpMed_C	4/4	1	140		•	:
Bass	Pop Rock	4105	[Mg]FB_WorshpMed_C	4/4	1	140		•	:
Bass	Pop Rock	4106	[Mg]FC_WorshpMed_C	4/4	1	140		•	:
Bass	Pop Rock	4107	[Mg]BA_WorshpMed_C	4/4	1	140		•	:
Bass	Pop Rock	4108	[Mg]EA_WorshpMed_C	4/4	4	140		•	:
Bass	Pop Rock	4109	[Mg]EB_WorshpMed_C	4/4	4	140		•	:
Bass	Pop Rock	4110	[Mg]MA_WorshpFst_C	4/4	8	114		•	Mega Finger+Slap
Bass	Pop Rock	4111	[Mg]MB_WorshpFst_C	4/4	4	114		•	:
Bass	Pop Rock	4112	[Mg]MC_WorshpFst_C	4/4	4	114		•	:
Bass	Pop Rock	4113	[Mg]FA_WorshpFst_C	4/4	1	114		•	:
Bass	Pop Rock	4114	[Mg]FB_WorshpFst_C	4/4	1	114		•	:
Bass	Pop Rock	4115	[Mg]FC_WorshpFst_C	4/4	1	114		•	:
Bass	Pop Rock	4116	[Mg]BA_WorshpFst_C	4/4	1	114		•	:
Bass	Pop Rock	4117	[Mg]EA_WorshpFst_C	4/4	4	114		•	:
Bass	Pop Rock	4118	[Mg]EB_WorshpFst_C	4/4	2	114		•	:
Bass	Pop Rock	4119	[Mg]MA_New Cntry_C	4/4	2	118		•	:
Bass	Pop Rock	4120	[Mg]MB_New Cntry_C	4/4	4	118		•	:
Bass	Pop Rock	4121	[Mg]MC_New Cntry_C	4/4	2	118		•	:
Bass	Pop Rock	4122	[Mg]FA_New Cntry_C	4/4	1	118		•	:
Bass	Pop Rock	4123	[Mg]FB_New Cntry_C	4/4	1	118		•	:
Bass	Pop Rock	4124	[Mg]FC_New Cntry_C	4/4	1	118		•	:
Bass	Pop Rock	4125	[Mg]BA_New Cntry_C	4/4	1	118		•	:
Bass	Pop Rock	4126	[Mg]EA_New Cntry_C	4/4	4	118		•	:
Bass	Pop Rock	4127	[Mg]EB_New Cntry_C	4/4	4	118		•	:
Bass	Pop Rock	4128	[Mg]MA_VintgGtPp_C	4/4	4	148		•	:
Bass	Pop Rock	4129	[Mg]MB_VintgGtPp_C	4/4	4	148		•	:
Bass	Pop Rock	4130	[Mg]MC_VintgGtPp_C	4/4	4	148		•	:
Bass	Pop Rock	4131	[Mg]FA_VintgGtPp_C	4/4	1	148		•	:
Bass	Pop Rock	4132	[Mg]FB_VintgGtPp_C	4/4	1	148		•	:
Bass	Pop Rock	4133	[Mg]FC_VintgGtPp_C	4/4	1	148		•	:
Bass	Pop Rock	4134	[Mg]BA_VintgGtPp_C	4/4	1	148		•	:
Bass	Pop Rock	4135	[Mg]EA_VintgGtPp_C	4/4	4	148		•	:
Bass	Pop Rock	4136	[Mg]EB_VintgGtPp_C	4/4	4	148		•	:
Bass	Pop Rock	4137	[Mg]MA_WestCstPp_C	4/4	4	100		•	:
Bass	Pop Rock	4138	[Mg]MB_WestCstPp_C	4/4	4	100		•	:
Bass	Pop Rock	4139	[Mg]MC_WestCstPp_C	4/4	4	100		•	:
Bass	Pop Rock	4140	[Mg]FA_WestCstPp_C	4/4	1	100		•	:
Bass	Pop Rock	4141	[Mg]FB_WestCstPp_C	4/4	1	100		•	:
Bass	Pop Rock	4142	[Mg]FC_WestCstPp_C	4/4	1	100		•	:
Bass	Pop Rock	4143	[Mg]BA_WestCstPp_C	4/4	1	100		•	:
Bass	Pop Rock	4144	[Mg]EA_WestCstPp_C	4/4	4	100		•	:
Bass	Pop Rock	4145	[Mg]EB_WestCstPp_C	4/4	4	100		•	:
Bass	Pop Rock	4146	[Mg]MA_Brit Pop_C	4/4	2	86		•	:
Bass	Pop Rock	4147	[Mg]MB_Brit Pop_C	4/4	2	86		•	:
Bass	Pop Rock	4148	[Mg]MC_Brit Pop_C	4/4	2	86		•	:
Bass	Pop Rock	4149	[Mg]FA_Brit Pop_C	4/4	1	86		•	:
Bass	Pop Rock	4150	[Mg]FB_Brit Pop_C	4/4	1	86		•	:
Bass	Pop Rock	4151	[Mg]FC_Brit Pop_C	4/4	1	86		•	:
Bass	Pop Rock	4152	[Mg]BA_Brit Pop_C	4/4	1	86		•	:
Bass	Pop Rock	4153	[Mg]EA_Brit Pop_C	4/4	4	86		•	:
Bass	Pop Rock	4154	[Mg]EB_Brit Pop_C	4/4	4	86		•	:
Bass	Pop Rock	4155	[Mg]MA_BritPpSwg_C	4/4	2				

Arpeggio Type List

Main Category	Sub Category	ARP No.	ARP Name	Time Signature	Length	Original Tempo	Accent	Random SFX	Sound Type
Bass	Pop Rock	4175	[Mg]MC_BritRkPop_C	4/4	4	123		●	:
Bass	Pop Rock	4176	[Mg]FA_BritRkPop_C	4/4	1	123		●	:
Bass	Pop Rock	4177	[Mg]FB_BritRkPop_C	4/4	1	123		●	:
Bass	Pop Rock	4178	[Mg]FC_BritRkPop_C	4/4	1	123		●	:
Bass	Pop Rock	4179	[Mg]BA_BritRkPop_C	4/4	1	123		●	:
Bass	Pop Rock	4180	[Mg]EA_BritRkPop_C	4/4	6	123		●	:
Bass	Pop Rock	4181	[Mg]MA_80sPopRk_C	4/4	4	111		●	Mega Pick Open Mute
Bass	Pop Rock	4182	[Mg]MB_80sPopRk_C	4/4	4	111		●	:
Bass	Pop Rock	4183	[Mg]MC_80sPopRk_C	4/4	4	111		●	:
Bass	Pop Rock	4184	[Mg]FA_80sPopRk_C	4/4	1	111		●	:
Bass	Pop Rock	4185	[Mg]FB_80sPopRk_C	4/4	1	111		●	:
Bass	Pop Rock	4186	[Mg]FC_80sPopRk_C	4/4	1	111		●	:
Bass	Pop Rock	4187	[Mg]BA_80sPopRk_C	4/4	1	111		●	:
Bass	Pop Rock	4188	[Mg]EA_80sPopRk_C	4/4	7	111		●	:
Bass	Pop Rock	4189	[Mg]MA_80sSynthRk_C	4/4	4	96		●	Mega Finger+Harmonic
Bass	Pop Rock	4190	[Mg]MB_80sSynthRk_C	4/4	4	96		●	:
Bass	Pop Rock	4191	[Mg]MC_80sSynthRk_C	4/4	8	96		●	:
Bass	Pop Rock	4192	[Mg]FA_80sSynthRk_C	4/4	1	96		●	:
Bass	Pop Rock	4193	[Mg]FB_80sSynthRk_C	4/4	1	96		●	:
Bass	Pop Rock	4194	[Mg]FC_80sSynthRk_C	4/4	1	96		●	:
Bass	Pop Rock	4195	[Mg]BA_80sSynthRk_C	4/4	1	96		●	:
Bass	Pop Rock	4196	[Mg]EA_80sSynthRk_C	4/4	3	96		●	:
Bass	Pop Rock	4197	[Mg]MA_60VintgPp_C	4/4	4	132		●	Mega Acoustic Bass
Bass	Pop Rock	4198	[Mg]MB_60VintgPp_C	4/4	4	132		●	:
Bass	Pop Rock	4199	[Mg]MC_60VintgPp_C	4/4	4	132		●	:
Bass	Pop Rock	4200	[Mg]FA_60VintgPp_C	4/4	1	132		●	:
Bass	Pop Rock	4201	[Mg]FB_60VintgPp_C	4/4	1	132		●	:
Bass	Pop Rock	4202	[Mg]FC_60VintgPp_C	4/4	1	132		●	:
Bass	Pop Rock	4203	[Mg]BA_60VintgPp_C	4/4	1	132		●	:
Bass	Pop Rock	4204	[Mg]EA_60VintgPp_C	4/4	2	132		●	:
Bass	Pop Rock	4205	[Mg]MA_60ChartSw_C	4/4	4	123		●	Mega Finger+Harmonic
Bass	Pop Rock	4206	[Mg]MB_60ChartSw_C	4/4	4	123		●	:
Bass	Pop Rock	4207	[Mg]MC_60ChartSw_C	4/4	4	123		●	:
Bass	Pop Rock	4208	[Mg]FA_60ChartSw_C	4/4	1	123		●	:
Bass	Pop Rock	4209	[Mg]FB_60ChartSw_C	4/4	1	123		●	:
Bass	Pop Rock	4210	[Mg]FC_60ChartSw_C	4/4	1	123		●	:
Bass	Pop Rock	4211	[Mg]BA_60ChartSw_C	4/4	1	123		●	:
Bass	Pop Rock	4212	[Mg]EA_60ChartSw_C	4/4	4	123		●	:
Bass	Pop Rock	4213	[Mg]MA_16Bt Pop1_C	4/4	4	103		●	Mega Slap Bass
Bass	Pop Rock	4214	[Mg]MB_16Bt Pop1_C	4/4	4	103		●	:
Bass	Pop Rock	4215	[Mg]MC_16Bt Pop1_C	4/4	4	103		●	:
Bass	Pop Rock	4216	[Mg]FA_16Bt Pop1_C	4/4	1	103		●	:
Bass	Pop Rock	4217	[Mg]FB_16Bt Pop1_C	4/4	1	103		●	:
Bass	Pop Rock	4218	[Mg]FC_16Bt Pop1_C	4/4	1	103		●	:
Bass	Pop Rock	4219	[Mg]BA_16Bt Pop1_C	4/4	1	103		●	:
Bass	Pop Rock	4220	[Mg]EA_16Bt Pop1_N	4/4	4	103		●	:
Bass	Pop Rock	4221	[Mg]MA_16Bt Pop1_N	4/4	4	103		●	:
Bass	Pop Rock	4222	[Mg]MB_16Bt Pop1_N	4/4	4	103		●	:
Bass	Pop Rock	4223	[Mg]MC_16Bt Pop1_N	4/4	1	103		●	:
Bass	Pop Rock	4224	[Mg]FA_16Bt Pop1_N	4/4	1	103		●	:
Bass	Pop Rock	4225	[Mg]FB_16Bt Pop1_N	4/4	1	103		●	:
Bass	Pop Rock	4226	[Mg]FC_16Bt Pop1_N	4/4	1	103		●	:
Bass	Ballad	4227	[Mg]BA_8Bt Bld1_C	4/4	4	103		●	Mega Finger+Harmonic
Bass	Ballad	4228	[Mg]MB_8Bt Bld1_C	4/4	4	103		●	:
Bass	Ballad	4229	[Mg]MC_8Bt Bld1_C	4/4	4	103		●	:
Bass	Ballad	4230	[Mg]FA_8Bt Bld1_C	4/4	4	103		●	:
Bass	Ballad	4231	[Mg]FB_8Bt Bld1_C	4/4	1	103		●	:
Bass	Ballad	4232	[Mg]FC_8Bt Bld1_C	4/4	1	103		●	:
Bass	Ballad	4233	[Mg]BA_8Bt Bld1_C	4/4	1	103		●	:
Bass	Ballad	4234	[Mg]EA_8Bt Bld1_C	4/4	1	103		●	:
Bass	Ballad	4235	[Mg]MA_12/8 Bld1_C	4/4	4	59		●	:
Bass	Ballad	4236	[Mg]MB_12/8 Bld1_C	4/4	4	59		●	:
Bass	Ballad	4237	[Mg]MC_12/8 Bld1_C	4/4	4	59		●	:
Bass	Ballad	4238	[Mg]FA_12/8 Bld1_C	4/4	4	59		●	:
Bass	Ballad	4239	[Mg]FB_12/8 Bld1_C	4/4	1	59		●	:
Bass	Ballad	4240	[Mg]FC_12/8 Bld1_C	4/4	1	59		●	:
Bass	Ballad	4241	[Mg]BA_12/8 Bld1_C	4/4	1	59		●	:
Bass	Ballad	4242	[Mg]EA_12/8 Bld1_C	4/4	1	59		●	:
Bass	Ballad	4243	[Mg]MA_12/8 Bld1_C	4/4	1	59		●	:
Bass	Ballad	4244	[Mg]MB_12/8 Bld1_C	4/4	3	59		●	:
Bass	Ballad	4245	[Mg]MC_12/8 Bld1_C	4/4	4	60		●	:
Bass	Ballad	4246	[Mg]FA_12/8 Bld1_C	4/4	4	60		●	:
Bass	Ballad	4247	[Mg]FB_12/8 Bld1_C	4/4	4	60		●	:
Bass	Ballad	4248	[Mg]FC_12/8 Bld1_C	4/4	4	60		●	:
Bass	Ballad	4249	[Mg]BA_12/8 Bld1_C	4/4	1	60		●	:
Bass	Ballad	4250	[Mg]EA_12/8 Bld1_C	4/4	1	60		●	:
Bass	Ballad	4251	[Mg]MA_12/8 Bld1_C	4/4	1	60		●	:
Bass	Ballad	4252	[Mg]MB_12/8 Bld1_C	4/4	1	60		●	:
Bass	Ballad	4253	[Mg]MC_12/8 Bld1_C	4/4	3	60		●	:
Bass	Ballad	4254	[Mg]FA_CntryBld_C	4/4	4	75		●	Mega Acoustic Bass
Bass	Ballad	4255	[Mg]MB_CntryBld_C	4/4	4	75		●	:
Bass	Ballad	4256	[Mg]MC_CntryBld_C	4/4	4	75		●	:
Bass	Ballad	4257	[Mg]FA_CntryBld_C	4/4	4	75		●	:
Bass	Ballad	4258	[Mg]FB_CntryBld_C	4/4	1	75		●	:
Bass	Ballad	4259	[Mg]FC_CntryBld_C	4/4	1	75		●	:
Bass	Ballad	4260	[Mg]BA_CntryBld_C	4/4	1	75		●	:
Bass	Ballad	4261	[Mg]EA_CntryBld_C	4/4	1	75		●	:

Main Category	Sub Category	ARP No.	ARP Name	Time Signature	Length	Original Tempo	Accent	Random SFX	Sound Type
Bass	Ballad	4262	[Mg]EA_CntryBld_C	4/4	3	75		●	:
Bass	Ballad	4263	[Mg]MA_AnthRkBd_C	4/4	4	72		●	Mega Finger+Harmonic
Bass	Ballad	4264	[Mg]MB_AnthRkBd_C	4/4	4	72		●	:
Bass	Ballad	4265	[Mg]MC_AnthRkBd_C	4/4	4	72		●	:
Bass	Ballad	4266	[Mg]MD_AnthRkBd_C	4/4	4	72		●	:
Bass	Ballad	4267	[Mg]FA_AnthRkBd_C	4/4	1	72		●	:
Bass	Ballad	4268	[Mg]FB_AnthRkBd_C	4/4	1	72		●	:
Bass	Ballad	4269	[Mg]FC_AnthRkBd_C	4/4	1	72		●	:
Bass	Ballad	4270	[Mg]BA_AnthRkBd_C	4/4	1	72		●	:
Bass	Ballad	4271	[Mg]EA_AnthRkBd_C	4/4	3	72		●	:
Bass	Ballad	4272	[Mg]MA_ElectBld_C	4/4	4	84		●	Mega Acoustic Bass
Bass	Ballad	4273	[Mg]MB_ElectBld_C	4/4	4	84		●	:
Bass	Ballad	4274	[Mg]MC_ElectBld_C	4/4	4	84		●	:
Bass	Ballad	4275	[Mg]MD_ElectBld_C	4/4	4	84		●	:
Bass	Ballad	4276	[Mg]FA_ElectBld_C	4/4	1	84		●	:
Bass	Ballad	4277	[Mg]FB_ElectBld_C	4/4	1	84		●	:
Bass	Ballad	4278	[Mg]FC_ElectBld_C	4/4	1	84		●	:
Bass	Ballad	4279	[Mg]BA_ElectBld_C	4/4	1	84		●	:
Bass	Ballad	4280	[Mg]EA_ElectBld_C	4/4	4	84		●	:
Bass	Ballad	4281	[Mg]MA_GtBallad_C	4/4	8	94		●	Mega Finger+Slap
Bass	Ballad	4282	[Mg]MB_GtBallad_C	4/4	8	94		●	:
Bass	Ballad	4283	[Mg]MC_GtBallad_C	4/4	8	94		●	:
Bass	Ballad	4284	[Mg]FA_GtBallad_C	4/4	1	94		●	:
Bass	Ballad	4285	[Mg]FB_GtBallad_C	4/4	1	94		●	:
Bass	Ballad	4286	[Mg]FC_GtBallad_C	4/4	1	94		●	:
Bass	Ballad	4287	[Mg]BA_GtBallad_C	4/4	1	94		●	:
Bass	Ballad	4288	[Mg]EA_GtBallad_C	4/4	4	94		●	:
Bass	Ballad	4289	[Mg]MA_Unpluggd1_C	4/4	4	120		●	Mega Acoustic Bass
Bass	Ballad	4290	[Mg]MB_Unpluggd1_C	4/4	4	120		●	:
Bass	Ballad	4291	[Mg]MC_Unpluggd1_C	4/4	4	120		●	:
Bass	Ballad	4292	[Mg]FA_Unpluggd1_C	4/4	4	120		●	:
Bass	Ballad	4293	[Mg]FB_Unpluggd1_C	4/4	1	120		●	:
Bass	Ballad	4294	[Mg]FC_Unpluggd1_C	4/4	1	120		●	:
Bass	Ballad	4295	[Mg]BA_Unpluggd1_C	4/4	1	120		●	:
Bass	Ballad	4296	[Mg]EA_Unpluggd1_C	4/4	1	120		●	:
Bass	Ballad	4297	[Mg]MA_Unpluggd2_C	4/4	8	120		●	Mega Finger+Slap
Bass	Ballad	4298	[Mg]MB_Unpluggd2_C	4/4	8	120		●	:
Bass	Ballad	4299	[Mg]MC_Unpluggd2_C	4/4	8	120		●	:
Bass	Ballad	4300	[Mg]FA_Unpluggd2_C	4/4	1	120		●	:
Bass	Ballad	4301	[Mg]FB_Unpluggd2_C	4/4	1	120		●	:
Bass	Ballad	4302	[Mg]FC_Unpluggd2_C	4/4	1	120		●	:
Bass	Ballad	4303	[Mg]BA_Unpluggd2_C	4/4	1	120		●	:
Bass	Ballad	4304	[Mg]EA_Unpluggd2_C	4/4	5	120		●	:
Bass	Ballad	4305	[Mg]MA_8Bt Bld2_C	4/4	4	101		●	:
Bass	Ballad	4306	[Mg]MB_8Bt Bld2_C	4/4	4	101		●	:
Bass	Ballad	4307	[Mg]MC_8Bt Bld2_C	4/4	4	101		●	:
Bass	Ballad	4308	[Mg]FA_8Bt Bld2_C	4/4	1	101		●	:
Bass	Ballad	4309	[Mg]FB_8Bt Bld2_C	4/4	1	101		●	:
Bass	Ballad	4310	[Mg]FC_8Bt Bld2_C	4/4	1	101		●	:
Bass	Ballad	4311	[Mg]BA_8Bt Bld2_C	4/4	1	101		●	:
Bass	Ballad	4312	[Mg]EA_8Bt Bld2_C	4/4	1	101		●	:
Bass	Ballad	4313	[Mg]MA_EP Ballad_C	4/4	5	101		●	:
Bass	Ballad	4314	[Mg]MB_EP Ballad_C	4/4	5	101		●	:
Bass	Ballad	4315	[Mg]MC_EP Ballad_C	4/4	2	60		●	:
Bass	Ballad	4316	[Mg]FA_EP Ballad_C	4/4	2	60		●	:
Bass	Ballad	4317	[Mg]FB_EP Ballad_C	4/4	2	60		●	:
Bass	Ballad	4318	[Mg]FC_EP Ballad_C	4/4	1	60		●	:
Bass	Ballad	4319	[Mg]BA_EP Ballad_C	4/4	1	60		●	:
Bass	Ballad	4320	[Mg]EA_EP Ballad_C	4/4	1	60		●	:
Bass	Ballad	4321	[Mg]MA_EP Ballad_C	4/4	1	60		●	:
Bass	Ballad	4322	[Mg]MB_EP Ballad_C	4/4	4	60		●	:
Bass	Ballad	4323	[Mg]MC_EP Ballad_C	4/4	4	60		●	:
Bass	Ballad	4324	[Mg]FA_NuJazzyBs_C	4/4	4	61		●	:
Bass	Modern R&B	4325	[Mg]MA_NeoUKSoul_C	4/4	4	79		●	Mega Finger+Harmonic
Bass	Modern R&B	4326	[Mg]MB_NeoUKSoul_C	4/4	4	79		●	:
Bass	Modern R&B	4327	[Mg]MC_NeoUKSoul_C	4/4	4	79			

Main Category	Sub Category	ARP No.	ARP Name	Time Signature	Length	Original Tempo	Accent	Random SFX	Sound Type
Bass	Classic R&B	4349	[Mg]BA_SmldrDsc_C	4 / 4	1	120		●	:
Bass	Classic R&B	4350	[Mg]EA_SmldrDsc_C	4 / 4	3	120		●	:
Bass	Classic R&B	4351	[Mg]EB_SmldrDsc_C	4 / 4	3	120		●	:
Bass	Classic R&B	4352	[Mg]MA_Retro Dsc_C	4 / 4	4	108		●	:
Bass	Classic R&B	4353	[Mg]MC_Retro Dsc_C	4 / 4	4	108		●	:
Bass	Classic R&B	4354	[Mg]MC_Retro Dsc_C	4 / 4	4	108		●	:
Bass	Classic R&B	4355	[Mg]FA_Retro Dsc_C	4 / 4	1	108		●	:
Bass	Classic R&B	4356	[Mg]FB_Retro Dsc_C	4 / 4	1	108		●	:
Bass	Classic R&B	4357	[Mg]FC_Retro Dsc_C	4 / 4	1	108		●	:
Bass	Classic R&B	4358	[Mg]BA_Retro Dsc_C	4 / 4	1	108		●	:
Bass	Classic R&B	4359	[Mg]EA_Retro Dsc_C	4 / 4	4	108		●	:
Bass	Classic R&B	4360	[Mg]EB_Retro Dsc_C	4 / 4	4	108		●	:
Bass	Classic R&B	4361	[Mg]MA_70CoolDsc_C	4 / 4	4	114		●	:
Bass	Classic R&B	4362	[Mg]MB_70CoolDsc_C	4 / 4	4	114		●	:
Bass	Classic R&B	4363	[Mg]MC_70CoolDsc_C	4 / 4	4	114		●	:
Bass	Classic R&B	4364	[Mg]FA_70CoolDsc_C	4 / 4	1	114		●	:
Bass	Classic R&B	4365	[Mg]FB_70CoolDsc_C	4 / 4	1	114		●	:
Bass	Classic R&B	4366	[Mg]FC_70CoolDsc_C	4 / 4	1	114		●	:
Bass	Classic R&B	4367	[Mg]BA_70CoolDsc_C	4 / 4	1	114		●	:
Bass	Classic R&B	4368	[Mg]EA_70CoolDsc_C	4 / 4	4	114		●	:
Bass	Classic R&B	4369	[Mg]EB_70CoolDsc_C	4 / 4	3	114		●	:
Bass	Classic R&B	4370	[Mg]MA_Philly_C	4 / 4	2	100		●	:
Bass	Classic R&B	4371	[Mg]MB_Philly_C	4 / 4	2	100		●	:
Bass	Classic R&B	4372	[Mg]MC_Philly_C	4 / 4	2	100		●	:
Bass	Classic R&B	4373	[Mg]FA_Philly_C	4 / 4	1	100		●	:
Bass	Classic R&B	4374	[Mg]FB_Philly_C	4 / 4	1	100		●	:
Bass	Classic R&B	4375	[Mg]FC_Philly_C	4 / 4	1	100		●	:
Bass	Classic R&B	4376	[Mg]BA_Philly_C	4 / 4	1	100		●	:
Bass	Classic R&B	4377	[Mg]EA_Philly_C	4 / 4	4	100		●	:
Bass	Classic R&B	4378	[Mg]EB_Philly_C	4 / 4	3	100		●	:
Bass	Classic R&B	4379	[Mg]MA_Soul 1_C	4 / 4	2	116		●	:
Bass	Classic R&B	4380	[Mg]MB_Soul 1_C	4 / 4	2	116		●	:
Bass	Classic R&B	4381	[Mg]MC_Soul 1_C	4 / 4	2	116		●	:
Bass	Classic R&B	4382	[Mg]FA_Soul 1_C	4 / 4	1	116		●	:
Bass	Classic R&B	4383	[Mg]FB_Soul 1_C	4 / 4	1	116		●	:
Bass	Classic R&B	4384	[Mg]FC_Soul 1_C	4 / 4	1	116		●	:
Bass	Classic R&B	4385	[Mg]BA_Soul 1_C	4 / 4	1	116		●	:
Bass	Classic R&B	4386	[Mg]EA_Soul 1_C	4 / 4	4	116		●	:
Bass	Classic R&B	4387	[Mg]EB_Soul 1_C	4 / 4	3	116		●	:
Bass	Classic R&B	4388	[Mg]MA_70ChrSoul_C	4 / 4	2	108		●	:
Bass	Classic R&B	4389	[Mg]MB_70ChrSoul_C	4 / 4	2	108		●	:
Bass	Classic R&B	4390	[Mg]MC_70ChrSoul_C	4 / 4	2	108		●	:
Bass	Classic R&B	4391	[Mg]FA_70ChrSoul_C	4 / 4	1	108		●	:
Bass	Classic R&B	4392	[Mg]FB_70ChrSoul_C	4 / 4	1	108		●	:
Bass	Classic R&B	4393	[Mg]FC_70ChrSoul_C	4 / 4	1	108		●	:
Bass	Classic R&B	4394	[Mg]BA_70ChrSoul_C	4 / 4	1	108		●	:
Bass	Classic R&B	4395	[Mg]EA_70ChrSoul_C	4 / 4	5	108		●	:
Bass	Classic R&B	4396	[Mg]EB_70ChrSoul_C	4 / 4	3	108		●	:
Bass	Classic R&B	4397	[Mg]MA_FrankSoul_C	4 / 4	4	120		●	:
Bass	Classic R&B	4398	[Mg]MB_FrankSoul_C	4 / 4	4	120		●	:
Bass	Classic R&B	4399	[Mg]MC_FrankSoul_C	4 / 4	4	120		●	:
Bass	Classic R&B	4400	[Mg]FA_FrankSoul_C	4 / 4	1	120		●	:
Bass	Classic R&B	4401	[Mg]FB_FrankSoul_C	4 / 4	1	120		●	:
Bass	Classic R&B	4402	[Mg]FC_FrankSoul_C	4 / 4	1	120		●	:
Bass	Classic R&B	4403	[Mg]BA_FrankSoul_C	4 / 4	1	120		●	:
Bass	Classic R&B	4404	[Mg]EA_FrankSoul_C	4 / 4	3	120		●	:
Bass	Classic R&B	4405	[Mg]EB_FrankSoul_C	4 / 4	4	120		●	:
Bass	Classic R&B	4406	[Mg]MA_Soul Band_C	4 / 4	4	129		●	:
Bass	Classic R&B	4407	[Mg]MB_Soul Band_C	4 / 4	4	129		●	:
Bass	Classic R&B	4408	[Mg]MC_Soul Band_C	4 / 4	4	129		●	:
Bass	Classic R&B	4409	[Mg]FA_Soul Band_C	4 / 4	1	129		●	:
Bass	Classic R&B	4410	[Mg]FB_Soul Band_C	4 / 4	1	129		●	:
Bass	Classic R&B	4411	[Mg]FC_Soul Band_C	4 / 4	1	129		●	:
Bass	Classic R&B	4412	[Mg]BA_Soul Band_C	4 / 4	1	129		●	:
Bass	Classic R&B	4413	[Mg]MA_SoulShuff_C	4 / 4	4	98		●	:
Bass	Classic R&B	4414	[Mg]MB_SoulShuff_C	4 / 4	4	98		●	:
Bass	Classic R&B	4415	[Mg]MC_SoulShuff_C	4 / 4	4	98		●	:
Bass	Classic R&B	4416	[Mg]FA_SoulShuff_C	4 / 4	1	98		●	:
Bass	Classic R&B	4417	[Mg]FB_SoulShuff_C	4 / 4	1	98		●	:
Bass	Classic R&B	4418	[Mg]FC_SoulShuff_C	4 / 4	1	98		●	:
Bass	Classic R&B	4419	[Mg]BA_SoulShuff_C	4 / 4	1	98		●	:
Bass	Classic R&B	4420	[Mg]EA_SoulShuff_C	4 / 4	3	98		●	:
Bass	Classic R&B	4421	[Mg]EB_SoulShuff_C	4 / 4	3	98		●	:
Bass	Classic R&B	4422	[Mg]MA_SoulSwing_C	4 / 4	4	124		●	:
Bass	Classic R&B	4423	[Mg]MB_SoulSwing_C	4 / 4	4	124		●	:
Bass	Classic R&B	4424	[Mg]MC_SoulSwing_C	4 / 4	4	124		●	:
Bass	Classic R&B	4425	[Mg]FA_SoulSwing_C	4 / 4	1	124		●	:
Bass	Classic R&B	4426	[Mg]FB_SoulSwing_C	4 / 4	1	124		●	:
Bass	Classic R&B	4427	[Mg]FC_SoulSwing_C	4 / 4	1	124		●	:
Bass	Classic R&B	4428	[Mg]BA_SoulSwing_C	4 / 4	1	124		●	:
Bass	Classic R&B	4429	[Mg]EA_SoulSwing_C	4 / 4	3	123		●	:
Bass	Classic R&B	4430	[Mg]EB_SoulSwing_C	4 / 4	5	123		●	:
Bass	Classic R&B	4431	[Mg]MA_Gospel Br_C	4 / 4	4	108		●	:
Bass	Classic R&B	4432	[Mg]MB_Gospel Br_C	4 / 4	4	108		●	:
Bass	Classic R&B	4433	[Mg]MC_Gospel Br_C	4 / 4	4	108		●	:
Bass	Classic R&B	4434	[Mg]FA_Gospel Br_C	4 / 4	1	108		●	:
Bass	Classic R&B	4435	[Mg]FB_Gospel Br_C	4 / 4	1	108		●	:

Main Category	Sub Category	ARP No.	ARP Name	Time Signature	Length	Original Tempo	Accent	Random SFX	Sound Type
Bass	Classic R&B	4436	[Mg]FC_Gospel Br_C	4 / 4	1	108		●	:
Bass	Classic R&B	4437	[Mg]BA_Gospel Br_C	4 / 4	1	108		●	:
Bass	Classic R&B	4438	[Mg]EA_Gospel Br_C	4 / 4	4	108		●	:
Bass	Classic R&B	4439	[Mg]EB_Gospel Br_C	4 / 4	3	108		●	:
Bass	Funk	4440	[Mg]MA_UrbanFunk_C	4 / 4	4	115		●	:
Bass	Funk	4441	[Mg]MB_UrbanFunk_C	4 / 4	4	115		●	:
Bass	Funk	4442	[Mg]MC_UrbanFunk_C	4 / 4	4	115		●	:
Bass	Funk	4443	[Mg]MD_UrbanFunk_C	4 / 4	4	115		●	:
Bass	Funk	4444	[Mg]FA_UrbanFunk_C	4 / 4	1	115		●	:
Bass	Funk	4445	[Mg]FB_UrbanFunk_C	4 / 4	1	115		●	:
Bass	Funk	4446	[Mg]FC_UrbanFunk_C	4 / 4	1	115		●	:
Bass	Funk	4447	[Mg]FD_UrbanFunk_C	4 / 4	1	115		●	:
Bass	Funk	4448	[Mg]EA_UrbanFunk_C	4 / 4	5	115		●	:
Bass	Funk	4449	[Mg]MA_Funk 1_C	4 / 4	8	104		●	:
Bass	Funk	4450	[Mg]MB_Funk 1_C	4 / 4	8	104		●	:
Bass	Funk	4451	[Mg]MC_Funk 1_C	4 / 4	8	104		●	:
Bass	Funk	4452	[Mg]FA_Funk 1_C	4 / 4	1	104		●	:
Bass	Funk	4453	[Mg]FB_Funk 1_C	4 / 4	1	104		●	:
Bass	Funk	4454	[Mg]FC_Funk 1_C	4 / 4	1	104		●	:
Bass	Funk	4455	[Mg]BA_Funk 1_C	4 / 4	1	104		●	:
Bass	Funk	4456	[Mg]EA_Funk 1_C	4 / 4	9	104		●	:
Bass	Funk	4457	[Mg]EB_Funk 1_C	4 / 4	4	104		●	:
Bass	Funk	4458	[Mg]MA_FunkPopRk_C	4 / 4	4	95		●	:
Bass	Funk	4459	[Mg]MB_FunkPopRk_C	4 / 4	4	95		●	:
Bass	Funk	4460	[Mg]MC_FunkPopRk_C	4 / 4	4	95		●	:
Bass	Funk	4461	[Mg]FA_FunkPopRk_C	4 / 4	1	95		●	:
Bass	Funk	4462	[Mg]FB_FunkPopRk_C	4 / 4	1	95		●	:
Bass	Funk	4463	[Mg]FC_FunkPopRk_C	4 / 4	1	95		●	:
Bass	Funk	4464	[Mg]BA_FunkPopRk_C	4 / 4	1	95		●	:
Bass	Funk	4465	[Mg]EA_FunkPopRk_C	4 / 4	4	94		●	:
Bass	Funk	4466	[Mg]EB_FunkPopRk_C	4 / 4	3	94		●	:
Bass	Funk	4467	[Mg]MA_JazzFunk1_C	4 / 4	4	120		●	:
Bass	Funk	4468	[Mg]MB_JazzFunk1_C	4 / 4	4	120		●	:
Bass	Funk	4469	[Mg]MC_JazzFunk1_C	4 / 4	4	120		●	:
Bass	Funk	4470	[Mg]FA_JazzFunk1_C	4 / 4	1	120		●	:
Bass	Funk	4471	[Mg]FB_JazzFunk1_C	4 / 4	1	120		●	:
Bass	Funk	4472	[Mg]FC_JazzFunk1_C	4 / 4	1	120		●	:
Bass	Funk	4473	[Mg]BA_JazzFunk1_C	4 / 4	1	120		●	:
Bass	Funk	4474	[Mg]EA_JazzFunk1_C	4 / 4	3	120		●	:
Bass	Funk	4475	[Mg]EB_JazzFunk1_C	4 / 4	3	120		●	:
Bass	Funk	4476	[Mg]MA_Jazz Pop_C	4 / 4	2	102		●	:
Bass	Funk	4477	[Mg]MB_Jazz Pop_C	4 / 4	2	102		●	:
Bass	Funk	4478	[Mg]MC_Jazz Pop_C	4 / 4	2	102		●	:
Bass	Funk	4479	[Mg]FA_Jazz Pop_C	4 / 4	1	102		●	:
Bass	Funk	4480	[Mg]FB_Jazz Pop_C	4 / 4	1	102		●	:
Bass	Funk	4481	[Mg]FC_Jazz Pop_C	4 / 4	1	102		●	:
Bass	Funk	4482	[Mg]BA_Jazz Pop_C	4 / 4	1	102		●	:
Bass	Funk	4483	[Mg]MA_GospelFnk_C	4 / 4	4	106		●	:
Bass	Funk	4484	[Mg]MB_GospelFnk_C	4 / 4	4	106		●	:
Bass	Funk	4485	[Mg]MC_GospelFnk_C	4 / 4	4	106		●	:
Bass	Funk	4486	[Mg]FA_GospelFnk_C	4 / 4	1	106		●	:
Bass	Funk	4487	[Mg]FB_GospelFnk_C	4 / 4	1	106		●	:
Bass	Funk	4488	[Mg]FC_GospelFnk_C	4 / 4	1	106		●	:
Bass	Funk	4489	[Mg]BA_GospelFnk_C	4 / 4	1	106		●	:
Bass	Funk	4490	[Mg]EA_GospelFnk_C	4 / 4	4	106		●	:
Bass	Funk	4491	[Mg]EB_GospelFnk_C	4 / 4	3	106		●	:
Bass	Funk	4492	[Mg]MA_Funk Dsc_C	4 / 4	2	126		●	:
Bass	Funk	4493	[Mg]MB_Funk Dsc_C	4 / 4	2	126		●	:
Bass	Funk	4494	[Mg]MC_Funk Dsc_C	4 / 4	2	126		●	:
Bass	Funk	4495	[Mg]FA_Funk Dsc_C	4 / 4	1	126		●	:
Bass	Funk	4496	[Mg]FB_Funk Dsc_C	4 / 4	1	126		●	:
Bass	Funk	4497	[Mg]FC_Funk Dsc_C	4 / 4	1	126		●	:
Bass	Funk	4498	[Mg]BA_Funk Dsc_C	4 / 4	1	126		●	:
Bass	Funk	4499	[Mg]EA_Funk Dsc_C	4 / 4	4	126		●	:
Bass	Funk	4500	[Mg]EB_Funk Dsc_C	4 / 4	3	126		●	:
Bass	Funk								

Main Category	Sub Category	ARP No.	ARP Name	Time Signature	Length	Original Tempo	Accent	Random SFX	Sound Type
Bass	Jazz	4523	[Mg]FA_JzGrClub_C	4 / 4	1	142		•	:
Bass	Jazz	4524	[Mg]FB_JzGrClub_C	4 / 4	1	142		•	:
Bass	Jazz	4525	[Mg]FC_JzGrClub_C	4 / 4	1	142		•	:
Bass	Jazz	4526	[Mg]BA_JzGrClub_C	4 / 4	1	142		•	:
Bass	Jazz	4527	[Mg]EA_JzGrClub_C	4 / 4	6	142		•	:
Bass	Jazz	4528	[Mg]MA_JazWizMed_C	3 / 4	8	180		•	:
Bass	Jazz	4529	[Mg]MB_JazWizMed_C	3 / 4	8	180		•	:
Bass	Jazz	4530	[Mg]MC_JazWizMed_C	3 / 4	8	180		•	:
Bass	Jazz	4531	[Mg]FA_JazWizMed_C	3 / 4	1	180		•	:
Bass	Jazz	4532	[Mg]FB_JazWizMed_C	3 / 4	1	180		•	:
Bass	Jazz	4533	[Mg]FC_JazWizMed_C	3 / 4	1	180		•	:
Bass	Jazz	4534	[Mg]BA_JazWizMed_C	3 / 4	1	180		•	:
Bass	Jazz	4535	[Mg]EA_JazWizMed_C	3 / 4	7	180		•	:
Bass	Jazz	4536	[Mg]MA_R&R Shuff_C	4 / 4	4	192		•	:
Bass	Jazz	4537	[Mg]MB_R&R Shuff_C	4 / 4	4	192		•	:
Bass	Jazz	4538	[Mg]MC_R&R Shuff_C	4 / 4	4	192		•	:
Bass	Jazz	4539	[Mg]FA_R&R Shuff_C	4 / 4	1	192		•	:
Bass	Jazz	4540	[Mg]FB_R&R Shuff_C	4 / 4	1	192		•	:
Bass	Jazz	4541	[Mg]FC_R&R Shuff_C	4 / 4	1	192		•	:
Bass	Jazz	4542	[Mg]BA_R&R Shuff_C	4 / 4	1	192		•	:
Bass	Jazz	4543	[Mg]EA_R&R Shuff_C	4 / 4	5	192		•	:
Bass	Jazz	4544	[Mg]EB_R&R Shuff_C	4 / 4	5	192		•	:
Bass	Jazz	4545	[Mg]MA_ShlBlues_C	4 / 4	4	115		•	Mega Pick Open Mute
Bass	Jazz	4546	[Mg]MB_ShlBlues_C	4 / 4	4	115		•	:
Bass	Jazz	4547	[Mg]MC_ShlBlues_C	4 / 4	4	115		•	:
Bass	Jazz	4548	[Mg]FA_ShlBlues_C	4 / 4	1	115		•	:
Bass	Jazz	4549	[Mg]FB_ShlBlues_C	4 / 4	1	115		•	:
Bass	Jazz	4550	[Mg]FC_ShlBlues_C	4 / 4	1	115		•	:
Bass	Jazz	4551	[Mg]BA_ShlBlues_C	4 / 4	1	115		•	:
Bass	Jazz	4552	[Mg]EA_ShlBlues_C	4 / 4	5	115		•	:
Bass	Jazz	4553	[Mg]EB_ShlBlues_C	4 / 4	6	115		•	:
Bass	Jazz	4554	[Mg]MA_SlwBlues1_C	4 / 4	2	49		•	Mega Finger+Slap
Bass	Jazz	4555	[Mg]MB_SlwBlues1_C	4 / 4	2	49		•	:
Bass	Jazz	4556	[Mg]MC_SlwBlues1_C	4 / 4	2	49		•	:
Bass	Jazz	4557	[Mg]FA_SlwBlues1_C	4 / 4	1	49		•	:
Bass	Jazz	4558	[Mg]FB_SlwBlues1_C	4 / 4	1	49		•	:
Bass	Jazz	4559	[Mg]FC_SlwBlues1_C	4 / 4	1	49		•	:
Bass	Jazz	4560	[Mg]BA_SlwBlues1_C	4 / 4	1	49		•	:
Bass	Jazz	4561	[Mg]EA_SlwBlues1_C	4 / 4	3	49		•	:
Bass	Jazz	4562	[Mg]EB_SlwBlues1_C	4 / 4	3	49		•	:
Bass	Jazz	4563	[Mg]MA_PnoBoogie_C	4 / 4	8	160		•	Mega Acoustic Bass
Bass	Jazz	4564	[Mg]MB_PnoBoogie_C	4 / 4	4	160		•	:
Bass	Jazz	4565	[Mg]MC_PnoBoogie_C	4 / 4	4	160		•	:
Bass	Jazz	4566	[Mg]FA_PnoBoogie_C	4 / 4	1	160		•	:
Bass	Jazz	4567	[Mg]FB_PnoBoogie_C	4 / 4	1	160		•	:
Bass	Jazz	4568	[Mg]FC_PnoBoogie_C	4 / 4	1	160		•	:
Bass	Jazz	4569	[Mg]BA_PnoBoogie_C	4 / 4	1	160		•	:
Bass	Jazz	4570	[Mg]EA_PnoBoogie_C	4 / 4	5	160		•	:
Bass	Jazz	4571	[Mg]EB_PnoBoogie_C	4 / 4	5	160		•	:
Bass	Latin	4572	[Mg]MA_Salsa1_C	4 / 4	4	177		•	:
Bass	Latin	4573	[Mg]MB_Salsa1_C	4 / 4	4	177		•	:
Bass	Latin	4574	[Mg]MC_Salsa1_C	4 / 4	4	177		•	:
Bass	Latin	4575	[Mg]FA_Salsa1_C	4 / 4	1	177		•	:
Bass	Latin	4576	[Mg]FB_Salsa1_C	4 / 4	1	177		•	:
Bass	Latin	4577	[Mg]FC_Salsa1_C	4 / 4	1	177		•	:
Bass	Latin	4578	[Mg]BA_Salsa1_C	4 / 4	1	177		•	:
Bass	Latin	4579	[Mg]EA_Salsa1_C	4 / 4	5	177		•	:
Bass	Latin	4580	[Mg]EB_Salsa1_C	4 / 4	5	177		•	:
Bass	Latin	4581	[Mg]MA_AfroCuban_C	4 / 4	4	200		•	:
Bass	Latin	4582	[Mg]MB_AfroCuban_C	4 / 4	4	200		•	:
Bass	Latin	4583	[Mg]MC_AfroCuban_C	4 / 4	4	200		•	:
Bass	Latin	4584	[Mg]FA_AfroCuban_C	4 / 4	1	200		•	:
Bass	Latin	4585	[Mg]FB_AfroCuban_C	4 / 4	1	200		•	:
Bass	Latin	4586	[Mg]FC_AfroCuban_C	4 / 4	1	200		•	:
Bass	Latin	4587	[Mg]BA_AfroCuban_C	4 / 4	1	200		•	:
Bass	Latin	4588	[Mg]EA_AfroCuban_C	4 / 4	6	200		•	:
Bass	Latin	4589	[Mg]EB_AfroCuban_C	4 / 4	5	200		•	:
Bass	Latin	4590	[Mg]MA_BrzSamba_C	4 / 4	4	96		•	Mega Finger+Slap
Bass	Latin	4591	[Mg]MB_BrzSamba_C	4 / 4	4	96		•	:
Bass	Latin	4592	[Mg]MC_BrzSamba_C	4 / 4	4	96		•	:
Bass	Latin	4593	[Mg]FA_BrzSamba_C	4 / 4	1	96		•	:
Bass	Latin	4594	[Mg]FB_BrzSamba_C	4 / 4	1	96		•	:
Bass	Latin	4595	[Mg]FC_BrzSamba_C	4 / 4	1	96		•	:
Bass	Latin	4596	[Mg]BA_BrzSamba_C	4 / 4	1	96		•	:
Bass	Latin	4597	[Mg]EA_BrzSamba_C	4 / 4	4	96		•	:
Bass	Latin	4598	[Mg]EB_BrzSamba_C	4 / 4	4	96		•	:
Bass	Latin	4599	[Mg]MA_Bomba_C	4 / 4	4	99		•	Mega Acoustic Bass
Bass	Latin	4600	[Mg]MB_Bomba_C	4 / 4	4	99		•	:
Bass	Latin	4601	[Mg]MC_Bomba_C	4 / 4	4	99		•	:
Bass	Latin	4602	[Mg]FA_Bomba_C	4 / 4	1	99		•	:
Bass	Latin	4603	[Mg]FB_Bomba_C	4 / 4	1	99		•	:
Bass	Latin	4604	[Mg]FC_Bomba_C	4 / 4	1	99		•	:
Bass	Latin	4605	[Mg]BA_Bomba_C	4 / 4	1	99		•	:
Bass	Latin	4606	[Mg]EA_Bomba_C	4 / 4	3	99		•	:
Bass	Latin	4607	[Mg]EB_Bomba_C	4 / 4	3	99		•	:
Bass	Latin	4608	[Mg]MA_Bossa_C	4 / 4	4	124		•	Mega Finger+Slap
Bass	Latin	4609	[Mg]MB_Bossa_C	4 / 4	4	124		•	:

Main Category	Sub Category	ARP No.	ARP Name	Time Signature	Length	Original Tempo	Accent	Random SFX	Sound Type
Bass	Latin	4610	[Mg]MC_Bossa_C	4 / 4	4	124		•	:
Bass	Latin	4611	[Mg]FA_Bossa_C	4 / 4	1	124		•	:
Bass	Latin	4612	[Mg]FB_Bossa_C	4 / 4	1	124		•	:
Bass	Latin	4613	[Mg]FC_Bossa_C	4 / 4	1	124		•	:
Bass	Latin	4614	[Mg]BA_Bossa_C	4 / 4	1	124		•	:
Bass	Latin	4615	[Mg]EA_Bossa_C	4 / 4	4	123		•	:
Bass	Latin	4616	[Mg]EB_Bossa_C	4 / 4	4	123		•	:
Bass	Latin	4617	[Mg]MA_Merengue_C	4 / 4	4	130		•	:
Bass	Latin	4618	[Mg]MB_Merengue_C	4 / 4	4	130		•	:
Bass	Latin	4619	[Mg]MC_Merengue_C	4 / 4	4	130		•	:
Bass	Latin	4620	[Mg]FA_Merengue_C	4 / 4	1	130		•	:
Bass	Latin	4621	[Mg]FB_Merengue_C	4 / 4	1	130		•	:
Bass	Latin	4622	[Mg]FC_Merengue_C	4 / 4	1	130		•	:
Bass	Latin	4623	[Mg]BA_Merengue_C	4 / 4	1	130		•	:
Bass	Latin	4624	[Mg]EA_Merengue_C	4 / 4	3	130		•	:
Bass	Latin	4625	[Mg]EB_Merengue_C	4 / 4	3	130		•	:
Bass	Latin	4626	[Mg]MA_Guaguanco_C	4 / 4	4	120		•	Mega Acoustic Bass
Bass	Latin	4627	[Mg]MB_Guaguanco_C	4 / 4	4	120		•	:
Bass	Latin	4628	[Mg]MC_Guaguanco_C	4 / 4	4	120		•	:
Bass	Latin	4629	[Mg]FA_Guaguanco_C	4 / 4	1	120		•	:
Bass	Latin	4630	[Mg]FB_Guaguanco_C	4 / 4	1	120		•	:
Bass	Latin	4631	[Mg]FC_Guaguanco_C	4 / 4	1	120		•	:
Bass	Latin	4632	[Mg]BA_Guaguanco_C	4 / 4	1	120		•	:
Bass	Latin	4633	[Mg]EA_Guaguanco_C	4 / 4	3	120		•	:
Bass	Latin	4634	[Mg]EB_Guaguanco_C	4 / 4	3	120		•	:
Bass	World	4635	[Mg]MA_ReggaeShi_C	4 / 4	4	90		•	Mega Finger+Slap
Bass	World	4636	[Mg]MB_ReggaeShi_C	4 / 4	4	90		•	:
Bass	World	4637	[Mg]MC_ReggaeShi_C	4 / 4	4	90		•	:
Bass	World	4638	[Mg]FA_ReggaeShi_C	4 / 4	1	90		•	:
Bass	World	4639	[Mg]FB_ReggaeShi_C	4 / 4	1	90		•	:
Bass	World	4640	[Mg]FC_ReggaeShi_C	4 / 4	1	90		•	:
Bass	World	4641	[Mg]BA_ReggaeShi_C	4 / 4	1	90		•	:
Bass	World	4642	[Mg]EA_ReggaeShi_C	4 / 4	3	90		•	:
Bass	World	4643	[Mg]EB_ReggaeShi_C	4 / 4	4	90		•	:
Bass	World	4644	[Mg]MA_RmbFlamnc_C	4 / 4	4	106		•	:
Bass	World	4645	[Mg]MB_RmbFlamnc_C	4 / 4	4	106		•	:
Bass	World	4646	[Mg]MC_RmbFlamnc_C	4 / 4	4	106		•	:
Bass	World	4647	[Mg]FA_RmbFlamnc_C	4 / 4	1	106		•	:
Bass	World	4648	[Mg]FB_RmbFlamnc_C	4 / 4	1	106		•	:
Bass	World	4649	[Mg]FC_RmbFlamnc_C	4 / 4	1	106		•	:
Bass	World	4650	[Mg]BA_RmbFlamnc_C	4 / 4	1	106		•	:
Bass	World	4651	[Mg]EA_RmbFlamnc_C	4 / 4	3	106		•	:
Bass	World	4652	[Mg]EB_RmbFlamnc_C	4 / 4	3	106		•	:
Bass	World	4653	[Mg]MA_ModBlugs_C	4 / 4	4	121		•	Mega Finger+Harmonic
Bass	World	4654	[Mg]MB_ModBlugs_C	4 / 4	4	121		•	:
Bass	World	4655	[Mg]MC_ModBlugs_C	4 / 4	4	121		•	:
Bass	World	4656	[Mg]FA_ModBlugs_C	4 / 4	1	121		•	:
Bass	World	4657	[Mg]FB_ModBlugs_C	4 / 4	1	121		•	:
Bass	World	4658	[Mg]FC_ModBlugs_C	4 / 4	1	121		•	:
Bass	World	4659	[Mg]BA_ModBlugs_C	4 / 4	1	121		•	:
Bass	World	4660	[Mg]EA_ModBlugs_C	4 / 4	6	121		•	:
Bass	World	4661	[Mg]MA_IrishHymn_C	3 / 4	4	70		•	Mega Finger+Slap
Bass	World	4662	[Mg]MB_IrishHymn_C	3 / 4	4	70		•	:
Bass	World	4663	[Mg]MC_IrishHymn_C	3 / 4	4	70		•	:
Bass	World	4664	[Mg]FA_IrishHymn_C	3 / 4	1	70		•	:
Bass	World	4665	[Mg]FB_IrishHymn_C	3 / 4	1	70		•	:
Bass	World	4666	[Mg]FC_IrishHymn_C	3 / 4	1	70		•	:
Bass	World	4667	[Mg]BA_IrishHymn_C	3 / 4	1	70		•	:
Bass	World	4668	[Mg]EA_IrishHymn_C	3 / 4	5	70		•	:
Bass	World	4669	[Mg]EB_IrishHymn_C	3 / 4	5	70		•	:
Bass	World	4670	[Mg]MA_Saeidy1_C	4 / 4	2	120		•	:
Bass	World	4671	[Mg]MB_Saeidy1_C	4 / 4	2	120		•	:
Bass	World	4672	[Mg]MC_Saeidy1_C	4 / 4	4	120		•	:
Bass	World	4673	[Mg]FA_Saeidy1_C	4 / 4	1	120		•	:
Bass	World	4674	[Mg]FB_Saeidy1_C	4 / 4	1	120		•	:
Bass	World	4675	[Mg]FC_Saeidy1_C	4 / 4	1	120		•	:
Bass	World	4676	[Mg]BA_Saeidy1_C	4 / 4	1	120		•	:
Bass	World	4677	[Mg]EA_Saeidy1_C	4 / 4	4	120		•	:
Str	Pop Rock	4678	MA_Straight Shot_N	4 / 4	1	120		•	Viola
Str	Pop Rock	4679	MA_Bow Push_N	4 /					

Main Category	Sub Category	ARP No.	ARP Name	Time Signature	Length	Original Tempo	Accent	Random SFX	Sound Type
Str	Modern R&B	4697	MD_New R&B 2	4/4	1	97			:
Str	Modern R&B	4698	MA_New R&B 3_N	4/4	2	90			Strings
Str	Modern R&B	4699	MB_New R&B 3_N	4/4	2	90			:
Str	Modern R&B	4700	MC_New R&B 3_N	4/4	2	90			:
Str	Modern R&B	4701	MD_New R&B 3/1_N	4/4	2	90			:
Str	Modern R&B	4702	MD_New R&B 3/2_N	4/4	2	90			:
Str	Modern R&B	4703	FA_New R&B 3_N	4/4	1	90			:
Str	Modern R&B	4704	FC_New R&B 3_N	4/4	2	90			:
Str	Modern R&B	4705	MA_Pop R&B_C	4/4	4	67			:
Str	Modern R&B	4706	MB_Pop R&B_C	4/4	4	67			:
Str	Modern R&B	4707	MC_Pop R&B_C	4/4	4	67			:
Str	Modern R&B	4708	FA_Pop R&B_C	4/4	1	67			:
Str	Modern R&B	4709	FB_Pop R&B_C	4/4	1	67			:
Str	Modern R&B	4710	FC_Pop R&B_C	4/4	1	67			:
Str	Modern R&B	4711	MA1_R&B Ana Pop_C	4/4	4	95			Harp
Str	Modern R&B	4712	MB1_R&B Ana Pop_C	4/4	4	95			:
Str	Modern R&B	4713	MC1_R&B Ana Pop_C	4/4	4	95			:
Str	Modern R&B	4714	FA1_R&B Ana Pop_C	4/4	1	95			:
Str	Modern R&B	4715	FB1_R&B Ana Pop_C	4/4	1	95			:
Str	Modern R&B	4716	FC1_R&B Ana Pop_C	4/4	1	95			:
Str	Modern R&B	4717	BA1_R&B Ana Pop_C	4/4	1	95			:
Str	Modern R&B	4718	MA2_R&B Ana Pop_C	4/4	4	95			Strings
Str	Modern R&B	4719	MB2_R&B Ana Pop_C	4/4	4	95			:
Str	Modern R&B	4720	MC2_R&B Ana Pop_C	4/4	4	95			:
Str	Modern R&B	4721	FA2_R&B Ana Pop_C	4/4	1	95			:
Str	Modern R&B	4722	FB2_R&B Ana Pop_C	4/4	1	95			:
Str	Modern R&B	4723	FC2_R&B Ana Pop_C	4/4	1	95			:
Str	Modern R&B	4724	MC_Smooth 1_N	4/4	2	115			Pizzicato Strings
Str	Modern R&B	4725	MD_Smooth 1_N	4/4	2	115			:
Str	Modern R&B	4726	MC_Flip Hop 1_N	4/4	2	132			:
Str	Modern R&B	4727	MD_Flip Hop 1_N	4/4	2	132			:
Str	Modern R&B	4728	FB_Flip Hop 1_N	4/4	1	132			:
Str	Modern R&B	4729	MC_Hip Hop 1_N	4/4	2	105			:
Str	Modern R&B	4730	MD_Hip Hop 1_N	4/4	2	105			:
Str	Modern R&B	4731	FB_Hip Hop 1_N	4/4	1	105			:
Str	Modern R&B	4732	MD_Hip Hop 3_N	4/4	2	104			Harp
Str	Techno	4733	MA_Side 2 Side_N	4/4	1	130			Strings
Str	Techno	4734	MA_Psyche Pizz1_N	4/4	1	143			Pizzicato Strings
Str	Techno	4735	MA_Psyche Pizz2_N	4/4	1	143			:
Str	Techno	4736	MA_Psyche Pizz3_N	4/4	2	143			:
Str	Techno	4737	MA_Psyche Pizz4_N	4/4	3	143			:
Str	Techno	4738	MA_Psyche Pizz5_N	4/4	2	143			:
Str	Chill	4739	MA_Dirt Mello	4/4	1	110			Strings
Str	World	4740	MA_Irish Hymn_C	3/4	4	70			:
Str	World	4741	MB_Irish Hymn_C	3/4	4	70			:
Str	World	4742	MC_Irish Hymn_C	3/4	4	70			:
Str	World	4743	FA_Irish Hymn_C	3/4	1	70			:
Str	World	4744	FB_Irish Hymn_C	3/4	1	70			:
Str	World	4745	FC_Irish Hymn_C	3/4	1	70			:
Str	World	4746	BA_Irish Hymn_C	3/4	1	70			:
Str	World	4747	EA_Irish Hymn_C	3/4	5	70			:
Str	World	4748	EB_Irish Hymn_C	3/4	5	70			:
Str	World	4749	MD_Turkish_N	9/8	2	125			:
Str	World	4750	MF_Turkish_N	4/4	2	105			:
Str	World	4751	IA_Turkish_N	4/4	2	86			:
Str	General	4752	MA1_Orchestra_C	4/4	4	102			:
Str	General	4753	MB1_Orchestra_C	4/4	8	102			:
Str	General	4754	MC1_Orchestra_C	4/4	8	102			:
Str	General	4755	MD1_Orchestra_C	4/4	4	102			:
Str	General	4756	FA1_Orchestra_C	4/4	1	102			:
Str	General	4757	MA2_Orchestra_C	4/4	4	102			Harp
Str	General	4758	MB2_Orchestra_C	4/4	8	102			:
Str	General	4759	MC2_Orchestra_C	4/4	8	102			:
Str	General	4760	MD2_Orchestra_C	4/4	4	102			:
Str	General	4761	FA2_Orchestra_C	4/4	1	102			:
Str	General	4762	MA1_Baroque_C	4/4	4	88			Strings
Str	General	4763	MB1_Baroque_C	4/4	4	88			:
Str	General	4764	MC1_Baroque_C	4/4	4	88			:
Str	General	4765	MD1_Baroque_C	4/4	4	88			:
Str	General	4766	FA1_Baroque_C	4/4	1	88			:
Str	General	4767	FB1_Baroque_C	4/4	1	88			:
Str	General	4768	FC1_Baroque_C	4/4	1	88			:
Str	General	4769	FD1_Baroque_C	4/4	1	88			:
Str	General	4770	MA2_Baroque_C	4/4	4	88			:
Str	General	4771	MB2_Baroque_C	4/4	4	88			:
Str	General	4772	MC2_Baroque_C	4/4	4	88			:
Str	General	4773	MD2_Baroque_C	4/4	4	88			:
Str	General	4774	FA2_Baroque_C	4/4	1	88			:
Str	General	4775	FB2_Baroque_C	4/4	1	88			:
Str	General	4776	FC2_Baroque_C	4/4	1	88			:
Str	General	4777	FD2_Baroque_C	4/4	1	88			:
Str	General	4778	MA_Strings1	4/4	1	101			:
Str	General	4779	MA_Strings2	4/4	1	101			:
Str	General	4780	MA_Strings3	4/4	1	101			:
Str	General	4781	MA_Strings4	4/4	1	101			:
Str	General	4782	MA_Strings5	4/4	1	101			:
Str	General	4783	MA_Strings6	4/4	1	101			:

Main Category	Sub Category	ARP No.	ARP Name	Time Signature	Length	Original Tempo	Accent	Random SFX	Sound Type
Str	General	4784	MA_Strings7	4/4	1	101			:
Str	General	4785	MA_Strings8	4/4	1	101			:
Str	General	4786	MA_Strings9	4/4	2	120			:
Str	General	4787	MA_Jupiter	4/4	4	120			:
Str	General	4788	MA_Strings Up1_N	4/4	1	120			:
Str	General	4789	MA_StringsDown1_N	4/4	1	120			:
Str	General	4790	MA_Strings Up2_N	4/4	1	120			:
Str	General	4791	MA_StringsDown2_N	4/4	1	120			:
Str	General	4792	MA_Cello1	4/4	2	120			Cello
Str	General	4793	MA_Cello2	4/4	2	120			:
Str	General	4794	MA_OrchStrings	4/4	4	126			Strings
Str	General	4795	MA_OrchChord	4/4	4	126			:
Str	General	4796	MA_Pizz1	4/4	1	120			Pizzicato Strings
Str	General	4797	MA_Pizz2	4/4	1	120			:
Str	General	4798	MA_Pizz3	4/4	1	120			:
Str	General	4799	MA_Pizz4	4/4	1	124			:
Str	General	4800	MA_Pizz5	4/4	1	124			:
Str	General	4801	MA_Harp1	4/4	2	120			Harp
Str	General	4802	MA_Harp2	4/4	2	120			:
Str	General	4803	MA_Harp3	4/4	1	120			:
Str	General	4804	MA_Harp4	4/4	1	120			:
Brass	Pop Rock	4805	MA_Your Horn_N	4/4	1	95			Trombone
Brass	Hip Hop	4806	MA_Hip Break_C	4/4	4	98			Brass Section
Brass	Hip Hop	4807	MB_Hip Break_C	4/4	4	98			:
Brass	Hip Hop	4808	MC_Hip Break_C	4/4	4	98			:
Brass	Hip Hop	4809	FA_Hip Break_C	4/4	1	98			:
Brass	Hip Hop	4810	FB_Hip Break_C	4/4	1	98			:
Brass	Hip Hop	4811	FC_Hip Break_C	4/4	1	98			:
Brass	Hip Hop	4812	BA_Hip Break_C	4/4	1	98			:
Brass	Modern R&B	4813	FC_New Gospel	4/4	2	90			:
Brass	Classic R&B	4814	FA_Soul 2	4/4	1	120			:
Brass	Classic R&B	4815	MA_70sChartSoul_C	4/4	2	108			Velo Falls
Brass	Classic R&B	4816	MB_70sChartSoul_C	4/4	2	108			:
Brass	Classic R&B	4817	MC_70sChartSoul_C	4/4	2	108			:
Brass	Classic R&B	4818	FA_70sChartSoul_C	4/4	1	108			:
Brass	Classic R&B	4819	FB_70sChartSoul_C	4/4	1	108			:
Brass	Classic R&B	4820	FC_70sChartSoul_C	4/4	1	108			:
Brass	Classic R&B	4821	BA_70sChartSoul_C	4/4	1	108			:
Brass	Classic R&B	4822	EA_70sChartSoul_C	4/4	5	108			:
Brass	Classic R&B	4823	EB_70sChartSoul_C	4/4	3	108			:
Brass	Funk	4824	MB_Urban Funk_C	4/4	4	115			Brass Section
Brass	Funk	4825	MC_Urban Funk_C	4/4	4	115			:
Brass	Funk	4826	MD_Urban Funk_C	4/4	4	115			:
Brass	Funk	4827	FA_Urban Funk_C	4/4	1	115			:
Brass	Funk	4828	FB_Urban Funk_C	4/4	1	115			:
Brass	Funk	4829	FD_Urban Funk_C	4/4	1	115			:
Brass	Funk	4830	EA_Urban Funk_C	4/4	5	115			:
Brass	Funk	4831	MB_Funk 3	4/4	2	132			:
Brass	Funk	4832	MC_Funk 3	4/4	4	132			:
Brass	Funk	4833	MD_Funk 3	4/4	2	132			:
Brass	Funk	4834	IA_Funk 3	4/4	1	132			:
Brass	Funk	4835	FA_Funk 3	4/4	1	132			:
Brass	Funk	4836	FB_Funk 3	4/4	1	132			:
Brass	Funk	4837	MC_Jazz Funk 2	4/4	4	120			:
Brass	Funk	4838	MD_Jazz Funk 2 /1	4/4	4	120			:
Brass	Funk	4839	MD_Jazz Funk 2 /2	4/4	1	120			:
Brass	Funk	4840	IA_Jazz Funk 2	4/4	1	120			:
Brass	Funk	4841	FA_Jazz Funk 2	4/4	1	120			:
Brass	Latin	4842	MB1_Salsa 2	4/4	1	123			:
Brass	Latin	4843	MC1_Salsa 2	4/4	1	123			:
Brass	Latin	4844	FA1_Salsa 2	4/4	2	123			:
Brass	Latin	4845	MA2_Salsa 2	4/4	1	123			:
Brass	Latin	4846	MB2_Salsa 2	4/4	4	120			:
Brass	Latin	4847	MA3_Salsa 2_N	4/4	2	123			:
Brass	Latin	4848	MB3_Salsa 2_N	4/4	2	123			:
Brass	Latin	4849	MC3_Salsa 2_N	4/4	2	123			:
Brass	Latin	4850	FA3_Salsa 2_N	4/4	1	123			:
Brass	Latin	4851	FC3_Salsa 2_N	4/4	1	123			:
Brass	Latin	4852	MD1_Samba	4/4	4	120			:
Brass	Latin	4853	IA1_Samba	4/4	2	120			:
Brass	Latin	4854	FC1_Samba	4/4	2	120			:
Brass	Latin	4855	MB2_Samba	4/4	4	120			Trombone
Brass	Latin	4856	MC2_Samba	4/4	4	120			:
Brass	World	4857	MC_Turkish	9/8	2	125			Mute Trumpet
Brass	General	4858	MA_Trumpple	4/4	2	145			Trumpet
Brass	General	4859	MA_Orchestra_C	4/4	4	102			French Horn
Brass	General	4860	MB_Orchestra_C	4/4	8	102			:
Brass	General	4861	MC_Orchestra_C	4/4	8	102			:
Brass	General	4862	MD_Orchestra_C	4/4</					

Main Category	Sub Category	ARP No.	ARP Name	Time Signature	Length	Original Tempo	Accent	Random SFX	Sound Type
Brass	General	4871	MA_Brass Sec4	4/4	1	120			:
Brass	General	4872	MA_Brass Sec5	4/4	1	120			:
Brass	General	4873	MA_Brass Sec6	4/4	1	120			:
Brass	General	4874	MA_Brass Sec7	4/4	1	120			:
WW	Hip Hop	4875	MD_Hip Hop 1_N	4/4	2	105			Saxophone
WW	Hip Hop	4876	FC_Hip Hop 1_N	4/4	2	105			:
WW	Classic R&B	4877	MB_Soul 2_N	4/4	4	120			:
WW	Classic R&B	4878	MC_Soul 2_N	4/4	4	120			:
WW	Classic R&B	4879	FB_Soul 2_N	4/4	1	120			:
WW	Classic R&B	4880	FC_Soul 2	4/4	1	120			:
WW	Funk	4881	MA_Club Jazz 2_C	4/4	4	92			Sax Section
WW	Funk	4882	MB_Club Jazz 2_C	4/4	4	92			:
WW	Funk	4883	MC_Club Jazz 2_C	4/4	4	92			:
WW	Funk	4884	FA_Club Jazz 2_C	4/4	1	92			:
WW	Funk	4885	FB_Club Jazz 2_C	4/4	1	92			:
WW	Funk	4886	FC_Club Jazz 2_C	4/4	1	92			:
WW	Funk	4887	BA_Club Jazz 2_C	4/4	1	92			:
WW	Funk	4888	MA_Club Jazz 2_N	4/4	4	92			:
WW	Funk	4889	MB_Club Jazz 2_N	4/4	4	92			:
WW	Funk	4890	MC_Club Jazz 2_N	4/4	4	92			:
WW	Funk	4891	FA_Club Jazz 2_N	4/4	1	92			:
WW	Funk	4892	FB_Club Jazz 2_N	4/4	1	92			:
WW	Funk	4893	FC_Club Jazz 2_N	4/4	1	92			:
WW	Funk	4894	BA_Club Jazz 2_N	4/4	1	92			:
WW	Latin	4895	MA_Samba_N	4/4	2	120			Saxophone
WW	Latin	4896	MC_Samba	4/4	4	120			:
WW	Latin	4897	MD_Samba_N	4/4	4	120			:
WW	Latin	4898	FC_Samba_N	4/4	2	120			:
WW	World	4899	MB2_Turkish_N	4/4	2	105			:
WW	World	4900	MC2_Turkish_N	9/8	2	125			:
WW	World	4901	MD2_Turkish_N	9/8	2	125			:
WW	World	4902	ME2_Turkish	4/4	2	105			:
WW	General	4903	MC_Baroque_C	4/4	4	88			Oboe
WW	General	4904	MD_Baroque_C	4/4	4	88			:
WW	General	4905	FB_Baroque_C	4/4	1	88			:
WW	General	4906	FC_Baroque_C	4/4	1	88			:
WW	General	4907	FD_Baroque_C	4/4	1	88			:
WW	General	4908	Flute Accent_N	4/4	1	102			Flute
WW	General	4909	Flute1	4/4	1	120			:
WW	General	4910	Flute2	4/4	1	120			:
WW	General	4911	Flute3	4/4	1	120			:
WW	General	4912	Flutter1	4/4	1	120			Flute/Reed
WW	General	4913	Flutter2	4/4	1	120			:
WW	General	4914	Flutter3	4/4	1	120			:
SynLd	Hip Hop	4915	MA_SynClassicTrap 1	4/4	4	140			Synth Lead
SynLd	Hip Hop	4916	MA_SynClassicTrap 2	4/4	4	120			:
SynLd	Hip Hop	4917	MA_MEast Riff PB 1	4/4	4	105			:
SynLd	Hip Hop	4918	MA_MEast Riff PB 2	4/4	4	105			:
SynLd	Hip Hop	4919	MA_MEast Riff PB 3	4/4	4	120			:
SynLd	Hip Hop	4920	MA_MEast Riff PB 4	4/4	4	120			:
SynLd	Hip Hop	4921	MA_MEast Riff PB 5	4/4	4	120			:
SynLd	Hip Hop	4922	MA_Simple Melody 1	4/4	4	120			:
SynLd	Hip Hop	4923	MA_Simple Melody 2	4/4	4	120			:
SynLd	Hip Hop	4924	MA_Simple Melody 3	4/4	4	120			:
SynLd	Hip Hop	4925	MA_Harlem	4/4	4	140			:
SynLd	Hip Hop	4926	MA_SimpleM1-01	4/4	4	124			:
SynLd	Hip Hop	4927	MA_SimpleM1-02	4/4	4	130			:
SynLd	Hip Hop	4928	MA_Squid Funk_N	4/4	1	96			:
SynLd	Hip Hop	4929	MA_DirtySynth	4/4	2	85			:
SynLd	Hip Hop	4930	MB_DirtySynth	4/4	2	85			:
SynLd	Hip Hop	4931	MC_DirtySynth	4/4	2	85			:
SynLd	Hip Hop	4932	MD_DirtySynth	4/4	2	85			:
SynLd	Hip Hop	4933	MA_HipHopEpic /1	4/4	2	85			:
SynLd	Hip Hop	4934	MA_HipHopEpic /2_N	4/4	2	85			:
SynLd	Hip Hop	4935	MA_HipHopEpic /3_N	4/4	2	85			:
SynLd	Hip Hop	4936	MA_HipHopEpic /4_N	4/4	2	85			:
SynLd	Hip Hop	4937	MB_Hip Rock 1_C	4/4	4	90			:
SynLd	Hip Hop	4938	MC_Hip Rock 1_C	4/4	4	90			:
SynLd	Hip Hop	4939	FA_Hip Rock 1_C	4/4	1	90			:
SynLd	Hip Hop	4940	FB_Hip Rock 1_C	4/4	1	90			:
SynLd	Hip Hop	4941	FC_Hip Rock 1_C	4/4	1	90			:
SynLd	Hip Hop	4942	MA_Regeton_C	4/4	4	98			:
SynLd	Hip Hop	4943	MB_Regeton_C	4/4	4	98			:
SynLd	Hip Hop	4944	MC_Regeton_C	4/4	4	98			:
SynLd	Hip Hop	4945	FA_Regeton_C	4/4	1	98			:
SynLd	Hip Hop	4946	FB_Regeton_C	4/4	1	98			:
SynLd	Hip Hop	4947	FC_Regeton_C	4/4	1	98			:
SynLd	Hip Hop	4948	MA_Rap Lead1	4/4	2	120			:
SynLd	Hip Hop	4949	MA_Rap Lead2	4/4	2	100			:
SynLd	Modern R&B	4950	MB_R&B Disco_N	4/4	2	110			:
SynLd	Modern R&B	4951	MC_R&B Disco_N	4/4	1	110			:
SynLd	Modern R&B	4952	MD_R&B Disco_N	4/4	2	110			:
SynLd	Modern R&B	4953	FA_R&B Disco_N	4/4	1	110			:
SynLd	Modern R&B	4954	FB_R&B Disco	4/4	1	110			:
SynLd	Modern R&B	4955	FC_R&B Disco_N	4/4	2	110			:
SynLd	Modern R&B	4956	MA_R&B Ballad 1_C	4/4	4	113			:
SynLd	Modern R&B	4957	MB_R&B Ballad 1_C	4/4	4	113			:

Main Category	Sub Category	ARP No.	ARP Name	Time Signature	Length	Original Tempo	Accent	Random SFX	Sound Type
SynLd	Modern R&B	4958	MC_R&B Ballad 1_C	4/4	4	113			:
SynLd	Modern R&B	4959	FA_R&B Ballad 1_C	4/4	1	113			:
SynLd	Modern R&B	4960	FB_R&B Ballad 1_C	4/4	1	113			:
SynLd	Modern R&B	4961	FC_R&B Ballad 1_C	4/4	1	113			:
SynLd	Funk	4962	MA_Club Jazz 1_C	4/4	4	125			:
SynLd	Funk	4963	MB_Club Jazz 1_C	4/4	4	125			:
SynLd	Funk	4964	MC_Club Jazz 1_C	4/4	4	125			:
SynLd	Funk	4965	FA_Club Jazz 1_C	4/4	1	125			:
SynLd	Funk	4966	FB_Club Jazz 1_C	4/4	1	125			:
SynLd	Funk	4967	FC_Club Jazz 1_C	4/4	1	125			:
SynLd	Funk	4968	BA_Club Jazz 1_C	4/4	1	125			:
SynLd	Funk	4969	MA_Club Jazz 1_N	4/4	2	125			:
SynLd	Funk	4970	MB_Club Jazz 1_N	4/4	4	125			:
SynLd	Funk	4971	MC_Club Jazz 1_N	4/4	4	125			:
SynLd	Funk	4972	FA_Club Jazz 1	4/4	1	125			:
SynLd	Funk	4973	FB_Club Jazz 1_N	4/4	1	125			:
SynLd	Funk	4974	FC_Club Jazz 1_N	4/4	1	125			:
SynLd	Funk	4975	BA_Club Jazz 1_N	4/4	1	125			:
SynLd	Techno	4976	MA_SynthRiff1-01_N	4/4	4	130			:
SynLd	Techno	4977	MA_SynthRiff1-01	4/4	4	130			:
SynLd	Techno	4978	MA_SynthRiff1-02_N	4/4	2	130			:
SynLd	Techno	4979	MA_SynthRiff1-02	4/4	2	130			:
SynLd	Techno	4980	MA_SynthRiff1-03_N	4/4	4	130			:
SynLd	Techno	4981	MA_SynthRiff1-03	4/4	4	130			:
SynLd	Techno	4982	MA_SynthRiff1-04_N	4/4	2	130			:
SynLd	Techno	4983	MA_SynthRiff1-04	4/4	2	130			:
SynLd	Techno	4984	MA_SynthRiff1-05_N	4/4	2	130			:
SynLd	Techno	4985	MA_SynthRiff1-05	4/4	2	130			:
SynLd	Techno	4986	MA_SynthRiff1-06a	4/4	1	130			:
SynLd	Techno	4987	MA_SynthRiff1-06b	4/4	1	130			:
SynLd	Techno	4988	MA_SynthRiff1-07_N	4/4	4	130			:
SynLd	Techno	4989	MA_SynthRiff1-07	4/4	4	130			:
SynLd	Techno	4990	MA_SynthRiff1-08_N	4/4	2	130			:
SynLd	Techno	4991	MA_SynthRiff1-08	4/4	2	130			:
SynLd	Techno	4992	MA_SynthRiff1-09	4/4	2	130			:
SynLd	Techno	4993	MA_SynthRiff1-10	4/4	2	130			:
SynLd	Techno	4994	MA_SynthRiff1-11	4/4	2	130			:
SynLd	Techno	4995	MA_SynthRiff1-12	4/4	1	130			:
SynLd	Techno	4996	MA_LayerHook1-01_N	4/4	2	130			:
SynLd	Techno	4997	MA_LayerHook1-01	4/4	2	130			:
SynLd	Techno	4998	MA_LayerHook1-02	4/4	4	130			:
SynLd	Techno	4999	MA_LayerHook1-03_N	4/4	4	130			:
SynLd	Techno	5000	MA_LayerHook1-03	4/4	4	130			:
SynLd	Techno	5001	MA_LayerHook1-04_N	4/4	2	130			:
SynLd	Techno	5002	MA_LayerHook1-04	4/4	2	130			:
SynLd	Techno	5003	MA_LayerHook1-05_N	4/4	4	130			:
SynLd	Techno	5004	MA_LayerHook1-05	4/4	4	130			:
SynLd	Techno	5005	MA_LayerHook1-06_N	4/4	2	130			:
SynLd	Techno	5006	MA_LayerHook1-06	4/4	2	130			:
SynLd	Techno	5007	MA_LayerHook1-07_N	4/4	2	130			:
SynLd	Techno	5008	MA_LayerHook1-07	4/4	2	130			:
SynLd	Techno	5009	MA_LayerHook1-08_N	4/4	4	130			:
SynLd	Techno	5010	MA_LayerHook1-08	4/4	4	130			:
SynLd	Techno	5011	MA_LayerHook1-09_N	4/4	2	130			:
SynLd	Techno	5012	MA_LayerHook1-09	4/4	2	130			:
SynLd	Techno	5013	MA_LayerHook1-10	4/4	2	130			:
SynLd	Techno	5014	MA_LayerHook1-11	4/4	2	130			:
SynLd	Techno	5015	MA_LayerHook1-12	4/4	2	130			:
SynLd	Techno	5016	MA_Simple Lead 01	4/4	1	130			:
SynLd	Techno	5017	MA_Simple Lead 02	4/4	1	130			:
SynLd	Techno	5018	MA_Simple Lead 03	4/4	1	130			:
SynLd	Techno	5019	MA_Simple Lead 04	4/4	1	130			:
SynLd	Techno	5020	MA_Simple Lead 05	4/4	1	130			:
SynLd	Techno	5021	MA_Simple Lead 06	4/4	1	130			:
SynLd	Techno	5022	MA_Simple Lead 07	4/4	1	130			:
SynLd	Techno	5023	MA_Simple Lead08_N	4/4	4	130			:
SynLd	Techno	5024	MA_Simple Lead 08	4/4	4	130			:
SynLd	Techno	5025	MA_Simple Lead09_N	4/4	4	130			:
SynLd	Techno	5026	MA_Simple Lead 09	4/4	4	130			:
SynLd	Techno	5027	MA_Simple Lead10_N	4/4	4	130			:
SynLd	Techno	5028	MA_Simple Lead 10	4/4	4	130			:
SynLd	Techno	5029	MA_Alarm Lucky_N	4/4	4	128			:
SynLd	Techno	5030	MA_Switched_N	4/4	1	122			:
SynLd	Techno	5031	MA_Alarma_N	4/4	1	140			:
SynLd	Techno	5032	MA_Unison Sky_N	4/4	4	120			:
SynLd	Techno	5033							

Arpeggio Type List

Main Category	Sub Category	ARP No.	ARP Name	Time Signature	Length	Original Tempo	Accent	Random SFX	Sound Type
SynLd	Techno	5045	FC_Trance 1_N	4/4	8	142			:
SynLd	Techno	5046	BA_Trance 1_N	4/4	1	142			:
SynLd	Techno	5047	MA_Trance 3_C	4/4	2	140			:
SynLd	Techno	5048	MB_Trance 3_C	4/4	2	140			:
SynLd	Techno	5049	MC_Trance 3_C	4/4	3	140			:
SynLd	Techno	5050	FA_Trance 3_C	4/4	2	140			:
SynLd	Techno	5051	FB_Trance 3_N	4/4	2	140			:
SynLd	Techno	5052	FC_Trance 3_C	4/4	4	140			:
SynLd	Techno	5053	BA_Trance 3_C	4/4	1	140			:
SynLd	Techno	5054	MA_Trance 3_N	4/4	2	140			:
SynLd	Techno	5055	MB_Trance 3_N	4/4	2	140			:
SynLd	Techno	5056	MC_Trance 3_N	4/4	3	140			:
SynLd	Techno	5057	FA_Trance 3_N	4/4	2	140			:
SynLd	Techno	5058	FB_Trance 3_N	4/4	2	140			:
SynLd	Techno	5059	FC_Trance 3_N	4/4	4	140			:
SynLd	Techno	5060	BA_Trance 3	4/4	1	140			:
SynLd	Techno	5061	MA_Trance 4_C	4/4	4	130			:
SynLd	Techno	5062	MB_Trance 4_C	4/4	2	130			:
SynLd	Techno	5063	MC_Trance 4_C	4/4	4	130			:
SynLd	Techno	5064	FA_Trance 4_C	4/4	4	130			:
SynLd	Techno	5065	FB_Trance 4_C	4/4	2	130			:
SynLd	Techno	5066	FC_Trance 4_C	4/4	4	130			:
SynLd	Techno	5067	BA_Trance 4_C	4/4	2	130			:
SynLd	Techno	5068	MA_Trance 4_N	4/4	4	130			:
SynLd	Techno	5069	MB_Trance 4_N	4/4	2	130			:
SynLd	Techno	5070	MC_Trance 4_N	4/4	4	130			:
SynLd	Techno	5071	FA_Trance 4_N	4/4	4	130			:
SynLd	Techno	5072	FB_Trance 4_N	4/4	2	130			:
SynLd	Techno	5073	FC_Trance 4_N	4/4	4	130			:
SynLd	Techno	5074	BA_Trance 4_N	4/4	2	130			:
SynLd	Techno	5075	MA_Trance Lead1_N	4/4	8	143			:
SynLd	Techno	5076	MA_Trance Lead2_N	4/4	2	143			:
SynLd	Techno	5077	MA_Trance Lead3_N	4/4	2	143			:
SynLd	Techno	5078	MA_Trance Lead4_N	4/4	1	143			:
SynLd	Techno	5079	MA_Trance Lead5_N	4/4	2	143			:
SynLd	Techno	5080	MA_Psyche Lead1_N	4/4	1	143			:
SynLd	Techno	5081	MA_Psyche Lead2_N	4/4	1	143			:
SynLd	Techno	5082	MA_Psyche Lead3_N	4/4	1	143			:
SynLd	Techno	5083	MA_Psyche Lead4_N	4/4	2	143			:
SynLd	Techno	5084	MA_Psyche Lead5_N	4/4	2	143			:
SynLd	House	5085	MA_Syn Acid 1	4/4	4	120			:
SynLd	House	5086	MA_Syn Acid 2	4/4	4	120			:
SynLd	House	5087	MA_Syn Acid 3	4/4	4	120			:
SynLd	House	5088	MA_SynthRiff2-01_N	4/4	1	135			:
SynLd	House	5089	MA_SynthRiff2-01	4/4	1	135			:
SynLd	House	5090	MA_SynthRiff2-02	4/4	1	140			:
SynLd	House	5091	MA_SynthRiff2-03	4/4	1	130			:
SynLd	House	5092	MA_SynthRiff2-04	4/4	1	130			:
SynLd	House	5093	MA_SynthRiff2-05	4/4	1	130			:
SynLd	House	5094	MA_SynthRiff2-06	4/4	1	130			:
SynLd	House	5095	MA_SynthRiff2-07	4/4	1	130			:
SynLd	House	5096	MA_SynthRiff2-08	4/4	2	130			:
SynLd	House	5097	MA_SynthRiff2-09	4/4	4	130			:
SynLd	House	5098	MA_SynthRiff2-10	4/4	1	130			:
SynLd	House	5099	MA_LayerHook2-01_N	4/4	2	128			:
SynLd	House	5100	MA_LayerHook2-01	4/4	2	128			:
SynLd	House	5101	MA_LayerHook2-02_N	4/4	2	128			:
SynLd	House	5102	MA_LayerHook2-02	4/4	2	128			:
SynLd	House	5103	MA_LayerHook2-03_N	4/4	2	128			:
SynLd	House	5104	MA_LayerHook2-03	4/4	2	128			:
SynLd	House	5105	MA_LayerHook2-04_N	4/4	4	128			:
SynLd	House	5106	MA_LayerHook2-04	4/4	4	128			:
SynLd	House	5107	MA_LayerHook2-05_N	4/4	2	128			:
SynLd	House	5108	MA_LayerHook2-05	4/4	2	128			:
SynLd	House	5109	MA_LayerHook2-06_N	4/4	2	128			:
SynLd	House	5110	MA_LayerHook2-06	4/4	2	128			:
SynLd	House	5111	MA_LayerHook2-07_N	4/4	2	128			:
SynLd	House	5112	MA_LayerHook2-07	4/4	2	128			:
SynLd	House	5113	MA_LayerHook2-08_N	4/4	2	128			:
SynLd	House	5114	MA_LayerHook2-08	4/4	2	128			:
SynLd	House	5115	MA_LayerHook2-09_N	4/4	2	128			:
SynLd	House	5116	MA_LayerHook2-09	4/4	2	128			:
SynLd	House	5117	MA_LayerHook2-10_N	4/4	2	128			:
SynLd	House	5118	MA_LayerHook2-10	4/4	2	128			:
SynLd	House	5119	MA_16th Riff 01_N	4/4	4	130			:
SynLd	House	5120	MA_16th Riff 01	4/4	4	130			:
SynLd	House	5121	MA_16th Riff 02_N	4/4	4	124			:
SynLd	House	5122	MA_16th Riff 02	4/4	4	124			:
SynLd	House	5123	MA_16th Riff 03_N	4/4	2	124			:
SynLd	House	5124	MA_16th Riff 03	4/4	2	124			:
SynLd	House	5125	MA_16th Riff 04_N	4/4	2	124			:
SynLd	House	5126	MA_16th Riff 04	4/4	2	124			:
SynLd	House	5127	MA_16th Riff 05_N	4/4	2	124			:
SynLd	House	5128	MA_16th Riff 05	4/4	2	124			:
SynLd	House	5129	MA_16th Riff 06_N	4/4	2	130			:
SynLd	House	5130	MA_16th Riff 06	4/4	2	130			:
SynLd	House	5131	MA_16th Riff 07_N	4/4	2	124			:

Main Category	Sub Category	ARP No.	ARP Name	Time Signature	Length	Original Tempo	Accent	Random SFX	Sound Type
SynLd	House	5132	MA_16th Riff 07	4/4	2	124			:
SynLd	House	5133	MA_16th Riff 08_N	4/4	4	130			:
SynLd	House	5134	MA_16th Riff 08	4/4	4	130			:
SynLd	House	5135	MA_16th Riff 09_N	4/4	4	130			:
SynLd	House	5136	MA_16th Riff 09	4/4	4	130			:
SynLd	House	5137	MA_16th Riff 10_N	4/4	4	130			:
SynLd	House	5138	MA_16th Riff 10	4/4	4	130			:
SynLd	House	5139	MA_MelodicPluck01_N	4/4	4	130			:
SynLd	House	5140	MA_MelodicPluck01	4/4	4	130			:
SynLd	House	5141	MA_MelodicPluck02_N	4/4	2	130			:
SynLd	House	5142	MA_MelodicPluck02	4/4	2	130			:
SynLd	House	5143	MA_MelodicPluck03_N	4/4	4	130			:
SynLd	House	5144	MA_MelodicPluck03	4/4	4	130			:
SynLd	House	5145	MA_MelodicPluck04_N	4/4	2	130			:
SynLd	House	5146	MA_MelodicPluck04	4/4	2	130			:
SynLd	House	5147	MA_MelodicPluck05_N	4/4	2	130			:
SynLd	House	5148	MA_MelodicPluck05	4/4	2	130			:
SynLd	House	5149	MA_MelodicPluck06_N	4/4	2	140			:
SynLd	House	5150	MA_MelodicPluck06	4/4	2	140			:
SynLd	House	5151	MA_MelodicPluck07_N	4/4	2	130			:
SynLd	House	5152	MA_MelodicPluck07	4/4	2	130			:
SynLd	House	5153	MA_SimpleNt 2-01_N	4/4	4	130			:
SynLd	House	5154	MA_SimpleNt 2-01	4/4	4	130			:
SynLd	House	5155	MA_SimpleNt 2-02_N	4/4	2	130			:
SynLd	House	5156	MA_SimpleNt 2-02	4/4	2	130			:
SynLd	House	5157	MA_SimpleNt 2-03_N	4/4	2	130			:
SynLd	House	5158	MA_SimpleNt 2-03	4/4	2	130			:
SynLd	House	5159	MA_SimpleNt 2-04a	4/4	2	130			:
SynLd	House	5160	MA_SimpleNt 2-04b	4/4	2	130			:
SynLd	House	5161	MA_SimpleNt 2-05_N	4/4	2	130			:
SynLd	House	5162	MA_SimpleNt 2-05	4/4	2	130			:
SynLd	House	5163	MA_SimpleNt 2-06_N	4/4	2	130			:
SynLd	House	5164	MA_SimpleNt 2-06	4/4	2	130			:
SynLd	House	5165	MA_SimpleNt 2-07_N	4/4	2	130			:
SynLd	House	5166	MA_SimpleNt 2-07	4/4	2	130			:
SynLd	House	5167	MA_SimpleNt 2-08a	4/4	2	130			:
SynLd	House	5168	MA_SimpleNt 2-08b	4/4	2	130			:
SynLd	House	5169	MA_SimpleNt 2-09_N	4/4	2	130			:
SynLd	House	5170	MA_SimpleNt 2-09	4/4	2	130			:
SynLd	House	5171	MA_SimpleNt 2-10_N	4/4	2	130			:
SynLd	House	5172	MA_SimpleNt 2-10	4/4	2	130			:
SynLd	House	5173	MA_SyChdrRiff1-1_N	4/4	2	130			:
SynLd	House	5174	MA_SyChdrRiff1-1	4/4	2	130			:
SynLd	House	5175	MA_SyChdrRiff1-2_N	4/4	2	130			:
SynLd	House	5176	MA_SyChdrRiff1-2	4/4	2	130			:
SynLd	House	5177	MA_SyChdrRiff1-3_N	4/4	2	130			:
SynLd	House	5178	MA_SyChdrRiff1-3	4/4	2	130			:
SynLd	House	5179	MA_SynthRiff3-01_N	4/4	4	130			:
SynLd	House	5180	MA_SynthRiff3-02	4/4	4	130			:
SynLd	House	5181	MA_SynthRiff3-03_N	4/4	2	130			:
SynLd	House	5182	MA_SynthRiff3-04_N	4/4	2	130			:
SynLd	House	5183	MA_SynthRiff3-05_N	4/4	2	130			:
SynLd	House	5184	MA_SynthRiff3-06_N	4/4	2	130			:
SynLd	House	5185	MA_SynthRiff3-07_N	4/4	2	147			:
SynLd	House	5186	MA_SynthRiff3-08_N	4/4	2	147			:
SynLd	House	5187	MA_SynthRiff3-09_N	4/4	2	147			:
SynLd	House	5188	MA_SynthRiff3-10_N	4/4	2	147			:
SynLd	House	5189	MA_SynthRiff3-11_N	4/4	4	147			:
SynLd	House	5190	MA_SynthRiff3-12_N	4/4	2	130			:
SynLd	House	5191	MA_SynthRiff3-13_N	4/4	2	130			:
SynLd	House	5192	MA_EmoDM Lead	4/4	4	120			:
SynLd	House	5193	MA_Octopus	4/4	4	150			:
SynLd	House	5194	MA_Skate King_N	4/4	4	133			:
SynLd	D&B	5195	MA_Fun Lead_N	4/4	4	150			:
SynLd	D&B	5196	MA_Big Beat 2_N	4/4	4	145			:
SynLd	D&B	5197	MA_Big Beat 2_N	4/4	8	145			:
SynLd	D&B	5198	MA_Big Beat 2_N	4/4	4	145			:
SynLd	D&B	5199	MA_Big Beat 2_N	4/4	1	145			:
SynLd	D&B	5200	MA_Big Beat 2_N	4/4	1	145			:
SynLd	D&B	5201	MA_Big Beat 2_N	4/4	1	145			:
SynLd	D&B	5202	MA_Big Beat 2_N	4/4	2	145			:
SynLd	Chill	5203	MA_Sunrise Arp_N	4/4	1	103			:
SynLd	Chill	520							

Main Category	Sub Category	ARP No.	ARP Name	Time Signature	Length	Original Tempo	Accent	Random SFX	Sound Type
Pad	Rock	5219	MB_16BeatBasic2_N	4/4	4	77			:
Pad	Rock	5220	MC_16BeatBasic2_N	4/4	4	77			:
Pad	Rock	5221	FA_16BeatBasic2_N	4/4	1	77			:
Pad	Rock	5222	FB_16BeatBasic2_N	4/4	1	77			:
Pad	Rock	5223	FC_16BeatBasic2_N	4/4	1	77			:
Pad	Rock	5224	BA_16BeatBasic2_N	4/4	1	77			:
Pad	Rock	5225	MA_16Beat Rock_C	4/4	4	86			:
Pad	Rock	5226	MB_16Beat Rock_C	4/4	4	86			:
Pad	Rock	5227	MC_16Beat Rock_C	4/4	4	86			:
Pad	Rock	5228	FA_16Beat Rock_C	4/4	1	86			:
Pad	Rock	5229	FB_16Beat Rock_C	4/4	1	86			:
Pad	Rock	5230	FC_16Beat Rock_C	4/4	1	86			:
Pad	Rock	5231	BA_16Beat Rock_C	4/4	1	86			:
Pad	Rock	5232	MA_16Beat Rock_N	4/4	4	86			:
Pad	Rock	5233	MB_16Beat Rock_N	4/4	4	86			:
Pad	Rock	5234	MC_16Beat Rock_N	4/4	4	86			:
Pad	Rock	5235	FA_16Beat Rock_N	4/4	1	86			:
Pad	Rock	5236	FB_16Beat Rock_N	4/4	1	86			:
Pad	Rock	5237	FC_16Beat Rock_N	4/4	1	86			:
Pad	Rock	5238	BA_16Beat Rock_N	4/4	1	86			:
Pad	Pop Rock	5239	MA_16Beat Pop 1_C	4/4	4	103			:
Pad	Pop Rock	5240	MB_16Beat Pop 1_C	4/4	4	103			:
Pad	Pop Rock	5241	MC_16Beat Pop 1_C	4/4	4	103			:
Pad	Pop Rock	5242	FA_16Beat Pop 1_C	4/4	1	103			:
Pad	Pop Rock	5243	FB_16Beat Pop 1_C	4/4	1	103			:
Pad	Pop Rock	5244	FC_16Beat Pop 1_C	4/4	1	103			:
Pad	Pop Rock	5245	BA_16Beat Pop 1_C	4/4	1	103			:
Pad	Pop Rock	5246	MA_16Beat Pop 1_N	4/4	4	103			:
Pad	Pop Rock	5247	MB_16Beat Pop 1_N	4/4	4	103			:
Pad	Pop Rock	5248	MC_16Beat Pop 1_N	4/4	4	103			:
Pad	Pop Rock	5249	FA_16Beat Pop 1_N	4/4	1	103			:
Pad	Pop Rock	5250	FB_16Beat Pop 1_N	4/4	1	103			:
Pad	Pop Rock	5251	FC_16Beat Pop 1_N	4/4	1	103			:
Pad	Pop Rock	5252	BA_16Beat Pop 1_N	4/4	1	103			:
Pad	Pop Rock	5253	MA_16Beat Pop 2_C	4/4	4	94			:
Pad	Pop Rock	5254	MB_16Beat Pop 2_C	4/4	4	94			:
Pad	Pop Rock	5255	MC_16Beat Pop 2_C	4/4	4	94			:
Pad	Pop Rock	5256	FA_16Beat Pop 2_C	4/4	1	94			:
Pad	Pop Rock	5257	FB_16Beat Pop 2_C	4/4	1	94			:
Pad	Pop Rock	5258	FC_16Beat Pop 2_C	4/4	1	94			:
Pad	Pop Rock	5259	BA_16Beat Pop 2_C	4/4	1	94			:
Pad	Pop Rock	5260	MA_16Beat Pop 2_N	4/4	4	94			:
Pad	Pop Rock	5261	MB_16Beat Pop 2_N	4/4	4	94			:
Pad	Pop Rock	5262	MC_16Beat Pop 2_N	4/4	4	94			:
Pad	Pop Rock	5263	FA_16Beat Pop 2_N	4/4	1	94			:
Pad	Pop Rock	5264	FB_16Beat Pop 2_N	4/4	1	94			:
Pad	Pop Rock	5265	FC_16Beat Pop 2_N	4/4	1	94			:
Pad	Pop Rock	5266	BA_16Beat Pop 2_N	4/4	1	94			:
Pad	Pop Rock	5267	MC_Analog Pop	4/4	1	93			:
Pad	Pop Rock	5268	MD_Analog Pop	4/4	1	93			:
Pad	Hip Hop	5269	MA_SynClassic Trap	4/4	4	120			:
Pad	Hip Hop	5270	MA_Trap Hard Keys	4/4	2	107			:
Pad	Modern R&B	5271	MA_Pop Shuffle3_C	4/4	4	80			:
Pad	Modern R&B	5272	MB_Pop Shuffle3_C	4/4	4	80			:
Pad	Modern R&B	5273	MC_Pop Shuffle3_C	4/4	4	80			:
Pad	Modern R&B	5274	FA_Pop Shuffle3_C	4/4	1	80			:
Pad	Modern R&B	5275	FB_Pop Shuffle3_C	4/4	1	80			:
Pad	Modern R&B	5276	FC_Pop Shuffle3_C	4/4	1	80			:
Pad	Modern R&B	5277	BA_Pop Shuffle3_C	4/4	1	80			:
Pad	Modern R&B	5278	MA_Pop Shuffle3_N	4/4	4	80			:
Pad	Modern R&B	5279	MB_Pop Shuffle3_N	4/4	4	80			:
Pad	Modern R&B	5280	MC_Pop Shuffle3_N	4/4	4	80			:
Pad	Modern R&B	5281	FA_Pop Shuffle3_N	4/4	1	80			:
Pad	Modern R&B	5282	FB_Pop Shuffle3_N	4/4	1	80			:
Pad	Modern R&B	5283	FC_Pop Shuffle3_N	4/4	1	80			:
Pad	Modern R&B	5284	BA_Pop Shuffle3_N	4/4	1	80			:
Pad	Modern R&B	5285	MA_Chart R&B_C	4/4	4	130			:
Pad	Modern R&B	5286	MB_Chart R&B_C	4/4	4	130			:
Pad	Modern R&B	5287	MC_Chart R&B_C	4/4	4	130			:
Pad	Modern R&B	5288	FA_Chart R&B_C	4/4	1	130			:
Pad	Modern R&B	5289	FB_Chart R&B_C	4/4	1	130			:
Pad	Modern R&B	5290	FC_Chart R&B_C	4/4	1	130			:
Pad	Modern R&B	5291	BA_Chart R&B_C	4/4	1	130			:
Pad	Modern R&B	5292	EA_Chart R&B_C	4/4	5	130			:
Pad	Modern R&B	5293	EB_Chart R&B_C	4/4	10	130			:
Pad	Modern R&B	5294	MD_Smooth 1	4/4	2	115			:
Pad	Modern R&B	5295	FC_Smooth 1	4/4	2	115			:
Pad	Techno	5296	MC2_Techno 1_N	4/4	8	135			:
Pad	Techno	5297	MA_Cloud View_N	4/4	1	120			:
Pad	House	5298	MA_Baby Jump Keys	4/4	2	120			:
Pad	House	5299	MA_CosmicHeartLead	4/4	2	122			:
Pad	House	5300	MA_Deep N Low Keys	4/4	2	122			:
Pad	House	5301	MA_Play Thing Pad	4/4	2	110			:
Pad	House	5302	MA_ShowTheLights_N	4/4	1	120			:
Pad	D&B	5303	MA_Dubtastic Pad	4/4	2	140			:
Pad	Chill	5304	MA_Science_N	4/4	2	120			:
Pad	General	5305	MA_Cycle1	4/4	3	120			:

Main Category	Sub Category	ARP No.	ARP Name	Time Signature	Length	Original Tempo	Accent	Random SFX	Sound Type
Pad	General	5306	MA_Cycle2	4/4	6	120			:
Pad	General	5307	MA_Cycle3_N	4/4	14	118			:
Pad	General	5308	MA_Ripples_N	4/4	4	82			:
Pad	General	5309	MA_PulsPad	4/4	4	120			:
SynCp	Rock	5310	MA_AlternaRock2_N	4/4	4	100			Syn Comp/Lead
SynCp	Rock	5311	MB_AlternaRock2_N	4/4	4	100			:
SynCp	Rock	5312	MC_AlternaRock2_N	4/4	4	100			:
SynCp	Rock	5313	FA_AlternaRock2	4/4	1	100			:
SynCp	Rock	5314	FB_AlternaRock2_N	4/4	1	100			:
SynCp	Rock	5315	FC_AlternaRock2_N	4/4	1	100			:
SynCp	Rock	5316	BA_AlternaRock2_N	4/4	2	100			:
SynCp	Pop Rock	5317	MA_Syn16 80s 1	4/4	4	120			:
SynCp	Pop Rock	5318	MA_Syn16 80s 2	4/4	4	120			:
SynCp	Pop Rock	5319	MA1_Electro Pop	4/4	1	94			:
SynCp	Pop Rock	5320	MB1_Electro Pop	4/4	1	94			:
SynCp	Pop Rock	5321	MC1_Electro Pop	4/4	1	94			:
SynCp	Pop Rock	5322	MD1_Electro Pop	4/4	1	94			:
SynCp	Pop Rock	5323	MA2_Electro Pop	4/4	1	94			:
SynCp	Pop Rock	5324	MA2_Electro Pop AF1	4/4	1	94			:
SynCp	Pop Rock	5325	MA2_Electro Pop AF2	4/4	4	94			:
SynCp	Pop Rock	5326	MB2_Electro Pop	4/4	1	94			:
SynCp	Pop Rock	5327	MA3_Electro Pop	4/4	1	94			:
SynCp	Pop Rock	5328	MB3_Electro Pop	4/4	4	94			:
SynCp	Pop Rock	5329	MC3_Electro Pop	4/4	1	94			:
SynCp	Pop Rock	5330	MD3_Electro Pop	4/4	1	94			:
SynCp	Pop Rock	5331	ME3_Electro Pop	4/4	1	94			:
SynCp	Pop Rock	5332	MA_Voxdance	4/4	1	90			:
SynCp	Pop Rock	5333	MA_Voxdance AF2	4/4	1	90			:
SynCp	Pop Rock	5334	MB_Voxdance	4/4	1	90			:
SynCp	Pop Rock	5335	MB_Voxdance AF1	4/4	1	90			:
SynCp	Pop Rock	5336	MA_Jumping	4/4	4	90			:
SynCp	Pop Rock	5337	MB_Jumping	4/4	4	90			:
SynCp	Pop Rock	5338	MB_Jumping AF1	4/4	1	90			:
SynCp	Pop Rock	5339	MB_Jumping AF2	4/4	4	90			:
SynCp	Pop Rock	5340	MA_80'sSynthRock_C	4/4	4	96			:
SynCp	Pop Rock	5341	MB_80'sSynthRock_C	4/4	4	96			:
SynCp	Pop Rock	5342	MC_80'sSynthRock_C	4/4	8	96			:
SynCp	Pop Rock	5343	FA_80'sSynthRock_C	4/4	1	96			:
SynCp	Pop Rock	5344	FB_80'sSynthRock_C	4/4	1	96			:
SynCp	Pop Rock	5345	FC_80'sSynthRock_C	4/4	1	96			:
SynCp	Pop Rock	5346	BA_80'sSynthRock_C	4/4	1	96			:
SynCp	Pop Rock	5347	EA_80'sSynthRock_C	4/4	3	96			:
SynCp	Hip Hop	5348	MA_Trap Hard Arp	4/4	2	107			:
SynCp	Hip Hop	5349	MA_2B24U	4/4	2	75			:
SynCp	Hip Hop	5350	MB_2B24U	4/4	2	75			:
SynCp	Hip Hop	5351	MC_2B24U	4/4	2	75			:
SynCp	Hip Hop	5352	MD_2B24U	4/4	2	75			:
SynCp	Hip Hop	5353	MA_PepRally	4/4	4	75			:
SynCp	Hip Hop	5354	MB_PepRally	4/4	4	75			:
SynCp	Hip Hop	5355	MC_Hip Hop 3_N	4/4	2	104			:
SynCp	Hip Hop	5356	MD_Hip Hop 3	4/4	2	104			:
SynCp	Hip Hop	5357	FB_Hip Hop 3	4/4	1	104			:
SynCp	Hip Hop	5358	MA_Hip Rock 2_C	4/4	4	132			:
SynCp	Hip Hop	5359	MB_Hip Rock 2_C	4/4	4	132			:
SynCp	Hip Hop	5360	MC_Hip Rock 2_C	4/4	4	132			:
SynCp	Hip Hop	5361	FA_Hip Rock 2_C	4/4	1	132			:
SynCp	Hip Hop	5362	FB_Hip Rock 2_C	4/4	1	132			:
SynCp	Hip Hop	5363	FC_Hip Rock 2_C	4/4	1	132			:
SynCp	Hip Hop	5364	MA_Dancehall_C	4/4	4	103			:
SynCp	Hip Hop	5365	MB_Dancehall_C	4/4	4	103			:
SynCp	Hip Hop	5366	MD_Dancehall_C	4/4	4	103			:
SynCp	Hip Hop	5367	FA_Dancehall_C	4/4	1	103			:
SynCp	Hip Hop	5368	FB_Dancehall_C	4/4	1	103			:
SynCp	Hip Hop	5369	FD_Dancehall_C	4/4	1	103			:
SynCp	Hip Hop	5370	BA_Dancehall_C	4/4	1	103			:
SynCp	Hip Hop	5371	EA_Dancehall_C	4/4	3	103			:
SynCp	Hip Hop	5372	MA_Funky Chop	4/4	1	120			:
SynCp	Modern R&B	5373	MA_SynChord Sync 1	4/4	4	85			:
SynCp	Modern R&B	5374	MA_SynChord Sync 2	4/4	4	90			:
SynCp	Modern R&B	5375	MA_SynChord Sync 3	4/4	4	95			:
SynCp	Modern R&B	5376	MA_SynChord Sync 4	4/4	4	100			:
SynCp	Modern R&B	5377	MA_SynChord Sync 5	4/4	4	120			:
SynCp	Modern R&B	5378	MB_R&B Disco_N	4/4	2	110			:
SynCp	Modern R&B	5379	MC_R&B Disco_N	4/4	2	110			:
SynCp	Modern R&B	5380	MA_Chart R&B_C	4/4	4	130			:
SynCp	Modern R&B	5381	MB_Chart R&B_C	4/4	4	130			:
SynCp	Modern R&B	5382	MC_Chart R&B_C	4/4	4	130</			

Main Category	Sub Category	ARP No.	ARP Name	Time Signature	Length	Original Tempo	Accent	Random SFX	Sound Type
SynCp	Techno	5393	MA_TranceSyArp02	4 / 4	1	130			:
SynCp	Techno	5394	MA_TranceSyArp03_N	4 / 4	4	130			:
SynCp	Techno	5395	MA_TranceSyArp03	4 / 4	4	130			:
SynCp	Techno	5396	MA_TranceSyArp04_N	4 / 4	4	130			:
SynCp	Techno	5397	MA_TranceSyArp04	4 / 4	4	130			:
SynCp	Techno	5398	MA_TranceSyArp05_N	4 / 4	4	130			:
SynCp	Techno	5399	MA_TranceSyArp05	4 / 4	4	130			:
SynCp	Techno	5400	MA_TranceSyArp06	4 / 4	1	130			:
SynCp	Techno	5401	MA_TranceSyArp07	4 / 4	1	130			:
SynCp	Techno	5402	MA_TranceSyArp08	4 / 4	1	130			:
SynCp	Techno	5403	MA_TranceSyArp09	4 / 4	1	130			:
SynCp	Techno	5404	MA_TranceSyArp10_N	4 / 4	1	135			:
SynCp	Techno	5405	MA_TranceSyArp11_N	4 / 4	1	130			:
SynCp	Techno	5406	MA_TranceSyArp12_N	4 / 4	1	130			:
SynCp	Techno	5407	MA_TranceSyArp13_N	4 / 4	1	130			:
SynCp	Techno	5408	MA_TranceSyArp14_N	4 / 4	1	130			:
SynCp	Techno	5409	MA_TranceSyArp15	4 / 4	1	130			:
SynCp	Techno	5410	MA_TranceSyArp16	4 / 4	1	130			:
SynCp	Techno	5411	MA_TranceSyArp17	4 / 4	1	130			:
SynCp	Techno	5412	MA_TranceSyArp18	4 / 4	1	130			:
SynCp	Techno	5413	MA_TranceSyArp19	4 / 4	1	130			:
SynCp	Techno	5414	MA_TranceSyArp20	4 / 4	1	130			:
SynCp	Techno	5415	MA_SynthRHM4-01	4 / 4	2	128			:
SynCp	Techno	5416	MA_16thPattern01	4 / 4	1	130			:
SynCp	Techno	5417	MA_16thPattern02	4 / 4	2	130			:
SynCp	Techno	5418	MA_16thPattern03_N	4 / 4	4	130			:
SynCp	Techno	5419	MA_16thPattern04_N	4 / 4	4	130			:
SynCp	Techno	5420	MA_16thPattern05_N	4 / 4	2	130			:
SynCp	Techno	5421	MA_Feelingz	4 / 4	1	90			:
SynCp	Techno	5422	MA_Bangelis_N	4 / 4	1	120			:
SynCp	Techno	5423	MA1_Trance2_C	4 / 4	8	135			:
SynCp	Techno	5424	MB1_Trance2_C	4 / 4	8	135			:
SynCp	Techno	5425	MC1_Trance2_C	4 / 4	8	135			:
SynCp	Techno	5426	FA1_Trance2_C	4 / 4	1	135			:
SynCp	Techno	5427	FB1_Trance2_C	4 / 4	8	135			:
SynCp	Techno	5428	FC1_Trance2_C	4 / 4	1	135			:
SynCp	Techno	5429	BA1_Trance2_C	4 / 4	1	135			:
SynCp	Techno	5430	MA2_Trance2_C	4 / 4	8	135			:
SynCp	Techno	5431	MB2_Trance2_C	4 / 4	8	135			:
SynCp	Techno	5432	MC2_Trance2_C	4 / 4	8	135			:
SynCp	Techno	5433	FA2_Trance2_C	4 / 4	1	135			:
SynCp	Techno	5434	FB2_Trance2_C	4 / 4	8	135			:
SynCp	Techno	5435	FC2_Trance2_C	4 / 4	1	135			:
SynCp	Techno	5436	BA2_Trance2_C	4 / 4	1	135			:
SynCp	Techno	5437	MA1_Trance2_N	4 / 4	8	135			:
SynCp	Techno	5438	MB1_Trance2_N	4 / 4	8	135			:
SynCp	Techno	5439	MC1_Trance2_N	4 / 4	8	135			:
SynCp	Techno	5440	FA1_Trance2_N	4 / 4	1	135			:
SynCp	Techno	5441	FB1_Trance2	4 / 4	8	135			:
SynCp	Techno	5442	BA1_Trance2_N	4 / 4	1	135			:
SynCp	Techno	5443	MA2_Trance2_N	4 / 4	8	135			:
SynCp	Techno	5444	MB2_Trance2_N	4 / 4	8	135			:
SynCp	Techno	5445	MC2_Trance2_N	4 / 4	8	135			:
SynCp	Techno	5446	FA2_Trance2_N	4 / 4	1	135			:
SynCp	Techno	5447	FB2_Trance2_N	4 / 4	8	135			:
SynCp	Techno	5448	FC2_Trance2	4 / 4	1	135			:
SynCp	Techno	5449	BA2_Trance2_N	4 / 4	1	135			:
SynCp	Techno	5450	MA_Trance3_C	4 / 4	2	140			:
SynCp	Techno	5451	MB_Trance3_C	4 / 4	2	140			:
SynCp	Techno	5452	MC_Trance3_C	4 / 4	3	140			:
SynCp	Techno	5453	FA_Trance3_C	4 / 4	2	140			:
SynCp	Techno	5454	FB_Trance3_C	4 / 4	2	140			:
SynCp	Techno	5455	FC_Trance3_C	4 / 4	4	140			:
SynCp	Techno	5456	BA_Trance3_C	4 / 4	1	140			:
SynCp	Techno	5457	MA_Trance3_N	4 / 4	2	140			:
SynCp	Techno	5458	MB_Trance3_N	4 / 4	2	140			:
SynCp	Techno	5459	MC_Trance3_N	4 / 4	3	140			:
SynCp	Techno	5460	FA_Trance3_N	4 / 4	2	140			:
SynCp	Techno	5461	FB_Trance3_N	4 / 4	2	140			:
SynCp	Techno	5462	FC_Trance3_N	4 / 4	4	140			:
SynCp	Techno	5463	BA_Trance3_N	4 / 4	1	140			:
SynCp	Techno	5464	MB1_Trance5	4 / 4	1	140			:
SynCp	Techno	5465	MA2_Trance5	4 / 4	4	140			:
SynCp	Techno	5466	MD2_Trance5	4 / 4	4	140			:
SynCp	Techno	5467	IA3_Trance5	4 / 4	1	140			:
SynCp	Techno	5468	FC3_Trance5	4 / 4	1	140			:
SynCp	Techno	5469	MB4_Trance5	4 / 4	4	140			:
SynCp	Techno	5470	FA4_Trance5	4 / 4	4	140			:
SynCp	Techno	5471	FA5_Trance5	4 / 4	4	140			:
SynCp	Techno	5472	FC5_Trance5	4 / 4	1	140			:
SynCp	Techno	5473	MC6_Trance5	4 / 4	4	140			:
SynCp	Techno	5474	MA_PsycheSeq1_N	4 / 4	4	140			:
SynCp	Techno	5475	MA_PsycheSeq2_N	4 / 4	1	140			:
SynCp	Techno	5476	MA_PsycheSeq3_N	4 / 4	2	140			:
SynCp	Techno	5477	MA_PsycheSeq4_N	4 / 4	4	140			:
SynCp	Techno	5478	MA_PsycheSeq5_N	4 / 4	6	140			:
SynCp	Techno	5479	MA_TrancePhras1	4 / 4	1	130			:

Main Category	Sub Category	ARP No.	ARP Name	Time Signature	Length	Original Tempo	Accent	Random SFX	Sound Type
SynCp	Techno	5480	MA_TrancePhras2	4 / 4	1	130			:
SynCp	Techno	5481	MA_TrancePhras3	4 / 4	1	130			:
SynCp	Techno	5482	MA_TrancePhras4	4 / 4	1	130			:
SynCp	Techno	5483	MA_TrancePhras5	4 / 4	1	130			:
SynCp	Techno	5484	MA_TrancePhras6	4 / 4	1	130			:
SynCp	Techno	5485	MA_TrancePhras7	4 / 4	1	130			:
SynCp	Techno	5486	MA_TrancePhras8	4 / 4	2	145			:
SynCp	Techno	5487	MA_TrancePhras9	4 / 4	1	145			:
SynCp	Techno	5488	MA_TrancePhrs10	4 / 4	2	145			:
SynCp	Techno	5489	MA_TrancePhrs11	4 / 4	2	145			:
SynCp	Techno	5490	MA_TrancePhrs12	4 / 4	2	145			:
SynCp	Techno	5491	MA_TrancePhrs13	4 / 4	2	145			:
SynCp	Techno	5492	MA_TrancePhrs14	4 / 4	1	145			:
SynCp	Techno	5493	MA_TrancePhrs15	4 / 4	1	145			:
SynCp	Techno	5494	MA_PsychePhras1	4 / 4	1	143			:
SynCp	Techno	5495	MA_PsychePhras2	4 / 4	1	143			:
SynCp	Techno	5496	MA_PsychePhras3_N	4 / 4	2	143			:
SynCp	Techno	5497	MA_PsychePhras4_N	4 / 4	2	143			:
SynCp	Techno	5498	MA_PsychePhras5_N	4 / 4	2	143			:
SynCp	Techno	5499	MA_HyperTrance1_N	4 / 4	1	143			:
SynCp	Techno	5500	MA_HyperTrance2_N	4 / 4	2	143			:
SynCp	Techno	5501	MA_HyperTrance3_N	4 / 4	1	143			:
SynCp	Techno	5502	MA_HyperTrance4_N	4 / 4	1	143			:
SynCp	Techno	5503	MA_HyperTrance5_N	4 / 4	1	143			:
SynCp	Techno	5504	MA1_TranceVision	4 / 4	1	134			:
SynCp	Techno	5505	MB1_TranceVision	4 / 4	1	134			:
SynCp	Techno	5506	MC1_TranceVision	4 / 4	1	134			:
SynCp	Techno	5507	MD1_TranceVision	4 / 4	1	134			:
SynCp	Techno	5508	ME1_TranceVision	4 / 4	1	134			:
SynCp	Techno	5509	MA2_TranceVision	4 / 4	1	134			:
SynCp	Techno	5510	MA2_TrnceVision AF2	4 / 4	1	134			:
SynCp	Techno	5511	MA2_TrmVision AF1&2	4 / 4	1	134			:
SynCp	Techno	5512	MB2_TranceVision	4 / 4	1	134			:
SynCp	Techno	5513	MB2_TrmceVision AF1	4 / 4	1	134			:
SynCp	Techno	5514	MB2_TrmceVision AF2	4 / 4	4	134			:
SynCp	Techno	5515	MB2_TrmVision AF1&2	4 / 4	4	134			:
SynCp	Techno	5516	MA1_DreamTrance	4 / 4	1	140			:
SynCp	Techno	5517	MA1_DreamTrance AF1	4 / 4	1	140			:
SynCp	Techno	5518	MB1_DreamTrance	4 / 4	1	140			:
SynCp	Techno	5519	MC1_DreamTrance	4 / 4	1	140			:
SynCp	Techno	5520	MC1_DreamTrance AF1	4 / 4	1	140			:
SynCp	Techno	5521	MC1_DreamTrance AF2	4 / 4	1	140			:
SynCp	Techno	5522	MC1_DreamTrnc AF1&2	4 / 4	1	140			:
SynCp	Techno	5523	MA1_Electrix	4 / 4	1	119			:
SynCp	Techno	5524	MA1_Electrix AF1	4 / 4	1	119			:
SynCp	Techno	5525	MB1_Electrix	4 / 4	1	119			:
SynCp	Techno	5526	MA2_Electrix	4 / 4	1	119			:
SynCp	Techno	5527	MB2_Electrix	4 / 4	1	119			:
SynCp	Techno	5528	MA1_Cool Breakz	4 / 4	1	116			:
SynCp	Techno	5529	MA1_Cool Breakz AF1	4 / 4	1	116			:
SynCp	Techno	5530	MA1_Cool Breakz AF2	4 / 4	1	116			:
SynCp	Techno	5531	MB1_Cool Breakz	4 / 4	1	116			:
SynCp	Techno	5532	MA2_Cool Breakz	4 / 4	1	116			:
SynCp	Techno	5533	MA1_Synthlines	4 / 4	1	124			:
SynCp	Techno	5534	MA1_Synthlines AF1	4 / 4	1	124			:
SynCp	Techno	5535	MB1_Synthlines	4 / 4	1	124			:
SynCp	Techno	5536	MB1_Synthlines AF1	4 / 4	1	124			:
SynCp	Techno	5537	MB1_Synthlines AF2	4 / 4	1	124			:
SynCp	Techno	5538	MB1_Synthline AF1&2	4 / 4	1	124			:
SynCp	Techno	5539	MC1_Synthlines	4 / 4	1	124			:
SynCp	Techno	5540	MD1_Synthlines	4 / 4	1	124			:
SynCp	Techno	5541	ME1_Synthlines	4 / 4	4	124			:
SynCp	Techno	5542	MA2_Synthlines	4 / 4	1	124			:
SynCp	Techno	5543	MB2_Synthlines	4 / 4	1	124			:
SynCp	Techno	5544	MC2_Synthlines	4 / 4	1	124			:
SynCp	Techno	5545	MD2_Synthlines	4 / 4	1	124			:
SynCp	Techno	5546	MA3_Synthlines	4 / 4	1	124			:
SynCp	Techno	5547	MB3_Synthlines	4 / 4	1	124			:
SynCp	Techno	5548	MC3_Synthlines	4 / 4	1	124			:
SynCp	Techno	5549	MD3_Synthlines	4 / 4	1	124			:
SynCp	Techno	5550	MA1_Acid Breaks	4 / 4	1	98			:
SynCp	Techno	5551	MB1_Acid Breaks	4 / 4	1	98			:
SynCp	Techno	5552	MC1_Acid Breaks	4 / 4	1	98			:

Main Category	Sub Category	ARP No.	ARP Name	Time Signature	Length	Original Tempo	Accent	Random SFX	Sound Type
SynCp	Techno	5567	MA_TeknoPhrs1 /2_C	4 / 4	1	130			:
SynCp	Techno	5568	MA_TeknoPhrs1 /3_C	4 / 4	1	130			:
SynCp	Techno	5569	MA_TeknoPhrs1 /4_C	4 / 4	1	130			:
SynCp	Techno	5570	MA_TeknoPhrs1 /5_C	4 / 4	1	110			:
SynCp	Techno	5571	MA_TeknoPhrs1 /6_C	4 / 4	1	100			:
SynCp	Techno	5572	MA_TeknoPhras2 /1	4 / 4	2	120			:
SynCp	Techno	5573	MA_TeknoPhras2 /2	4 / 4	2	120			:
SynCp	Techno	5574	MA_TeknoPhras2 /3	4 / 4	2	120			:
SynCp	Techno	5575	MA_TeknoAttack1_N	4 / 4	2	143			:
SynCp	Techno	5576	MA_TeknoAttack2_N	4 / 4	1	143			:
SynCp	Techno	5577	MA_TeknoAttack3_N	4 / 4	1	143			:
SynCp	Techno	5578	MA_TeknoAttack4_N	4 / 4	1	143			:
SynCp	Techno	5579	MA_TeknoAttack5_N	4 / 4	1	143			:
SynCp	Techno	5580	MA_Acid A1	4 / 4	2	127			:
SynCp	Techno	5581	MA_Acid A2	4 / 4	2	127			:
SynCp	Techno	5582	MA_Acid A2 AF1	4 / 4	2	90			:
SynCp	Techno	5583	MA_Acid A3	4 / 4	2	127			:
SynCp	Techno	5584	MA_Acid A3 AF1	4 / 4	2	90			:
SynCp	Techno	5585	MA_Acid A4	4 / 4	2	127			:
SynCp	Techno	5586	MA_Acid A5	4 / 4	2	127			:
SynCp	Techno	5587	MA_Acid A6	4 / 4	2	127			:
SynCp	Techno	5588	MA_Acid A6 AF1	4 / 4	2	127			:
SynCp	Techno	5589	MA_Acid A6 AF2	4 / 4	2	127			:
SynCp	Techno	5590	MA_Acid B1	4 / 4	2	127			:
SynCp	Techno	5591	MA_Acid B2	4 / 4	2	127			:
SynCp	Techno	5592	MA_Acid B3	4 / 4	2	127			:
SynCp	Techno	5593	MA_Acid B4	4 / 4	2	127			:
SynCp	Techno	5594	MA_Acid B5	4 / 4	2	127			:
SynCp	Techno	5595	MA_Acid B6	4 / 4	2	127			:
SynCp	Techno	5596	MA_Acid C1	4 / 4	2	127			:
SynCp	Techno	5597	MA_Acid C2	4 / 4	2	127			:
SynCp	Techno	5598	MA_Acid C3	4 / 4	2	127			:
SynCp	Techno	5599	MA_Acid C4	4 / 4	2	127			:
SynCp	Techno	5600	MA_Acid C5	4 / 4	2	127			:
SynCp	Techno	5601	MA_Acid C6	4 / 4	2	127			:
SynCp	Techno	5602	MA_Electro1	4 / 4	1	130			:
SynCp	Techno	5603	MA_Electro2	4 / 4	1	130			:
SynCp	Techno	5604	MA_Electro3	4 / 4	1	130			:
SynCp	Techno	5605	MA_Electro3 AF2	4 / 4	1	123			:
SynCp	Techno	5606	MA_Electro4	4 / 4	1	130			:
SynCp	Techno	5607	MA_Electro5	4 / 4	1	130			:
SynCp	Techno	5608	MA_Electro6	4 / 4	1	130			:
SynCp	Techno	5609	MA_Electro7	4 / 4	1	130			:
SynCp	Techno	5610	MA_Electro8	4 / 4	1	130			:
SynCp	Techno	5611	MA_Electro9	4 / 4	1	130			:
SynCp	Techno	5612	MA_Electro10	4 / 4	1	130			:
SynCp	Techno	5613	MA_Electro10 AF2	4 / 4	1	123			:
SynCp	Techno	5614	MA_Electro11	4 / 4	1	130			:
SynCp	Techno	5615	MA_Electro12	4 / 4	1	130			:
SynCp	Techno	5616	MA_Electro13	4 / 4	1	130			:
SynCp	Techno	5617	MA_Electro14	4 / 4	1	130			:
SynCp	Techno	5618	MA_CompBass1	4 / 4	1	130			:
SynCp	Techno	5619	MA_CompBass2	4 / 4	1	130			:
SynCp	Techno	5620	MA_CompBass2 AF2	4 / 4	8	134			:
SynCp	Techno	5621	MA_CompBass3	4 / 4	1	130			:
SynCp	Techno	5622	MA_CompBass4	4 / 4	1	130			:
SynCp	Techno	5623	MA_Digi Seq1_N	4 / 4	2	106			:
SynCp	Techno	5624	MA_Digi Seq2_N	4 / 4	2	106			:
SynCp	Techno	5625	MA_Digi Seq3_N	4 / 4	2	106			:
SynCp	Techno	5626	MA_Digi Seq4_N	4 / 4	1	106			:
SynCp	Techno	5627	MA_Digi Seq5_N	4 / 4	1	106			:
SynCp	Techno	5628	MA_DigySeq1_N	4 / 4	4	135			:
SynCp	Techno	5629	MA_DigySeq2_N	4 / 4	2	135			:
SynCp	Techno	5630	MA_DigySeq3_N	4 / 4	2	135			:
SynCp	Techno	5631	MA_DigySeq4_N	4 / 4	2	135			:
SynCp	Techno	5632	MA_DigySeq5_N	4 / 4	1	135			:
SynCp	Techno	5633	MA_Seq S&H1	4 / 4	4	120			:
SynCp	Techno	5634	MA_Seq S&H2	4 / 4	4	120			:
SynCp	Techno	5635	MA_Poly Arp1	4 / 4	1	120			:
SynCp	Techno	5636	MA_Poly Arp2	4 / 4	1	120			:
SynCp	Techno	5637	MA_Boiler1	4 / 4	1	120			:
SynCp	Techno	5638	MA_Boiler2	4 / 4	1	120			:
SynCp	Techno	5639	MA_Boiler3	4 / 4	1	120			:
SynCp	Techno	5640	MA_Boiler4	4 / 4	1	110			:
SynCp	Techno	5641	MA_Bees1	4 / 4	1	118			:
SynCp	Techno	5642	MA_Bees2	4 / 4	1	118			:
SynCp	Techno	5643	MA_Bees3	4 / 4	1	118			:
SynCp	Techno	5644	MA_Syncopa1	4 / 4	2	120			:
SynCp	Techno	5645	MA_Tek Echo1	4 / 4	2	120			:
SynCp	Techno	5646	MA_Super Arp	4 / 4	2	120			:
SynCp	Techno	5647	MA_Space Arp	4 / 4	2	120			:
SynCp	Techno	5648	MA_Step Line	4 / 4	1	120			:
SynCp	Techno	5649	MA_Acid Line	4 / 4	1	120			:
SynCp	Techno	5650	MA_Ana Seq	4 / 4	1	120			:
SynCp	Techno	5651	MA_Ascorbic	4 / 4	1	150			:
SynCp	Techno	5652	MA_Beeperz	4 / 4	2	104			:
SynCp	Techno	5653	MA_Doves	4 / 4	1	150			:

Main Category	Sub Category	ARP No.	ARP Name	Time Signature	Length	Original Tempo	Accent	Random SFX	Sound Type
SynCp	Techno	5654	MA_Europluk	4 / 4	1	105			:
SynCp	Techno	5655	MA_Hardcore	4 / 4	3	150			:
SynCp	Techno	5656	MA_Harmo	4 / 4	1	150			:
SynCp	Techno	5657	MA_Lamb	4 / 4	1	125			:
SynCp	Techno	5658	MA_Ocean	4 / 4	1	120			:
SynCp	Techno	5659	MA_Orbit	4 / 4	1	140			:
SynCp	Techno	5660	MA_Pitzy	4 / 4	1	105			:
SynCp	Techno	5661	MA_Planet	4 / 4	1	120			:
SynCp	Techno	5662	MA_Poly Dance	4 / 4	1	120			:
SynCp	Techno	5663	MA_Popcorn	4 / 4	1	120			:
SynCp	Techno	5664	MA_Puls Line	4 / 4	2	120			:
SynCp	Techno	5665	MA_Simple	4 / 4	2	150			:
SynCp	Techno	5666	MA_Split Arp	4 / 4	1	120			:
SynCp	Techno	5667	MA_Step Seq	4 / 4	1	120			:
SynCp	Techno	5668	MA_SyncopaEcho	4 / 4	2	120			:
SynCp	Techno	5669	MA_Tek Bubble	4 / 4	1	128			:
SynCp	Techno	5670	MA_Thips	4 / 4	1	100			:
SynCp	Techno	5671	MA_Waggie	4 / 4	1	140			:
SynCp	Techno	5672	MA_TranceRtm1	4 / 4	4	135			:
SynCp	Techno	5673	MA_TranceRtm2	4 / 4	4	140			:
SynCp	Techno	5674	MA_TranceRtm3	4 / 4	4	140			:
SynCp	Techno	5675	MA_Trance Slab	4 / 4	2	140			:
SynCp	Techno	5676	MA_T-Line Chd	4 / 4	4	140			:
SynCp	Techno	5677	MA_Syncopa2	4 / 4	2	120			:
SynCp	Techno	5678	MA_Tek Echo2	4 / 4	2	120			:
SynCp	Techno	5679	MA_Fugue	4 / 4	2	120			:
SynCp	Techno	5680	MA_Rave Swp	4 / 4	4	135			:
SynCp	Techno	5681	MA_Rosync	4 / 4	1	120			:
SynCp	Techno	5682	MA_Synclavk	4 / 4	2	140			:
SynCp	Techno	5683	MA_HiFive	4 / 4	1	118			:
SynCp	House	5684	MA_SynRiff Elec 1	4 / 4	4	120			:
SynCp	House	5685	MA_SynRiff Elec 2	4 / 4	4	120			:
SynCp	House	5686	MA_SynRiff Elec 3	4 / 4	4	120			:
SynCp	House	5687	MA_SynChord8th01_N	4 / 4	1	130			:
SynCp	House	5688	MA_SynChord8th01	4 / 4	1	130			:
SynCp	House	5689	MA_SynChord8th02_N	4 / 4	1	130			:
SynCp	House	5690	MA_SynChord8th02	4 / 4	1	130			:
SynCp	House	5691	MA_SynChord8th03	4 / 4	1	130			:
SynCp	House	5692	MA_SynChord8th04	4 / 4	2	130			:
SynCp	House	5693	MA_SynChord8th05	4 / 4	4	120			:
SynCp	House	5694	MA_SynChord8th06	4 / 4	1	130			:
SynCp	House	5695	MA_SynChord8th07	4 / 4	1	130			:
SynCp	House	5696	MA_SynChord8th08	4 / 4	2	130			:
SynCp	House	5697	MA_SynChord8th09	4 / 4	2	132			:
SynCp	House	5698	MA_SynChord8th10	4 / 4	2	130			:
SynCp	House	5699	MA_SynChord8th11	4 / 4	2	130			:
SynCp	House	5700	MA_SynChord8th12_N	4 / 4	2	130			:
SynCp	House	5701	MA_SynChord8th12	4 / 4	2	130			:
SynCp	House	5702	MA_SynChord8th13_N	4 / 4	2	130			:
SynCp	House	5703	MA_SynChord8th13	4 / 4	2	130			:
SynCp	House	5704	MA_ClassArp1-01_N	4 / 4	2	128			:
SynCp	House	5705	MA_ClassArp1-02_N	4 / 4	2	128			:
SynCp	House	5706	MA_ClassArp1-03_N	4 / 4	2	128			:
SynCp	House	5707	MA_ClassArp1-04_N	4 / 4	2	128			:
SynCp	House	5708	MA_ClassArp1-05_N	4 / 4	2	128			:
SynCp	House	5709	MA_ClassArp1-06_N	4 / 4	8	128			:
SynCp	House	5710	MA_ClassArp1-07	4 / 4	2	128			:
SynCp	House	5711	MA_ClassArp1-08_N	4 / 4	2	128			:
SynCp	House	5712	MA_ClassArp1-09_N	4 / 4	2	128			:
SynCp	House	5713	MA_ClassArp1-10_N	4 / 4	2	128			:
SynCp	House	5714	MA_SynthRiff5-01_N	4 / 4	2	128			:
SynCp	House	5715	MA_SynthRiff5-01	4 / 4	2	128			:
SynCp	House	5716	MA_SynthRiff5-02_N	4 / 4	4	128			:
SynCp	House	5717	MA_SynthRiff5-02	4 / 4	4	128			:
SynCp	House	5718	MA_SynthRiff5-03_N	4 / 4	4	128			:
SynCp	House	5719	MA_SynthRiff5-03	4 / 4	4	128			:
SynCp	House	5720	MA_SynthRiff5-04_N	4 / 4	4	128			:
SynCp	House	5721	MA_SynthRiff5-04	4 / 4	4	128			:
SynCp	House	5722	MA_SynthRiff5-05_N	4 / 4	4	128			:
SynCp	House	5723	MA_SynthRiff5-05	4 / 4	4	128			:
SynCp	House	5724	MA_SynthRiff5-06_N	4 / 4	4	128			:
SynCp	House	5725	MA_SynthRiff5-06	4 / 4	4	128			:
SynCp	House	5726	MA_SynthRiff5-07_N	4 / 4	4	128			:
SynCp	House	5727	MA_SynthRiff5-07</						

Arpeggio Type List

Main Category	Sub Category	ARP No.	ARP Name	Time Signature	Length	Original Tempo	Accent	Random SFX	Sound Type
SynCp	House	5741	MA_Synth Chord01	4/4	2	128			:
SynCp	House	5742	MA_Synth Chord02_N	4/4	2	128			:
SynCp	House	5743	MA_Synth Chord02	4/4	2	128			:
SynCp	House	5744	MA_Synth Chord03_N	4/4	4	128			:
SynCp	House	5745	MA_Synth Chord03	4/4	4	128			:
SynCp	House	5746	MA_Synth Chord04_N	4/4	4	128			:
SynCp	House	5747	MA_Synth Chord04	4/4	4	128			:
SynCp	House	5748	MA_Synth Chord05_N	4/4	2	128			:
SynCp	House	5749	MA_Synth Chord05	4/4	2	128			:
SynCp	House	5750	MA_Synth Chord06	4/4	2	128			:
SynCp	House	5751	MA_Synth Chord07_N	4/4	4	128			:
SynCp	House	5752	MA_Synth Chord07	4/4	4	128			:
SynCp	House	5753	MA_Synth Chord08_N	4/4	4	150			:
SynCp	House	5754	MA_Synth Chord08	4/4	4	150			:
SynCp	House	5755	MA_Synth Chord09_N	4/4	4	128			:
SynCp	House	5756	MA_Synth Chord09	4/4	4	128			:
SynCp	House	5757	MA_Synth Chord10_N	4/4	4	128			:
SynCp	House	5758	MA_Synth Chord10	4/4	4	128			:
SynCp	House	5759	MA_SynTriplet01_N	4/4	2	128			:
SynCp	House	5760	MA_SynTriplet01	4/4	2	128			:
SynCp	House	5761	MA_SynTriplet02_N	4/4	2	128			:
SynCp	House	5762	MA_SynTriplet03_N	4/4	4	128			:
SynCp	House	5763	MA_SynTriplet04_N	4/4	2	128			:
SynCp	House	5764	MA_SynTriplet04	4/4	2	128			:
SynCp	House	5765	MA_SynTriplet05_N	4/4	2	128			:
SynCp	House	5766	MA_SynTriplet05	4/4	2	128			:
SynCp	House	5767	MA_SynTriplet06	4/4	2	128			:
SynCp	House	5768	MA_SynTriplet07_N	4/4	2	128			:
SynCp	House	5769	MA_SynTriplet07	4/4	2	128			:
SynCp	House	5770	MA_SynTriplet08_N	4/4	2	128			:
SynCp	House	5771	MA_SynTriplet09_N	4/4	2	128			:
SynCp	House	5772	MA_SynTriplet10_N	4/4	2	128			:
SynCp	House	5773	MA_SynthRiff6-01_N	4/4	4	128			:
SynCp	House	5774	MA_SynthRiff6-02	4/4	2	128			:
SynCp	House	5775	MA_SynthRiff6-03_N	4/4	2	128			:
SynCp	House	5776	MA_SynthRiff6-04_N	4/4	2	130			:
SynCp	House	5777	MA_SynthRiff6-05_N	4/4	2	130			:
SynCp	House	5778	MA_SynthRiff6-05	4/4	2	130			:
SynCp	House	5779	MA_SynthRiff6-06	4/4	2	130			:
SynCp	House	5780	MA_SynthRiff6-07	4/4	2	128			:
SynCp	House	5781	MA_SynthRiff6-08_N	4/4	2	128			:
SynCp	House	5782	MA_SynthRiff6-08	4/4	2	128			:
SynCp	House	5783	MA_SynthRiff6-09_N	4/4	2	128			:
SynCp	House	5784	MA_SynthRiff6-09	4/4	2	128			:
SynCp	House	5785	MA_SynthRiff6-10_N	4/4	2	128			:
SynCp	House	5786	MA_SynthRiff6-10	4/4	2	128			:
SynCp	House	5787	MA_16thPattern06	4/4	2	130			:
SynCp	House	5788	MA_16thPattern07	4/4	2	130			:
SynCp	House	5789	MA_16thPattern08	4/4	1	130			:
SynCp	House	5790	MA_16thPattern09	4/4	2	130			:
SynCp	House	5791	MA_16thPattern10_N	4/4	2	130			:
SynCp	House	5792	MA_16thPattern11	4/4	2	130			:
SynCp	House	5793	MA_16thPattern12	4/4	2	130			:
SynCp	House	5794	MA_16thPattern13	4/4	2	130			:
SynCp	House	5795	MA_16thPattern14_N	4/4	2	130			:
SynCp	House	5796	MA_16thPattern15_N	4/4	4	130			:
SynCp	House	5797	MA_16th SynPercArp1	4/4	2	127			:
SynCp	House	5798	MA_16th SynPercArp2	4/4	2	127			:
SynCp	House	5799	MA_16th SynPercArp3	4/4	2	127			:
SynCp	House	5800	MA_16th SynPercArp4	4/4	2	127			:
SynCp	House	5801	MA_MelodicPluck08	4/4	2	128			:
SynCp	House	5802	MA_MelodicPluck09_N	4/4	2	128			:
SynCp	House	5803	MA_MelodicPluck10	4/4	2	130			:
SynCp	House	5804	MA_SimpleNt 3-01_N	4/4	4	130			:
SynCp	House	5805	MA_SimpleNt 3-01	4/4	4	130			:
SynCp	House	5806	MA_SyChrdRiff2-1_N	4/4	4	130			:
SynCp	House	5807	MA_SyChrdRiff2-1	4/4	4	130			:
SynCp	House	5808	MA_SyChrdRiff2-2_N	4/4	2	130			:
SynCp	House	5809	MA_SyChrdRiff2-2	4/4	2	130			:
SynCp	House	5810	MA_SynthRiff7-01_N	4/4	2	130			:
SynCp	House	5811	MA_SynthRiff7-01	4/4	2	130			:
SynCp	House	5812	MA_SynthRiff7-02_N	4/4	2	130			:
SynCp	House	5813	MA_SynthRiff7-02	4/4	2	130			:
SynCp	House	5814	MA_AnalogDrumChords	4/4	2	111			:
SynCp	House	5815	MA_Analog Lead	4/4	2	99			:
SynCp	House	5816	MA_Anthem Party Arp	4/4	4	113			:
SynCp	House	5817	MA_Atrium Lead	4/4	2	125			:
SynCp	House	5818	MA_Baby Jump Lead	4/4	2	120			:
SynCp	House	5819	MA_Hit Lead	4/4	2	140			:
SynCp	House	5820	MA_Bromeo Sequence	4/4	2	120			:
SynCp	House	5821	MA_Colors Sequence	4/4	2	128			:
SynCp	House	5822	MA_EmoDM Chords	4/4	4	120			:
SynCp	House	5823	MA_Epoque Lead_N	4/4	2	122			:
SynCp	House	5824	MA_FunkyWalkChords	4/4	2	112			:
SynCp	House	5825	MA_Funky Walk Lead	4/4	2	112			:
SynCp	House	5826	MA_In My House Seq	4/4	2	117			:
SynCp	House	5827	MA_Make Me Sing Arp	4/4	2	126			:

Main Category	Sub Category	ARP No.	ARP Name	Time Signature	Length	Original Tempo	Accent	Random SFX	Sound Type
SynCp	House	5828	MA_Organa Arp	4/4	1	110			:
SynCp	House	5829	MA_Play Thing Arp	4/4	2	110			:
SynCp	House	5830	MA_More Air_N	4/4	2	130			:
SynCp	House	5831	MC1_Dream Dance	4/4	1	136			:
SynCp	House	5832	FC1_Dream Dance	4/4	1	136			:
SynCp	House	5833	MA2_Dream Dance	4/4	1	136			:
SynCp	House	5834	MD2_Dream Dance	4/4	1	136			:
SynCp	House	5835	FC2_Dream Dance	4/4	1	136			:
SynCp	House	5836	MB3_Dream Dance	4/4	1	136			:
SynCp	House	5837	MD1_Ibiza	4/4	2	135			:
SynCp	House	5838	IA1_Ibiza	4/4	8	135			:
SynCp	House	5839	MB2_Ibiza_N	4/4	2	135			:
SynCp	House	5840	MD2_Ibiza_N	4/4	2	135			:
SynCp	House	5841	MB3_Ibiza_N	4/4	2	135			:
SynCp	House	5842	MC3_Ibiza_N	4/4	2	135			:
SynCp	House	5843	MA_Retro Pop	4/4	1	126			:
SynCp	House	5844	MD_Retro Pop	4/4	2	126			:
SynCp	House	5845	FC_Retro Pop	4/4	1	100			:
SynCp	House	5846	IA_Dream Dance	4/4	2	136			:
SynCp	House	5847	MA_Ibiza	4/4	1	135			:
SynCp	House	5848	MB_Ibiza	4/4	2	135			:
SynCp	House	5849	MC_Ibiza	4/4	2	135			:
SynCp	House	5850	MD_Ibiza	4/4	2	135			:
SynCp	House	5851	IA_Ibiza	4/4	8	135			:
SynCp	House	5852	FA_Ibiza	4/4	1	135			:
SynCp	House	5853	FB_Ibiza	4/4	1	135			:
SynCp	House	5854	MB_Garage 2	4/4	2	127			:
SynCp	House	5855	MC_Garage 2	4/4	2	127			:
SynCp	House	5856	MD_Garage 2	4/4	2	127			:
SynCp	House	5857	IA_Garage 2	4/4	2	127			:
SynCp	House	5858	FA_Garage 2	4/4	2	127			:
SynCp	D&B	5859	MA_Big Beat 1_N	4/4	4	115			:
SynCp	D&B	5860	MB_Big Beat 1_N	4/4	4	115			:
SynCp	D&B	5861	MC_Big Beat 1_N	4/4	4	115			:
SynCp	D&B	5862	FA_Big Beat 1_N	4/4	1	115			:
SynCp	D&B	5863	FB_Big Beat 1_N	4/4	1	115			:
SynCp	D&B	5864	FC_Big Beat 1_N	4/4	1	115			:
SynCp	D&B	5865	BA_Big Beat 1_N	4/4	1	115			:
SynCp	D&B	5866	MA_Big Step1_N	4/4	2	116			:
SynCp	D&B	5867	MA_Big Step2_N	4/4	1	116			:
SynCp	D&B	5868	MA_Big Step3_N	4/4	2	116			:
SynCp	D&B	5869	MA_Big Step4_N	4/4	1	116			:
SynCp	D&B	5870	MA_Big Step5_N	4/4	1	116			:
SynCp	D&B	5871	MA_Breakbeats 1_N	4/4	4	115			:
SynCp	D&B	5872	MB_Breakbeats 1_N	4/4	4	115			:
SynCp	D&B	5873	MC_Breakbeats 1_N	4/4	2	115			:
SynCp	D&B	5874	FA_Breakbeats 1_N	4/4	1	115			:
SynCp	D&B	5875	FB_Breakbeats 1_N	4/4	1	115			:
SynCp	D&B	5876	FC_Breakbeats 1	4/4	1	115			:
SynCp	D&B	5877	BA_Breakbeats 1_N	4/4	1	115			:
SynCp	D&B	5878	MA_Breakbeats 2_N	4/4	4	88			:
SynCp	D&B	5879	MB_Breakbeats 2_N	4/4	4	88			:
SynCp	D&B	5880	MC_Breakbeats 2_N	4/4	4	88			:
SynCp	D&B	5881	FA_Breakbeats 2_N	4/4	1	88			:
SynCp	D&B	5882	FB_Breakbeats 2_N	4/4	1	88			:
SynCp	D&B	5883	FC_Breakbeats 2	4/4	1	88			:
SynCp	D&B	5884	BA_Breakbeats 2_N	4/4	1	88			:
SynCp	Chill	5885	MA_EDM Ballad Lead	4/4	4	120			:
SynCp	Chill	5886	MA_Squad Theme_N	4/4	1	120			:
SynCp	Chill	5887	MA_Arptelligence_N	4/4	1	120			:
SynCp	Chill	5888	MA_Wind Dancer_N	4/4	1	130			:
SynCp	Chill	5889	MA_Landing Gear_N	4/4	1	120			:
SynCp	Chill	5890	MA1_Ambient 1_N	4/4	4	102			:
SynCp	Chill	5891	MB1_Ambient 1	4/4	4	102			:
SynCp	Chill	5892	MC1_Ambient 1_N	4/4	4	102			:
SynCp	Chill	5893	FA1_Ambient 1_N	4/4	1	102			:
SynCp	Chill	5894	FB1_Ambient 1	4/4	1	102			:
SynCp	Chill	5895	FC1_Ambient 1_N	4/4	1	102			:
SynCp	Chill	5896	BA1_Ambient 1_N	4/4	1	102			:
SynCp	Chill	5897	MB2_Ambient 1_N	4/4	4	102			:
SynCp	Chill	5898	MC2_Ambient 1_N	4/4	4	102			:
SynCp	Chill	5899	FB2_Ambient 1_N	4/4	1	102			:
SynCp	Chill	5900	FC2_Ambient 1_N	4/4	1	102			:
SynCp	Chill	5901	BA2_Ambient 1_N	4/4	1	102			:
SynCp	Chill	5902	MA1_Ambient 2_C	4/4	4	111</			

Main Category	Sub Category	ARP No.	ARP Name	Time Signature	Length	Original Tempo	Accent	Random SFX	Sound Type
SynCp	Chill	5915	MC1_Ambient 2_N	4/4	4	111			:
SynCp	Chill	5916	FB1_Ambient 2_N	4/4	8	111			:
SynCp	Chill	5917	FC1_Ambient 2_N	4/4	1	111			:
SynCp	Chill	5918	MA2_Ambient 2_N	4/4	4	111			:
SynCp	Chill	5919	MC2_Ambient 2	4/4	4	111			:
SynCp	Chill	5920	FA2_Ambient 2_N	4/4	1	111			:
SynCp	Chill	5921	FB2_Ambient 2_N	4/4	8	111			:
SynCp	Chill	5922	FC2_Ambient 2_N	4/4	1	111			:
SynCp	Chill	5923	BA2_Ambient 2_N	4/4	2	111			:
SynCp	Chill	5924	MA1_Ambient 3	4/4	4	75			:
SynCp	Chill	5925	MA2_Ambient 3	4/4	4	75			:
SynCp	Chill	5926	MA3_Ambient 3	4/4	2	75			:
SynCp	Chill	5927	MA_Ambient 4	4/4	1	80			:
SynCp	Chill	5928	MA_Ambient 4 AF2	4/4	1	80			:
SynCp	Chill	5929	MC_Chill Out	4/4	4	79			:
SynCp	Chill	5930	MD_Chill Out	4/4	2	79			:
SynCp	Chill	5931	FB_Chill Out	4/4	1	79			:
SynCp	Chill	5932	MA_Synth Pop	4/4	1	90			:
SynCp	Chill	5933	MB_Synth Pop	4/4	1	90			:
SynCp	Chill	5934	MD_Synth Pop	4/4	1	90			:
SynCp	Chill	5935	IA_Synth Pop	4/4	1	90			:
SynCp	Chill	5936	FC_Synth Pop	4/4	1	90			:
SynCp	Chill	5937	MA_Chill Out	4/4	2	79			:
SynCp	Chill	5938	MB_Chill Out	4/4	2	79			:
SynCp	Chill	5939	FA_Chill Out	4/4	1	79			:
SynCp	Chill	5940	MA_ChillinChord1	4/4	1	90			:
SynCp	Chill	5941	MA_ChillinChord1 AF2	4/4	1	90			:
SynCp	Chill	5942	MA_ChillinChord1 AF1&2	4/4	1	90			:
SynCp	Chill	5943	MA_ChillinChord2	4/4	1	90			:
SynCp	Chill	5944	MA_ChillinChord2 AF1	4/4	1	90			:
SynCp	Chill	5945	MA_ChillinChord3	4/4	1	90			:
SynCp	Chill	5946	MA_ChillinChord4	4/4	1	90			:
SynCp	Chill	5947	MA_ChillinChord5	4/4	1	90			:
SynCp	Chill	5948	MA_ChillinChord6	4/4	1	90			:
SynCp	Chill	5949	MA_ChillinChord6 AF1	4/4	1	90			:
SynCp	Chill	5950	MA1_Eighties	4/4	1	120			:
SynCp	Chill	5951	MB1_Eighties	4/4	1	120			:
SynCp	Chill	5952	MC1_Eighties	4/4	1	120			:
SynCp	Chill	5953	MD1_Eighties	4/4	1	120			:
SynCp	Chill	5954	MA2_Eighties	4/4	1	120			:
SynCp	Chill	5955	MA2_Eighties AF1	4/4	1	120			:
SynCp	Chill	5956	MA2_Eighties AF2	4/4	1	120			:
SynCp	Chill	5957	MB2_Eighties	4/4	1	120			:
SynCp	Chill	5958	MB2_Eighties AF1	4/4	1	120			:
SynCp	Chill	5959	MA3_Eighties	4/4	1	120			:
SynCp	Chill	5960	MA3_Eighties AF1	4/4	1	120			:
SynCp	Chill	5961	MB3_Eighties	4/4	1	120			:
SynCp	Latin	5962	MA_Latin House	4/4	4	138			:
SynCp	Latin	5963	MB_Latin House	4/4	2	138			:
SynCp	World	5964	MA_TurkishEuro2_C	4/4	4	120			:
SynCp	World	5965	MB_TurkishEuro2_C	4/4	4	120			:
SynCp	World	5966	MC_TurkishEuro2_C	4/4	4	120			:
SynCp	World	5967	FA_TurkishEuro2_C	4/4	1	120			:
SynCp	World	5968	FB_TurkishEuro2_C	4/4	1	120			:
SynCp	World	5969	FC_TurkishEuro2_C	4/4	1	120			:
SynCp	World	5970	BA_TurkishEuro2_C	4/4	1	120			:
SynCp	World	5971	EA_TurkishEuro2_C	4/4	3	120			:
SynCp	General	5972	MA_Up Oct1	4/4	1	120			:
SynCp	General	5973	MA_Up Oct2	4/4	1	120			:
SynCp	General	5974	MA_Up Oct3	4/4	1	120			:
SynCp	General	5975	MA_Up Oct4	4/4	1	120			:
SynCp	General	5976	MA_Down Oct1	4/4	1	120			:
SynCp	General	5977	MA_Down Oct2	4/4	1	120			:
SynCp	General	5978	MA_Down Oct3	4/4	1	120			:
SynCp	General	5979	MA_Down Oct4	4/4	1	120			:
SynCp	General	5980	MA_U/D A Oct1	4/4	1	120			:
SynCp	General	5981	MA_U/D A Oct2	4/4	1	120			:
SynCp	General	5982	MA_U/D A Oct3	4/4	1	120			:
SynCp	General	5983	MA_U/D A Oct4	4/4	1	120			:
SynCp	General	5984	MA_U/D B Oct1	4/4	1	120			:
SynCp	General	5985	MA_U/D B Oct2	4/4	1	120			:
SynCp	General	5986	MA_U/D B Oct3	4/4	1	120			:
SynCp	General	5987	MA_U/D B Oct4	4/4	1	120			:
SynCp	General	5988	MA_Random Oct1	4/4	1	120			:
SynCp	General	5989	MA_Random Oct2	4/4	1	120			:
SynCp	General	5990	MA_Random Oct3	4/4	1	120			:
SynCp	General	5991	MA_Random Oct4	4/4	1	120			:
SynCp	General	5992	MA_Oct2 Up	4/4	1	120			:
SynCp	General	5993	MA_Oct4 Up	4/4	1	120			:
SynCp	General	5994	MA_Unison Up	4/4	1	120			:
SynCp	General	5995	MA_Up&Alt1	4/4	1	120			:
SynCp	General	5996	MA_Up&Down1	4/4	1	120			:
SynCp	General	5997	MA_Up&Down2	4/4	1	120			:
SynCp	General	5998	MA_Up&Down3	4/4	1	120			:
SynCp	General	5999	MA_Up&Down4	4/4	1	120			:
SynCp	General	6000	MA_Up&Random1	4/4	1	120			:
SynCp	General	6001	MA_Up&Random2	4/4	1	120			:

Main Category	Sub Category	ARP No.	ARP Name	Time Signature	Length	Original Tempo	Accent	Random SFX	Sound Type
SynCp	General	6002	MA_Up&Random3	4/4	1	120			:
SynCp	General	6003	MA_Up&Random4	4/4	1	120			:
SynCp	General	6004	MA_ClassicArp2-01_N	4/4	4	130			:
SynCp	General	6005	MA_ClassicArp2-01	4/4	4	130			:
SynCp	General	6006	MA_ClassicArp2-02_N	4/4	4	130			:
SynCp	General	6007	MA_ClassicArp2-02	4/4	4	130			:
SynCp	General	6008	MA_ClassicArp2-03_N	4/4	2	130			:
SynCp	General	6009	MA_ClassicArp2-03	4/4	2	130			:
SynCp	General	6010	MA_ClassicArp2-04	4/4	1	130			:
SynCp	General	6011	MA_ClassicArp2-05	4/4	1	130			:
SynCp	General	6012	MA_ClassicArp2-06_N	4/4	4	130			:
SynCp	General	6013	MA_ClassicArp2-06	4/4	4	130			:
SynCp	General	6014	MA_ClassicArp2-07	4/4	1	130			:
SynCp	General	6015	MA_ClassicArp2-08_N	4/4	1	130			:
SynCp	General	6016	MA_ClassicArp2-08	4/4	1	130			:
SynCp	General	6017	MA_ClassicArp2-09_N	4/4	2	130			:
SynCp	General	6018	MA_ClassicArp2-09	4/4	2	130			:
SynCp	General	6019	MA_ClassicArp2-10_N	4/4	1	130			:
SynCp	General	6020	MA_ClassicArp2-10	4/4	1	130			:
SynCp	General	6021	MA_ClassicArp2-11_N	4/4	1	130			:
SynCp	General	6022	MA_ClassicArp2-11	4/4	1	130			:
SynCp	General	6023	MA_ClassicArp2-12_N	4/4	2	130			:
SynCp	General	6024	MA_ClassicArp2-12	4/4	2	130			:
SynCp	General	6025	MA_ClassicArp2-13_N	4/4	4	130			:
SynCp	General	6026	MA_ClassicArp2-13	4/4	4	130			:
SynCp	General	6027	MA_ClassicArp2-14_N	4/4	2	130			:
SynCp	General	6028	MA_ClassicArp2-15	4/4	1	130			:
SynCp	General	6029	MA_ClassicArp2-16	4/4	1	130			:
SynCp	General	6030	MA_SynArp1	4/4	1	130			:
SynCp	General	6031	MA_SynArp2	4/4	2	130			:
SynCp	General	6032	MA_SynArp3	4/4	1	130			:
SynCp	General	6033	MA_SynArp4	4/4	1	130			:
SynCp	General	6034	MA_SynArp5	4/4	1	130			:
SynCp	General	6035	MA_SynArp6	4/4	1	124			:
SynCp	General	6036	MA_SynArp7	4/4	1	120			:
SynCp	General	6037	MA_SynArp8	4/4	1	130			:
SynCp	General	6038	MA_SynArp9	4/4	1	130			:
SynCp	General	6039	MA_SynArp10	4/4	1	130			:
SynCp	General	6040	MA_SynArp11	4/4	2	130			:
SynCp	General	6041	MA_SynArp12	4/4	1	90			:
SynCp	General	6042	MA_SynArp13	4/4	2	124			:
SynCp	General	6043	MA_SynArp14	4/4	1	130			:
SynCp	General	6044	MA_SynArp15	4/4	1	130			:
SynCp	General	6045	MA_SynArp16	4/4	1	130			:
SynCp	General	6046	MA_SynArp17	4/4	1	90			:
SynCp	General	6047	MA_SynArp18	4/4	1	130			:
SynCp	General	6048	MA_SynArp19	4/4	1	120			:
SynCp	General	6049	MA_SynArp20	4/4	1	120			:
SynCp	General	6050	MA_SynArp21	4/4	1	124			:
SynCp	General	6051	MA_SynArp22	4/4	1	120			:
SynCp	General	6052	MA_SynArp23	4/4	1	138			:
SynCp	General	6053	MA_SynArp24	4/4	1	138			:
SynCp	General	6054	MA_SynArp25	4/4	1	120			:
SynCp	General	6055	MA_SynArp26	4/4	1	120			:
SynCp	General	6056	MA_SynArp27	4/4	1	120			:
SynCp	General	6057	MA_SynArp28	1/4	10	125			:
SynCp	General	6058	MA_SynArp29	4/4	5	120			:
SynCp	General	6059	MA_Melody1	4/4	1	70			:
SynCp	General	6060	MA_Melody2	4/4	1	120			:
SynCp	General	6061	MA_Melody3	4/4	1	70			:
SynCp	General	6062	MA_Melody4	4/4	1	70			:
SynCp	General	6063	MA_Melody5	4/4	1	70			:
SynCp	General	6064	MA_Melody6	4/4	1	70			:
SynCp	General	6065	MA_Melody7	4/4	1	70			:
SynCp	General	6066	MA_Melody8	4/4	1	70			:
SynCp	General	6067	MA_Melody9	4/4	1	70			:
SynCp	General	6068	MA_Melody10	4/4	1	70			:
SynCp	General	6069	MA_Melody11	4/4	1	70			:
SynCp	General	6070	MA_Melody12	4/4	1	70			:
SynCp	General	6071	MA_Melody13	4/4	1	70			:
SynCp	General	6072	MA_Melody14	4/4	1	70			:
SynCp	General	6073	MA_Melody15	4/4	1	70			:
SynCp	General	6074	MA_Melody16	4/4	1	70			:
SynCp	General	6075	MA_Melody17	4/4	1	70			:
SynCp	General	6076	MA_Melody17 AF1	4/4	1	119			:
SynCp	General	6077	MA_Melody17 AF2	4/4	1	119			:
SynCp	General	6078	MA_Melody18	4/4	1	70			:

Main Category	Sub Category	ARP No.	ARP Name	Time Signature	Length	Original Tempo	Accent	Random SFX	Sound Type
SynCp	General	6089	MA_SynthPhrase2_C	4/4	1	70			:
SynCp	General	6090	MA_SynthPhrase3_C	4/4	1	70			:
SynCp	General	6091	MA_SynthPhrase4_C	4/4	1	70			:
SynCp	General	6092	MA_SynthPhrase5_C	4/4	1	70			:
SynCp	General	6093	MA_SynthPhrase6_C	4/4	1	70			:
SynCp	General	6094	MA_SynthPhrase7_C	4/4	1	70			:
SynCp	General	6095	MA_SynthPhrase8_C	4/4	1	70			:
SynCp	General	6096	MA_SynthPhrase9_C	4/4	1	70			:
SynCp	General	6097	MA_SynthPhrase10_C	4/4	1	70			:
SynCp	General	6098	MA_SynthPhrase11_C	4/4	1	70			:
SynCp	General	6099	MA_SynthPhrase12_C	4/4	1	70			:
SynCp	General	6100	MA_SynthPhrase13_C	4/4	1	130			:
SynCp	General	6101	MA_SynthPhrase14_C	4/4	1	130			:
SynCp	General	6102	MA_SynthPhrase15_C	4/4	1	130			:
SynCp	General	6103	MA_SynthPhrase16_C	4/4	1	130			:
SynCp	General	6104	MA_SynthPhrase17_C	4/4	1	130			:
SynCp	General	6105	MA_SynthPhrase18_C	4/4	1	130			:
SynCp	General	6106	MA_SynthPhrase19_C	4/4	1	130			:
SynCp	General	6107	MA_SynthPhrase20_C	4/4	1	130			:
SynCp	General	6108	MA_SynthPhrase21_C	4/4	1	130			:
SynCp	General	6109	MA_SynthPhrase22_C	4/4	1	130			:
SynCp	General	6110	MA_SynthPhrase23_C	4/4	1	130			:
SynCp	General	6111	MA_SynthPhrase24_C	4/4	1	130			:
SynCp	General	6112	MA_SynthPhrase25_C	4/4	1	130			:
SynCp	General	6113	MA_SynthPhrase26_C	4/4	1	130			:
SynCp	General	6114	MA_SynthPhrase27_C	4/4	1	130			:
SynCp	General	6115	MA_SynthPhrase28_C	4/4	1	130			:
SynCp	General	6116	MA_SynthPhrase29_C	4/4	1	130			:
SynCp	General	6117	MA_SynthPhrase30_C	4/4	1	130			:
SynCp	General	6118	MA_SynthPhrase31_C	4/4	1	130			:
SynCp	General	6119	MA_SynthPhrase32_C	4/4	1	130			:
SynCp	General	6120	MA_SynthPhrase33_C	4/4	1	130			:
SynCp	General	6121	MA_SynthPhrase34_C	4/4	1	140			:
SynCp	General	6122	MA_SynthPhrase35_C	4/4	1	130			:
SynCp	General	6123	MA_SynthPhrase36_C	4/4	1	130			:
SynCp	General	6124	MA_SynthPhrase37_C	4/4	1	130			:
SynCp	General	6125	MA_SynthPhrase38_C	4/4	1	130			:
SynCp	General	6126	MA_SynthPhrase39_C	4/4	1	130			:
SynCp	General	6127	MA_SynthPhrase40_C	4/4	1	120			:
SynCp	General	6128	MA_SynthPhrase41_C	4/4	1	120			:
SynCp	General	6129	MA_SynthPhrase42_C	4/4	1	140			:
SynCp	General	6130	MA_SynthPhrase43_C	4/4	4	140			:
SynCp	General	6131	MA_SynthPhrase44_C	4/4	1	136			:
SynCp	General	6132	MA_SynthPhrase45_C	4/4	1	136			:
SynCp	General	6133	MA_SynthPhrase46_C	4/4	2	135			:
SynCp	General	6134	MA_SynthPhrase47_C	4/4	1	130			:
SynCp	General	6135	MA_SynthPhrase48_C	4/4	1	130			:
SynCp	General	6136	MA_SynthPhrase49_C	4/4	1	130			:
SynCp	General	6137	MA_SynthPhrase50_C	4/4	1	116			:
SynCp	General	6138	MA_SynthPhrase51_C	4/4	1	100			:
SynCp	General	6139	MA_SynthPhrase52_C	4/4	1	138			:
SynCp	General	6140	MA_Oct Seq1	4/4	1	130			:
SynCp	General	6141	MA_Oct Seq2	4/4	1	130			:
SynCp	General	6142	MA_Oct Seq3	4/4	1	130			:
SynCp	General	6143	MA_Oct Seq4	4/4	1	130			:
SynCp	General	6144	MA_Oct Seq5	4/4	1	130			:
SynCp	General	6145	MA_Oct Seq6	4/4	1	90			:
SynCp	General	6146	MA_Oct Seq7	4/4	1	90			:
SynCp	General	6147	MA_Oct Seq8	4/4	1	90			:
SynCp	General	6148	MA_Random Seq1	4/4	1	90			:
SynCp	General	6149	MA_Random Seq2	4/4	1	90			:
SynCp	General	6150	MA_Random Seq3	4/4	1	90			:
SynCp	General	6151	MA_RndmNotesSeq	4/4	1	70			:
SynCp	General	6152	MA_Vel Grv1	4/4	1	134			:
SynCp	General	6153	MA_Vel Grv2	4/4	1	134			:
SynCp	General	6154	MA_X-Sweep1	4/4	1	140			:
SynCp	General	6155	MA_X-Sweep2	4/4	1	140			:
SynCp	General	6156	MA_X-Sweep3	4/4	1	140			:
SynCp	General	6157	MA_Simple1	4/4	1	130			:
SynCp	General	6158	MA_Simple2	4/4	1	130			:
SynCp	General	6159	MA_Simple3	4/4	1	130			:
SynCp	General	6160	MA_Simple4	4/4	1	130			:
SynCp	General	6161	MA_Simple5	4/4	1	130			:
SynCp	General	6162	MA_Basic1	4/4	1	130			:
SynCp	General	6163	MA_Basic1 AF2	4/4	8	134			:
SynCp	General	6164	MA_Basic2	4/4	1	130			:
SynCp	General	6165	MA_Basic3	4/4	1	130			:
SynCp	General	6166	MA_FifthSQ1	4/4	1	130			:
SynCp	General	6167	MA_FifthSQ2	4/4	1	130			:
SynCp	General	6168	MA_FifthSQ3	4/4	1	130			:
SynCp	General	6169	MA_FifthSQ4	4/4	1	130			:
SynCp	General	6170	MA_FifthSQ5	4/4	1	130			:
SynCp	General	6171	MA_FifthSQ6	4/4	1	130			:
SynCp	General	6172	MA_MuteArp1	4/4	1	120			:
SynCp	General	6173	MA_MuteArp2	4/4	1	120			:
SynCp	General	6174	MA_MuteLine	4/4	1	134			:
SynCp	General	6175	MA_Chodad	4/4	2	150			:

Main Category	Sub Category	ARP No.	ARP Name	Time Signature	Length	Original Tempo	Accent	Random SFX	Sound Type
SynCp	General	6176	MA_Wavetable8th	4/4	1	120			:
SynCp	General	6177	MA_Wavetable16th	4/4	1	90			:
SynCp	General	6178	MA_Syn Chord1	4/4	1	130			:
SynCp	General	6179	MA_Syn Chord2	4/4	1	90			:
SynCp	General	6180	MA_Syn Chord3	4/4	1	120			:
SynCp	General	6181	MA_Syn Chord4	4/4	1	130			:
SynCp	General	6182	MA_Syn Chord5	4/4	1	130			:
SynCp	General	6183	MA_Syn Chord6	4/4	1	130			:
SynCp	General	6184	MA_Syn Chord7	4/4	1	130			:
SynCp	General	6185	MA_Syn Chord8	4/4	1	90			:
SynCp	General	6186	MA_Syn Chord9	4/4	1	120			:
SynCp	General	6187	MA_Syn Chord10	4/4	1	116			:
SynCp	General	6188	MA_Syn Chord11	4/4	4	130			:
SynCp	General	6189	MA_Syn Chord12	4/4	1	124			:
SynCp	General	6190	MA_Syn Chord13	4/4	1	140			:
SynCp	General	6191	MA_Syn Chord14	4/4	2	130			:
SynCp	General	6192	MA_Syn Chord15	4/4	2	134			:
SynCp	General	6193	MA_Syn Chord16	4/4	1	138			:
SynCp	General	6194	MA_BassChord1	4/4	2	130			:
SynCp	General	6195	MA_BassChord2	4/4	2	130			:
SynCp	General	6196	MA_BassChord3	4/4	2	130			:
SynCp	General	6197	MA_BassChord4	4/4	2	130			:
SynCp	General	6198	MA_BassChord5	4/4	2	130			:
SynCp	General	6199	MA_BassChord6	4/4	2	130			:
SynCp	General	6200	MA_BassChord7	4/4	2	130			:
SynCp	General	6201	MA_BassChord8	4/4	2	130			:
SynCp	General	6202	MA_BassChord9	4/4	1	130			:
SynCp	General	6203	MA_BassChord10	4/4	1	130			:
SynCp	General	6204	MA_BassChord11	4/4	1	130			:
SynCp	General	6205	MA_BassChord12	4/4	1	130			:
SynCp	General	6206	MA_BassChord13	4/4	2	130			:
SynCp	General	6207	MA_BassChord14	4/4	1	130			:
SynCp	General	6208	MA_BassChord15	4/4	2	130			:
SynCp	General	6209	MA_BassChord16	4/4	1	130			:
SynCp	General	6210	MA_BassChord17	4/4	1	130			:
SynCp	General	6211	MA_BassChord18	4/4	2	130			:
SynCp	General	6212	MA_BassChord19	4/4	1	130			:
SynCp	General	6213	MA_BassChord20	4/4	1	130			:
SynCp	General	6214	MA_Chord AIB1	4/4	1	120			:
SynCp	General	6215	MA_Chord AIB2	4/4	1	120			:
SynCp	General	6216	MA_Chord AIB4	4/4	1	120			:
SynCp	General	6217	MA_ChordRandom1	4/4	1	120			:
SynCp	General	6218	MA_ChordRandom2	4/4	1	120			:
SynCp	General	6219	MA_ChordRandom4	4/4	1	120			:
CPerc	Modern R&B	6220	FB_R&B Disco_N	4/4	1	110			Chromatic Perc.
CPerc	Modern R&B	6221	FC_R&B Disco_N	4/4	2	110			:
CPerc	Techno	6222	MC_Trance 5	4/4	4	140			:
CPerc	House	6223	MA_ChromPerc_01_N	4/4	2	120			Marimba
CPerc	House	6224	MA_ChromPerc_01	4/4	2	120			:
CPerc	House	6225	MA_ChromPerc_02_N	4/4	2	120			:
CPerc	House	6226	MA_ChromPerc_02	4/4	2	120			:
CPerc	House	6227	MA_ChromPerc_03_N	4/4	2	120			:
CPerc	House	6228	MA_ChromPerc_03	4/4	2	120			:
CPerc	House	6229	MA_ChromPerc_04_N	4/4	2	120			:
CPerc	House	6230	MA_ChromPerc_04	4/4	2	120			:
CPerc	House	6231	MA_ChromPerc_05_N	4/4	4	120			:
CPerc	House	6232	MA_ChromPerc_06_N	4/4	2	120			Steel Drum
CPerc	House	6233	MA_ChromPerc_06	4/4	2	120			:
CPerc	House	6234	MA_ChromPerc_07_N	4/4	2	122			:
CPerc	House	6235	MA_ChromPerc_07	4/4	2	122			:
CPerc	House	6236	MA_ChromPerc_08_N	4/4	2	122			:
CPerc	House	6237	MA_ChromPerc_08	4/4	2	122			:
CPerc	House	6238	MA_ChromPerc_09_N	4/4	2	122			:
CPerc	House	6239	MA_ChromPerc_09	4/4	2	122			:
CPerc	House	6240	MA_ChromPerc_10_N	4/4	2	122			:
CPerc	House	6241	MA_ChromPerc_10	4/4	2	122			:
CPerc	House	6242	MA_Dance 1_N	4/4	2	120			Chromatic Perc.
CPerc	House	6243	MA_Dance 1	4/4	2	120			:
CPerc	House	6244	MA_Dance 2_N	4/4	2	125			:
CPerc	House	6245	MA_Dance 2	4/4	2	125			:
CPerc	House	6246	MA_Dance 3_N	4/4	2	120			:
CPerc	House	6247	MA_Dance 3	4/4	2	120			:
CPerc	House	6248	MA_Dance 4_N	4/4	2	120			:
CPerc	House	6249	MA_Dance 4	4/4	2	120			:
CPerc	House	6250	MA_Dance 5_N	4/4	2	125			:
CPerc	House	6251	MA_Dance 5	4/4	2	125			:
CPerc	House	6252	MA_In My House Bell	4/4	2	117			:
CPerc	Chill	6253	MA_Pitch Bell_N	4/4	1	130			:

Arpeggio Type List

Main Category	Sub Category	ARP No.	ARP Name	Time Signature	Length	Original Tempo	Accent	Random SFX	Sound Type
CPerc	General	6263	MB_Tubular Bell_N	4/4	2	100			:
CPerc	General	6264	MC_Tubular Bell_N	4/4	4	100			:
CPerc	General	6265	MD_Tubular Bell_N	4/4	2	100			:
CPerc	General	6266	ME_Tubular Bell_N	4/4	1	100			:
CPerc	General	6267	MA_Real Timpani_N	4/4	2	120			Real Timpani AF2 Mfl
CPerc	General	6268	MB_Real Timpani	4/4	2	120			:
CPerc	General	6269	MC_Real Timpani	4/4	3	120			:
CPerc	General	6270	MD_Real Timpani_N	4/4	1	120			:
CPerc	General	6271	ME_Real Timpani_N	4/4	3	120			:
CPerc	General	6272	MF_Real Timpani_N	4/4	6	120			:
CPerc	General	6273	MA_RealTimpan AF2_N	4/4	2	110			:
CPerc	General	6274	MB_RealTimpan AF2_N	4/4	1	110			:
CPerc	General	6275	MC_RealTimpan AF2_N	4/4	2	110			:
CPerc	General	6276	MD_RealTimpan AF2_N	4/4	2	110			:
CPerc	General	6277	ME_RealTimpan AF2_N	4/4	2	110			:
CPerc	General	6278	Timpani Roll	4/4	1	102			Timpani
CPerc	General	6279	Mallet Roll1	4/4	2	120			Chromatic Perc.
CPerc	General	6280	Mallet Roll2	4/4	2	120			:
CPerc	General	6281	MOD1	4/4	1	120			:
CPerc	General	6282	MOD2	4/4	2	120			:
CPerc	General	6283	MOD3	4/4	1	120			:
CPerc	General	6284	Trill 1	4/4	1	120			:
CPerc	General	6285	Trill 2	4/4	2	120			:
CPerc	General	6286	Trill 3	4/4	2	120			:
CPerc	General	6287	Steel Drum1	4/4	1	160			Steel Drum
CPerc	General	6288	Steel Drum2	4/4	2	95			:
CPerc	General	6289	Bell Tree1	4/4	3	120			Chromatic Perc.
CPerc	General	6290	Bell Tree2	4/4	3	120			:
CPerc	General	6291	Crescendo	4/4	1	120			:
Dr/Pc	Rock	6292	*1 MA_Rock Loop 1	4/4	4	137	●		Rock Stereo Kit 2
Dr/Pc	Rock	6293	*1 MA_Rock Loop 2-1	4/4	4	162	●		:
Dr/Pc	Rock	6294	*1 MA_Rock Loop 2-2	4/4	4	192	●		:
Dr/Pc	Rock	6295	*1 MA_Rock Loop 3	4/4	4	184	●		Real Drums Kit
Dr/Pc	Rock	6296	*1 MA_Rock Loop 4-1	4/4	4	92	●		Modern Rock Kit
Dr/Pc	Rock	6297	*1 MA_Rock Loop 4-2	4/4	4	117	●		:
Dr/Pc	Rock	6298	*1 MA_Rock Loop 5	4/4	4	122	●		:
Dr/Pc	Rock	6299	*1 MA_Rock Loop 6	4/4	4	120	●		:
Dr/Pc	Rock	6300	*1 MA_Rock Loop 7	4/4	4	130	●		Real Drums Kit
Dr/Pc	Rock	6301	*1 MA_Rock Loop 8	4/4	4	170	●		:
Dr/Pc	Rock	6302	*1 MA_Rock Loop 9-1	4/4	4	115	●		Hyper Standard Kit
Dr/Pc	Rock	6303	*1 MA_Rock Loop 9-2	4/4	4	72	●		:
Dr/Pc	Rock	6304	*1 MA_Rock Loop 9-3	4/4	4	130	●		Rock Stereo Kit 2
Dr/Pc	Rock	6305	*1 MA_Rock Loop 10-1	4/4	4	120	●		Real Drums Kit
Dr/Pc	Rock	6306	*1 MA_Rock Loop 10-2	4/4	4	120	●		Modern Rock Kit
Dr/Pc	Rock	6307	*1 MA_Rock Loop 11	4/4	4	168	●		Real Drums Kit
Dr/Pc	Rock	6308	*1 MA_Rock Loop 12	4/4	4	116	●		Hyper Standard Kit
Dr/Pc	Rock	6309	*1 MA_Rock Loop 13	4/4	4	123	●		:
Dr/Pc	Rock	6310	*1 MA_Rock Loop 14	4/4	4	129	●		Modern Rock Kit
Dr/Pc	Rock	6311	*1 MA_AllRock Loop 1	4/4	4	140	●		Rock Stereo Kit 1
Dr/Pc	Rock	6312	*1 MA_AllRock Loop 2	4/4	4	89	●		New Oak Custom Kit
Dr/Pc	Rock	6313	*1 MA_AllRock Loop 3	4/4	4	115	●		:
Dr/Pc	Rock	6314	*1 MA_AllRock Loop 4-1	4/4	4	79	●		Dry Standard Kit
Dr/Pc	Rock	6315	*1 MA_AllRock Loop 4-2	4/4	4	69	●		BeechwoodSnare Kit
Dr/Pc	Rock	6316	*1 MA_AllRock Loop 5-1	4/4	4	146	●		:
Dr/Pc	Rock	6317	*1 MA_AllRock Loop 5-2	4/4	4	130	●		:
Dr/Pc	Rock	6318	*1 MA_AllRock Loop 5-3	4/4	4	130	●		:
Dr/Pc	Rock	6319	*1 MA_AllRock Loop 6	6/8	4	71	●		New Oak Custom Kit
Dr/Pc	Rock	6320	*1 MA_AllRock Loop 7	4/4	4	136	●		:
Dr/Pc	Rock	6321	*1 MA_AllRock Loop 8	4/4	4	120	●		BeechwoodSnare Kit
Dr/Pc	Rock	6322	*1 MA_AllRock Loop 9	4/4	4	117	●		Hyper Standard Kit
Dr/Pc	Rock	6323	*1 MA_AllRock Loop 10-1	4/4	4	106	●		BeechwoodSnare Kit
Dr/Pc	Rock	6324	*1 MA_AllRock Loop 10-2	4/4	4	98	●		Modern Rock Kit
Dr/Pc	Rock	6325	*1 MA_AllRock Loop 11	4/4	4	127	●		BeechwoodSnare Kit
Dr/Pc	Rock	6326	*1 MA_AllRock Loop 12	4/4	4	127	●		PowerStandardKit 1
Dr/Pc	Rock	6327	*1 MA_AllRock Loop 13	4/4	4	120	●		Rock Stereo Kit 1
Dr/Pc	Rock	6328	*1 MA_AllRock Loop 14	3/4	4	92	●		NewMapleCustom Kit
Dr/Pc	Rock	6329	*1 MA_AllRock Loop 15	4/4	2	72	●		D'elo Kit
Dr/Pc	Rock	6330	*1 MA_Metal Loop 1-1	4/4	4	260	●		Real Drums Kit
Dr/Pc	Rock	6331	*1 MA_Metal Loop 1-2	4/4	4	170	●		:
Dr/Pc	Rock	6332	*1 MA_Metal Loop 1-3	4/4	4	260	●		:
Dr/Pc	Rock	6333	*1 MA_Metal Loop 2	4/4	4	146	●		:
Dr/Pc	Rock	6334	*1 MA_Metal Loop 3	4/4	4	152	●		Rock Stereo Kit 1
Dr/Pc	Rock	6335	*1 MA_Metal Loop 4	4/4	4	85	●		Modern Rock Kit
Dr/Pc	Rock	6336	*1 MA_Metal Loop 5-1	4/4	4	93	●		Real Drums Kit
Dr/Pc	Rock	6337	*1 MA_Metal Loop 5-2	4/4	4	94	●		:
Dr/Pc	Rock	6338	*1 MA_Metal Loop 6	4/4	4	128	●		Modern Rock Kit
Dr/Pc	Rock	6339	*1 MA_Metal Loop 7	4/4	4	145	●		Rock Stereo Kit 1
Dr/Pc	Rock	6340	MA_StandardRock	4/4	4	131	●		Power Standard Kit 2
Dr/Pc	Rock	6341	MB_StandardRock	4/4	4	131	●		:
Dr/Pc	Rock	6342	MC_StandardRock	4/4	4	131	●		:
Dr/Pc	Rock	6343	FA_StandardRock	4/4	1	131	●		:
Dr/Pc	Rock	6344	FB_StandardRock	4/4	1	131	●		:
Dr/Pc	Rock	6345	FC_StandardRock	4/4	1	131	●		:
Dr/Pc	Rock	6346	BA_StandardRock	4/4	1	131	●		:
Dr/Pc	Rock	6347	EA_StandardRock	4/4	4	131	●		:
Dr/Pc	Rock	6348	EB_StandardRock	4/4	6	131	●		:
Dr/Pc	Rock	6349	MA_Power Rock	4/4	4	120	●		Power Standard Kit 1

Main Category	Sub Category	ARP No.	ARP Name	Time Signature	Length	Original Tempo	Accent	Random SFX	Sound Type
Dr/Pc	Rock	6350	MB_Power Rock	4/4	4	120	●		:
Dr/Pc	Rock	6351	MC_Power Rock	4/4	4	120	●		:
Dr/Pc	Rock	6352	FA_Power Rock	4/4	1	120	●		:
Dr/Pc	Rock	6353	FB_Power Rock	4/4	1	120	●		:
Dr/Pc	Rock	6354	FC_Power Rock	4/4	1	120	●		:
Dr/Pc	Rock	6355	BA_Power Rock	4/4	1	120	●		:
Dr/Pc	Rock	6356	EA_Power Rock	4/4	4	120	●		:
Dr/Pc	Rock	6357	EB_Power Rock	4/4	7	120	●		:
Dr/Pc	Rock	6358	MA_ContempRock	4/4	4	126	●		Power Standard Kit 2
Dr/Pc	Rock	6359	MB_ContempRock	4/4	4	126	●		:
Dr/Pc	Rock	6360	MC_ContempRock	4/4	4	126	●		:
Dr/Pc	Rock	6361	FA_ContempRock	4/4	1	126	●		:
Dr/Pc	Rock	6362	FB_ContempRock	4/4	1	126	●		:
Dr/Pc	Rock	6363	FC_ContempRock	4/4	1	126	●		:
Dr/Pc	Rock	6364	BA_ContempRock	4/4	1	126	●		:
Dr/Pc	Rock	6365	EA_ContempRock	4/4	4	126	●		:
Dr/Pc	Rock	6366	EB_ContempRock	4/4	4	126	●		:
Dr/Pc	Rock	6367	MA_Hard Rock	4/4	4	120	●		Power Standard Kit 1
Dr/Pc	Rock	6368	MB_Hard Rock	4/4	4	120	●		:
Dr/Pc	Rock	6369	MC_Hard Rock	4/4	4	120	●		:
Dr/Pc	Rock	6370	FA_Hard Rock	4/4	1	120	●		:
Dr/Pc	Rock	6371	FB_Hard Rock	4/4	1	120	●		:
Dr/Pc	Rock	6372	FC_Hard Rock	4/4	1	120	●		:
Dr/Pc	Rock	6373	BA_Hard Rock	4/4	1	120	●		:
Dr/Pc	Rock	6374	EA_Hard Rock	4/4	3	120	●		:
Dr/Pc	Rock	6375	EB_Hard Rock	4/4	6	120	●		:
Dr/Pc	Rock	6376	MA_70s Rock	4/4	4	130	●		Dry Standard Kit
Dr/Pc	Rock	6377	MB_70s Rock	4/4	4	130	●		:
Dr/Pc	Rock	6378	MC_70s Rock	4/4	4	130	●		:
Dr/Pc	Rock	6379	MA_70s Rock	4/4	4	130	●		:
Dr/Pc	Rock	6380	IA_70s Rock	4/4	1	130	●		:
Dr/Pc	Rock	6381	FA_70s Rock	4/4	1	130	●		:
Dr/Pc	Rock	6382	FB_70s Rock	4/4	1	130	●		:
Dr/Pc	Rock	6383	FC_70s Rock	4/4	2	130	●		:
Dr/Pc	Rock	6384	MA_Blues Rock	4/4	4	120	●		Power Standard Kit 1
Dr/Pc	Rock	6385	MB_Blues Rock	4/4	4	120	●		:
Dr/Pc	Rock	6386	MC_Blues Rock	4/4	4	120	●		:
Dr/Pc	Rock	6387	FA_Blues Rock	4/4	1	120	●		:
Dr/Pc	Rock	6388	FB_Blues Rock	4/4	1	120	●		:
Dr/Pc	Rock	6389	FC_Blues Rock	4/4	1	120	●		:
Dr/Pc	Rock	6390	BA_Blues Rock	4/4	1	120	●		:
Dr/Pc	Rock	6391	EA_Blues Rock	4/4	3	120	●		:
Dr/Pc	Rock	6392	EB_Blues Rock	4/4	5	120	●		:
Dr/Pc	Rock	6393	MA_RockShuffle	4/4	4	121	●		Power Standard Kit 2
Dr/Pc	Rock	6394	MB_RockShuffle	4/4	4	121	●		:
Dr/Pc	Rock	6395	MC_RockShuffle	4/4	4	121	●		:
Dr/Pc	Rock	6396	FA_RockShuffle	4/4	1	121	●		:
Dr/Pc	Rock	6397	FB_RockShuffle	4/4	1	121	●		:
Dr/Pc	Rock	6398	FC_RockShuffle	4/4	1	121	●		:
Dr/Pc	Rock	6399	BA_RockShuffle	4/4	1	121	●		:
Dr/Pc	Rock	6400	EA_RockShuffle	4/4	6	121	●		:
Dr/Pc	Rock	6401	MA_Rock & Roll	4/4	4	172	●		:
Dr/Pc	Rock	6402	MB_Rock & Roll	4/4	4	172	●		:
Dr/Pc	Rock	6403	MC_Rock & Roll	4/4	4	172	●		:
Dr/Pc	Rock	6404	FA_Rock & Roll	4/4	1	172	●		:
Dr/Pc	Rock	6405	FB_Rock & Roll	4/4	1	172	●		:
Dr/Pc	Rock	6406	FC_Rock & Roll	4/4	1	172	●		:
Dr/Pc	Rock	6407	BA_Rock & Roll	4/4	1	172	●		:
Dr/Pc	Rock	6408	EA_Rock & Roll	4/4	5	172	●		:
Dr/Pc	Rock	6409	EB_Rock & Roll	4/4	6	172	●		:
Dr/Pc	Rock	6410	MA_AlternaRock1	4/4	4	97	●		Modern Rock Kit
Dr/Pc	Rock	6411	MB1_AlternaRock1	4/4	4	97	●		:
Dr/Pc	Rock	6412	MC1_AlternaRock1	4/4	4	97	●		:
Dr/Pc	Rock	6413	FA1_AlternaRock1	4/4	1	97	●		:
Dr/Pc	Rock	6414	FB1_AlternaRock1	4/4	1	97	●		:
Dr/Pc	Rock	6415	FC1_AlternaRock1	4/4	1	97	●		:
Dr/Pc	Rock	6416	BA1_AlternaRock1	4/4	1	97	●		:
Dr/Pc	Rock	6417	MA2_8Z Alterna1	4/4	4	97	●		8Z Romps
Dr/Pc	Rock	6418	MB2_8Z Alterna1	4/4	4	97	●		:
Dr/Pc	Rock	6419	MC2_8Z Alterna1	4/4	4	97	●		:
Dr/Pc	Rock	6420	FA2_8Z Alterna1	4/4	1	97	●		:
Dr/Pc	Rock	6421	FB2_8Z Alterna1	4/4	1	97	●		:
Dr/Pc	Rock	6422	FC2_8Z Alterna1						

Arpeggio Type List

Main Category	Sub Category	ARP No.	ARP Name	Time Signature	Length	Original Tempo	Accent	Random SFX	Sound Type
Dr/Pc	Rock	6437	MC1_Xover Rock	4/4	2	100	●		:
Dr/Pc	Rock	6438	MD1_Xover Rock	4/4	2	100	●		:
Dr/Pc	Rock	6439	IA1_Xover Rock	4/4	2	100	●		:
Dr/Pc	Rock	6440	FA1_Xover Rock	4/4	1	100	●		:
Dr/Pc	Rock	6441	FB1_Xover Rock	4/4	1	100	●		:
Dr/Pc	Rock	6442	FC1_Xover Rock	4/4	2	100	●		:
Dr/Pc	Rock	6443	MA_8Beat Rock	4/4	1	75	●		Power Standard Kit 2
Dr/Pc	Rock	6444	MB_8Beat Rock	4/4	4	75	●		:
Dr/Pc	Rock	6445	MC_8Beat Rock	4/4	4	75	●		:
Dr/Pc	Rock	6446	FA_8Beat Rock	4/4	1	75	●		:
Dr/Pc	Rock	6447	FB_8Beat Rock	4/4	1	75	●		:
Dr/Pc	Rock	6448	FC_8Beat Rock	4/4	1	75	●		:
Dr/Pc	Rock	6449	BA_8Beat Rock	4/4	1	75	●		:
Dr/Pc	Rock	6450	MA_16Beat Rock	4/4	4	86	●		Rock Stereo Kit 2
Dr/Pc	Rock	6451	MB_16Beat Rock	4/4	4	86	●		:
Dr/Pc	Rock	6452	MC_16Beat Rock	4/4	4	86	●		:
Dr/Pc	Rock	6453	FA_16Beat Rock	4/4	1	86	●		:
Dr/Pc	Rock	6454	FB_16Beat Rock	4/4	1	86	●		:
Dr/Pc	Rock	6455	FC_16Beat Rock	4/4	1	86	●		:
Dr/Pc	Rock	6456	BA_16Beat Rock	4/4	1	86	●		:
Dr/Pc	Rock	6457	MA_ProgresRock1	4/4	4	110	●		Modern Rock Kit
Dr/Pc	Rock	6458	MB_ProgresRock1	4/4	3	110	●		:
Dr/Pc	Rock	6459	MC_ProgresRock1	4/4	4	110	●		:
Dr/Pc	Rock	6460	FA_ProgresRock1	4/4	1	110	●		:
Dr/Pc	Rock	6461	FB_ProgresRock1	4/4	1	110	●		:
Dr/Pc	Rock	6462	FC_ProgresRock1	4/4	1	110	●		:
Dr/Pc	Rock	6463	BA_ProgresRock1	4/4	1	110	●		:
Dr/Pc	Rock	6464	MA_ProgresRock2	4/4	4	120	●		Power Standard Kit 2
Dr/Pc	Rock	6465	MB_ProgresRock2	4/4	4	120	●		:
Dr/Pc	Rock	6466	MC_ProgresRock2	4/4	4	120	●		:
Dr/Pc	Rock	6467	FA_ProgresRock2	4/4	1	120	●		:
Dr/Pc	Rock	6468	FB_ProgresRock2	4/4	1	120	●		:
Dr/Pc	Rock	6469	FC_ProgresRock2	4/4	1	120	●		:
Dr/Pc	Rock	6470	BA_ProgresRock2	4/4	1	120	●		:
Dr/Pc	Rock	6471	MA_Maple Custom	4/4	4	150	●		MapleCustom Kit
Dr/Pc	Rock	6472	MB_Maple Custom	4/4	2	150	●		:
Dr/Pc	Rock	6473	MC_Maple Custom	4/4	4	150	●		:
Dr/Pc	Rock	6474	MD_Maple Custom	4/4	4	150	●		:
Dr/Pc	Rock	6475	FA_Maple Custom	4/4	2	150	●		:
Dr/Pc	Rock	6476	BA_Maple Custom	4/4	2	150	●		:
Dr/Pc	Rock	6477	EA_Maple Custom	4/4	7	150	●		:
Dr/Pc	Rock	6478	MA_Rock Ready	4/4	4	160	●		Rock Stereo Kit 1
Dr/Pc	Pop Rock	6479	MA_8Beat Medium	4/4	4	105	●		Hyper Standard Kit
Dr/Pc	Pop Rock	6480	MB_8Beat Medium	4/4	4	105	●		:
Dr/Pc	Pop Rock	6481	MC_8Beat Medium	4/4	4	105	●		:
Dr/Pc	Pop Rock	6482	MD_8Beat Medium	4/4	4	105	●		:
Dr/Pc	Pop Rock	6483	FA_8Beat Medium	4/4	1	105	●		:
Dr/Pc	Pop Rock	6484	FB_8Beat Medium	4/4	1	105	●		:
Dr/Pc	Pop Rock	6485	FC_8Beat Medium	4/4	1	105	●		:
Dr/Pc	Pop Rock	6486	FD_8Beat Medium	4/4	1	105	●		:
Dr/Pc	Pop Rock	6487	EA_8Beat Medium	4/4	4	105	●		:
Dr/Pc	Pop Rock	6488	MA_8Beat Fast	4/4	4	140	●		Dry Standard Kit
Dr/Pc	Pop Rock	6489	MB_8Beat Fast	4/4	4	140	●		:
Dr/Pc	Pop Rock	6490	MC_8Beat Fast	4/4	4	140	●		:
Dr/Pc	Pop Rock	6491	MD_8Beat Fast	4/4	4	140	●		:
Dr/Pc	Pop Rock	6492	FA_8Beat Fast	4/4	1	140	●		:
Dr/Pc	Pop Rock	6493	FB_8Beat Fast	4/4	1	140	●		:
Dr/Pc	Pop Rock	6494	FC_8Beat Fast	4/4	1	140	●		:
Dr/Pc	Pop Rock	6495	FD_8Beat Fast	4/4	1	140	●		:
Dr/Pc	Pop Rock	6496	EA_8Beat Fast	4/4	5	140	●		:
Dr/Pc	Pop Rock	6497	MA_16Beat Medium	4/4	4	96	●		:
Dr/Pc	Pop Rock	6498	MB_16Beat Medium	4/4	4	96	●		:
Dr/Pc	Pop Rock	6499	MC_16Beat Medium	4/4	4	96	●		:
Dr/Pc	Pop Rock	6500	MD_16Beat Medium	4/4	4	96	●		:
Dr/Pc	Pop Rock	6501	FA_16Beat Medium	4/4	1	96	●		:
Dr/Pc	Pop Rock	6502	FB_16Beat Medium	4/4	1	96	●		:
Dr/Pc	Pop Rock	6503	FC_16Beat Medium	4/4	1	96	●		:
Dr/Pc	Pop Rock	6504	FD_16Beat Medium	4/4	1	96	●		:
Dr/Pc	Pop Rock	6505	EA_16Beat Medium	4/4	4	96	●		:
Dr/Pc	Pop Rock	6506	MA_GuitarPop Med	4/4	4	98	●		Brush Kit
Dr/Pc	Pop Rock	6507	MB_GuitarPop Med	4/4	4	98	●		:
Dr/Pc	Pop Rock	6508	MC_GuitarPop Med	4/4	4	98	●		:
Dr/Pc	Pop Rock	6509	MD_GuitarPop Med	4/4	4	98	●		:
Dr/Pc	Pop Rock	6510	FA_GuitarPop Med	4/4	1	98	●		:
Dr/Pc	Pop Rock	6511	FB_GuitarPop Med	4/4	1	98	●		:
Dr/Pc	Pop Rock	6512	FC_GuitarPop Med	4/4	1	98	●		:
Dr/Pc	Pop Rock	6513	FD_GuitarPop Med	4/4	1	98	●		:
Dr/Pc	Pop Rock	6514	EA_GuitarPop Med	4/4	3	98	●		:
Dr/Pc	Pop Rock	6515	MA_Pop Shuffle1	4/4	4	180	●		Power Standard Kit 1
Dr/Pc	Pop Rock	6516	MB_Pop Shuffle1	4/4	4	180	●		:
Dr/Pc	Pop Rock	6517	MC_Pop Shuffle1	4/4	4	180	●		:
Dr/Pc	Pop Rock	6518	MD_Pop Shuffle1	4/4	4	180	●		:
Dr/Pc	Pop Rock	6519	FA_Pop Shuffle1	4/4	1	180	●		:
Dr/Pc	Pop Rock	6520	FB_Pop Shuffle1	4/4	1	180	●		:
Dr/Pc	Pop Rock	6521	FC_Pop Shuffle1	4/4	1	180	●		:
Dr/Pc	Pop Rock	6522	FD_Pop Shuffle1	4/4	1	180	●		:
Dr/Pc	Pop Rock	6523	EA_Pop Shuffle1	4/4	5	180	●		:

Main Category	Sub Category	ARP No.	ARP Name	Time Signature	Length	Original Tempo	Accent	Random SFX	Sound Type
Dr/Pc	Pop Rock	6524	MA_Swing MOR Pop	4/4	4	94	●		Dry Standard Kit
Dr/Pc	Pop Rock	6525	MB_Swing MOR Pop	4/4	4	94	●		:
Dr/Pc	Pop Rock	6526	MC_Swing MOR Pop	4/4	4	94	●		:
Dr/Pc	Pop Rock	6527	MD_Swing MOR Pop	4/4	4	94	●		:
Dr/Pc	Pop Rock	6528	FA_Swing MOR Pop	4/4	1	94	●		:
Dr/Pc	Pop Rock	6529	FB_Swing MOR Pop	4/4	1	94	●		:
Dr/Pc	Pop Rock	6530	FC_Swing MOR Pop	4/4	1	94	●		:
Dr/Pc	Pop Rock	6531	FD_Swing MOR Pop	4/4	1	94	●		:
Dr/Pc	Pop Rock	6532	EA_Swing MOR Pop	4/4	3	94	●		:
Dr/Pc	Pop Rock	6533	MA_12/8 Pop	6/4	4	90	●		Hyper Standard Kit
Dr/Pc	Pop Rock	6534	MB_12/8 Pop	6/4	4	90	●		:
Dr/Pc	Pop Rock	6535	MC_12/8 Pop	6/4	4	90	●		:
Dr/Pc	Pop Rock	6536	MD_12/8 Pop	6/4	4	90	●		:
Dr/Pc	Pop Rock	6537	FA_12/8 Pop	6/4	1	90	●		:
Dr/Pc	Pop Rock	6538	FB_12/8 Pop	6/4	1	90	●		:
Dr/Pc	Pop Rock	6539	FC_12/8 Pop	6/4	1	90	●		:
Dr/Pc	Pop Rock	6540	FD_12/8 Pop	6/4	1	90	●		:
Dr/Pc	Pop Rock	6541	EA_12/8 Pop	6/4	4	90	●		:
Dr/Pc	Pop Rock	6542	MA_Country 8Beat	4/4	4	82	●		Brush Kit
Dr/Pc	Pop Rock	6543	MB_Country 8Beat	4/4	4	82	●		:
Dr/Pc	Pop Rock	6544	MC_Country 8Beat	4/4	4	82	●		:
Dr/Pc	Pop Rock	6545	MD_Country 8Beat	4/4	4	82	●		:
Dr/Pc	Pop Rock	6546	FA_Country 8Beat	4/4	1	82	●		:
Dr/Pc	Pop Rock	6547	FB_Country 8Beat	4/4	1	82	●		:
Dr/Pc	Pop Rock	6548	FC_Country 8Beat	4/4	1	82	●		:
Dr/Pc	Pop Rock	6549	FD_Country 8Beat	4/4	1	82	●		:
Dr/Pc	Pop Rock	6550	EA_Country 8Beat	4/4	3	82	●		:
Dr/Pc	Pop Rock	6551	MA_Country Swing	4/4	4	182	●		Power Standard Kit 1
Dr/Pc	Pop Rock	6552	MB_Country Swing	4/4	4	182	●		:
Dr/Pc	Pop Rock	6553	MC_Country Swing	4/4	4	182	●		:
Dr/Pc	Pop Rock	6554	MD_Country Swing	4/4	4	182	●		:
Dr/Pc	Pop Rock	6555	FA_Country Swing	4/4	1	182	●		:
Dr/Pc	Pop Rock	6556	FB_Country Swing	4/4	1	182	●		:
Dr/Pc	Pop Rock	6557	FC_Country Swing	4/4	1	182	●		:
Dr/Pc	Pop Rock	6558	FD_Country Swing	4/4	1	182	●		:
Dr/Pc	Pop Rock	6559	EA_Country Swing	4/4	5	182	●		:
Dr/Pc	Pop Rock	6560	MA_Country Waltz	3/4	4	144	●		Brush Kit
Dr/Pc	Pop Rock	6561	MB_Country Waltz	3/4	4	144	●		:
Dr/Pc	Pop Rock	6562	MC_Country Waltz	3/4	4	144	●		:
Dr/Pc	Pop Rock	6563	MD_Country Waltz	3/4	4	144	●		:
Dr/Pc	Pop Rock	6564	FA_Country Waltz	3/4	1	144	●		:
Dr/Pc	Pop Rock	6565	FB_Country Waltz	3/4	1	144	●		:
Dr/Pc	Pop Rock	6566	FC_Country Waltz	3/4	1	144	●		:
Dr/Pc	Pop Rock	6567	FD_Country Waltz	3/4	1	144	●		:
Dr/Pc	Pop Rock	6568	EA_Country Waltz	3/4	5	144	●		:
Dr/Pc	Pop Rock	6569	MA_Pop Rock 1	4/4	2	120	●		Rock Stereo Kit 2
Dr/Pc	Pop Rock	6570	MB_Pop Rock 1	4/4	2	120	●		:
Dr/Pc	Pop Rock	6571	MC_Pop Rock 1	4/4	2	120	●		:
Dr/Pc	Pop Rock	6572	MD_Pop Rock 1	4/4	2	120	●		:
Dr/Pc	Pop Rock	6573	FA_Pop Rock 2	4/4	2	126	●		Rock Stereo Kit 1
Dr/Pc	Pop Rock	6574	MB_Pop Rock 2	4/4	2	126	●		:
Dr/Pc	Pop Rock	6575	MC_Pop Rock 2	4/4	2	126	●		:
Dr/Pc	Pop Rock	6576	MD_Pop Rock 2	4/4	2	126	●		:
Dr/Pc	Pop Rock	6577	MA_Pop Rock 3	4/4	2	120	●		Rock Stereo Kit 2
Dr/Pc	Pop Rock	6578	MB_Pop Rock 3	4/4	2	115	●		:
Dr/Pc	Pop Rock	6579	MA_Guitar Pop 1	4/4	4	100	●		Power Standard Kit 1
Dr/Pc	Pop Rock	6580	MB_Guitar Pop 1	4/4	4	100	●		:
Dr/Pc	Pop Rock	6581	MC_Guitar Pop 1	4/4	4	100	●		:
Dr/Pc	Pop Rock	6582	FA_Guitar Pop 1	4/4	1	100	●		:
Dr/Pc	Pop Rock	6583	FB_Guitar Pop 1	4/4	1	100	●		:
Dr/Pc	Pop Rock	6584	FC_Guitar Pop 1	4/4	1	100	●		:
Dr/Pc	Pop Rock	6585	BA_Guitar Pop 1	4/4	1	100	●		:
Dr/Pc	Pop Rock	6586	EA_Guitar Pop 1	4/4	3	100	●		:
Dr/Pc	Pop Rock	6587	EB_Guitar Pop 1	4/4	3	100	●		:
Dr/Pc	Pop Rock	6588	MA1_Guitar Pop 2	4/4	2	90	●		Dry Standard Kit
Dr/Pc	Pop Rock	6589	MB1_Guitar Pop 2	4/4	1	90	●		:
Dr/Pc	Pop Rock	6590	MC1_Guitar Pop 2	4/4	2	90	●		:
Dr/Pc	Pop Rock	6591	MD1_Guitar Pop 2	4/4	2	90	●		:
Dr/Pc	Pop Rock	6592	IA1_Guitar Pop 2	4/4	2	90	●		:
Dr/Pc	Pop Rock	6593	FA1_Guitar Pop 2	4/4	1	90	●		:
Dr/Pc	Pop Rock	6594	FB1_Guitar Pop 2	4/4	1	90	●		:
Dr/Pc	Pop Rock	6595	FC1_Guitar Pop 2	4/4	2	90	●		:
Dr/Pc	Pop Rock	6596	MC2_Guitar Pop 2	4/4	2	90	●		Latin Percussion Kit
Dr/Pc	Pop Rock								

Main Category	Sub Category	ARP No.	ARP Name	Time Signature	Length	Original Tempo	Accent	Random SFX	Sound Type
Dr/Pc	Pop Rock	6611	IA_FingerPickin/a	4/4	1	94	●		:
Dr/Pc	Pop Rock	6612	IA_FingerPickin/b	4/4	1	94	●		:
Dr/Pc	Pop Rock	6613	FA_FingerPickin	4/4	1	94	●		:
Dr/Pc	Pop Rock	6614	FB_FingerPickin	4/4	1	94	●		:
Dr/Pc	Pop Rock	6615	FC_FingerPickin	4/4	1	94	●		:
Dr/Pc	Pop Rock	6616	MA_Folk Rock	4/4	1	120	●		:
Dr/Pc	Pop Rock	6617	MB_Folk Rock/1	4/4	4	120	●		:
Dr/Pc	Pop Rock	6618	MD_Folk Rock	4/4	1	120	●		:
Dr/Pc	Pop Rock	6619	IA_Folk Rock	4/4	1	120	●		:
Dr/Pc	Pop Rock	6620	FA_Folk Rock	4/4	1	120	●		:
Dr/Pc	Pop Rock	6621	FB_Folk Rock	4/4	1	120	●		:
Dr/Pc	Pop Rock	6622	FC_Folk Rock	4/4	1	120	●		:
Dr/Pc	Pop Rock	6623	MB_Folk Rock/2	4/4	1	120	●		:
Dr/Pc	Pop Rock	6624	MA_Worship Slow	4/4	4	75	●		Power Standard Kit 1
Dr/Pc	Pop Rock	6625	MB_Worship Slow	4/4	4	75	●		:
Dr/Pc	Pop Rock	6626	MC_Worship Slow	4/4	4	75	●		:
Dr/Pc	Pop Rock	6627	FA_Worship Slow	4/4	1	75	●		:
Dr/Pc	Pop Rock	6628	FB_Worship Slow	4/4	1	75	●		:
Dr/Pc	Pop Rock	6629	FC_Worship Slow	4/4	1	75	●		:
Dr/Pc	Pop Rock	6630	BA_Worship Slow	4/4	1	75	●		:
Dr/Pc	Pop Rock	6631	EA_Worship Slow	4/4	4	75	●		:
Dr/Pc	Pop Rock	6632	EB_Worship Slow	4/4	4	75	●		:
Dr/Pc	Pop Rock	6633	MA_Worship Med	4/4	8	140	●		Brush Kit
Dr/Pc	Pop Rock	6634	MB_Worship Med	4/4	4	140	●		:
Dr/Pc	Pop Rock	6635	MC_Worship Med	4/4	4	140	●		:
Dr/Pc	Pop Rock	6636	FA_Worship Med	4/4	1	140	●		:
Dr/Pc	Pop Rock	6637	FB_Worship Med	4/4	1	140	●		:
Dr/Pc	Pop Rock	6638	FC_Worship Med	4/4	1	140	●		:
Dr/Pc	Pop Rock	6639	BA_Worship Med	4/4	1	140	●		:
Dr/Pc	Pop Rock	6640	EA_Worship Med	4/4	4	140	●		:
Dr/Pc	Pop Rock	6641	EB_Worship Med	4/4	4	140	●		:
Dr/Pc	Pop Rock	6642	MA_Worship Fast	4/4	8	114	●		Power Standard Kit 2
Dr/Pc	Pop Rock	6643	MB_Worship Fast	4/4	4	114	●		:
Dr/Pc	Pop Rock	6644	MC_Worship Fast	4/4	4	114	●		:
Dr/Pc	Pop Rock	6645	FA_Worship Fast	4/4	1	114	●		:
Dr/Pc	Pop Rock	6646	FB_Worship Fast	4/4	1	114	●		:
Dr/Pc	Pop Rock	6647	FC_Worship Fast	4/4	1	114	●		:
Dr/Pc	Pop Rock	6648	BA_Worship Fast	4/4	1	114	●		:
Dr/Pc	Pop Rock	6649	EA_Worship Fast	4/4	4	114	●		:
Dr/Pc	Pop Rock	6650	EB_Worship Fast	4/4	2	114	●		:
Dr/Pc	Pop Rock	6651	MA_New Country	4/4	2	118	●		Power Standard Kit 1
Dr/Pc	Pop Rock	6652	MB_New Country	4/4	4	118	●		:
Dr/Pc	Pop Rock	6653	MC_New Country	4/4	2	118	●		:
Dr/Pc	Pop Rock	6654	FA_New Country	4/4	1	118	●		:
Dr/Pc	Pop Rock	6655	FB_New Country	4/4	1	118	●		:
Dr/Pc	Pop Rock	6656	FC_New Country	4/4	1	118	●		:
Dr/Pc	Pop Rock	6657	BA_New Country	4/4	1	118	●		:
Dr/Pc	Pop Rock	6658	EA_New Country	4/4	4	118	●		:
Dr/Pc	Pop Rock	6659	EB_New Country	4/4	4	118	●		:
Dr/Pc	Pop Rock	6660	MA_VintageGIPop	4/4	4	148	●		:
Dr/Pc	Pop Rock	6661	MB_VintageGIPop	4/4	4	148	●		:
Dr/Pc	Pop Rock	6662	MC_VintageGIPop	4/4	4	148	●		:
Dr/Pc	Pop Rock	6663	FA_VintageGIPop	4/4	1	148	●		:
Dr/Pc	Pop Rock	6664	FB_VintageGIPop	4/4	1	148	●		:
Dr/Pc	Pop Rock	6665	FC_VintageGIPop	4/4	1	148	●		:
Dr/Pc	Pop Rock	6666	BA_VintageGIPop	4/4	1	148	●		:
Dr/Pc	Pop Rock	6667	EA_VintageGIPop	4/4	4	148	●		:
Dr/Pc	Pop Rock	6668	EB_VintageGIPop	4/4	4	148	●		:
Dr/Pc	Pop Rock	6669	MA_WestCoastPop	4/4	4	100	●		:
Dr/Pc	Pop Rock	6670	MB_WestCoastPop	4/4	4	100	●		:
Dr/Pc	Pop Rock	6671	MC_WestCoastPop	4/4	4	100	●		:
Dr/Pc	Pop Rock	6672	FA_WestCoastPop	4/4	1	100	●		:
Dr/Pc	Pop Rock	6673	FB_WestCoastPop	4/4	1	100	●		:
Dr/Pc	Pop Rock	6674	FC_WestCoastPop	4/4	1	100	●		:
Dr/Pc	Pop Rock	6675	BA_WestCoastPop	4/4	1	100	●		:
Dr/Pc	Pop Rock	6676	EA_WestCoastPop	4/4	4	100	●		:
Dr/Pc	Pop Rock	6677	EB_WestCoastPop	4/4	4	100	●		:
Dr/Pc	Pop Rock	6678	MA_Brit Pop	4/4	2	86	●		Brush Kit
Dr/Pc	Pop Rock	6679	MB_Brit Pop	4/4	2	86	●		:
Dr/Pc	Pop Rock	6680	MC_Brit Pop	4/4	2	86	●		:
Dr/Pc	Pop Rock	6681	FA_Brit Pop	4/4	1	86	●		:
Dr/Pc	Pop Rock	6682	FB_Brit Pop	4/4	1	86	●		:
Dr/Pc	Pop Rock	6683	FC_Brit Pop	4/4	1	86	●		:
Dr/Pc	Pop Rock	6684	BA_Brit Pop	4/4	1	86	●		:
Dr/Pc	Pop Rock	6685	EA_Brit Pop	4/4	4	86	●		:
Dr/Pc	Pop Rock	6686	EB_Brit Pop	4/4	4	86	●		:
Dr/Pc	Pop Rock	6687	MA_BritPopSwing	4/4	2	110	●		Power Standard Kit 1
Dr/Pc	Pop Rock	6688	MB_BritPopSwing	4/4	2	110	●		:
Dr/Pc	Pop Rock	6689	MC_BritPopSwing	4/4	2	110	●		:
Dr/Pc	Pop Rock	6690	FA_BritPopSwing	4/4	1	110	●		:
Dr/Pc	Pop Rock	6691	FB_BritPopSwing	4/4	1	110	●		:
Dr/Pc	Pop Rock	6692	FC_BritPopSwing	4/4	1	110	●		:
Dr/Pc	Pop Rock	6693	BA_BritPopSwing	4/4	1	110	●		:
Dr/Pc	Pop Rock	6694	EA_BritPopSwing	4/4	4	110	●		:
Dr/Pc	Pop Rock	6695	EB_BritPopSwing	4/4	4	110	●		:
Dr/Pc	Pop Rock	6696	MA_Cool 8Beat	4/4	2	100	●		:
Dr/Pc	Pop Rock	6697	MB_Cool 8Beat	4/4	2	100	●		:

Main Category	Sub Category	ARP No.	ARP Name	Time Signature	Length	Original Tempo	Accent	Random SFX	Sound Type
Dr/Pc	Pop Rock	6698	MC_Cool 8Beat	4/4	2	100	●		:
Dr/Pc	Pop Rock	6699	FA_Cool 8Beat	4/4	1	100	●		:
Dr/Pc	Pop Rock	6700	FB_Cool 8Beat	4/4	1	100	●		:
Dr/Pc	Pop Rock	6701	FC_Cool 8Beat	4/4	1	100	●		:
Dr/Pc	Pop Rock	6702	BA_Cool 8Beat	4/4	1	100	●		:
Dr/Pc	Pop Rock	6703	EA_Cool 8Beat	4/4	4	100	●		:
Dr/Pc	Pop Rock	6704	EB_Cool 8Beat	4/4	4	100	●		:
Dr/Pc	Pop Rock	6705	MA_8Beat Basic	4/4	4	120	●		:
Dr/Pc	Pop Rock	6706	MB_8Beat Basic	4/4	4	120	●		:
Dr/Pc	Pop Rock	6707	MC_8Beat Basic	4/4	4	120	●		:
Dr/Pc	Pop Rock	6708	FA_8Beat Basic	4/4	1	120	●		:
Dr/Pc	Pop Rock	6709	FB_8Beat Basic	4/4	1	120	●		:
Dr/Pc	Pop Rock	6710	FC_8Beat Basic	4/4	1	120	●		:
Dr/Pc	Pop Rock	6711	BA_8Beat Basic	4/4	1	120	●		:
Dr/Pc	Pop Rock	6712	MA_8Beat Soft	4/4	4	100	●		:
Dr/Pc	Pop Rock	6713	MB_8Beat Soft	4/4	4	100	●		:
Dr/Pc	Pop Rock	6714	MC_8Beat Soft	4/4	4	100	●		:
Dr/Pc	Pop Rock	6715	FA_8Beat Soft	4/4	1	100	●		:
Dr/Pc	Pop Rock	6716	FB_8Beat Soft	4/4	1	100	●		:
Dr/Pc	Pop Rock	6717	FC_8Beat Soft	4/4	1	100	●		:
Dr/Pc	Pop Rock	6718	BA_8Beat Soft	4/4	1	100	●		:
Dr/Pc	Pop Rock	6719	MA_Soft Rock	4/4	4	120	●		Dry Standard Kit
Dr/Pc	Pop Rock	6720	MB_Soft Rock	4/4	4	120	●		:
Dr/Pc	Pop Rock	6721	MC_Soft Rock	4/4	4	120	●		:
Dr/Pc	Pop Rock	6722	MD_Soft Rock	4/4	4	120	●		:
Dr/Pc	Pop Rock	6723	IA_Soft Rock	4/4	1	120	●		:
Dr/Pc	Pop Rock	6724	FA_Soft Rock	4/4	1	120	●		:
Dr/Pc	Pop Rock	6725	FB_Soft Rock	4/4	1	120	●		:
Dr/Pc	Pop Rock	6726	FC_Soft Rock	4/4	1	120	●		:
Dr/Pc	Pop Rock	6727	MA_BritRockPop	4/4	4	123	●		Power Standard Kit 1
Dr/Pc	Pop Rock	6728	MB_BritRockPop	4/4	4	123	●		:
Dr/Pc	Pop Rock	6729	MC_BritRockPop	4/4	4	123	●		:
Dr/Pc	Pop Rock	6730	FA_BritRockPop	4/4	1	123	●		:
Dr/Pc	Pop Rock	6731	FB_BritRockPop	4/4	1	123	●		:
Dr/Pc	Pop Rock	6732	FC_BritRockPop	4/4	1	123	●		:
Dr/Pc	Pop Rock	6733	BA_BritRockPop	4/4	1	123	●		:
Dr/Pc	Pop Rock	6734	EA_BritRockPop	4/4	6	123	●		:
Dr/Pc	Pop Rock	6735	MA_80sPopRock	4/4	4	111	●		Rock Stereo Kit 2
Dr/Pc	Pop Rock	6736	MB_80sPopRock	4/4	4	111	●		:
Dr/Pc	Pop Rock	6737	MC_80sPopRock	4/4	4	111	●		:
Dr/Pc	Pop Rock	6738	FA_80sPopRock	4/4	1	111	●		:
Dr/Pc	Pop Rock	6739	FB_80sPopRock	4/4	1	111	●		:
Dr/Pc	Pop Rock	6740	FC_80sPopRock	4/4	1	111	●		:
Dr/Pc	Pop Rock	6741	BA_80sPopRock	4/4	1	111	●		:
Dr/Pc	Pop Rock	6742	EA_80sPopRock	4/4	7	111	●		:
Dr/Pc	Pop Rock	6743	MA_80sSynthRock	4/4	4	96	●		Modern Rock Kit
Dr/Pc	Pop Rock	6744	MB_80sSynthRock	4/4	4	96	●		:
Dr/Pc	Pop Rock	6745	MC_80sSynthRock	4/4	8	96	●		:
Dr/Pc	Pop Rock	6746	FA_80sSynthRock	4/4	1	96	●		:
Dr/Pc	Pop Rock	6747	FB_80sSynthRock	4/4	1	96	●		:
Dr/Pc	Pop Rock	6748	FC_80sSynthRock	4/4	1	96	●		:
Dr/Pc	Pop Rock	6749	BA_80sSynthRock	4/4	1	96	●		:
Dr/Pc	Pop Rock	6750	EA_80sSynthRock	4/4	3	96	●		:
Dr/Pc	Pop Rock	6751	MA_60sVintagePop	4/4	4	132	●		Jazz Kit
Dr/Pc	Pop Rock	6752	MB_60sVintagePop	4/4	4	132	●		:
Dr/Pc	Pop Rock	6753	MC_60sVintagePop	4/4	4	132	●		:
Dr/Pc	Pop Rock	6754	FA_60sVintagePop	4/4	1	132	●		:
Dr/Pc	Pop Rock	6755	FB_60sVintagePop	4/4	1	132	●		:
Dr/Pc	Pop Rock	6756	FC_60sVintagePop	4/4	1	132	●		:
Dr/Pc	Pop Rock	6757	BA_60sVintagePop	4/4	1	132	●		:
Dr/Pc	Pop Rock	6758	EA_60sVintagePop	4/4	2	132	●		:
Dr/Pc	Pop Rock	6759	MA_60sChartSwing	4/4	4	123	●		Power Standard Kit 1
Dr/Pc	Pop Rock	6760	MB_60sChartSwing	4/4	4	123	●		:
Dr/Pc	Pop Rock	6761	MC_60sChartSwing	4/4	4	123	●		:
Dr/Pc	Pop Rock	6762	FA_60sChartSwing	4/4	1	123	●		:
Dr/Pc	Pop Rock	6763	FB_60sChartSwing	4/4	1	123	●		:
Dr/Pc	Pop Rock	6764	FC_60sChartSwing	4/4	1	123	●		:
Dr/Pc	Pop Rock	6765	BA_60sChartSwing	4/4	1	123	●		:
Dr/Pc	Pop Rock	6766	EA_60sChartSwing	4/4	4	123	●		:
Dr/Pc	Pop Rock	6767	MA_16BeatBasic1	4/4	4	90	●		:
Dr/Pc	Pop Rock	6768	MB_16BeatBasic1	4/4	4	90	●		:
Dr/Pc	Pop Rock	6769	MC_16BeatBasic1	4/4	4	90	●		:
Dr/Pc	Pop Rock	6770	FA_16BeatBasic1	4/4					

Arpeggio Type List

Main Category	Sub Category	ARP No.	ARP Name	Time Signature	Length	Original Tempo	Accent	Random SFX	Sound Type
Dr/Pc	Pop Rock	6785	FB_16Beat Pop 1	4 / 4	1	103	●		:
Dr/Pc	Pop Rock	6786	FC_16Beat Pop 1	4 / 4	1	103	●		:
Dr/Pc	Pop Rock	6787	BA_16Beat Pop 1	4 / 4	1	103	●		:
Dr/Pc	Pop Rock	6788	MA_16Beat Pop 2	4 / 4	4	94	●		Analog T8 Kit
Dr/Pc	Pop Rock	6789	MB_16Beat Pop 2	4 / 4	4	94	●		:
Dr/Pc	Pop Rock	6790	MC_16Beat Pop 2	4 / 4	4	94	●		:
Dr/Pc	Pop Rock	6791	FA_16Beat Pop 2	4 / 4	1	94	●		:
Dr/Pc	Pop Rock	6792	FB_16Beat Pop 2	4 / 4	1	94	●		:
Dr/Pc	Pop Rock	6793	FC_16Beat Pop 2	4 / 4	1	94	●		:
Dr/Pc	Pop Rock	6794	BA_16Beat Pop 2	4 / 4	1	94	●		:
Dr/Pc	Pop Rock	6795	MA_Piano Club	4 / 4	2	96	●		Hyper Standard Kit
Dr/Pc	Pop Rock	6796	MB_Piano Club	4 / 4	2	96	●		:
Dr/Pc	Pop Rock	6797	MC_Piano Club	4 / 4	2	96	●		:
Dr/Pc	Pop Rock	6798	MD_Piano Club	4 / 4	2	96	●		:
Dr/Pc	Pop Rock	6799	IA_Piano Club/a	4 / 4	2	96	●		:
Dr/Pc	Pop Rock	6800	IA_Piano Club/b	4 / 4	2	96	●		:
Dr/Pc	Pop Rock	6801	FA_Piano Club	4 / 4	1	96	●		:
Dr/Pc	Pop Rock	6802	FB_Piano Club	4 / 4	1	96	●		:
Dr/Pc	Pop Rock	6803	FC_Piano Club/a	4 / 4	2	96	●		:
Dr/Pc	Pop Rock	6804	FC_Piano Club/b	4 / 4	1	96	●		:
Dr/Pc	Pop Rock	6805	MA_Analog Pop	4 / 4	2	93	●		Analog T8 Kit
Dr/Pc	Pop Rock	6806	MB_Analog Pop	4 / 4	2	93	●		:
Dr/Pc	Pop Rock	6807	MC_Analog Pop	4 / 4	2	93	●		:
Dr/Pc	Pop Rock	6808	MD_Analog Pop	4 / 4	4	93	●		:
Dr/Pc	Pop Rock	6809	IA_Analog Pop	4 / 4	2	93	●		:
Dr/Pc	Pop Rock	6810	FA_Analog Pop	4 / 4	1	93	●		:
Dr/Pc	Pop Rock	6811	FB_Analog Pop	4 / 4	1	93	●		:
Dr/Pc	Pop Rock	6812	FC_Analog Pop	4 / 4	2	93	●		:
Dr/Pc	Pop Rock	6813	MA1_Psycho Beatz	4 / 4	4	94	●		Psychedelic Kit
Dr/Pc	Pop Rock	6814	MA2_Psycho Beatz	4 / 4	4	94	●		:
Dr/Pc	Pop Rock	6815	MA3_Psycho Beatz	4 / 4	1	94	●		:
Dr/Pc	Pop Rock	6816	MB1_Psycho Beatz	4 / 4	4	94	●		:
Dr/Pc	Pop Rock	6817	MB2_Psycho Beatz	4 / 4	4	94	●		:
Dr/Pc	Pop Rock	6818	MB3_Psycho Beatz	4 / 4	1	94	●		:
Dr/Pc	Pop Rock	6819	MB4_Psycho Beatz	4 / 4	1	94	●		:
Dr/Pc	Pop Rock	6820	MC1_Psycho Beatz	4 / 4	2	94	●		:
Dr/Pc	Pop Rock	6821	MC2_Psycho Beatz	4 / 4	2	94	●		:
Dr/Pc	Pop Rock	6822	MC3_Psycho Beatz	4 / 4	4	94	●		:
Dr/Pc	Pop Rock	6823	MC4_Psycho Beatz	4 / 4	4	94	●		:
Dr/Pc	Pop Rock	6824	MD1_Psycho Beatz	4 / 4	4	94	●		:
Dr/Pc	Pop Rock	6825	MD2_Psycho Beatz	4 / 4	4	94	●		:
Dr/Pc	Pop Rock	6826	MD3_Psycho Beatz	4 / 4	4	94	●		:
Dr/Pc	Pop Rock	6827	MD4_Psycho Beatz	4 / 4	4	94	●		:
Dr/Pc	Pop Rock	6828	ME1_Psycho Beatz	4 / 4	4	94	●		:
Dr/Pc	Pop Rock	6829	ME2_Psycho Beatz	4 / 4	4	94	●		:
Dr/Pc	Pop Rock	6830	ME3_Psycho Beatz	4 / 4	4	94	●		:
Dr/Pc	Pop Rock	6831	ME4_Psycho Beatz	4 / 4	4	94	●		:
Dr/Pc	Pop Rock	6832	MA_8Z RX11	4 / 4	1	140	●		8Z RX11
Dr/Pc	Pop Rock	6833	MB_8Z RX11	4 / 4	1	140	●		:
Dr/Pc	Pop Rock	6834	MC_8Z RX11	4 / 4	2	140	●		:
Dr/Pc	Pop Rock	6835	FA_8Z RX11	4 / 4	1	140	●		:
Dr/Pc	Pop Rock	6836	FB_8Z RX11	4 / 4	1	140	●		:
Dr/Pc	Pop Rock	6837	EA_8Z RX11	4 / 4	3	140	●		:
Dr/Pc	Pop Rock	6838	MA_6/8 Pop	4 / 4	4	100	●		Power Standard Kit 1
Dr/Pc	Pop Rock	6839	MB_6/8 Pop	4 / 4	4	100	●		:
Dr/Pc	Pop Rock	6840	MC_6/8 Pop	4 / 4	4	100	●		:
Dr/Pc	Pop Rock	6841	FA_6/8 Pop	4 / 4	1	100	●		:
Dr/Pc	Pop Rock	6842	FB_6/8 Pop	4 / 4	1	100	●		:
Dr/Pc	Pop Rock	6843	FC_6/8 Pop	4 / 4	1	100	●		:
Dr/Pc	Pop Rock	6844	BA_6/8 Pop	4 / 4	1	100	●		:
Dr/Pc	Pop Rock	6845	EA_6/8 Pop	4 / 4	3	123	●		:
Dr/Pc	Pop Rock	6846	*1 MA_Crazy Girl	4 / 4	4	100	●		Dancefloor Kit
Dr/Pc	Pop Rock	6847	*1 MB_Crazy Girl	4 / 4	4	100	●		:
Dr/Pc	Pop Rock	6848	*1 MC_Crazy Girl	4 / 4	4	100	●		:
Dr/Pc	Pop Rock	6849	*1 MD_Crazy Girl	4 / 4	4	100	●		:
Dr/Pc	Pop Rock	6850	*1 MA_Pop Loop 1	4 / 4	4	125	●		D'elo Kit
Dr/Pc	Pop Rock	6851	*1 MA_Pop Loop 2	4 / 4	4	129	●		T's EDM Kit
Dr/Pc	Ballad	6852	MA_8Beat Ballad1	4 / 4	4	103	●		Dry Standard Kit
Dr/Pc	Ballad	6853	MB_8Beat Ballad1	4 / 4	4	103	●		:
Dr/Pc	Ballad	6854	MC_8Beat Ballad1	4 / 4	4	103	●		:
Dr/Pc	Ballad	6855	MD_8Beat Ballad1	4 / 4	4	103	●		:
Dr/Pc	Ballad	6856	FA_8Beat Ballad1	4 / 4	1	103	●		:
Dr/Pc	Ballad	6857	FB_8Beat Ballad1	4 / 4	1	103	●		:
Dr/Pc	Ballad	6858	FC_8Beat Ballad1	4 / 4	1	103	●		:
Dr/Pc	Ballad	6859	FD_8Beat Ballad1	4 / 4	1	103	●		:
Dr/Pc	Ballad	6860	EA_8Beat Ballad1	4 / 4	4	103	●		:
Dr/Pc	Ballad	6861	MA_16Bt Ballad1	4 / 4	4	59	●		Hyper Standard Kit
Dr/Pc	Ballad	6862	MB_16Bt Ballad1	4 / 4	4	59	●		:
Dr/Pc	Ballad	6863	MC_16Bt Ballad1	4 / 4	4	59	●		:
Dr/Pc	Ballad	6864	MD_16Bt Ballad1	4 / 4	4	59	●		:
Dr/Pc	Ballad	6865	FA_16Bt Ballad1	4 / 4	1	59	●		:
Dr/Pc	Ballad	6866	FB_16Bt Ballad1	4 / 4	1	59	●		:
Dr/Pc	Ballad	6867	FC_16Bt Ballad1	4 / 4	1	59	●		:
Dr/Pc	Ballad	6868	FD_16Bt Ballad1	4 / 4	1	59	●		:
Dr/Pc	Ballad	6869	EA_16Bt Ballad1	4 / 4	3	59	●		:
Dr/Pc	Ballad	6870	MA_12/8 Ballad	4 / 4	4	60	●		Power Standard Kit 1
Dr/Pc	Ballad	6871	MB_12/8 Ballad	4 / 4	4	60	●		:

Main Category	Sub Category	ARP No.	ARP Name	Time Signature	Length	Original Tempo	Accent	Random SFX	Sound Type
Dr/Pc	Ballad	6872	MC_12/8 Ballad	4 / 4	4	60	●		:
Dr/Pc	Ballad	6873	MD_12/8 Ballad	4 / 4	4	60	●		:
Dr/Pc	Ballad	6874	FA_12/8 Ballad	4 / 4	1	60	●		:
Dr/Pc	Ballad	6875	FB_12/8 Ballad	4 / 4	1	60	●		:
Dr/Pc	Ballad	6876	FC_12/8 Ballad	4 / 4	1	60	●		:
Dr/Pc	Ballad	6877	FD_12/8 Ballad	4 / 4	1	60	●		:
Dr/Pc	Ballad	6878	EA_12/8 Ballad	4 / 4	3	60	●		:
Dr/Pc	Ballad	6879	MA_Country Ballad	4 / 4	4	75	●		Brush Kit
Dr/Pc	Ballad	6880	MB_Country Ballad	4 / 4	4	75	●		:
Dr/Pc	Ballad	6881	MC_Country Ballad	4 / 4	4	75	●		:
Dr/Pc	Ballad	6882	MD_Country Ballad	4 / 4	4	75	●		:
Dr/Pc	Ballad	6883	FA_Country Ballad	4 / 4	1	75	●		:
Dr/Pc	Ballad	6884	FB_Country Ballad	4 / 4	1	75	●		:
Dr/Pc	Ballad	6885	FC_Country Ballad	4 / 4	1	75	●		:
Dr/Pc	Ballad	6886	FD_Country Ballad	4 / 4	1	75	●		:
Dr/Pc	Ballad	6887	EA_Country Ballad	4 / 4	3	75	●		:
Dr/Pc	Ballad	6888	MA_AnthemRkBlid	4 / 4	4	72	●		Hyper Standard Kit
Dr/Pc	Ballad	6889	MB_AnthemRkBlid	4 / 4	4	72	●		:
Dr/Pc	Ballad	6890	MC_AnthemRkBlid	4 / 4	4	72	●		:
Dr/Pc	Ballad	6891	MD_AnthemRkBlid	4 / 4	4	72	●		:
Dr/Pc	Ballad	6892	FA_AnthemRkBlid	4 / 4	1	72	●		:
Dr/Pc	Ballad	6893	FB_AnthemRkBlid	4 / 4	1	72	●		:
Dr/Pc	Ballad	6894	FC_AnthemRkBlid	4 / 4	1	72	●		:
Dr/Pc	Ballad	6895	FD_AnthemRkBlid	4 / 4	1	72	●		:
Dr/Pc	Ballad	6896	EA_AnthemRkBlid	4 / 4	3	72	●		:
Dr/Pc	Ballad	6897	MA_Eclectic Bld	4 / 4	4	84	●		Arabic Mixed Kit 1
Dr/Pc	Ballad	6898	MB_Eclectic Bld	4 / 4	4	84	●		:
Dr/Pc	Ballad	6899	MC_Eclectic Bld	4 / 4	4	84	●		:
Dr/Pc	Ballad	6900	MD_Eclectic Bld	4 / 4	4	84	●		:
Dr/Pc	Ballad	6901	FA_Eclectic Bld	4 / 4	1	84	●		:
Dr/Pc	Ballad	6902	FB_Eclectic Bld	4 / 4	1	84	●		:
Dr/Pc	Ballad	6903	FC_Eclectic Bld	4 / 4	1	84	●		:
Dr/Pc	Ballad	6904	FD_Eclectic Bld	4 / 4	1	84	●		:
Dr/Pc	Ballad	6905	EA_Eclectic Bld	4 / 4	4	84	●		:
Dr/Pc	Ballad	6906	MA_GuitarBallad	4 / 4	8	94	●		Power Standard Kit 1
Dr/Pc	Ballad	6907	MB_GuitarBallad	4 / 4	8	94	●		:
Dr/Pc	Ballad	6908	MC_GuitarBallad	4 / 4	8	94	●		:
Dr/Pc	Ballad	6909	FA_GuitarBallad	4 / 4	1	94	●		:
Dr/Pc	Ballad	6910	FB_GuitarBallad	4 / 4	1	94	●		:
Dr/Pc	Ballad	6911	FC_GuitarBallad	4 / 4	1	94	●		:
Dr/Pc	Ballad	6912	BA_GuitarBallad	4 / 4	1	94	●		:
Dr/Pc	Ballad	6913	EA_GuitarBallad	4 / 4	4	94	●		:
Dr/Pc	Ballad	6914	EB_GuitarBallad	4 / 4	4	94	●		:
Dr/Pc	Ballad	6915	MA_Unplugged 1	4 / 4	4	120	●		:
Dr/Pc	Ballad	6916	MB_Unplugged 1	4 / 4	4	120	●		:
Dr/Pc	Ballad	6917	MC_Unplugged 1	4 / 4	4	120	●		:
Dr/Pc	Ballad	6918	FA_Unplugged 1	4 / 4	1	120	●		:
Dr/Pc	Ballad	6919	FB_Unplugged 1	4 / 4	1	120	●		:
Dr/Pc	Ballad	6920	FC_Unplugged 1	4 / 4	1	120	●		:
Dr/Pc	Ballad	6921	BA_Unplugged 1	4 / 4	1	120	●		:
Dr/Pc	Ballad	6922	MA1_Unplugged 2	4 / 4	8	120	●		:
Dr/Pc	Ballad	6923	MB1_Unplugged 2	4 / 4	8	120	●		:
Dr/Pc	Ballad	6924	MC1_Unplugged 2	4 / 4	8	120	●		:
Dr/Pc	Ballad	6925	FA1_Unplugged 2	4 / 4	1	120	●		:
Dr/Pc	Ballad	6926	FB1_Unplugged 2	4 / 4	1	120	●		:
Dr/Pc	Ballad	6927	FC1_Unplugged 2	4 / 4	1	120	●		:
Dr/Pc	Ballad	6928	BA1_Unplugged 2	4 / 4	1	120	●		:
Dr/Pc	Ballad	6929	MA2_Unplugged 2	4 / 4	8	120	●		:
Dr/Pc	Ballad	6930	MB2_Unplugged 2	4 / 4	8	120	●		:
Dr/Pc	Ballad	6931	MC2_Unplugged 2	4 / 4	8	120	●		:
Dr/Pc	Ballad	6932	FA2_Unplugged 2	4 / 4	1	120	●		:
Dr/Pc	Ballad	6933	FB2_Unplugged 2	4 / 4	1	120	●		:
Dr/Pc	Ballad	6934	FC2_Unplugged 2	4 / 4	1	120	●		:
Dr/Pc	Ballad	6935	BA2_Unplugged 2	4 / 4	1	120	●		:
Dr/Pc	Ballad	6936	EA1_Unplugged 2	4 / 4	5	120	●		:
Dr/Pc	Ballad	6937	EB1_Unplugged 2	4 / 4	4	120	●		:
Dr/Pc	Ballad	6938	MA_Unplugged 3	4 / 4	4	113	●		Power Standard Kit 2
Dr/Pc	Ballad	6939	MB_Unplugged 3	4 / 4	4	113	●		:
Dr/Pc	Ballad	6940	MC_Unplugged 3	4 / 4	4	113	●		:

Arpeggio Type List

Main Category	Sub Category	ARP No.	ARP Name	Time Signature	Length	Original Tempo	Accent	Random SFX	Sound Type
Dr/Pc	Ballad	6959	FB_8Beat Ballad2	4/4	1	101	●		:
Dr/Pc	Ballad	6960	FC_8Beat Ballad2	4/4	1	101	●		:
Dr/Pc	Ballad	6961	BA_8Beat Ballad2	4/4	1	101	●		:
Dr/Pc	Ballad	6962	EA_8Beat Ballad2	4/4	5	101	●		:
Dr/Pc	Ballad	6963	EB_8Beat Ballad2	4/4	5	101	●		:
Dr/Pc	Ballad	6964	MA_EP Ballad	4/4	2	60	●		Power Standard Kit 2
Dr/Pc	Ballad	6965	MB_EP Ballad	4/4	2	60	●		:
Dr/Pc	Ballad	6966	MC_EP Ballad	4/4	2	60	●		:
Dr/Pc	Ballad	6967	FA_EP Ballad	4/4	1	60	●		:
Dr/Pc	Ballad	6968	FB_EP Ballad	4/4	1	60	●		:
Dr/Pc	Ballad	6969	FC_EP Ballad	4/4	1	60	●		:
Dr/Pc	Ballad	6970	BA_EP Ballad	4/4	1	60	●		:
Dr/Pc	Ballad	6971	EA_EP Ballad	4/4	4	60	●		:
Dr/Pc	Ballad	6972	EB_EP Ballad	4/4	4	60	●		:
Dr/Pc	Ballad	6973	MA_Ballad 1	4/4	2	72	●		Hyper Standard Kit
Dr/Pc	Ballad	6974	MB_Ballad 1	4/4	2	72	●		:
Dr/Pc	Ballad	6975	MA_Ballad 2	4/4	2	72	●		:
Dr/Pc	Ballad	6976	MB_Ballad 2	4/4	2	72	●		:
Dr/Pc	Ballad	6977	MA_Ballad 3	4/4	2	72	●		:
Dr/Pc	Ballad	6978	MB_Ballad 3	4/4	1	72	●		:
Dr/Pc	Ballad	6979	MA_8Beat Slow	4/4	4	78	●		Power Standard Kit 2
Dr/Pc	Ballad	6980	MB_8Beat Slow	4/4	4	78	●		:
Dr/Pc	Ballad	6981	MC_8Beat Slow	4/4	4	78	●		:
Dr/Pc	Ballad	6982	FA_8Beat Slow	4/4	1	78	●		:
Dr/Pc	Ballad	6983	FB_8Beat Slow	4/4	1	78	●		:
Dr/Pc	Ballad	6984	FC_8Beat Slow	4/4	1	78	●		:
Dr/Pc	Ballad	6985	BA_8Beat Slow	4/4	1	78	●		:
Dr/Pc	Ballad	6986	MA_Slowfeel	4/4	1	74	●		Hyper Standard Kit
Dr/Pc	Ballad	6987	MB_Slowfeel	4/4	1	74	●		:
Dr/Pc	Ballad	6988	MC_Slowfeel	4/4	1	74	●		:
Dr/Pc	Ballad	6989	MD_Slowfeel	4/4	1	74	●		:
Dr/Pc	Ballad	6990	IA_Slowfeel	4/4	2	74	●		:
Dr/Pc	Ballad	6991	FA_Slowfeel	4/4	1	74	●		:
Dr/Pc	Ballad	6992	FB_Slowfeel	4/4	1	74	●		:
Dr/Pc	Ballad	6993	FC_Slowfeel	4/4	2	74	●		:
Dr/Pc	Ballad	6994	MA_16Bt Ballad2	4/4	4	75	●		Power Standard Kit 2
Dr/Pc	Ballad	6995	MB_16Bt Ballad2	4/4	4	75	●		:
Dr/Pc	Ballad	6996	MC_16Bt Ballad2	4/4	4	75	●		:
Dr/Pc	Ballad	6997	FA_16Bt Ballad2	4/4	1	75	●		:
Dr/Pc	Ballad	6998	FB_16Bt Ballad2	4/4	1	75	●		:
Dr/Pc	Ballad	6999	FC_16Bt Ballad2	4/4	1	75	●		:
Dr/Pc	Ballad	7000	BA_16Bt Ballad2	4/4	1	75	●		:
Dr/Pc	Ballad	7001	MA_16Bt Ballad3	4/4	2	64	●		Power Standard Kit 1
Dr/Pc	Ballad	7002	MB_16Bt Ballad3	4/4	2	64	●		:
Dr/Pc	Ballad	7003	MC_16Bt Ballad3	4/4	2	64	●		:
Dr/Pc	Ballad	7004	MD_16Bt Ballad3	4/4	2	64	●		:
Dr/Pc	Ballad	7005	ME_16Bt Ballad3	4/4	2	64	●		:
Dr/Pc	Ballad	7006	MF_16Bt Ballad3	4/4	2	64	●		:
Dr/Pc	Ballad	7007	BA_16Bt Ballad3	4/4	1	64	●		:
Dr/Pc	Ballad	7008	MA_ChiliKitPop1	4/4	2	85	●		Chili Out Kit
Dr/Pc	Ballad	7009	MA_ChiliKitPop2	4/4	2	85	●		:
Dr/Pc	Ballad	7010	MA_ChiliKitPop3	4/4	2	85	●		:
Dr/Pc	Ballad	7011	MA_ChiliKitPop4	4/4	2	85	●		:
Dr/Pc	Ballad	7012	MA_ChiliKitPop5	4/4	2	85	●		:
Dr/Pc	Ballad	7013	MA_ChIKiBallad1	4/4	2	90	●		:
Dr/Pc	Ballad	7014	MB_ChIKiBallad1	4/4	2	90	●		:
Dr/Pc	Ballad	7015	MA_ChIKiBallad2	4/4	2	90	●		:
Dr/Pc	Ballad	7016	MB_ChIKiBallad2	4/4	2	90	●		:
Dr/Pc	Ballad	7017	MA_ChIKiBallad3	4/4	2	90	●		:
Dr/Pc	Ballad	7018	MA_ChIKiBallad4	4/4	2	90	●		:
Dr/Pc	Ballad	7019	MA_ChIKiBallad5	4/4	2	90	●		:
Dr/Pc	Ballad	7020	MA_Nu Jazzy	4/4	2	61	●		Nu Jazzy Kit
Dr/Pc	Ballad	7021	MB_Nu Jazzy	4/4	2	61	●		:
Dr/Pc	Ballad	7022	MC_Nu Jazzy	4/4	2	61	●		:
Dr/Pc	Ballad	7023	FA_Nu Jazzy	4/4	1	61	●		:
Dr/Pc	Ballad	7024	EA_Nu Jazzy	4/4	4	61	●		:
Dr/Pc	Ballad	7025	MA_6/8 Ballad	6/8	4	87	●		Power Standard Kit 2
Dr/Pc	Ballad	7026	MB_6/8 Ballad	6/8	4	87	●		:
Dr/Pc	Ballad	7027	MC_6/8 Ballad	6/8	4	87	●		:
Dr/Pc	Ballad	7028	FA_6/8 Ballad	6/8	1	87	●		:
Dr/Pc	Ballad	7029	FB_6/8 Ballad	6/8	1	87	●		:
Dr/Pc	Ballad	7030	FC_6/8 Ballad	6/8	1	87	●		:
Dr/Pc	Ballad	7031	BA_6/8 Ballad	6/8	1	87	●		:
Dr/Pc	Ballad	7032	EA_6/8 Ballad	6/8	6	87	●		:
Dr/Pc	Ballad	7033	EB_6/8 Ballad	6/8	6	87	●		:
Dr/Pc	Ballad	7034	*1 MA_Pop Ballad	4/4	4	118	●		T's EDM Kit
Dr/Pc	Hip Hop	7035	*1 MA_Creepin	4/4	2	85	●		T's Hip Hop Kit
Dr/Pc	Hip Hop	7036	*1 MA_D Boy	4/4	4	92	●		:
Dr/Pc	Hip Hop	7037	*1 MB_D Boy	4/4	4	92	●		:
Dr/Pc	Hip Hop	7038	*1 MA_Figueroa	4/4	4	97	●		:
Dr/Pc	Hip Hop	7039	*1 MB_Figueroa	4/4	4	97	●		:
Dr/Pc	Hip Hop	7040	*1 MA_Purple Drink	4/4	4	92	●		:
Dr/Pc	Hip Hop	7041	*1 MB_Purple Drink	4/4	4	92	●		:
Dr/Pc	Hip Hop	7042	*1 MA_Champ	4/4	2	123	●		:
Dr/Pc	Hip Hop	7043	*1 MB_Champ	4/4	8	123	●		:
Dr/Pc	Hip Hop	7044	*1 MA_Old Money	4/4	4	126	●		:
Dr/Pc	Hip Hop	7045	*1 MB_Old Money	4/4	4	126	●		:

Main Category	Sub Category	ARP No.	ARP Name	Time Signature	Length	Original Tempo	Accent	Random SFX	Sound Type
Dr/Pc	Hip Hop	7046	*1 MA_Let's Get It	4/4	8	140	●		:
Dr/Pc	Hip Hop	7047	*1 MB_Let's Get It	4/4	8	140	●		:
Dr/Pc	Hip Hop	7048	*1 MA_On Tour	4/4	8	156	●		:
Dr/Pc	Hip Hop	7049	*1 MB_On Tour	4/4	8	156	●		:
Dr/Pc	Hip Hop	7050	*1 MA_Cookin Up	4/4	8	126	●		:
Dr/Pc	Hip Hop	7051	*1 MB_Cookin Up	4/4	8	126	●		:
Dr/Pc	Hip Hop	7052	*1 MA_Designer Belt	4/4	8	139	●		:
Dr/Pc	Hip Hop	7053	*1 MB_Designer Belt	4/4	4	139	●		:
Dr/Pc	Hip Hop	7054	*1 MA_Lydia	4/4	4	120	●		:
Dr/Pc	Hip Hop	7055	*1 MB_Lydia	4/4	4	120	●		:
Dr/Pc	Hip Hop	7056	*1 MA_Toyz R	4/4	8	146	●		:
Dr/Pc	Hip Hop	7057	*1 MA_Tank Top	4/4	8	139	●		:
Dr/Pc	Hip Hop	7058	*1 MA_Flower Swerve	4/4	2	87	●		:
Dr/Pc	Hip Hop	7059	*1 MA_One Time	4/4	4	107	●		:
Dr/Pc	Hip Hop	7060	*1 MA_Da Goose	4/4	4	130	●		Trap Kit
Dr/Pc	Hip Hop	7061	*1 MA_Mood Lighting	4/4	4	65	●		T's Hip Hop Kit
Dr/Pc	Hip Hop	7062	*1 MB_Mood Lighting	4/4	4	65	●		:
Dr/Pc	Hip Hop	7063	*1 MC_Mood Lighting	4/4	4	65	●		:
Dr/Pc	Hip Hop	7064	*1 MD_Mood Lighting	4/4	4	65	●		:
Dr/Pc	Hip Hop	7065	*1 MA_Energy Drink	4/4	4	83	●		Break Kit
Dr/Pc	Hip Hop	7066	*1 MB_Energy Drink	4/4	4	83	●		:
Dr/Pc	Hip Hop	7067	*1 MC_Energy Drink	4/4	4	83	●		:
Dr/Pc	Hip Hop	7068	*1 MD_Energy Drink	4/4	4	83	●		:
Dr/Pc	Hip Hop	7069	*1 MA_Big Beat Hip Hop	4/4	4	85	●		T's Hip Hop Kit
Dr/Pc	Hip Hop	7070	*1 MA_Nest	4/4	4	80	●		D'elo Kit
Dr/Pc	Hip Hop	7071	*1 MA_People	4/4	4	93	●		:
Dr/Pc	Hip Hop	7072	*1 MA_Soft Pants	4/4	4	165	●		:
Dr/Pc	Hip Hop	7073	*1 MA_Banana	4/4	4	160	●		T's Hip Hop Kit
Dr/Pc	Hip Hop	7074	*1 MA_Ruby Runner	4/4	4	150	●		:
Dr/Pc	Hip Hop	7075	*1 MB_Ruby Runner	4/4	4	150	●		:
Dr/Pc	Hip Hop	7076	*1 MA_No Love	4/4	4	130	●		HipHopMultipleKits
Dr/Pc	Hip Hop	7077	*1 MA_Cocoa Butter	4/4	4	150	●		:
Dr/Pc	Hip Hop	7078	*1 MA_What's Shakin	4/4	4	156	●		Trap Kit
Dr/Pc	Hip Hop	7079	*1 MB_What's Shakin	4/4	4	156	●		:
Dr/Pc	Hip Hop	7080	*1 MC_What's Shakin	4/4	4	156	●		:
Dr/Pc	Hip Hop	7081	*1 MD_What's Shakin	4/4	4	156	●		:
Dr/Pc	Hip Hop	7082	*1 MA_Destination	4/4	4	76	●		Downtempo HipHop Kit
Dr/Pc	Hip Hop	7083	*1 MB_Destination	4/4	4	76	●		:
Dr/Pc	Hip Hop	7084	*1 MC_Destination	4/4	4	76	●		:
Dr/Pc	Hip Hop	7085	*1 MD_Destination	4/4	4	76	●		:
Dr/Pc	Hip Hop	7086	*1 MA_The Jump	4/4	4	137	●		Trap Kit
Dr/Pc	Hip Hop	7087	*1 MA_Sub Mello	4/4	4	142	●		:
Dr/Pc	Hip Hop	7088	*1 MA_Bad Boy	4/4	4	93	●		DUB Kit
Dr/Pc	Hip Hop	7089	*1 MA_Bad Girl	4/4	4	93	●		:
Dr/Pc	Hip Hop	7090	*1 MA_Trap Loop 1	4/4	4	132	●		Trap Kit
Dr/Pc	Hip Hop	7091	*1 MA_Trap Loop 2	4/4	4	118	●		:
Dr/Pc	Hip Hop	7092	*1 MA_Trap Loop 3	4/4	4	119	●		:
Dr/Pc	Hip Hop	7093	*1 MA_Trap Loop 4	4/4	4	137	●		:
Dr/Pc	Hip Hop	7094	*1 MA_Clifford	4/4	4	160	●		EDM Kit
Dr/Pc	Hip Hop	7095	*1 MB_Clifford	4/4	4	160	●		:
Dr/Pc	Hip Hop	7096	*1 MA_Trigger	4/4	4	115	●		T's Hip Hop Kit
Dr/Pc	Hip Hop	7097	*1 MA_Sap	4/4	4	125	●		Trap Kit
Dr/Pc	Hip Hop	7098	*1 MA_Eye Shadow	4/4	4	100	●		:
Dr/Pc	Hip Hop	7099	*1 MA_A Strut	4/4	4	94	●		Electro Kit
Dr/Pc	Hip Hop	7100	*1 MA_Samurai	4/4	4	125	●		House-Techno Kit
Dr/Pc	Hip Hop	7101	*1 MA_Giggle	4/4	2	87	●		EDM Kit
Dr/Pc	Hip Hop	7102	*1 MA_Draw The Line	4/4	1	85	●		T's EDM Kit
Dr/Pc	Hip Hop	7103	*1 MA_Zodiac Sign	4/4	2	112	●		:
Dr/Pc	Hip Hop	7104	*1 MB_Zodiac Sign	4/4	2	112	●		:
Dr/Pc	Hip Hop	7105	*1 MA_Thy Self	4/4	4	96	●		Real Drums Kit
Dr/Pc	Hip Hop	7106	*1 MB_Thy Self	4/4	4	96	●		:
Dr/Pc	Hip Hop	7107	*1 MA_Cheer	4/4	4	90	●		Orchestra Kit
Dr/Pc	Hip Hop	7108	MA_Ain't My Fault	4/4	4	100	●		T's Hip Hop Kit
Dr/Pc	Hip Hop	7109	MA_All That Dough	4/4	4	142	●		:
Dr/Pc	Hip Hop	7110	MA_All The Way Up	4/4	4	164	●		:
Dr/Pc	Hip Hop	7111	MA_Big Buck	4/4	4	98	●		:
Dr/Pc	Hip Hop	7112	MA_Big Business	4/4	4	95	●		:
Dr/Pc	Hip Hop	7113	MA_Clap Up	4/4	4	94	●		:
Dr/Pc	Hip Hop	7114	MA_CPT Kidd	4/4	4	114	●		:
Dr/Pc	Hip Hop	7115	MA_Dr. Rubber	4/4	4	87	●		:
Dr/Pc	Hip Hop	7116	MA_Flexin	4/4	4	83	●		:
Dr/Pc	Hip Hop	7117	MA_Habbits	4/4	4	95	●		

Main Category	Sub Category	ARP No.	ARP Name	Time Signature	Length	Original Tempo	Accent	Random SFX	Sound Type
Dr/Pc	Hip Hop	7133	MA_Hopscotch	4/4	4	84	●		:
Dr/Pc	Hip Hop	7134	MA_Into The Wild	4/4	1	85	●		:
Dr/Pc	Hip Hop	7135	MA_Laid Back	4/4	2	85	●		:
Dr/Pc	Hip Hop	7136	MA_The Stomp	4/4	1	87	●		:
Dr/Pc	Hip Hop	7137	MA_Slide In	4/4	4	88	●		:
Dr/Pc	Hip Hop	7138	MA_Mack Ave	4/4	2	90	●		:
Dr/Pc	Hip Hop	7139	MA_Prospect	4/4	1	90	●		:
Dr/Pc	Hip Hop	7140	MA_The Thump	4/4	1	90	●		:
Dr/Pc	Hip Hop	7141	MA_90s Baby	4/4	1	90	●		:
Dr/Pc	Hip Hop	7142	MA_90s Girl	4/4	1	90	●		:
Dr/Pc	Hip Hop	7143	MA_Down Lo	4/4	1	92	●		:
Dr/Pc	Hip Hop	7144	MA_Down Lower	4/4	1	92	●		:
Dr/Pc	Hip Hop	7145	MA_Turn It Up	4/4	2	92	●		:
Dr/Pc	Hip Hop	7146	MA_Init Half On It	4/4	4	100	●		:
Dr/Pc	Hip Hop	7147	MA_Grassroots	4/4	2	105	●		:
Dr/Pc	Hip Hop	7148	MA_West Coast Money	4/4	1	110	●		:
Dr/Pc	Hip Hop	7149	MA_Darker Hits	4/4	4	135	●		:
Dr/Pc	Hip Hop	7150	MA_Freq License	4/4	2	135	●		:
Dr/Pc	Hip Hop	7151	MA_Hat Builder	4/4	1	135	●		:
Dr/Pc	Hip Hop	7152	MA_Look Future	4/4	4	135	●		:
Dr/Pc	Hip Hop	7153	MA_Sub Strength	4/4	4	135	●		:
Dr/Pc	Hip Hop	7154	MA_Trouble	4/4	2	140	●		:
Dr/Pc	Hip Hop	7155	MA_Up	4/4	2	140	●		:
Dr/Pc	Hip Hop	7156	MA_Fire Sauce	4/4	4	142	●		:
Dr/Pc	Hip Hop	7157	MA_Flossin Hard	4/4	4	142	●		:
Dr/Pc	Hip Hop	7158	MA_Up Subz	4/4	4	142	●		:
Dr/Pc	Hip Hop	7159	MA_Baking Soda	4/4	4	150	●		:
Dr/Pc	Hip Hop	7160	MA_Burner	4/4	4	150	●		:
Dr/Pc	Hip Hop	7161	MA_Riser	4/4	4	150	●		:
Dr/Pc	Hip Hop	7162	MA_Feetwerk	4/4	4	160	●		:
Dr/Pc	Hip Hop	7163	MA_Super Snare	4/4	4	160	●		:
Dr/Pc	Hip Hop	7164	MA_Cracked	4/4	4	160	●		:
Dr/Pc	Hip Hop	7165	MA_Snapper	4/4	2	160	●		:
Dr/Pc	Hip Hop	7166	MA_2BZ4U	4/4	4	75	●		Nu Hip Hop Kit 2
Dr/Pc	Hip Hop	7167	MB_2BZ4U	4/4	4	75	●		:
Dr/Pc	Hip Hop	7168	MC_2BZ4U	4/4	4	75	●		:
Dr/Pc	Hip Hop	7169	MD_2BZ4U	4/4	4	75	●		:
Dr/Pc	Hip Hop	7170	MA_Bklyn	4/4	4	89	●		Hip Hop Kit 1
Dr/Pc	Hip Hop	7171	MB_Bklyn	4/4	4	89	●		:
Dr/Pc	Hip Hop	7172	MC_Bklyn	4/4	4	89	●		:
Dr/Pc	Hip Hop	7173	MD_Bklyn	4/4	4	89	●		:
Dr/Pc	Hip Hop	7174	ME_Bklyn	4/4	4	89	●		:
Dr/Pc	Hip Hop	7175	MF_Bklyn	4/4	4	89	●		:
Dr/Pc	Hip Hop	7176	MA_DirtySynth	4/4	4	85	●		Analog T8 Kit
Dr/Pc	Hip Hop	7177	MB_DirtySynth	4/4	4	85	●		:
Dr/Pc	Hip Hop	7178	MC_DirtySynth	4/4	4	85	●		:
Dr/Pc	Hip Hop	7179	MA_PepRally	4/4	2	75	●		Nu Hip Hop Kit 1
Dr/Pc	Hip Hop	7180	MB_PepRally	4/4	2	75	●		:
Dr/Pc	Hip Hop	7181	MC_PepRally	4/4	2	75	●		:
Dr/Pc	Hip Hop	7182	MD_PepRally	4/4	2	75	●		:
Dr/Pc	Hip Hop	7183	ME_PepRally	4/4	2	75	●		:
Dr/Pc	Hip Hop	7184	MA_HipHopEpic /1	4/4	2	85	●		Hip Hop Kit 4
Dr/Pc	Hip Hop	7185	MA_HipHopEpic /2	4/4	2	85	●		:
Dr/Pc	Hip Hop	7186	MA_HipHopEpic /3	4/4	2	85	●		:
Dr/Pc	Hip Hop	7187	MB_HipHopEpic /1	4/4	2	85	●		:
Dr/Pc	Hip Hop	7188	MB_HipHopEpic /2	4/4	2	85	●		:
Dr/Pc	Hip Hop	7189	MB_HipHopEpic /3	4/4	2	85	●		:
Dr/Pc	Hip Hop	7190	MC_HipHopEpic /1	4/4	2	85	●		:
Dr/Pc	Hip Hop	7191	MC_HipHopEpic /2	4/4	2	85	●		:
Dr/Pc	Hip Hop	7192	MC_HipHopEpic /3	4/4	2	85	●		:
Dr/Pc	Hip Hop	7193	MA1_New Hip Hop	4/4	2	85	●		Power Standard Kit 1
Dr/Pc	Hip Hop	7194	MB1_New Hip Hop	4/4	2	85	●		:
Dr/Pc	Hip Hop	7195	MC1_New Hip Hop	4/4	2	85	●		:
Dr/Pc	Hip Hop	7196	FA1_New Hip Hop	4/4	1	85	●		:
Dr/Pc	Hip Hop	7197	FB1_New Hip Hop	4/4	1	85	●		:
Dr/Pc	Hip Hop	7198	FC1_New Hip Hop	4/4	1	85	●		:
Dr/Pc	Hip Hop	7199	BA1_New Hip Hop	4/4	1	85	●		:
Dr/Pc	Hip Hop	7200	EA1_New Hip Hop	4/4	3	85	●		:
Dr/Pc	Hip Hop	7201	EB1_New Hip Hop	4/4	3	85	●		:
Dr/Pc	Hip Hop	7202	MA2_New Hip Hop	4/4	2	85	●		Hip Hop Kit 2
Dr/Pc	Hip Hop	7203	MB2_New Hip Hop	4/4	2	85	●		:
Dr/Pc	Hip Hop	7204	MC2_New Hip Hop	4/4	2	85	●		:
Dr/Pc	Hip Hop	7205	FA2_New Hip Hop	4/4	1	85	●		:
Dr/Pc	Hip Hop	7206	FB2_New Hip Hop	4/4	1	85	●		:
Dr/Pc	Hip Hop	7207	FC2_New Hip Hop	4/4	1	85	●		:
Dr/Pc	Hip Hop	7208	BA2_New Hip Hop	4/4	1	85	●		:
Dr/Pc	Hip Hop	7209	EA2_New Hip Hop	4/4	3	85	●		:
Dr/Pc	Hip Hop	7210	EB2_New Hip Hop	4/4	3	85	●		:
Dr/Pc	Hip Hop	7211	MA_East Coast	4/4	2	103	●		Hip Hop Kit 1
Dr/Pc	Hip Hop	7212	MB_East Coast	4/4	2	103	●		:
Dr/Pc	Hip Hop	7213	MC_East Coast	4/4	2	103	●		:
Dr/Pc	Hip Hop	7214	MD_East Coast	4/4	2	103	●		:
Dr/Pc	Hip Hop	7215	FA_East Coast	4/4	1	103	●		:
Dr/Pc	Hip Hop	7216	FB_East Coast	4/4	1	103	●		:
Dr/Pc	Hip Hop	7217	FC_East Coast	4/4	1	103	●		:
Dr/Pc	Hip Hop	7218	FD_East Coast	4/4	1	103	●		:
Dr/Pc	Hip Hop	7219	MA1_West Coast	4/4	2	97	●		Hip Hop Kit 2

Main Category	Sub Category	ARP No.	ARP Name	Time Signature	Length	Original Tempo	Accent	Random SFX	Sound Type
Dr/Pc	Hip Hop	7220	MB1_West Coast	4/4	2	97	●		:
Dr/Pc	Hip Hop	7221	MC1_West Coast	4/4	2	97	●		:
Dr/Pc	Hip Hop	7222	MD1_West Coast	4/4	2	97	●		:
Dr/Pc	Hip Hop	7223	FA1_West Coast	4/4	1	97	●		:
Dr/Pc	Hip Hop	7224	FB1_West Coast	4/4	1	97	●		:
Dr/Pc	Hip Hop	7225	FC1_West Coast	4/4	1	97	●		:
Dr/Pc	Hip Hop	7226	FD1_West Coast	4/4	1	97	●		:
Dr/Pc	Hip Hop	7227	MA2_West Coast	4/4	2	97	●		Hip Hop Kit 1
Dr/Pc	Hip Hop	7228	MB2_West Coast	4/4	2	97	●		:
Dr/Pc	Hip Hop	7229	MC2_West Coast	4/4	2	97	●		:
Dr/Pc	Hip Hop	7230	MD2_West Coast	4/4	2	97	●		:
Dr/Pc	Hip Hop	7231	FA2_West Coast	4/4	1	97	●		:
Dr/Pc	Hip Hop	7232	FB2_West Coast	4/4	1	97	●		:
Dr/Pc	Hip Hop	7233	FC2_West Coast	4/4	1	97	●		:
Dr/Pc	Hip Hop	7234	FD2_West Coast	4/4	1	97	●		:
Dr/Pc	Hip Hop	7235	MA1_South Rap 1	4/4	4	98	●		Belly Dance Kit
Dr/Pc	Hip Hop	7236	MB1_South Rap 1	4/4	4	98	●		:
Dr/Pc	Hip Hop	7237	MC1_South Rap 1	4/4	4	98	●		:
Dr/Pc	Hip Hop	7238	MD1_South Rap 1	4/4	4	98	●		:
Dr/Pc	Hip Hop	7239	FA1_South Rap 1	4/4	1	98	●		:
Dr/Pc	Hip Hop	7240	FB1_South Rap 1	4/4	1	98	●		:
Dr/Pc	Hip Hop	7241	FC1_South Rap 1	4/4	1	98	●		:
Dr/Pc	Hip Hop	7242	FD1_South Rap 1	4/4	1	98	●		:
Dr/Pc	Hip Hop	7243	MA2_South Rap 1	4/4	4	98	●		Hip Hop Kit 1
Dr/Pc	Hip Hop	7244	MB2_South Rap 1	4/4	4	98	●		:
Dr/Pc	Hip Hop	7245	MC2_South Rap 1	4/4	4	98	●		:
Dr/Pc	Hip Hop	7246	MD2_South Rap 1	4/4	4	98	●		:
Dr/Pc	Hip Hop	7247	FA2_South Rap 1	4/4	1	98	●		:
Dr/Pc	Hip Hop	7248	FB2_South Rap 1	4/4	1	98	●		:
Dr/Pc	Hip Hop	7249	FC2_South Rap 1	4/4	1	98	●		:
Dr/Pc	Hip Hop	7250	FD2_South Rap 1	4/4	1	98	●		:
Dr/Pc	Hip Hop	7251	MB1_South Rap 2	4/4	2	90	●		Hip Hop Kit 2
Dr/Pc	Hip Hop	7252	MC1_South Rap 2	4/4	2	90	●		:
Dr/Pc	Hip Hop	7253	MD1_South Rap 2	4/4	2	90	●		:
Dr/Pc	Hip Hop	7254	FA1_South Rap 2	4/4	1	90	●		:
Dr/Pc	Hip Hop	7255	FB1_South Rap 2	4/4	1	90	●		:
Dr/Pc	Hip Hop	7256	FC1_South Rap 2	4/4	1	90	●		:
Dr/Pc	Hip Hop	7257	FD1_South Rap 2	4/4	1	90	●		:
Dr/Pc	Hip Hop	7258	MA2_South Rap 2	4/4	2	90	●		Hip Hop Kit 1
Dr/Pc	Hip Hop	7259	MB2_South Rap 2	4/4	2	90	●		:
Dr/Pc	Hip Hop	7260	MC2_South Rap 2	4/4	2	90	●		:
Dr/Pc	Hip Hop	7261	MD2_South Rap 2	4/4	2	90	●		:
Dr/Pc	Hip Hop	7262	FA2_South Rap 2	4/4	1	90	●		:
Dr/Pc	Hip Hop	7263	FB2_South Rap 2	4/4	1	90	●		:
Dr/Pc	Hip Hop	7264	FC2_South Rap 2	4/4	1	90	●		:
Dr/Pc	Hip Hop	7265	FD2_South Rap 2	4/4	1	90	●		:
Dr/Pc	Hip Hop	7266	MA_Hip Hop 1	4/4	2	105	●		Hip Hop Kit 3
Dr/Pc	Hip Hop	7267	MB_Hip Hop 1	4/4	2	105	●		:
Dr/Pc	Hip Hop	7268	MC_Hip Hop 1	4/4	2	105	●		:
Dr/Pc	Hip Hop	7269	MD_Hip Hop 1	4/4	2	105	●		:
Dr/Pc	Hip Hop	7270	IA_Hip Hop 1	4/4	1	105	●		:
Dr/Pc	Hip Hop	7271	FA_Hip Hop 1	4/4	1	105	●		:
Dr/Pc	Hip Hop	7272	FB_Hip Hop 1	4/4	1	105	●		:
Dr/Pc	Hip Hop	7273	FC_Hip Hop 1	4/4	2	105	●		:
Dr/Pc	Hip Hop	7274	MA_Hip Hop 2	4/4	2	104	●		:
Dr/Pc	Hip Hop	7275	MB_Hip Hop 2	4/4	2	104	●		:
Dr/Pc	Hip Hop	7276	MC_Hip Hop 2	4/4	2	104	●		:
Dr/Pc	Hip Hop	7277	MD_Hip Hop 2	4/4	2	104	●		:
Dr/Pc	Hip Hop	7278	IA_Hip Hop 2	4/4	1	104	●		:
Dr/Pc	Hip Hop	7279	FA_Hip Hop 2	4/4	1	104	●		:
Dr/Pc	Hip Hop	7280	FB_Hip Hop 2	4/4	1	104	●		:
Dr/Pc	Hip Hop	7281	FC_Hip Hop 2	4/4	2	104	●		:
Dr/Pc	Hip Hop	7282	MA_Hip Hop 3	4/4	2	94	●		Break Kit
Dr/Pc	Hip Hop	7283	MB_Hip Hop 3	4/4	2	94	●		:
Dr/Pc	Hip Hop	7284	MC_Hip Hop 3	4/4	2	94	●		:
Dr/Pc	Hip Hop	7285	MD_Hip Hop 3	4/4	2	94	●		:
Dr/Pc	Hip Hop	7286	IA_Hip Hop 3	4/4	2	94	●		:
Dr/Pc	Hip Hop	7287	FA_Hip Hop 3	4/4	1	94	●		:
Dr/Pc	Hip Hop	7288	FB_Hip Hop 3	4/4	1	94	●		:
Dr/Pc	Hip Hop	7289	FC_Hip Hop 3	4/4	2	94	●		:
Dr/Pc	Hip Hop	7290	MA_Hip Hop 4	4/4	2	96	●		Hip Hop Kit 1
Dr/Pc	Hip Hop	7291	MA1_Hip Hop 5	4/4	2	103	●		:
Dr/Pc	Hip Hop	7292	MB1_Hip Hop 5	4/4	4	103	●		:

Main Category	Sub Category	ARP No.	ARP Name	Time Signature	Length	Original Tempo	Accent	Random SFX	Sound Type
Dr/Pc	Hip Hop	7307	MA_Hip Hop 6	4 / 4	4	96	●		Hip Hop Kit 1
Dr/Pc	Hip Hop	7308	MB_Hip Hop 6	4 / 4	4	96	●		:
Dr/Pc	Hip Hop	7309	MC_Hip Hop 6	4 / 4	4	96	●		:
Dr/Pc	Hip Hop	7310	FA_Hip Hop 6	4 / 4	1	96	●		:
Dr/Pc	Hip Hop	7311	FB_Hip Hop 6	4 / 4	1	96	●		:
Dr/Pc	Hip Hop	7312	FC_Hip Hop 6	4 / 4	1	96	●		:
Dr/Pc	Hip Hop	7313	BA_Hip Hop 6	4 / 4	1	96	●		:
Dr/Pc	Hip Hop	7314	MA1_Hip Break	4 / 4	4	98	●		:
Dr/Pc	Hip Hop	7315	MB1_Hip Break	4 / 4	4	98	●		:
Dr/Pc	Hip Hop	7316	MC1_Hip Break	4 / 4	4	98	●		:
Dr/Pc	Hip Hop	7317	FA1_Hip Break	4 / 4	1	98	●		:
Dr/Pc	Hip Hop	7318	FB1_Hip Break	4 / 4	1	98	●		:
Dr/Pc	Hip Hop	7319	FC1_Hip Break	4 / 4	1	98	●		:
Dr/Pc	Hip Hop	7320	BA1_Hip Break	4 / 4	1	98	●		:
Dr/Pc	Hip Hop	7321	MA2_Hip Break	4 / 4	4	98	●		Break Kit
Dr/Pc	Hip Hop	7322	MB2_Hip Break	4 / 4	4	98	●		:
Dr/Pc	Hip Hop	7323	MC2_Hip Break	4 / 4	4	98	●		:
Dr/Pc	Hip Hop	7324	FA2_Hip Break	4 / 4	1	98	●		:
Dr/Pc	Hip Hop	7325	FB2_Hip Break	4 / 4	1	98	●		:
Dr/Pc	Hip Hop	7326	FC2_Hip Break	4 / 4	1	98	●		:
Dr/Pc	Hip Hop	7327	BA2_Hip Break	4 / 4	1	98	●		:
Dr/Pc	Hip Hop	7328	MA_Hip Rock 1	4 / 4	4	90	●		Rock Stereo Kit 2
Dr/Pc	Hip Hop	7329	MB_Hip Rock 1	4 / 4	4	90	●		:
Dr/Pc	Hip Hop	7330	MC_Hip Rock 1	4 / 4	4	90	●		:
Dr/Pc	Hip Hop	7331	FA_Hip Rock 1	4 / 4	1	90	●		:
Dr/Pc	Hip Hop	7332	FB_Hip Rock 1	4 / 4	1	90	●		:
Dr/Pc	Hip Hop	7333	FC_Hip Rock 1	4 / 4	1	90	●		:
Dr/Pc	Hip Hop	7334	BA_Hip Rock 1	4 / 4	1	90	●		:
Dr/Pc	Hip Hop	7335	MA_Hip Rock 2	4 / 4	4	132	●		House Kit 2
Dr/Pc	Hip Hop	7336	MB_Hip Rock 2	4 / 4	4	132	●		:
Dr/Pc	Hip Hop	7337	MC_Hip Rock 2	4 / 4	4	132	●		:
Dr/Pc	Hip Hop	7338	FA_Hip Rock 2	4 / 4	1	132	●		:
Dr/Pc	Hip Hop	7339	FB_Hip Rock 2	4 / 4	1	132	●		:
Dr/Pc	Hip Hop	7340	FC_Hip Rock 2	4 / 4	1	132	●		:
Dr/Pc	Hip Hop	7341	BA_Hip Rock 2	4 / 4	1	132	●		:
Dr/Pc	Hip Hop	7342	MA1_Hip Reggae	4 / 4	4	92	●		House Kit 1
Dr/Pc	Hip Hop	7343	MB1_Hip Reggae	4 / 4	4	92	●		:
Dr/Pc	Hip Hop	7344	MC1_Hip Reggae	4 / 4	4	92	●		:
Dr/Pc	Hip Hop	7345	FA1_Hip Reggae	4 / 4	1	92	●		:
Dr/Pc	Hip Hop	7346	FB1_Hip Reggae	4 / 4	1	92	●		:
Dr/Pc	Hip Hop	7347	FC1_Hip Reggae	4 / 4	1	92	●		:
Dr/Pc	Hip Hop	7348	BA1_Hip Reggae	4 / 4	1	92	●		:
Dr/Pc	Hip Hop	7349	MA2_Hip Reggae	4 / 4	4	92	●		Latin Percussion Kit
Dr/Pc	Hip Hop	7350	MB2_Hip Reggae	4 / 4	4	92	●		:
Dr/Pc	Hip Hop	7351	MC2_Hip Reggae	4 / 4	4	92	●		:
Dr/Pc	Hip Hop	7352	FA2_Hip Reggae	4 / 4	1	92	●		:
Dr/Pc	Hip Hop	7353	FB2_Hip Reggae	4 / 4	1	92	●		:
Dr/Pc	Hip Hop	7354	FC2_Hip Reggae	4 / 4	1	92	●		:
Dr/Pc	Hip Hop	7355	BA2_Hip Reggae	4 / 4	1	92	●		:
Dr/Pc	Hip Hop	7356	MA1_Regeton	4 / 4	4	98	●		Hip Hop Kit 1
Dr/Pc	Hip Hop	7357	MB1_Regeton	4 / 4	4	98	●		:
Dr/Pc	Hip Hop	7358	MC1_Regeton	4 / 4	4	98	●		:
Dr/Pc	Hip Hop	7359	FA1_Regeton	4 / 4	1	98	●		:
Dr/Pc	Hip Hop	7360	FB1_Regeton	4 / 4	1	98	●		:
Dr/Pc	Hip Hop	7361	FC1_Regeton	4 / 4	1	98	●		:
Dr/Pc	Hip Hop	7362	BA1_Regeton	4 / 4	1	98	●		:
Dr/Pc	Hip Hop	7363	MA2_Regeton	4 / 4	4	98	●		Percussion Kit
Dr/Pc	Hip Hop	7364	MB2_Regeton	4 / 4	4	98	●		:
Dr/Pc	Hip Hop	7365	MC2_Regeton	4 / 4	4	98	●		:
Dr/Pc	Hip Hop	7366	FA2_Regeton	4 / 4	1	98	●		:
Dr/Pc	Hip Hop	7367	FB2_Regeton	4 / 4	1	98	●		:
Dr/Pc	Hip Hop	7368	FC2_Regeton	4 / 4	1	98	●		:
Dr/Pc	Hip Hop	7369	BA2_Regeton	4 / 4	1	98	●		:
Dr/Pc	Hip Hop	7370	MA_Dancehall	4 / 4	4	103	●		Break Kit
Dr/Pc	Hip Hop	7371	MB_Dancehall	4 / 4	4	103	●		:
Dr/Pc	Hip Hop	7372	MD_Dancehall	4 / 4	4	103	●		:
Dr/Pc	Hip Hop	7373	FA_Dancehall	4 / 4	1	103	●		:
Dr/Pc	Hip Hop	7374	FB_Dancehall	4 / 4	1	103	●		:
Dr/Pc	Hip Hop	7375	FD_Dancehall	4 / 4	1	103	●		:
Dr/Pc	Hip Hop	7376	BA_Dancehall	4 / 4	1	103	●		:
Dr/Pc	Hip Hop	7377	EA_Dancehall	4 / 4	3	103	●		:
Dr/Pc	Hip Hop	7378	MA_Hip Ethnic 1	4 / 4	2	94	●		Hip Hop Kit 1
Dr/Pc	Hip Hop	7379	MB_Hip Ethnic 1	4 / 4	2	94	●		:
Dr/Pc	Hip Hop	7380	MC_Hip Ethnic 1	4 / 4	2	94	●		:
Dr/Pc	Hip Hop	7381	MD_Hip Ethnic 1	4 / 4	2	94	●		:
Dr/Pc	Hip Hop	7382	ME_Hip Ethnic 1	4 / 4	2	94	●		:
Dr/Pc	Hip Hop	7383	MF_Hip Ethnic 1	4 / 4	2	94	●		:
Dr/Pc	Hip Hop	7384	BA_Hip Ethnic 1	4 / 4	1	94	●		:
Dr/Pc	Hip Hop	7385	MA_Hip Ethnic 2	4 / 4	2	110	●		:
Dr/Pc	Hip Hop	7386	MB_Hip Ethnic 2	4 / 4	2	110	●		:
Dr/Pc	Hip Hop	7387	MC_Hip Ethnic 2	4 / 4	2	110	●		:
Dr/Pc	Hip Hop	7388	MD_Hip Ethnic 2	4 / 4	2	110	●		:
Dr/Pc	Hip Hop	7389	ME_Hip Ethnic 2	4 / 4	2	110	●		:
Dr/Pc	Hip Hop	7390	MF_Hip Ethnic 2	4 / 4	2	110	●		:
Dr/Pc	Hip Hop	7391	BA_Hip Ethnic 2	4 / 4	1	110	●		:
Dr/Pc	Hip Hop	7392	MA_ClasichipHop	4 / 4	2	90	●		Hip Hop Kit 3
Dr/Pc	Hip Hop	7393	MB_ClasichipHop	4 / 4	1	90	●		:

Main Category	Sub Category	ARP No.	ARP Name	Time Signature	Length	Original Tempo	Accent	Random SFX	Sound Type
Dr/Pc	Hip Hop	7394	MC_ClasichipHop	4 / 4	1	90	●		:
Dr/Pc	Hip Hop	7395	MD_ClasichipHop	4 / 4	2	90	●		:
Dr/Pc	Hip Hop	7396	IA_ClasichipHop/1a	4 / 4	2	90	●		:
Dr/Pc	Hip Hop	7397	IA_ClasichipHop/1b	4 / 4	1	90	●		:
Dr/Pc	Hip Hop	7398	FA_ClasichipHop	4 / 4	1	90	●		:
Dr/Pc	Hip Hop	7399	FB_ClasichipHop	4 / 4	1	90	●		:
Dr/Pc	Hip Hop	7400	IA_ClasichipHop/2	4 / 4	4	90	●		:
Dr/Pc	Hip Hop	7401	MA_I-Hop	4 / 4	4	98	●		:
Dr/Pc	Hip Hop	7402	MB_I-Hop	4 / 4	4	98	●		:
Dr/Pc	Hip Hop	7403	MC_I-Hop	4 / 4	4	98	●		:
Dr/Pc	Hip Hop	7404	MD_I-Hop	4 / 4	1	98	●		:
Dr/Pc	Hip Hop	7405	MA_Gangsta	4 / 4	2	98	●		Hip Hop Kit 4
Dr/Pc	Hip Hop	7406	MB_Gangsta	4 / 4	4	98	●		:
Dr/Pc	Hip Hop	7407	MC_Gangsta	4 / 4	4	98	●		:
Dr/Pc	Hip Hop	7408	MD_Gangsta	4 / 4	2	98	●		:
Dr/Pc	Hip Hop	7409	MA_Jazz Hop	4 / 4	2	106	●		Hip Hop Kit 2
Dr/Pc	Hip Hop	7410	MA_HipHop Loop1	4 / 4	4	97	●		Nu Hip Hop Kit 1
Dr/Pc	Hip Hop	7411	MA_HipHop Loop2	4 / 4	4	81	●		:
Dr/Pc	Hip Hop	7412	MA_HipHop Loop3	4 / 4	4	96	●		:
Dr/Pc	Hip Hop	7413	MA_HipHop Loop4	4 / 4	4	93	●		:
Dr/Pc	Hip Hop	7414	MA_HipHop Loop5	4 / 4	4	94	●		:
Dr/Pc	Hip Hop	7415	MA_HipHop Loop6	4 / 4	4	95	●		:
Dr/Pc	Hip Hop	7416	MA_HipHop Loop7	4 / 4	4	100	●		:
Dr/Pc	Hip Hop	7417	MA_HipHop Loop8	4 / 4	4	87	●		:
Dr/Pc	Hip Hop	7418	MA_HipHop Loop9	4 / 4	4	97	●		:
Dr/Pc	Hip Hop	7419	MA_HipHop Loop10	4 / 4	4	95	●		:
Dr/Pc	Hip Hop	7420	MA_HipHop Loop11	4 / 4	4	96	●		:
Dr/Pc	Hip Hop	7421	MA_HipHop Loop12	4 / 4	2	100	●		:
Dr/Pc	Hip Hop	7422	MA_HipHop Loop13	4 / 4	2	100	●		:
Dr/Pc	Hip Hop	7423	MA_HipHop Loop14	4 / 4	1	81	●		:
Dr/Pc	Hip Hop	7424	MA_HipHop Loop15	4 / 4	1	97	●		:
Dr/Pc	Hip Hop	7425	MA_HipHop Loop16	4 / 4	2	100	●		:
Dr/Pc	Hip Hop	7426	MA_HipHop Loop17	4 / 4	2	75	●		:
Dr/Pc	Hip Hop	7427	MA_HipHop Loop18	4 / 4	2	96	●		Illest Hip Hop Kit
Dr/Pc	Hip Hop	7428	MA_HipHop Loop19	4 / 4	2	88	●		:
Dr/Pc	Hip Hop	7429	MA_HipHop Loop20	4 / 4	3	96	●		:
Dr/Pc	Hip Hop	7430	MA_HipHop Loop21	4 / 4	2	93	●		:
Dr/Pc	Hip Hop	7431	MA_HipHop Loop22	4 / 4	2	80	●		:
Dr/Pc	Hip Hop	7432	MA_HipHop Loop23	4 / 4	4	98	●		:
Dr/Pc	Hip Hop	7433	MA_HipHop Loop24	4 / 4	2	92	●		:
Dr/Pc	Hip Hop	7434	MA_HipHop Loop25	4 / 4	2	96	●		:
Dr/Pc	Hip Hop	7435	MA_HipHop Loop26	4 / 4	4	86	●		:
Dr/Pc	Hip Hop	7436	MA_HipHop Loop27	4 / 4	2	95	●		:
Dr/Pc	Hip Hop	7437	MA_HipHop Loop28	4 / 4	4	100	●		:
Dr/Pc	Hip Hop	7438	MA_HipHop Loop29	4 / 4	4	75	●		:
Dr/Pc	Hip Hop	7439	MA_HipHop Loop30	4 / 4	2	96	●		:
Dr/Pc	Hip Hop	7440	MA_HipHop Loop31	4 / 4	2	93	●		:
Dr/Pc	Hip Hop	7441	MA_HipHop Loop32	4 / 4	2	94	●		:
Dr/Pc	Hip Hop	7442	MA_HipHop Loop33	4 / 4	2	100	●		:
Dr/Pc	Hip Hop	7443	MA_HipHop Loop34	4 / 4	2	88	●		:
Dr/Pc	Hip Hop	7444	MA_HipHop Loop35	4 / 4	4	85	●		:
Dr/Pc	Hip Hop	7445	MA_HipHop Loop36	4 / 4	4	90	●		:
Dr/Pc	Hip Hop	7446	MA_HipHop Loop37	4 / 4	4	85	●		:
Dr/Pc	Hip Hop	7447	MA_HipHop Loop38	4 / 4	4	98	●		:
Dr/Pc	Hip Hop	7448	MA_HipHop Loop39	4 / 4	4	95	●		:
Dr/Pc	Hip Hop	7449	MA_HipHop Loop40	4 / 4	2	100	●		:
Dr/Pc	Hip Hop	7450	MA_HipHop Loop41	4 / 4	2	96	●		:
Dr/Pc	Hip Hop	7451	MA_HipHop Loop42	4 / 4	4	100	●		:
Dr/Pc	Hip Hop	7452	MA_HipHop Loop43	4 / 4	4	98	●		:
Dr/Pc	Hip Hop	7453	MA_HipHop Loop44	4 / 4	4	97	●		:
Dr/Pc	Hip Hop	7454	MA_HipHop Loop45	4 / 4	4	97	●		:
Dr/Pc	Hip Hop	7455	MA_HipHop Loop46	4 / 4	4	95	●		:
Dr/Pc	Hip Hop	7456	MA_HipHop Loop47	4 / 4	4	100	●		:
Dr/Pc	Hip Hop	7457	MA_HipHop Loop48	4 / 4	4	85	●		:
Dr/Pc	Hip Hop	7458	MA_HipHop Loop49	4 / 4	2	88	●		:
Dr/Pc	Hip Hop	7459	MA_HipHop Loop50	4 / 4	4	86	●		:
Dr/Pc	Hip Hop	7460	MA_HipHop Loop51	4 / 4	4	97	●		:
Dr/Pc	Hip Hop	7461	MA_HipHop Loop52	4 / 4	4	95	●		:
Dr/Pc	Hip Hop	7462	MA_HipHop Loop53	4 / 4	2	94	●		:
Dr/Pc	Hip Hop	7463	MA_HipHop Loop54	4 / 4	2	80	●		:
Dr/Pc	Hip Hop	7464	MA_HipHop Loop55	4 / 4	4				

Main Category	Sub Category	ARP No.	ARP Name	Time Signature	Length	Original Tempo	Accent	Random SFX	Sound Type
Dr/Pc	Modern R&B	7481	*1 MB_Sucka	4/4	4	96	●		:
Dr/Pc	Modern R&B	7482	*1 MC_Sucka	4/4	4	96	●		:
Dr/Pc	Modern R&B	7483	*1 MD_Sucka	4/4	4	96	●		:
Dr/Pc	Modern R&B	7484	*1 MA_R'n'B Loop 1-1	4/4	4	75	●		T's Hip Hop Kit
Dr/Pc	Modern R&B	7485	*1 MA_R'n'B Loop 1-2	4/4	4	80	●		:
Dr/Pc	Modern R&B	7486	*1 MA_R'n'B Loop 2-1	4/4	4	141	●		DUB Kit
Dr/Pc	Modern R&B	7487	*1 MA_R'n'B Loop 2-2	4/4	4	164	●		Trap Kit
Dr/Pc	Modern R&B	7488	*1 MA_R'n'B Ballad	4/4	4	61	●		T's Hip Hop Kit
Dr/Pc	Modern R&B	7489	*1 MA_Daily	4/4	4	140	●		:
Dr/Pc	Modern R&B	7490	*1 MA_Galaxy	4/4	4	92	●		Trap Kit
Dr/Pc	Modern R&B	7491	*1 MA_Port & Starboard	4/4	4	160	●		:
Dr/Pc	Modern R&B	7492	*1 MB_Port & Starboard	4/4	4	160	●		:
Dr/Pc	Modern R&B	7493	*1 MC_Port & Starboard	4/4	4	160	●		:
Dr/Pc	Modern R&B	7494	MA_Neo UK Soul	4/4	4	79	●		Hyper Standard Kit
Dr/Pc	Modern R&B	7495	MB_Neo UK Soul	4/4	4	79	●		:
Dr/Pc	Modern R&B	7496	MC_Neo UK Soul	4/4	4	79	●		:
Dr/Pc	Modern R&B	7497	MD_Neo UK Soul	4/4	4	79	●		:
Dr/Pc	Modern R&B	7498	FA_Neo UK Soul	4/4	1	79	●		:
Dr/Pc	Modern R&B	7499	FB_Neo UK Soul	4/4	1	79	●		:
Dr/Pc	Modern R&B	7500	FC_Neo UK Soul	4/4	1	79	●		:
Dr/Pc	Modern R&B	7501	FD_Neo UK Soul	4/4	1	79	●		:
Dr/Pc	Modern R&B	7502	EA_Neo UK Soul	4/4	3	79	●		:
Dr/Pc	Modern R&B	7503	MA_Slow & Easy	4/4	4	72	●		Power Standard Kit 1
Dr/Pc	Modern R&B	7504	MB_Slow & Easy	4/4	4	72	●		:
Dr/Pc	Modern R&B	7505	MC_Slow & Easy	4/4	4	72	●		:
Dr/Pc	Modern R&B	7506	FA_Slow & Easy	4/4	1	72	●		:
Dr/Pc	Modern R&B	7507	FB_Slow & Easy	4/4	1	72	●		:
Dr/Pc	Modern R&B	7508	FC_Slow & Easy	4/4	1	72	●		:
Dr/Pc	Modern R&B	7509	BA_Slow & Easy	4/4	1	72	●		:
Dr/Pc	Modern R&B	7510	EA_Slow & Easy	4/4	3	72	●		:
Dr/Pc	Modern R&B	7511	EB_Slow & Easy	4/4	4	72	●		:
Dr/Pc	Modern R&B	7512	MA_Pop Shuffle2	4/4	4	94	●		:
Dr/Pc	Modern R&B	7513	MB_Pop Shuffle2	4/4	4	94	●		:
Dr/Pc	Modern R&B	7514	MC_Pop Shuffle2	4/4	4	94	●		:
Dr/Pc	Modern R&B	7515	FA_Pop Shuffle2	4/4	1	94	●		:
Dr/Pc	Modern R&B	7516	FB_Pop Shuffle2	4/4	1	94	●		:
Dr/Pc	Modern R&B	7517	FC_Pop Shuffle2	4/4	1	94	●		:
Dr/Pc	Modern R&B	7518	BA_Pop Shuffle2	4/4	1	94	●		:
Dr/Pc	Modern R&B	7519	MA_Pop Shuffle3	4/4	4	80	●		R&B Kit 3
Dr/Pc	Modern R&B	7520	MB_Pop Shuffle3	4/4	4	80	●		:
Dr/Pc	Modern R&B	7521	MC_Pop Shuffle3	4/4	4	80	●		:
Dr/Pc	Modern R&B	7522	FA_Pop Shuffle3	4/4	1	80	●		:
Dr/Pc	Modern R&B	7523	FB_Pop Shuffle3	4/4	1	80	●		:
Dr/Pc	Modern R&B	7524	FC_Pop Shuffle3	4/4	1	80	●		:
Dr/Pc	Modern R&B	7525	BA_Pop Shuffle3	4/4	1	80	●		:
Dr/Pc	Modern R&B	7526	MA_R&B Disco	4/4	2	110	●		Dry Standard Kit
Dr/Pc	Modern R&B	7527	MB_R&B Disco	4/4	2	110	●		:
Dr/Pc	Modern R&B	7528	MC_R&B Disco	4/4	2	110	●		:
Dr/Pc	Modern R&B	7529	MD_R&B Disco	4/4	2	110	●		:
Dr/Pc	Modern R&B	7530	IA_R&B Disco	4/4	1	110	●		:
Dr/Pc	Modern R&B	7531	FA_R&B Disco	4/4	1	110	●		:
Dr/Pc	Modern R&B	7532	FB_R&B Disco	4/4	1	110	●		:
Dr/Pc	Modern R&B	7533	FC_R&B Disco	4/4	2	110	●		:
Dr/Pc	Modern R&B	7534	MA_Chart R&B	4/4	4	130	●		R&B Kit 1
Dr/Pc	Modern R&B	7535	MB_Chart R&B	4/4	4	130	●		:
Dr/Pc	Modern R&B	7536	MC_Chart R&B	4/4	4	130	●		:
Dr/Pc	Modern R&B	7537	FA_Chart R&B	4/4	1	130	●		:
Dr/Pc	Modern R&B	7538	FB_Chart R&B	4/4	1	130	●		:
Dr/Pc	Modern R&B	7539	FC_Chart R&B	4/4	1	130	●		:
Dr/Pc	Modern R&B	7540	BA_Chart R&B	4/4	1	130	●		:
Dr/Pc	Modern R&B	7541	EA_Chart R&B	4/4	5	130	●		:
Dr/Pc	Modern R&B	7542	EB_Chart R&B	4/4	10	130	●		:
Dr/Pc	Modern R&B	7543	MA1_ChartPop1	4/4	4	92	●		Hip Hop Kit 3
Dr/Pc	Modern R&B	7544	MB1_ChartPop1	4/4	4	92	●		:
Dr/Pc	Modern R&B	7545	MC1_ChartPop1	4/4	4	92	●		:
Dr/Pc	Modern R&B	7546	FA1_ChartPop1	4/4	1	92	●		:
Dr/Pc	Modern R&B	7547	FB1_ChartPop1	4/4	1	92	●		:
Dr/Pc	Modern R&B	7548	FC1_ChartPop1	4/4	1	92	●		:
Dr/Pc	Modern R&B	7549	BA1_ChartPop1	4/4	1	92	●		:
Dr/Pc	Modern R&B	7550	EA1_ChartPop1	4/4	3	92	●		:
Dr/Pc	Modern R&B	7551	EB1_ChartPop1	4/4	3	92	●		:
Dr/Pc	Modern R&B	7552	MA2_ChartPop1	4/4	4	92	●		Power Standard Kit 2
Dr/Pc	Modern R&B	7553	MB2_ChartPop1	4/4	4	92	●		:
Dr/Pc	Modern R&B	7554	MC2_ChartPop1	4/4	4	92	●		:
Dr/Pc	Modern R&B	7555	FA2_ChartPop1	4/4	1	92	●		:
Dr/Pc	Modern R&B	7556	FB2_ChartPop1	4/4	1	92	●		:
Dr/Pc	Modern R&B	7557	FC2_ChartPop1	4/4	1	92	●		:
Dr/Pc	Modern R&B	7558	BA2_ChartPop1	4/4	1	92	●		:
Dr/Pc	Modern R&B	7559	EA2_ChartPop1	4/4	3	92	●		:
Dr/Pc	Modern R&B	7560	EB2_ChartPop1	4/4	3	92	●		:
Dr/Pc	Modern R&B	7561	MA1_ChartPop2	4/4	2	92	●		Hip Hop Kit 3
Dr/Pc	Modern R&B	7562	MB1_ChartPop2	4/4	2	92	●		:
Dr/Pc	Modern R&B	7563	MC1_ChartPop2	4/4	2	92	●		:
Dr/Pc	Modern R&B	7564	MD1_ChartPop2	4/4	2	92	●		:
Dr/Pc	Modern R&B	7565	FA1_ChartPop2	4/4	1	92	●		:
Dr/Pc	Modern R&B	7566	FC1_ChartPop2	4/4	1	92	●		:
Dr/Pc	Modern R&B	7567	FD1_ChartPop2	4/4	1	92	●		:

Main Category	Sub Category	ARP No.	ARP Name	Time Signature	Length	Original Tempo	Accent	Random SFX	Sound Type
Dr/Pc	Modern R&B	7568	MA2_ChartPop2	4/4	2	92	●		Hip Hop Kit 1
Dr/Pc	Modern R&B	7569	MB2_ChartPop2	4/4	2	92	●		:
Dr/Pc	Modern R&B	7570	MC2_ChartPop2	4/4	2	92	●		:
Dr/Pc	Modern R&B	7571	MD2_ChartPop2	4/4	2	92	●		:
Dr/Pc	Modern R&B	7572	FA2_ChartPop2	4/4	1	92	●		:
Dr/Pc	Modern R&B	7573	FB2_ChartPop2	4/4	1	92	●		:
Dr/Pc	Modern R&B	7574	FC2_ChartPop2	4/4	1	92	●		:
Dr/Pc	Modern R&B	7575	FD2_ChartPop2	4/4	1	92	●		:
Dr/Pc	Modern R&B	7576	MA1_R&B	4/4	2	83	●		Power Standard Kit 1
Dr/Pc	Modern R&B	7577	MB1_R&B	4/4	2	83	●		:
Dr/Pc	Modern R&B	7578	MC1_R&B	4/4	2	83	●		:
Dr/Pc	Modern R&B	7579	FA1_R&B	4/4	1	83	●		:
Dr/Pc	Modern R&B	7580	FB1_R&B	4/4	1	83	●		:
Dr/Pc	Modern R&B	7581	FC1_R&B	4/4	1	83	●		:
Dr/Pc	Modern R&B	7582	BA1_R&B	4/4	1	83	●		:
Dr/Pc	Modern R&B	7583	EA1_R&B	4/4	4	83	●		:
Dr/Pc	Modern R&B	7584	EB1_R&B	4/4	4	83	●		:
Dr/Pc	Modern R&B	7585	MA2_R&B	4/4	2	83	●		R&B Kit 1
Dr/Pc	Modern R&B	7586	MB2_R&B	4/4	2	83	●		:
Dr/Pc	Modern R&B	7587	MC2_R&B	4/4	2	83	●		:
Dr/Pc	Modern R&B	7588	FA2_R&B	4/4	1	83	●		:
Dr/Pc	Modern R&B	7589	FB2_R&B	4/4	1	83	●		:
Dr/Pc	Modern R&B	7590	FC2_R&B	4/4	1	83	●		:
Dr/Pc	Modern R&B	7591	BA2_R&B	4/4	1	83	●		:
Dr/Pc	Modern R&B	7592	EA2_R&B	4/4	4	83	●		:
Dr/Pc	Modern R&B	7593	EB2_R&B	4/4	4	83	●		:
Dr/Pc	Modern R&B	7594	MA1_New R&B 1	4/4	2	98	●		Power Standard Kit 1
Dr/Pc	Modern R&B	7595	MB1_New R&B 1	4/4	2	98	●		:
Dr/Pc	Modern R&B	7596	MC1_New R&B 1	4/4	2	98	●		:
Dr/Pc	Modern R&B	7597	FA1_New R&B 1	4/4	1	98	●		:
Dr/Pc	Modern R&B	7598	FB1_New R&B 1	4/4	1	98	●		:
Dr/Pc	Modern R&B	7599	FC1_New R&B 1	4/4	1	98	●		:
Dr/Pc	Modern R&B	7600	BA1_New R&B 1	4/4	1	98	●		:
Dr/Pc	Modern R&B	7601	EA1_New R&B 1	4/4	3	98	●		:
Dr/Pc	Modern R&B	7602	EB1_New R&B 1	4/4	4	98	●		:
Dr/Pc	Modern R&B	7603	MA2_New R&B 1	4/4	2	98	●		R&B Kit 2
Dr/Pc	Modern R&B	7604	MB2_New R&B 1	4/4	2	98	●		:
Dr/Pc	Modern R&B	7605	MC2_New R&B 1	4/4	2	98	●		:
Dr/Pc	Modern R&B	7606	FA2_New R&B 1	4/4	1	98	●		:
Dr/Pc	Modern R&B	7607	FB2_New R&B 1	4/4	1	98	●		:
Dr/Pc	Modern R&B	7608	FC2_New R&B 1	4/4	1	98	●		:
Dr/Pc	Modern R&B	7609	BA2_New R&B 1	4/4	1	98	●		:
Dr/Pc	Modern R&B	7610	EA2_New R&B 1	4/4	3	98	●		:
Dr/Pc	Modern R&B	7611	EB2_New R&B 1	4/4	4	98	●		:
Dr/Pc	Modern R&B	7612	MA1_New R&B 2	4/4	1	97	●		Hip Hop Kit 3
Dr/Pc	Modern R&B	7613	MB1_New R&B 2	4/4	1	97	●		:
Dr/Pc	Modern R&B	7614	MC1_New R&B 2	4/4	1	97	●		:
Dr/Pc	Modern R&B	7615	MD1_New R&B 2	4/4	1	97	●		:
Dr/Pc	Modern R&B	7616	IA1_New R&B 2	4/4	2	97	●		:
Dr/Pc	Modern R&B	7617	FA1_New R&B 2	4/4	1	97	●		:
Dr/Pc	Modern R&B	7618	FB1_New R&B 2	4/4	1	97	●		:
Dr/Pc	Modern R&B	7619	FC1_New R&B 2	4/4	2	97	●		:
Dr/Pc	Modern R&B	7620	MA2_New R&B 3	4/4	2	90	●		:
Dr/Pc	Modern R&B	7621	MB2_New R&B 3	4/4	2	90	●		:
Dr/Pc	Modern R&B	7622	MC2_New R&B 3	4/4	2	90	●		:
Dr/Pc	Modern R&B	7623	MD2_New R&B 3	4/4	2	90	●		:
Dr/Pc	Modern R&B	7624	IA2_New R&B 3	4/4	2	90	●		:
Dr/Pc	Modern R&B	7625	FA2_New R&B 3	4/4	1	90	●		:
Dr/Pc	Modern R&B	7626	FB2_New R&B 3	4/4	1	90	●		:
Dr/Pc	Modern R&B	7627	FC2_New R&B 3	4/4	2	90	●		:
Dr/Pc	Modern R&B	7628	MA_Pop R&B	4/4	4	67	●		Hip Hop Kit 1
Dr/Pc	Modern R&B	7629	MB_Pop R&B	4/4	4	67	●		:
Dr/Pc	Modern R&B	7630	MC_Pop R&B	4/4	4	67	●		:
Dr/Pc	Modern R&B	7631	FA_Pop R&B	4/4	1	67	●		:
Dr/Pc	Modern R&B	7632	FB_Pop R&B	4					

Arpeggio Type List

Main Category	Sub Category	ARP No.	ARP Name	Time Signature	Length	Original Tempo	Accent	Random SFX	Sound Type
Dr/Pc	Modern R&B	7655	BA_R&B Ana Pop	4/4	1	95	●		:
Dr/Pc	Modern R&B	7656	MA_R&B Ballad 1	4/4	4	70	●		Hip Hop Kit 4
Dr/Pc	Modern R&B	7657	MB_R&B Ballad 1	4/4	4	70	●		:
Dr/Pc	Modern R&B	7658	MC_R&B Ballad 1	4/4	4	70	●		:
Dr/Pc	Modern R&B	7659	FA_R&B Ballad 1	4/4	1	70	●		:
Dr/Pc	Modern R&B	7660	FB_R&B Ballad 1	4/4	1	70	●		:
Dr/Pc	Modern R&B	7661	FC_R&B Ballad 1	4/4	1	70	●		:
Dr/Pc	Modern R&B	7662	BA_R&B Ballad 1	4/4	1	70	●		:
Dr/Pc	Modern R&B	7663	MA1_R&B Ballad 2	4/4	2	60	●		Hip Hop Kit 2
Dr/Pc	Modern R&B	7664	MB1_R&B Ballad 2	4/4	2	60	●		:
Dr/Pc	Modern R&B	7665	MC1_R&B Ballad 2	4/4	2	60	●		:
Dr/Pc	Modern R&B	7666	MD1_R&B Ballad 2	4/4	2	60	●		:
Dr/Pc	Modern R&B	7667	FA1_R&B Ballad 2	4/4	1	60	●		:
Dr/Pc	Modern R&B	7668	FB1_R&B Ballad 2	4/4	1	60	●		:
Dr/Pc	Modern R&B	7669	FC1_R&B Ballad 2	4/4	1	60	●		:
Dr/Pc	Modern R&B	7670	FD1_R&B Ballad 2	4/4	1	60	●		:
Dr/Pc	Modern R&B	7671	MA2_R&B Ballad 2	4/4	2	60	●		Hip Hop Kit 1
Dr/Pc	Modern R&B	7672	MB2_R&B Ballad 2	4/4	2	60	●		:
Dr/Pc	Modern R&B	7673	MC2_R&B Ballad 2	4/4	2	60	●		:
Dr/Pc	Modern R&B	7674	MD2_R&B Ballad 2	4/4	2	60	●		:
Dr/Pc	Modern R&B	7675	FA2_R&B Ballad 2	4/4	1	60	●		:
Dr/Pc	Modern R&B	7676	FB2_R&B Ballad 2	4/4	1	60	●		:
Dr/Pc	Modern R&B	7677	FC2_R&B Ballad 2	4/4	1	60	●		:
Dr/Pc	Modern R&B	7678	FD2_R&B Ballad 2	4/4	1	60	●		:
Dr/Pc	Modern R&B	7679	MA_R&B Ballad 3	4/4	4	113	●		R&B Kit 2
Dr/Pc	Modern R&B	7680	MB_R&B Ballad 3	4/4	4	113	●		:
Dr/Pc	Modern R&B	7681	MC_R&B Ballad 3	4/4	4	113	●		:
Dr/Pc	Modern R&B	7682	FA_R&B Ballad 3	4/4	1	113	●		:
Dr/Pc	Modern R&B	7683	FB_R&B Ballad 3	4/4	1	113	●		:
Dr/Pc	Modern R&B	7684	FC_R&B Ballad 3	4/4	1	113	●		:
Dr/Pc	Modern R&B	7685	BA_R&B Ballad 3	4/4	1	113	●		:
Dr/Pc	Modern R&B	7686	MA_6/8 R&B	4/4	2	61	●		Hip Hop Kit 3
Dr/Pc	Modern R&B	7687	MB_6/8 R&B	4/4	2	61	●		:
Dr/Pc	Modern R&B	7688	MC_6/8 R&B	4/4	2	61	●		:
Dr/Pc	Modern R&B	7689	MD_6/8 R&B	4/4	2	61	●		:
Dr/Pc	Modern R&B	7690	IA_6/8 R&B	4/4	2	61	●		:
Dr/Pc	Modern R&B	7691	FA_6/8 R&B	4/4	1	61	●		:
Dr/Pc	Modern R&B	7692	FB_6/8 R&B	4/4	1	61	●		:
Dr/Pc	Modern R&B	7693	FC_6/8 R&B	4/4	2	61	●		:
Dr/Pc	Modern R&B	7694	MA_Smooth 1	4/4	2	115	●		:
Dr/Pc	Modern R&B	7695	MB_Smooth 1	4/4	2	115	●		:
Dr/Pc	Modern R&B	7696	MC_Smooth 1	4/4	2	115	●		:
Dr/Pc	Modern R&B	7697	MD_Smooth 1	4/4	2	115	●		:
Dr/Pc	Modern R&B	7698	IA_Smooth 1	4/4	2	115	●		:
Dr/Pc	Modern R&B	7699	FA_Smooth 1	4/4	1	115	●		:
Dr/Pc	Modern R&B	7700	FB_Smooth 1	4/4	1	115	●		:
Dr/Pc	Modern R&B	7701	FC_Smooth 1	4/4	2	115	●		:
Dr/Pc	Modern R&B	7702	MA_Smooth 2	4/4	4	64	●		Hip Hop Kit 1
Dr/Pc	Modern R&B	7703	MB_Smooth 2	4/4	4	64	●		:
Dr/Pc	Modern R&B	7704	MC_Smooth 2	4/4	4	64	●		:
Dr/Pc	Modern R&B	7705	MD_Smooth 2	4/4	4	64	●		:
Dr/Pc	Modern R&B	7706	MA_Flip Hop 1	4/4	2	132	●		Hip Hop Kit 3
Dr/Pc	Modern R&B	7707	MB_Flip Hop 1	4/4	2	132	●		:
Dr/Pc	Modern R&B	7708	MC_Flip Hop 1	4/4	2	132	●		:
Dr/Pc	Modern R&B	7709	MD_Flip Hop 1	4/4	2	132	●		:
Dr/Pc	Modern R&B	7710	IA_Flip Hop 1	4/4	2	132	●		:
Dr/Pc	Modern R&B	7711	FA_Flip Hop 1	4/4	1	132	●		:
Dr/Pc	Modern R&B	7712	FB_Flip Hop 1	4/4	1	132	●		:
Dr/Pc	Modern R&B	7713	FC_Flip Hop 1	4/4	4	132	●		:
Dr/Pc	Modern R&B	7714	MA_Flip Hop 2	4/4	4	125	●		:
Dr/Pc	Modern R&B	7715	MB_Flip Hop 2	4/4	4	125	●		:
Dr/Pc	Modern R&B	7716	MC_Flip Hop 2	4/4	4	125	●		:
Dr/Pc	Modern R&B	7717	MD_Flip Hop 2	4/4	4	125	●		:
Dr/Pc	Modern R&B	7718	MA_New Gospel	4/4	2	90	●		:
Dr/Pc	Modern R&B	7719	MB_New Gospel	4/4	2	90	●		:
Dr/Pc	Modern R&B	7720	MC_New Gospel	4/4	2	90	●		:
Dr/Pc	Modern R&B	7721	MD_New Gospel	4/4	2	90	●		:
Dr/Pc	Modern R&B	7722	IA_New Gospel	4/4	1	90	●		:
Dr/Pc	Modern R&B	7723	FA_New Gospel	4/4	1	90	●		:
Dr/Pc	Modern R&B	7724	FB_New Gospel	4/4	1	90	●		:
Dr/Pc	Modern R&B	7725	FC_New Gospel	4/4	2	90	●		:
Dr/Pc	Classic R&B	7726	MA1_StandrdDisco	4/4	4	120	●		Power Standard Kit 2
Dr/Pc	Classic R&B	7727	MB1_StandrdDisco	4/4	4	120	●		:
Dr/Pc	Classic R&B	7728	MC1_StandrdDisco	4/4	4	120	●		:
Dr/Pc	Classic R&B	7729	FA1_StandrdDisco	4/4	1	120	●		:
Dr/Pc	Classic R&B	7730	FB1_StandrdDisco	4/4	1	120	●		:
Dr/Pc	Classic R&B	7731	FC1_StandrdDisco	4/4	1	120	●		:
Dr/Pc	Classic R&B	7732	BA1_StandrdDisco	4/4	1	120	●		:
Dr/Pc	Classic R&B	7733	EA1_StandrdDisco	4/4	3	120	●		:
Dr/Pc	Classic R&B	7734	EB1_StandrdDisco	4/4	3	120	●		:
Dr/Pc	Classic R&B	7735	MA2_StandrdDisco	4/4	4	120	●		Pop Latin Kit
Dr/Pc	Classic R&B	7736	MB2_StandrdDisco	4/4	4	120	●		:
Dr/Pc	Classic R&B	7737	MC2_StandrdDisco	4/4	4	120	●		:
Dr/Pc	Classic R&B	7738	FA2_StandrdDisco	4/4	1	120	●		:
Dr/Pc	Classic R&B	7739	FB2_StandrdDisco	4/4	1	120	●		:
Dr/Pc	Classic R&B	7740	FC2_StandrdDisco	4/4	1	120	●		:
Dr/Pc	Classic R&B	7741	BA2_StandrdDisco	4/4	1	120	●		:

Main Category	Sub Category	ARP No.	ARP Name	Time Signature	Length	Original Tempo	Accent	Random SFX	Sound Type
Dr/Pc	Classic R&B	7742	EA2_StandrdDisco	4/4	3	120	●		:
Dr/Pc	Classic R&B	7743	EB2_StandrdDisco	4/4	3	120	●		:
Dr/Pc	Classic R&B	7744	MA1_Retro Disco	4/4	4	108	●		Power Standard Kit 1
Dr/Pc	Classic R&B	7745	MB1_Retro Disco	4/4	4	108	●		:
Dr/Pc	Classic R&B	7746	MC1_Retro Disco	4/4	4	108	●		:
Dr/Pc	Classic R&B	7747	FA1_Retro Disco	4/4	1	108	●		:
Dr/Pc	Classic R&B	7748	FB1_Retro Disco	4/4	1	108	●		:
Dr/Pc	Classic R&B	7749	FC1_Retro Disco	4/4	1	108	●		:
Dr/Pc	Classic R&B	7750	BA1_Retro Disco	4/4	1	108	●		:
Dr/Pc	Classic R&B	7751	EA1_Retro Disco	4/4	4	108	●		:
Dr/Pc	Classic R&B	7752	EB1_Retro Disco	4/4	4	108	●		:
Dr/Pc	Classic R&B	7753	MA2_Retro Disco	4/4	4	108	●		Pop Latin Kit
Dr/Pc	Classic R&B	7754	MB2_Retro Disco	4/4	4	108	●		:
Dr/Pc	Classic R&B	7755	MC2_Retro Disco	4/4	4	108	●		:
Dr/Pc	Classic R&B	7756	FA2_Retro Disco	4/4	1	108	●		:
Dr/Pc	Classic R&B	7757	FB2_Retro Disco	4/4	1	108	●		:
Dr/Pc	Classic R&B	7758	FC2_Retro Disco	4/4	1	108	●		:
Dr/Pc	Classic R&B	7759	BA2_Retro Disco	4/4	1	108	●		:
Dr/Pc	Classic R&B	7760	EA2_Retro Disco	4/4	4	108	●		:
Dr/Pc	Classic R&B	7761	EB2_Retro Disco	4/4	4	108	●		:
Dr/Pc	Classic R&B	7762	MA1_70sCoolDisco	4/4	4	114	●		Power Standard Kit 1
Dr/Pc	Classic R&B	7763	MB1_70sCoolDisco	4/4	4	114	●		:
Dr/Pc	Classic R&B	7764	MC1_70sCoolDisco	4/4	4	114	●		:
Dr/Pc	Classic R&B	7765	FA1_70sCoolDisco	4/4	1	114	●		:
Dr/Pc	Classic R&B	7766	FB1_70sCoolDisco	4/4	1	114	●		:
Dr/Pc	Classic R&B	7767	FC1_70sCoolDisco	4/4	1	114	●		:
Dr/Pc	Classic R&B	7768	BA1_70sCoolDisco	4/4	1	114	●		:
Dr/Pc	Classic R&B	7769	EA1_70sCoolDisco	4/4	4	114	●		:
Dr/Pc	Classic R&B	7770	EB1_70sCoolDisco	4/4	3	114	●		:
Dr/Pc	Classic R&B	7771	MA2_70sCoolDisco	4/4	4	114	●		Pop Latin Kit
Dr/Pc	Classic R&B	7772	MB2_70sCoolDisco	4/4	4	114	●		:
Dr/Pc	Classic R&B	7773	MC2_70sCoolDisco	4/4	4	114	●		:
Dr/Pc	Classic R&B	7774	FA2_70sCoolDisco	4/4	1	114	●		:
Dr/Pc	Classic R&B	7775	FB2_70sCoolDisco	4/4	1	114	●		:
Dr/Pc	Classic R&B	7776	FC2_70sCoolDisco	4/4	1	114	●		:
Dr/Pc	Classic R&B	7777	BA2_70sCoolDisco	4/4	1	114	●		:
Dr/Pc	Classic R&B	7778	EA2_70sCoolDisco	4/4	4	114	●		:
Dr/Pc	Classic R&B	7779	EB2_70sCoolDisco	4/4	3	114	●		:
Dr/Pc	Classic R&B	7780	MA_Philly	4/4	2	100	●		Power Standard Kit 1
Dr/Pc	Classic R&B	7781	MB_Philly	4/4	2	100	●		:
Dr/Pc	Classic R&B	7782	MC_Philly	4/4	2	100	●		:
Dr/Pc	Classic R&B	7783	FA_Philly	4/4	1	100	●		:
Dr/Pc	Classic R&B	7784	FB_Philly	4/4	1	100	●		:
Dr/Pc	Classic R&B	7785	FC_Philly	4/4	1	100	●		:
Dr/Pc	Classic R&B	7786	BA_Philly	4/4	1	100	●		:
Dr/Pc	Classic R&B	7787	EA_Philly	4/4	4	100	●		:
Dr/Pc	Classic R&B	7788	EB_Philly	4/4	3	100	●		:
Dr/Pc	Classic R&B	7789	MA_Soul 1	4/4	2	116	●		:
Dr/Pc	Classic R&B	7790	MB_Soul 1	4/4	2	116	●		:
Dr/Pc	Classic R&B	7791	MC_Soul 1	4/4	2	116	●		:
Dr/Pc	Classic R&B	7792	FA_Soul 1	4/4	1	116	●		:
Dr/Pc	Classic R&B	7793	FB_Soul 1	4/4	1	116	●		:
Dr/Pc	Classic R&B	7794	FC_Soul 1	4/4	1	116	●		:
Dr/Pc	Classic R&B	7795	BA_Soul 1	4/4	1	116	●		:
Dr/Pc	Classic R&B	7796	EA_Soul 1	4/4	4	116	●		:
Dr/Pc	Classic R&B	7797	EB_Soul 1	4/4	3	116	●		:
Dr/Pc	Classic R&B	7798	MA_Soul 2	4/4	4	120	●		Dry Standard Kit
Dr/Pc	Classic R&B	7799	MB_Soul 2	4/4	4	120	●		:
Dr/Pc	Classic R&B	7800	MC_Soul 2	4/4	4	120	●		:
Dr/Pc	Classic R&B	7801	MD_Soul 2	4/4	4	120	●		:
Dr/Pc	Classic R&B	7802	IA_Soul 2	4/4	1	120	●		:
Dr/Pc	Classic R&B	7803	FA_Soul 2	4/4	1	120	●		:
Dr/Pc	Classic R&B	7804	FB_Soul 2	4/4	1	120	●		:
Dr/Pc	Classic R&B	7805	FC_Soul 2	4/4	4	120	●		:

Main Category	Sub Category	ARP No.	ARP Name	Time Signature	Length	Original Tempo	Accent	Random SFX	Sound Type
Dr/Pc	Classic R&B	7829	EA_70sChartSoul	4/4	5	108	●		:
Dr/Pc	Classic R&B	7830	EB_70sChartSoul	4/4	3	108	●		:
Dr/Pc	Classic R&B	7831	MA_Frankly Soul	4/4	4	120	●		Power Standard Kit 1
Dr/Pc	Classic R&B	7832	MB_Frankly Soul	4/4	4	120	●		:
Dr/Pc	Classic R&B	7833	MC_Frankly Soul	4/4	4	120	●		:
Dr/Pc	Classic R&B	7834	FA_Frankly Soul	4/4	1	120	●		:
Dr/Pc	Classic R&B	7835	FB_Frankly Soul	4/4	1	120	●		:
Dr/Pc	Classic R&B	7836	FC_Frankly Soul	4/4	1	120	●		:
Dr/Pc	Classic R&B	7837	BA_Frankly Soul	4/4	1	120	●		:
Dr/Pc	Classic R&B	7838	EA_Frankly Soul	4/4	3	120	●		:
Dr/Pc	Classic R&B	7839	EB_Frankly Soul	4/4	4	120	●		:
Dr/Pc	Classic R&B	7840	MA_Soul Beat	4/4	4	124	●		:
Dr/Pc	Classic R&B	7841	MB_Soul Beat	4/4	4	124	●		:
Dr/Pc	Classic R&B	7842	MC_Soul Beat	4/4	4	124	●		:
Dr/Pc	Classic R&B	7843	FA_Soul Beat	4/4	1	124	●		:
Dr/Pc	Classic R&B	7844	FB_Soul Beat	4/4	1	124	●		:
Dr/Pc	Classic R&B	7845	FC_Soul Beat	4/4	1	124	●		:
Dr/Pc	Classic R&B	7846	BA_Soul Beat	4/4	1	124	●		:
Dr/Pc	Classic R&B	7847	EA_Soul Beat	4/4	3	123	●		:
Dr/Pc	Classic R&B	7848	EB_Soul Beat	4/4	3	123	●		:
Dr/Pc	Classic R&B	7849	MA_Soul Band	4/4	4	129	●		Power Standard Kit 2
Dr/Pc	Classic R&B	7850	MB_Soul Band	4/4	4	129	●		:
Dr/Pc	Classic R&B	7851	MC_Soul Band	4/4	4	129	●		:
Dr/Pc	Classic R&B	7852	FA_Soul Band	4/4	1	129	●		:
Dr/Pc	Classic R&B	7853	FB_Soul Band	4/4	1	129	●		:
Dr/Pc	Classic R&B	7854	FC_Soul Band	4/4	1	129	●		:
Dr/Pc	Classic R&B	7855	BA_Soul Band	4/4	1	129	●		:
Dr/Pc	Classic R&B	7856	MA_Soul Shuffle	4/4	4	98	●		:
Dr/Pc	Classic R&B	7857	MB_Soul Shuffle	4/4	4	98	●		:
Dr/Pc	Classic R&B	7858	MC_Soul Shuffle	4/4	4	98	●		:
Dr/Pc	Classic R&B	7859	FA_Soul Shuffle	4/4	1	98	●		:
Dr/Pc	Classic R&B	7860	FB_Soul Shuffle	4/4	1	98	●		:
Dr/Pc	Classic R&B	7861	FC_Soul Shuffle	4/4	1	98	●		:
Dr/Pc	Classic R&B	7862	BA_Soul Shuffle	4/4	1	98	●		:
Dr/Pc	Classic R&B	7863	EA_Soul Shuffle	4/4	3	98	●		:
Dr/Pc	Classic R&B	7864	EB_Soul Shuffle	4/4	3	98	●		:
Dr/Pc	Classic R&B	7865	MA_Soul Swing	4/4	4	124	●		Power Standard Kit 1
Dr/Pc	Classic R&B	7866	MB_Soul Swing	4/4	4	124	●		:
Dr/Pc	Classic R&B	7867	MC_Soul Swing	4/4	4	124	●		:
Dr/Pc	Classic R&B	7868	FA_Soul Swing	4/4	1	124	●		:
Dr/Pc	Classic R&B	7869	FB_Soul Swing	4/4	1	124	●		:
Dr/Pc	Classic R&B	7870	FC_Soul Swing	4/4	1	124	●		:
Dr/Pc	Classic R&B	7871	BA_Soul Swing	4/4	1	124	●		:
Dr/Pc	Classic R&B	7872	EA_Soul Swing	4/4	3	123	●		:
Dr/Pc	Classic R&B	7873	EB_Soul Swing	4/4	5	123	●		:
Dr/Pc	Classic R&B	7874	MA_GospelBrothr	4/4	4	108	●		:
Dr/Pc	Classic R&B	7875	MB_GospelBrothr	4/4	4	108	●		:
Dr/Pc	Classic R&B	7876	MC_GospelBrothr	4/4	4	108	●		:
Dr/Pc	Classic R&B	7877	FA_GospelBrothr	4/4	1	108	●		:
Dr/Pc	Classic R&B	7878	FB_GospelBrothr	4/4	1	108	●		:
Dr/Pc	Classic R&B	7879	FC_GospelBrothr	4/4	1	108	●		:
Dr/Pc	Classic R&B	7880	BA_GospelBrothr	4/4	1	108	●		:
Dr/Pc	Classic R&B	7881	EA_GospelBrothr	4/4	4	108	●		:
Dr/Pc	Classic R&B	7882	EB_GospelBrothr	4/4	3	108	●		:
Dr/Pc	Classic R&B	7883	MA_Gospel	3/4	4	126	●		Dry Standard Kit
Dr/Pc	Classic R&B	7884	MB_Gospel	3/4	2	126	●		:
Dr/Pc	Funk	7885	MA_Moving Through	4/4	4	105	●		Break Kit
Dr/Pc	Funk	7886	MA_Urban Funk	4/4	4	115	●		Power Standard Kit 1
Dr/Pc	Funk	7887	MB_Urban Funk	4/4	4	115	●		:
Dr/Pc	Funk	7888	MC_Urban Funk	4/4	4	115	●		:
Dr/Pc	Funk	7889	MD_Urban Funk	4/4	4	115	●		:
Dr/Pc	Funk	7890	FA_Urban Funk	4/4	1	115	●		:
Dr/Pc	Funk	7891	FB_Urban Funk	4/4	1	115	●		:
Dr/Pc	Funk	7892	FC_Urban Funk	4/4	1	115	●		:
Dr/Pc	Funk	7893	FD_Urban Funk	4/4	1	115	●		:
Dr/Pc	Funk	7894	EA_Urban Funk	4/4	5	115	●		:
Dr/Pc	Funk	7895	MA_Funk 1	4/4	8	104	●		:
Dr/Pc	Funk	7896	MB_Funk 1	4/4	8	104	●		:
Dr/Pc	Funk	7897	MC_Funk 1	4/4	8	104	●		:
Dr/Pc	Funk	7898	FA_Funk 1	4/4	1	104	●		:
Dr/Pc	Funk	7899	FB_Funk 1	4/4	1	104	●		:
Dr/Pc	Funk	7900	FC_Funk 1	4/4	1	104	●		:
Dr/Pc	Funk	7901	BA_Funk 1	4/4	1	104	●		:
Dr/Pc	Funk	7902	EA_Funk 1	4/4	9	104	●		:
Dr/Pc	Funk	7903	EB_Funk 1	4/4	4	104	●		:
Dr/Pc	Funk	7904	MA_Funk 2 /1	4/4	4	107	●		Hyper Standard Kit
Dr/Pc	Funk	7905	MB_Funk 2 /1	4/4	4	107	●		:
Dr/Pc	Funk	7906	MC_Funk 2	4/4	4	107	●		:
Dr/Pc	Funk	7907	MD_Funk 2	4/4	4	107	●		:
Dr/Pc	Funk	7908	IA_Funk 2	4/4	4	107	●		:
Dr/Pc	Funk	7909	FA_Funk 2	4/4	1	107	●		:
Dr/Pc	Funk	7910	FB_Funk 2 /1	4/4	1	107	●		:
Dr/Pc	Funk	7911	FC_Funk 2 /1	4/4	1	107	●		:
Dr/Pc	Funk	7912	MA_Funk 2 /2	4/4	2	107	●		:
Dr/Pc	Funk	7913	MB_Funk 2 /2	4/4	4	107	●		:
Dr/Pc	Funk	7914	FB_Funk 2 /2	4/4	1	107	●		:
Dr/Pc	Funk	7915	FC_Funk 2 /2	4/4	1	107	●		:

Main Category	Sub Category	ARP No.	ARP Name	Time Signature	Length	Original Tempo	Accent	Random SFX	Sound Type
Dr/Pc	Funk	7916	MA_Funk 3	4/4	2	132	●		Dry Standard Kit
Dr/Pc	Funk	7917	MB_Funk 3	4/4	2	132	●		:
Dr/Pc	Funk	7918	MC_Funk 3	4/4	4	132	●		:
Dr/Pc	Funk	7919	MD_Funk 3	4/4	4	132	●		:
Dr/Pc	Funk	7920	IA_Funk 3	4/4	1	132	●		:
Dr/Pc	Funk	7921	FA_Funk 3	4/4	1	132	●		:
Dr/Pc	Funk	7922	FB_Funk 3	4/4	1	132	●		:
Dr/Pc	Funk	7923	FC_Funk 3	4/4	2	132	●		:
Dr/Pc	Funk	7924	MA_Funk 4	4/4	2	110	●		:
Dr/Pc	Funk	7925	MB_Funk 4	4/4	2	110	●		:
Dr/Pc	Funk	7926	MC_Funk 4	4/4	4	110	●		:
Dr/Pc	Funk	7927	MD_Funk 4	4/4	4	110	●		:
Dr/Pc	Funk	7928	MA_Cool Funk	4/4	2	96	●		Hyper Standard Kit
Dr/Pc	Funk	7929	MB_Cool Funk	4/4	2	96	●		:
Dr/Pc	Funk	7930	MC_Cool Funk	4/4	2	96	●		:
Dr/Pc	Funk	7931	MD_Cool Funk	4/4	2	96	●		:
Dr/Pc	Funk	7932	IA_Cool Funk	4/4	2	96	●		:
Dr/Pc	Funk	7933	FA_Cool Funk	4/4	1	96	●		:
Dr/Pc	Funk	7934	FB_Cool Funk	4/4	1	96	●		:
Dr/Pc	Funk	7935	FC_Cool Funk	4/4	2	96	●		:
Dr/Pc	Funk	7936	MA_Funk PopRock	4/4	4	95	●		Power Standard Kit 1
Dr/Pc	Funk	7937	MB_Funk PopRock	4/4	4	95	●		:
Dr/Pc	Funk	7938	MC_Funk PopRock	4/4	4	95	●		:
Dr/Pc	Funk	7939	FA_Funk PopRock	4/4	1	95	●		:
Dr/Pc	Funk	7940	FB_Funk PopRock	4/4	1	95	●		:
Dr/Pc	Funk	7941	FC_Funk PopRock	4/4	1	95	●		:
Dr/Pc	Funk	7942	BA_Funk PopRock	4/4	1	95	●		:
Dr/Pc	Funk	7943	EA_Funk PopRock	4/4	4	94	●		:
Dr/Pc	Funk	7944	EB_Funk PopRock	4/4	3	94	●		:
Dr/Pc	Funk	7945	MA_Jazz Funk 1	4/4	4	120	●		:
Dr/Pc	Funk	7946	MB_Jazz Funk 1	4/4	4	120	●		:
Dr/Pc	Funk	7947	MC_Jazz Funk 1	4/4	4	120	●		:
Dr/Pc	Funk	7948	FA_Jazz Funk 1	4/4	1	120	●		:
Dr/Pc	Funk	7949	FB_Jazz Funk 1	4/4	1	120	●		:
Dr/Pc	Funk	7950	FC_Jazz Funk 1	4/4	1	120	●		:
Dr/Pc	Funk	7951	BA_Jazz Funk 1	4/4	1	120	●		:
Dr/Pc	Funk	7952	EA_Jazz Funk 1	4/4	3	120	●		:
Dr/Pc	Funk	7953	EB_Jazz Funk 1	4/4	3	120	●		:
Dr/Pc	Funk	7954	MA_Jazz Funk 2	4/4	4	120	●		Dry Standard Kit
Dr/Pc	Funk	7955	MB_Jazz Funk 2	4/4	4	120	●		:
Dr/Pc	Funk	7956	MC_Jazz Funk 2	4/4	4	120	●		:
Dr/Pc	Funk	7957	MD_Jazz Funk 2	4/4	4	120	●		:
Dr/Pc	Funk	7958	IA_Jazz Funk 2	4/4	2	120	●		:
Dr/Pc	Funk	7959	FA_Jazz Funk 2	4/4	1	120	●		:
Dr/Pc	Funk	7960	FB_Jazz Funk 2	4/4	1	120	●		:
Dr/Pc	Funk	7961	FC_Jazz Funk 2	4/4	1	120	●		:
Dr/Pc	Funk	7962	MA1_Jazz Funk 3	4/4	4	123	●		Hip Hop Kit 1
Dr/Pc	Funk	7963	MB1_Jazz Funk 3	4/4	4	123	●		:
Dr/Pc	Funk	7964	MC1_Jazz Funk 3	4/4	4	123	●		:
Dr/Pc	Funk	7965	MD1_Jazz Funk 3	4/4	2	123	●		:
Dr/Pc	Funk	7966	FA1_Jazz Funk 3	4/4	1	123	●		:
Dr/Pc	Funk	7967	FB1_Jazz Funk 3	4/4	1	123	●		:
Dr/Pc	Funk	7968	FC1_Jazz Funk 3	4/4	1	123	●		:
Dr/Pc	Funk	7969	FD1_Jazz Funk 3	4/4	1	123	●		:
Dr/Pc	Funk	7970	MA2_Jazz Funk 3	4/4	4	123	●		Latin Percussion Kit
Dr/Pc	Funk	7971	MB2_Jazz Funk 3	4/4	4	123	●		:
Dr/Pc	Funk	7972	MC2_Jazz Funk 3	4/4	4	123	●		:
Dr/Pc	Funk	7973	MD2_Jazz Funk 3	4/4	2	123	●		:
Dr/Pc	Funk	7974	FA2_Jazz Funk 3	4/4	1	123	●		:
Dr/Pc	Funk	7975	FB2_Jazz Funk 3	4/4	1	123	●		:
Dr/Pc	Funk	7976	FC2_Jazz Funk 3	4/4	1	123	●		:
Dr/Pc	Funk	7977	FD2_Jazz Funk 3	4/4	1	123	●		:
Dr/Pc	Funk	7978	MA_Jazz Pop	4/4	2	102	●		Power Standard Kit 1
Dr/Pc	Funk	7979	MB_Jazz Pop	4/4	2	102	●		:
Dr/Pc	Funk	7980	MC_Jazz Pop	4/4	2	102	●		:
Dr/Pc	Funk	7981	FA_Jazz Pop	4/4	1	102	●		:
Dr/Pc	Funk	7982	FB_Jazz Pop	4/4	1	102	●		:
Dr/Pc	Funk	7983	FC_Jazz Pop	4/4	1	102	●		:
Dr/Pc	Funk	7984	BA_Jazz Pop	4/4	1	102	●		:
Dr/Pc	Funk	7985	MA_Club Jazz 1	4/4	4	125	●		:
Dr/Pc	Funk	7986	MB_Club Jazz 1	4/4	4	125	●		:
Dr/Pc	Funk	7987	MC_Club Jazz 1	4/4	4	125	●		:
Dr/Pc	Funk	7							

Arpeggio Type List

Main Category	Sub Category	ARP No.	ARP Name	Time Signature	Length	Original Tempo	Accent	Random SFX	Sound Type
Dr/Pc	Funk	8003	FB_Gospel Funk	4/4	1	106	●		:
Dr/Pc	Funk	8004	FC_Gospel Funk	4/4	1	106	●		:
Dr/Pc	Funk	8005	BA_Gospel Funk	4/4	1	106	●		:
Dr/Pc	Funk	8006	EA_Gospel Funk	4/4	4	106	●		:
Dr/Pc	Funk	8007	EB_Gospel Funk	4/4	3	106	●		:
Dr/Pc	Funk	8008	MA_Funk Disco	4/4	2	126	●		Power Standard Kit 2
Dr/Pc	Funk	8009	MB_Funk Disco	4/4	2	126	●		:
Dr/Pc	Funk	8010	MC_Funk Disco	4/4	2	126	●		:
Dr/Pc	Funk	8011	FA_Funk Disco	4/4	1	126	●		:
Dr/Pc	Funk	8012	FB_Funk Disco	4/4	1	126	●		:
Dr/Pc	Funk	8013	FC_Funk Disco	4/4	1	126	●		:
Dr/Pc	Funk	8014	BA_Funk Disco	4/4	1	126	●		:
Dr/Pc	Funk	8015	EA_Funk Disco	4/4	4	126	●		:
Dr/Pc	Funk	8016	EB_Funk Disco	4/4	3	126	●		:
Dr/Pc	Funk	8017	MA_70sDiscoFunk	4/4	4	112	●		Power Standard Kit 1
Dr/Pc	Funk	8018	MB_70sDiscoFunk	4/4	4	112	●		:
Dr/Pc	Funk	8019	MC_70sDiscoFunk	4/4	4	112	●		:
Dr/Pc	Funk	8020	FA_70sDiscoFunk	4/4	1	112	●		:
Dr/Pc	Funk	8021	FB_70sDiscoFunk	4/4	1	112	●		:
Dr/Pc	Funk	8022	FC_70sDiscoFunk	4/4	1	112	●		:
Dr/Pc	Funk	8023	BA_70sDiscoFunk	4/4	1	112	●		:
Dr/Pc	Funk	8024	EA_70sDiscoFunk	4/4	4	112	●		:
Dr/Pc	Funk	8025	EB_70sDiscoFunk	4/4	3	112	●		:
Dr/Pc	Funk	8026	MA_Oak Custom	4/4	2	114	●		OakCustom Kit
Dr/Pc	Funk	8027	MB_Oak Custom	4/4	2	114	●		:
Dr/Pc	Funk	8028	MC_Oak Custom	4/4	2	114	●		:
Dr/Pc	Funk	8029	FA_Oak Custom	4/4	1	114	●		:
Dr/Pc	Funk	8030	FC_Oak Custom	4/4	1	114	●		:
Dr/Pc	Funk	8031	EA_Oak Custom	4/4	4	114	●		:
Dr/Pc	Funk	8032	*1 MA_Chevy Break	4/4	4	101	●		Downtempo HipHop Kit
Dr/Pc	Funk	8033	*1 MA_Funk I Like	4/4	4	132	●		:
Dr/Pc	Funk	8034	*1 MA_24K Gold	4/4	4	106	●		:
Dr/Pc	Funk	8035	*1 MA_My Style	4/4	4	112	●		T's Hip Hop Kit
Dr/Pc	Techno	8036	MA1_8Z Undergrnd	4/4	4	100	●		8Z Noise Xpress
Dr/Pc	Techno	8037	MB1_8Z Undergrnd	4/4	4	100	●		:
Dr/Pc	Techno	8038	MC1_8Z Undergrnd	4/4	4	100	●		:
Dr/Pc	Techno	8039	FA1_8Z Undergrnd	4/4	1	100	●		:
Dr/Pc	Techno	8040	FB1_8Z Undergrnd	4/4	1	100	●		:
Dr/Pc	Techno	8041	FC1_8Z Undergrnd	4/4	1	100	●		:
Dr/Pc	Techno	8042	BA1_8Z Undergrnd	4/4	1	100	●		:
Dr/Pc	Techno	8043	MA2_8Z Undergrnd	4/4	4	100	●		8Z Oxidized
Dr/Pc	Techno	8044	MB2_8Z Undergrnd	4/4	4	100	●		:
Dr/Pc	Techno	8045	MC2_8Z Undergrnd	4/4	4	100	●		:
Dr/Pc	Techno	8046	FA2_8Z Undergrnd	4/4	1	100	●		:
Dr/Pc	Techno	8047	FB2_8Z Undergrnd	4/4	1	100	●		:
Dr/Pc	Techno	8048	FC2_8Z Undergrnd	4/4	1	100	●		:
Dr/Pc	Techno	8049	BA2_8Z Undergrnd	4/4	1	100	●		:
Dr/Pc	Techno	8050	MA3_Underground	4/4	4	100	●		Acid Kit
Dr/Pc	Techno	8051	MB3_Underground	4/4	4	100	●		:
Dr/Pc	Techno	8052	MC3_Underground	4/4	4	100	●		:
Dr/Pc	Techno	8053	FA3_Underground	4/4	1	100	●		:
Dr/Pc	Techno	8054	FB3_Underground	4/4	1	100	●		:
Dr/Pc	Techno	8055	FC3_Underground	4/4	1	100	●		:
Dr/Pc	Techno	8056	BA3_Underground	4/4	1	100	●		:
Dr/Pc	Techno	8057	MA4_Underground	4/4	4	100	●		Hard Kit
Dr/Pc	Techno	8058	MB4_Underground	4/4	4	100	●		:
Dr/Pc	Techno	8059	MC4_Underground	4/4	4	100	●		:
Dr/Pc	Techno	8060	FA4_Underground	4/4	1	100	●		:
Dr/Pc	Techno	8061	FB4_Underground	4/4	1	100	●		:
Dr/Pc	Techno	8062	FC4_Underground	4/4	1	100	●		:
Dr/Pc	Techno	8063	BA4_Underground	4/4	1	100	●		:
Dr/Pc	Techno	8064	MA_8Z Destruct	4/4	4	115	●		8Z Destruct
Dr/Pc	Techno	8065	MB_8Z Destruct	4/4	4	115	●		:
Dr/Pc	Techno	8066	MC_8Z Destruct	4/4	4	115	●		:
Dr/Pc	Techno	8067	MD_8Z Destruct	4/4	4	115	●		:
Dr/Pc	Techno	8068	ME_8Z Destruct	4/4	2	115	●		:
Dr/Pc	Techno	8069	MA_8Z Jarrin	4/4	2	105	●		8Z Jarrin
Dr/Pc	Techno	8070	MB_8Z Jarrin	4/4	4	105	●		:
Dr/Pc	Techno	8071	MC_8Z Jarrin	4/4	4	105	●		:
Dr/Pc	Techno	8072	MD_8Z Jarrin	4/4	4	105	●		:
Dr/Pc	Techno	8073	ME_8Z Jarrin	4/4	1	105	●		:
Dr/Pc	Techno	8074	MA_8Z Roms	4/4	4	125	●		8Z Roms
Dr/Pc	Techno	8075	MB_8Z Roms	4/4	4	125	●		:
Dr/Pc	Techno	8076	MC_8Z Roms	4/4	4	125	●		:
Dr/Pc	Techno	8077	MD_8Z Roms	4/4	4	125	●		:
Dr/Pc	Techno	8078	ME_8Z Roms	4/4	2	125	●		:
Dr/Pc	Techno	8079	MA_Dub Element	4/4	2	120	●		8Z Dub Element
Dr/Pc	Techno	8080	MB_Dub Element	4/4	2	120	●		:
Dr/Pc	Techno	8081	MC_Dub Element	4/4	2	120	●		:
Dr/Pc	Techno	8082	FA_Dub Element	4/4	1	120	●		:
Dr/Pc	Techno	8083	FB_Dub Element	4/4	2	120	●		:
Dr/Pc	Techno	8084	FC_Dub Element	4/4	1	120	●		:
Dr/Pc	Techno	8085	BA_Dub Element	4/4	1	120	●		:
Dr/Pc	Techno	8086	MA_Electonica1	4/4	1	118	●		Tekno Kit
Dr/Pc	Techno	8087	MA_Electonica2	4/4	1	118	●		Analog T9 Kit
Dr/Pc	Techno	8088	MA_8Z Heartbrek	4/4	4	90	●		8Z Heavy Hearts
Dr/Pc	Techno	8089	MA_Techno 1	4/4	4	135	●		House Kit 2

Main Category	Sub Category	ARP No.	ARP Name	Time Signature	Length	Original Tempo	Accent	Random SFX	Sound Type
Dr/Pc	Techno	8090	MB_Techno 1	4/4	8	135	●		:
Dr/Pc	Techno	8091	MC_Techno 1	4/4	8	135	●		:
Dr/Pc	Techno	8092	FA_Techno 1	4/4	1	135	●		:
Dr/Pc	Techno	8093	FB_Techno 1	4/4	1	135	●		:
Dr/Pc	Techno	8094	FC_Techno 1	4/4	1	135	●		:
Dr/Pc	Techno	8095	BA_Techno 1	4/4	4	135	●		:
Dr/Pc	Techno	8096	MA_Techno 2	4/4	4	137	●		Trance Kit
Dr/Pc	Techno	8097	MB_Techno 2	4/4	4	137	●		:
Dr/Pc	Techno	8098	FA_Techno 2	4/4	1	137	●		:
Dr/Pc	Techno	8099	FB_Techno 2	4/4	2	137	●		:
Dr/Pc	Techno	8100	FC_Techno 2	4/4	2	137	●		:
Dr/Pc	Techno	8101	MA1_8Z Trance 1	4/4	8	142	●		8Z Psychedelic 1
Dr/Pc	Techno	8102	MB1_8Z Trance 1	4/4	4	142	●		:
Dr/Pc	Techno	8103	MC1_8Z Trance 1	4/4	16	142	●		:
Dr/Pc	Techno	8104	FA1_8Z Trance 1	4/4	2	142	●		:
Dr/Pc	Techno	8105	FB1_8Z Trance 1	4/4	8	142	●		:
Dr/Pc	Techno	8106	FC1_8Z Trance 1	4/4	8	142	●		:
Dr/Pc	Techno	8107	BA1_8Z Trance 1	4/4	1	142	●		:
Dr/Pc	Techno	8108	MA2_Trance 1	4/4	8	142	●		Psychedelic Kit
Dr/Pc	Techno	8109	MB2_Trance 1	4/4	4	142	●		:
Dr/Pc	Techno	8110	MC2_Trance 1	4/4	16	142	●		:
Dr/Pc	Techno	8111	FA2_Trance 1	4/4	2	142	●		:
Dr/Pc	Techno	8112	FB2_Trance 1	4/4	8	142	●		:
Dr/Pc	Techno	8113	FC2_Trance 1	4/4	8	142	●		:
Dr/Pc	Techno	8114	BA2_Trance 1	4/4	1	142	●		:
Dr/Pc	Techno	8115	MA_Trance 2	4/4	8	135	●		Trance Kit
Dr/Pc	Techno	8116	MB_Trance 2	4/4	8	135	●		:
Dr/Pc	Techno	8117	MC_Trance 2	4/4	8	135	●		:
Dr/Pc	Techno	8118	FA_Trance 2	4/4	1	135	●		:
Dr/Pc	Techno	8119	FB_Trance 2	4/4	8	135	●		:
Dr/Pc	Techno	8120	FC_Trance 2	4/4	1	135	●		:
Dr/Pc	Techno	8121	BA_Trance 2	4/4	1	135	●		:
Dr/Pc	Techno	8122	MA_8Z Trance 3	4/4	2	140	●		8Z Psychedelic 1
Dr/Pc	Techno	8123	MB_8Z Trance 3	4/4	2	140	●		:
Dr/Pc	Techno	8124	MC_8Z Trance 3	4/4	3	140	●		:
Dr/Pc	Techno	8125	FA_8Z Trance 3	4/4	2	140	●		:
Dr/Pc	Techno	8126	FB_8Z Trance 3	4/4	2	140	●		:
Dr/Pc	Techno	8127	FC_8Z Trance 3	4/4	4	140	●		:
Dr/Pc	Techno	8128	BA_8Z Trance 3	4/4	1	140	●		:
Dr/Pc	Techno	8129	MA_Trance 4	4/4	4	130	●		Analog T8 Kit
Dr/Pc	Techno	8130	MB_Trance 4	4/4	2	130	●		:
Dr/Pc	Techno	8131	MC_Trance 4	4/4	4	130	●		:
Dr/Pc	Techno	8132	FA_Trance 4	4/4	4	130	●		:
Dr/Pc	Techno	8133	FC_Trance 4	4/4	4	130	●		:
Dr/Pc	Techno	8134	BA_Trance 4	4/4	2	130	●		:
Dr/Pc	Techno	8135	MA_Trance 5	4/4	4	140	●		Analog T9 Kit
Dr/Pc	Techno	8136	MB_Trance 5	4/4	4	140	●		:
Dr/Pc	Techno	8137	MC_Trance 5	4/4	4	140	●		:
Dr/Pc	Techno	8138	MD_Trance 5	4/4	4	140	●		:
Dr/Pc	Techno	8139	IA_Trance 5	4/4	4	140	●		:
Dr/Pc	Techno	8140	FA_Trance 5	4/4	4	140	●		:
Dr/Pc	Techno	8141	FB_Trance 5	4/4	4	140	●		:
Dr/Pc	Techno	8142	FC_Trance 5	4/4	4	140	●		:
Dr/Pc	Techno	8143	ME_Trance 5/Bd1	4/4	4	140	●		:
Dr/Pc	Techno	8144	ME_Trance 5/Bd2	4/4	4	140	●		:
Dr/Pc	Techno	8145	ME_Trance 5/Bd3	4/4	4	140	●		:
Dr/Pc	Techno	8146	ME_Trance 5/Bd4	4/4	4	140	●		:
Dr/Pc	Techno	8147	ME_Trance 5/Hh1	4/4	4	140	●		:
Dr/Pc	Techno	8148	ME_Trance 5/Hh2	4/4	2	140	●		:
Dr/Pc	Techno	8149	ME_Trance 5/Hh3	4/4	1	140	●		:
Dr/Pc	Techno	8150	ME_Trance 5/Hh4	4/4	1	140	●		:
Dr/Pc	Techno	8151	ME_Trance 5/Hh5	4/4	1	140	●		:
Dr/Pc	Techno	8152	ME_Trance 5/Hh6	4/4	1	140	●		:
Dr/Pc	Techno	8153	ME_Trance 5/Hh7	4/4	1	140	●		:
Dr/Pc	Techno	8154	ME_Trance 5/Cip	4/4	4	140	●		:
Dr/Pc	Techno	8155	FD_Trance 5/Sdf	4/4	4	140	●		:
Dr/Pc	Techno	8156	MA1_PsycheTrance	4/4	4	143	●		Psychedelic Kit
Dr/Pc	Techno	8157	MB1_PsycheTrance	4/4	2	143	●		:
Dr/Pc	Techno	8158	MC1_PsycheTrance	4/4	2	143	●		:
Dr/Pc	Techno	8159	MD1_PsycheTrance	4/4	4	143	●		:
Dr/Pc									

Main Category	Sub Category	ARP No.	ARP Name	Time Signature	Length	Original Tempo	Accent	Random SFX	Sound Type
Dr/Pc	Techno	8177	FB3_8Z Psyche	4/4	1	135	●		:
Dr/Pc	Techno	8178	FC3_8Z Psyche	4/4	1	135	●		:
Dr/Pc	Techno	8179	BA3_8Z Psyche	4/4	1	135	●		:
Dr/Pc	Techno	8180	MA_Trance Kit 1	4/4	4	136	●		Trance Kit
Dr/Pc	Techno	8181	MA_Trance Kit 2	4/4	4	136	●		:
Dr/Pc	Techno	8182	MA_Trance Kit 3	4/4	4	136	●		:
Dr/Pc	Techno	8183	MA_Trance Kit 4	4/4	4	136	●		:
Dr/Pc	Techno	8184	MA_Trance Kit 5	4/4	4	136	●		:
Dr/Pc	Techno	8185	MA_Trance Kit 6	4/4	4	136	●		:
Dr/Pc	Techno	8186	MA_Trance Kit 7	4/4	1	136	●		:
Dr/Pc	Techno	8187	MA_Trance Kit 8	4/4	2	136	●		:
Dr/Pc	Techno	8188	MA_Trance Kit 9	4/4	2	136	●		:
Dr/Pc	Techno	8189	MA_Trance Kit10	4/4	2	136	●		:
Dr/Pc	Techno	8190	MA_Trance Kit11	4/4	2	136	●		:
Dr/Pc	Techno	8191	MA_Trance Kit12	4/4	4	136	●		:
Dr/Pc	Techno	8192	MA_8Z TrancBsc1	4/4	1	136	●		8Z Trance Basics
Dr/Pc	Techno	8193	MA_8Z TrancBsc2	4/4	1	136	●		:
Dr/Pc	Techno	8194	MA_8Z TrancBsc3	4/4	1	136	●		:
Dr/Pc	Techno	8195	MA_8Z TrancBsc4	4/4	1	136	●		:
Dr/Pc	Techno	8196	MA_8Z TrancBsc5	4/4	4	136	●		:
Dr/Pc	Techno	8197	MA_Trance Club1	4/4	1	128	●		Trance Kit
Dr/Pc	Techno	8198	MA_Trance Club2	4/4	1	128	●		:
Dr/Pc	Techno	8199	MA_Trance Club3	4/4	1	128	●		:
Dr/Pc	Techno	8200	MA_Trance Club4	4/4	1	128	●		:
Dr/Pc	Techno	8201	MA_Trance Club5	4/4	1	128	●		:
Dr/Pc	Techno	8202	MA_Trance Club6	4/4	1	128	●		:
Dr/Pc	Techno	8203	MA_Trance Vision	4/4	4	134	●		8Z Trance Basics 2
Dr/Pc	Techno	8204	MB_Trance Vision	4/4	4	134	●		:
Dr/Pc	Techno	8205	MC_Trance Vision	4/4	8	134	●		:
Dr/Pc	Techno	8206	MD_Trance Vision	4/4	4	134	●		:
Dr/Pc	Techno	8207	ME_Trance Vision	4/4	4	134	●		:
Dr/Pc	Techno	8208	MF_Trance Vision	4/4	4	134	●		:
Dr/Pc	Techno	8209	MG_Trance Vision	4/4	4	134	●		:
Dr/Pc	Techno	8210	MH_Trance Vision	4/4	4	134	●		:
Dr/Pc	Techno	8211	MA_Dream Trance	4/4	4	140	●		:
Dr/Pc	Techno	8212	MB_Dream Trance	4/4	4	140	●		:
Dr/Pc	Techno	8213	MC_Dream Trance	4/4	4	140	●		:
Dr/Pc	Techno	8214	MD_Dream Trance	4/4	4	140	●		:
Dr/Pc	Techno	8215	MA_MagneticTrance	4/4	4	130	●		8Z Jarrin
Dr/Pc	Techno	8216	MB_MagneticTrance	4/4	4	130	●		:
Dr/Pc	Techno	8217	MC_MagneticTrance	4/4	4	130	●		:
Dr/Pc	Techno	8218	MD_MagneticTrance	4/4	4	130	●		:
Dr/Pc	Techno	8219	MA_Electrix	4/4	2	119	●		Wacko Kit
Dr/Pc	Techno	8220	MB_Electrix	4/4	2	119	●		:
Dr/Pc	Techno	8221	MC_Electrix	4/4	2	119	●		:
Dr/Pc	Techno	8222	MD_Electrix	4/4	2	119	●		:
Dr/Pc	Techno	8223	ME_Electrix	4/4	2	119	●		:
Dr/Pc	Techno	8224	FA_Electrix	4/4	1	119	●		:
Dr/Pc	Techno	8225	MA_Cool Breakz	4/4	2	116	●		8Z Tom Heartz
Dr/Pc	Techno	8226	MB_Cool Breakz	4/4	2	116	●		:
Dr/Pc	Techno	8227	MC_Cool Breakz	4/4	2	116	●		:
Dr/Pc	Techno	8228	FA_Cool Breakz	4/4	2	116	●		:
Dr/Pc	Techno	8229	FB_Cool Breakz	4/4	2	116	●		:
Dr/Pc	Techno	8230	FC_Cool Breakz	4/4	2	116	●		:
Dr/Pc	Techno	8231	MA_8Z EriyLoFi1	4/4	1	136	●		8Z Early Lo-Fi
Dr/Pc	Techno	8232	MA_8Z EriyLoFi2	4/4	1	136	●		:
Dr/Pc	Techno	8233	MA_8Z EriyLoFi3	4/4	1	136	●		:
Dr/Pc	Techno	8234	MA_8Z EriyLoFi4	4/4	1	136	●		:
Dr/Pc	Techno	8235	MA_8Z EriyLoFi5	4/4	1	136	●		:
Dr/Pc	Techno	8236	MA_8Z NoiseXpr1	4/4	4	136	●		8Z Noise Xpress
Dr/Pc	Techno	8237	MA_8Z NoiseXpr2	4/4	4	136	●		:
Dr/Pc	Techno	8238	MA_8Z NoiseXpr3	4/4	4	136	●		:
Dr/Pc	Techno	8239	MA_8Z NoiseXpr4	4/4	4	136	●		:
Dr/Pc	Techno	8240	MA_8Z NoiseXpr5	4/4	4	136	●		:
Dr/Pc	Techno	8241	MA_8Z ReversB11	4/4	1	136	●		8Z Reverse Beatz
Dr/Pc	Techno	8242	MA_8Z ReversB12	4/4	1	136	●		:
Dr/Pc	Techno	8243	MA_8Z ReversB13	4/4	1	136	●		:
Dr/Pc	Techno	8244	MA_8Z ReversB14	4/4	1	136	●		:
Dr/Pc	Techno	8245	MA_8Z CrushDnc1	4/4	2	136	●		8Z Crush Dance
Dr/Pc	Techno	8246	MA_8Z CrushDnc2	4/4	2	136	●		:
Dr/Pc	Techno	8247	MA_8Z CrushDnc3	4/4	4	136	●		:
Dr/Pc	Techno	8248	MA_8Z CrushDnc4	4/4	2	136	●		:
Dr/Pc	Techno	8249	MA_8Z CrushDnc5	4/4	4	136	●		:
Dr/Pc	Techno	8250	MA_16thMelodicPerc1	4/4	2	140	●		Hip Hop Kit 1
Dr/Pc	Techno	8251	MA_16thMelodicPerc2	4/4	2	140	●		:
Dr/Pc	Techno	8252	MA_16thMelodicPerc3	4/4	2	140	●		:
Dr/Pc	Techno	8253	MA_16thMelodicPerc4	4/4	2	140	●		:
Dr/Pc	House	8254	*1 MA_EDM Chart 1-1	4/4	4	122	●		Dancefloor Kit
Dr/Pc	House	8255	*1 MA_EDM Chart 2-1	4/4	4	120	●		T's EDM Kit
Dr/Pc	House	8256	*1 MA_EDM Chart 2-2	4/4	4	93	●		Dancefloor Kit
Dr/Pc	House	8257	*1 MA_EDM Chart 3-1	4/4	4	80	●		DUB Kit
Dr/Pc	House	8258	*1 MA_EDM Chart 4-1	4/4	3	102	●		:
Dr/Pc	House	8259	*1 MA_EDM Chart 4-2	4/4	2	96	●		:
Dr/Pc	House	8260	*1 MA_EDM Chart 4-3	4/4	2	96	●		:
Dr/Pc	House	8261	*1 MA_EDM Chart 5-1	4/4	4	129	●		Dancefloor Kit
Dr/Pc	House	8262	*1 MA_EDM Chart 5-2	4/4	4	97	●		:
Dr/Pc	House	8263	*1 MA_EDM Chart 6	4/4	4	75	●		T's EDM Kit

Main Category	Sub Category	ARP No.	ARP Name	Time Signature	Length	Original Tempo	Accent	Random SFX	Sound Type
Dr/Pc	House	8264	*1 MA_EDM Chart 7	4/4	4	113	●		:
Dr/Pc	House	8265	*1 MA_EDM Electro 1	4/4	4	145	●		:
Dr/Pc	House	8266	*1 MA_EDM Electro 2	4/4	4	146	●		:
Dr/Pc	House	8267	*1 MA_EDM Electro 3	4/4	4	123	●		:
Dr/Pc	House	8268	*1 MA_EDM Electro 4	4/4	4	123	●		Electro Kit
Dr/Pc	House	8269	*1 MA_Strobo Cop	4/4	4	120	●		T's EDM Kit
Dr/Pc	House	8270	*1 MB_Strobo Cop	4/4	4	120	●		:
Dr/Pc	House	8271	*1 MC_Strobo Cop	4/4	4	120	●		:
Dr/Pc	House	8272	*1 MD_Strobo Cop	4/4	4	120	●		:
Dr/Pc	House	8273	*1 MA_Garnier Street	4/4	4	123	●		Electro Kit
Dr/Pc	House	8274	*1 MA_Love Town	4/4	2	122	●		:
Dr/Pc	House	8275	*1 MA_Deep Lo	4/4	2	126	●		T's Hip Hop Kit
Dr/Pc	House	8276	*1 MA_Who's House	4/4	1	122	●		EDM Kit
Dr/Pc	House	8277	*1 MA_Shoot 4 TheStars	4/4	1	122	●		House-Techno Kit
Dr/Pc	House	8278	*1 MA_EDM Garage 1	4/4	4	123	●		Dancefloor Kit
Dr/Pc	House	8279	*1 MA_EDM Garage 2	4/4	4	123	●		:
Dr/Pc	House	8280	*1 MA_EDM Garage 3	4/4	4	123	●		Electro Kit
Dr/Pc	House	8281	*1 MA_EDM Urban 1	4/4	4	104	●		T's EDM Kit
Dr/Pc	House	8282	*1 MA_EDM Urban 2	4/4	2	87	●		Electro Kit
Dr/Pc	House	8283	*1 MA_EDM Urban 3	4/4	1	87	●		:
Dr/Pc	House	8284	*1 MA_Tropical House 1	4/4	4	102	●		House-Techno Kit
Dr/Pc	House	8285	*1 MA_Tropical House 2	4/4	4	100	●		:
Dr/Pc	House	8286	*1 MA_Tropical House 3	4/4	4	105	●		:
Dr/Pc	House	8287	*1 MA_Tropical House 4	4/4	4	115	●		Dancefloor Kit
Dr/Pc	House	8288	*1 MA_Island Breeze	4/4	2	100	●		DUB Kit
Dr/Pc	House	8289	*1 MA_Chill Water	4/4	4	93	●		Downtempo HipHop Kit
Dr/Pc	House	8290	*1 MA_The Crew	4/4	2	102	●		Trap Kit
Dr/Pc	House	8291	*1 MA_Smoke Screen	4/4	2	109	●		Electro Kit
Dr/Pc	House	8292	*1 MA_The Stomp Three	4/4	2	89	●		T's Hip Hop Kit
Dr/Pc	House	8293	*1 MA_EDM DanceHall 1	4/4	4	98	●		DUB Kit
Dr/Pc	House	8294	*1 MA_EDM DanceHall 2	4/4	4	100	●		House-Techno Kit
Dr/Pc	House	8295	*1 MA_EDM DanceHall 3	4/4	4	100	●		:
Dr/Pc	House	8296	*1 MA_Readhead	4/4	4	97	●		Electro Kit
Dr/Pc	House	8297	*1 MA_Island 1	4/4	4	100	●		T's Hip Hop Kit
Dr/Pc	House	8298	*1 MA_Island 2	4/4	4	100	●		:
Dr/Pc	House	8299	*1 MA_Island 3	4/4	4	100	●		:
Dr/Pc	House	8300	*1 MA_Slouch	4/4	4	89	●		:
Dr/Pc	House	8301	*1 MA_The Stomp Two	4/4	2	90	●		:
Dr/Pc	House	8302	*1 MA_The Job	4/4	4	93	●		DUB Kit
Dr/Pc	House	8303	*1 MA_Festival Dance	4/4	2	115	●		Dancefloor Kit
Dr/Pc	House	8304	*1 MA_Future Retro	4/4	4	84	●		Electro Kit
Dr/Pc	House	8305	*1 MA_You	4/4	4	78	●		European EDM Kit 2
Dr/Pc	House	8306	*1 MB_You	4/4	4	77	●		:
Dr/Pc	House	8307	*1 MA_Hospital	4/4	4	120	●		T's Hip Hop Kit
Dr/Pc	House	8308	*1 MA_Origin	4/4	4	110	●		:
Dr/Pc	House	8309	*1 MA_hehe	4/4	4	130	●		T's EDM Kit
Dr/Pc	House	8310	MA_EDM Drum 01	4/4	1	130	●		European EDM Kit 1
Dr/Pc	House	8311	MA_EDM Drum 02	4/4	1	130	●		:
Dr/Pc	House	8312	MA_EDM Drum 03	4/4	2	130	●		:
Dr/Pc	House	8313	MA_EDM Drum 04	4/4	2	130	●		:
Dr/Pc	House	8314	MA_EDM Drum 05	4/4	2	130	●		:
Dr/Pc	House	8315	MA_EDM Drum 06	4/4	2	130	●		:
Dr/Pc	House	8316	MA_EDM Drum 07	4/4	2	130	●		:
Dr/Pc	House	8317	MA_EDM Drum 08	4/4	2	130	●		:
Dr/Pc	House	8318	MA_EDM Drum 09	4/4	2	130	●		:
Dr/Pc	House	8319	MA_EDM Drum 10	4/4	2	130	●		:
Dr/Pc	House	8320	MA_EDM Drum 11	4/4	2	130	●		:
Dr/Pc	House	8321	MA_EDM Drum 12	4/4	2	130	●		:
Dr/Pc	House	8322	MA_EDM Drum 13	4/4	2	130	●		:
Dr/Pc	House	8323	MA_Dance Floor 1-1	4/4	1	130	●		:
Dr/Pc	House	8324	MA_Dance Floor 1-2	4/4	1	130	●		:
Dr/Pc	House	8325	MA_Dance Floor 1-3	4/4	1	130	●		:
Dr/Pc	House	8326	MA_Dance Floor 1-4	4/4	1	130	●		:
Dr/Pc	House	8327	MA_Dance Floor 1-5	4/4	1	130	●		:
Dr/Pc	House	8328	MA_Dance Floor 2-1	4/4	1	130	●		:
Dr/Pc	House	8329	MA_Dance Floor 2-2	4/4	1	130	●		:
Dr/Pc	House	8330	MA_Dance Floor 2-3	4/4	1	130	●		:
Dr/Pc	House	8331	MA_Dance Floor 2-4	4/4	1	130	●		:
Dr/Pc	House	8332	MA_Dance Floor 2-5	4/4	1	130	●		:</

Main Category	Sub Category	ARP No.	ARP Name	Time Signature	Length	Original Tempo	Accent	Random SFX	Sound Type
Dr/Pc	House	8351	MA_Straight Up	4/4	4	120	●		:
Dr/Pc	House	8352	MA_The Count	4/4	4	125	●		:
Dr/Pc	House	8353	MA_Clap Em	4/4	4	128	●		:
Dr/Pc	House	8354	MA_Hamtramck Funk	4/4	4	130	●		:
Dr/Pc	House	8355	MA_4 Here Or 2 Go	4/4	4	124	●		Nu Hip Hop Kit 1
Dr/Pc	House	8356	MA_Dollar Break	4/4	1	84	●		EDM Kit
Dr/Pc	House	8357	MA_Bakin	4/4	2	122	●		:
Dr/Pc	House	8358	MA_Bookin	4/4	1	122	●		:
Dr/Pc	House	8359	MA_Berlin	4/4	4	128	●		:
Dr/Pc	House	8360	MA_River Tech	4/4	4	128	●		:
Dr/Pc	House	8361	MA_Shake Down	4/4	4	128	●		:
Dr/Pc	House	8362	MA_Smackin	4/4	2	128	●		:
Dr/Pc	House	8363	MA_Snare Roll	4/4	4	128	●		:
Dr/Pc	House	8364	MA_Snare Stalker	4/4	4	150	●		:
Dr/Pc	House	8365	MA_UpSweeper	4/4	4	128	●		:
Dr/Pc	House	8366	MA_One Bar Jay	4/4	1	133	●		:
Dr/Pc	House	8367	MA_Swing Set	4/4	2	133	●		:
Dr/Pc	House	8368	MA_Chopper	4/4	2	140	●		:
Dr/Pc	House	8369	MA_Derb Step 1	4/4	1	140	●		:
Dr/Pc	House	8370	MA_Derb Step 2	4/4	2	140	●		:
Dr/Pc	House	8371	MA_Lightness	4/4	2	140	●		:
Dr/Pc	House	8372	MA_Snake Step	4/4	4	140	●		:
Dr/Pc	House	8373	MA_Octo Cooler	4/4	4	150	●		:
Dr/Pc	House	8374	MA_Hands Off	4/4	2	125	●		House-Techno Kit
Dr/Pc	House	8375	MA_Hands On	4/4	2	125	●		:
Dr/Pc	House	8376	MA_Hat Swag	4/4	2	128	●		:
Dr/Pc	House	8377	MA_Beat Stealer	4/4	2	128	●		:
Dr/Pc	House	8378	MA_Beatbox	4/4	2	128	●		:
Dr/Pc	House	8379	MA_Broken Chair	4/4	2	128	●		:
Dr/Pc	House	8380	MA_Clap 2 This	4/4	2	128	●		:
Dr/Pc	House	8381	MA_Cream Filled	4/4	4	128	●		:
Dr/Pc	House	8382	MA_Just The BD	4/4	2	128	●		:
Dr/Pc	House	8383	MA_Just The BD & SD	4/4	2	128	●		:
Dr/Pc	House	8384	MA_MarvinOscillator	4/4	2	128	●		:
Dr/Pc	House	8385	MA_Snare Builder	4/4	2	128	●		:
Dr/Pc	House	8386	MA_Straight Knock	4/4	2	128	●		:
Dr/Pc	House	8387	MA_Street Creep	4/4	2	128	●		:
Dr/Pc	House	8388	MA_Street Sweep	4/4	4	128	●		:
Dr/Pc	House	8389	MA_Strobe Drums	4/4	1	128	●		:
Dr/Pc	House	8390	MA_The Bottom	4/4	2	128	●		:
Dr/Pc	House	8391	MA_Tom Foolery One	4/4	2	128	●		:
Dr/Pc	House	8392	MA_Tom Foolery Two	4/4	2	128	●		:
Dr/Pc	House	8393	MA_Wood Funk	4/4	2	128	●		:
Dr/Pc	House	8394	MA_Work The Buttons	4/4	2	128	●		:
Dr/Pc	House	8395	MA_Try Not Three	4/4	2	115	●		Electro Kit
Dr/Pc	House	8396	MA_Try Not Two	4/4	1	115	●		:
Dr/Pc	House	8397	MA_All Systems Go	4/4	1	118	●		:
Dr/Pc	House	8398	MA_Work That	4/4	1	118	●		:
Dr/Pc	House	8399	MA_Wreck New Jack	4/4	2	118	●		:
Dr/Pc	House	8400	MA_Wreck No Kick	4/4	1	118	●		:
Dr/Pc	House	8401	MA_Pacific Beat	4/4	2	122	●		:
Dr/Pc	House	8402	MA_Sprague Beat	4/4	2	122	●		:
Dr/Pc	House	8403	MA_Gratiot Beat	4/4	1	125	●		:
Dr/Pc	House	8404	MA_Hard Motion	4/4	1	125	●		:
Dr/Pc	House	8405	MA_Gators	4/4	2	125	●		:
Dr/Pc	House	8406	MA_Lasers	4/4	2	125	●		:
Dr/Pc	House	8407	MA_Raiders	4/4	1	125	●		:
Dr/Pc	House	8408	MA_Rogue Beug	4/4	1	125	●		:
Dr/Pc	House	8409	MA_Spanish Frog	4/4	2	125	●		:
Dr/Pc	House	8410	MA_Zap Maverick	4/4	1	125	●		:
Dr/Pc	House	8411	MA_Zap Naton	4/4	1	125	●		:
Dr/Pc	House	8412	MA_Clap 2 TheFuture	4/4	2	130	●		:
Dr/Pc	House	8413	MA_Lay It Down	4/4	2	130	●		:
Dr/Pc	House	8414	MA_Movin Up	4/4	1	130	●		:
Dr/Pc	House	8415	MA_Burning Up	4/4	4	128	●		T's EDM Kit
Dr/Pc	House	8416	MA_All Together 1	4/4	4	128	●		:
Dr/Pc	House	8417	MA_All Together 2	4/4	4	128	●		:
Dr/Pc	House	8418	MA_B2L	4/4	4	122	●		:
Dr/Pc	House	8419	MA_Cassette Deck	4/4	4	130	●		:
Dr/Pc	House	8420	MA_Like To Build	4/4	4	130	●		:
Dr/Pc	House	8421	MA_MausTrap	4/4	4	130	●		:
Dr/Pc	House	8422	MA_MotorSkills	4/4	4	135	●		:
Dr/Pc	House	8423	MA_UpJUMP	4/4	4	128	●		:
Dr/Pc	House	8424	MA_Dream Dance	4/4	4	136	●		House Kit 1
Dr/Pc	House	8425	MC_Dream Dance	4/4	4	136	●		:
Dr/Pc	House	8426	MD_Dream Dance	4/4	4	136	●		:
Dr/Pc	House	8427	IA_Dream Dance	4/4	4	136	●		:
Dr/Pc	House	8428	ME_Dream Dance/Bd1	4/4	4	136	●		:
Dr/Pc	House	8429	ME_Dream Dance/Bd2	4/4	4	136	●		:
Dr/Pc	House	8430	ME_Dream Dance/Bd3	4/4	4	136	●		:
Dr/Pc	House	8431	ME_Dream Dance/Bd4	4/4	4	136	●		:
Dr/Pc	House	8432	ME_Dream Dance/Bd5	4/4	4	136	●		:
Dr/Pc	House	8433	ME_Dream Dance/Hh1	4/4	1	136	●		:
Dr/Pc	House	8434	ME_Dream Dance/Hh2	4/4	4	136	●		:
Dr/Pc	House	8435	ME_Dream Dance/Hh3	4/4	2	136	●		:
Dr/Pc	House	8436	ME_Dream Dance/Hh4	4/4	4	136	●		Analog T8 Kit
Dr/Pc	House	8437	ME_Dream Dance/Clp	4/4	4	136	●		House Kit 1

Main Category	Sub Category	ARP No.	ARP Name	Time Signature	Length	Original Tempo	Accent	Random SFX	Sound Type
Dr/Pc	House	8438	ME_Dream Dance/Pc1	4/4	4	136	●		Percussion Kit
Dr/Pc	House	8439	ME_Dream Dance/Pc2	4/4	2	136	●		Analog T8 Kit
Dr/Pc	House	8440	ME_Dream Dance/Pc3	4/4	4	136	●		:
Dr/Pc	House	8441	FA_Dream Dance/Sdf	4/4	4	136	●		House Kit 1
Dr/Pc	House	8442	MA1_Ibiza	4/4	2	135	●		:
Dr/Pc	House	8443	MB1_Ibiza	4/4	2	135	●		:
Dr/Pc	House	8444	MC1_Ibiza	4/4	2	135	●		:
Dr/Pc	House	8445	MD1_Ibiza	4/4	2	135	●		:
Dr/Pc	House	8446	IA1_Ibiza	4/4	8	135	●		:
Dr/Pc	House	8447	FA1_Ibiza	4/4	1	135	●		:
Dr/Pc	House	8448	FB1_Ibiza	4/4	1	135	●		:
Dr/Pc	House	8449	FC1_Ibiza	4/4	2	135	●		:
Dr/Pc	House	8450	MA2_Ibiza	4/4	2	135	●		Dry Standard Kit
Dr/Pc	House	8451	FB2_Ibiza	4/4	1	135	●		Dry Standard Kit (PB Range=24)
Dr/Pc	House	8452	MA_Retro Pop	4/4	1	126	●		House Kit 1
Dr/Pc	House	8453	MC_Retro Pop	4/4	2	126	●		:
Dr/Pc	House	8454	FC_Retro Pop	4/4	1	126	●		:
Dr/Pc	House	8455	MA_Euro Teck	4/4	2	140	●		Tekno Kit
Dr/Pc	House	8456	MB_Euro Teck	4/4	2	140	●		:
Dr/Pc	House	8457	MC_Euro Teck	4/4	2	140	●		:
Dr/Pc	House	8458	MD_Euro Teck	4/4	2	140	●		:
Dr/Pc	House	8459	ME_Euro Teck	4/4	2	140	●		:
Dr/Pc	House	8460	MA_Disco House	4/4	4	126	●		Acid Kit
Dr/Pc	House	8461	MB_Disco House	4/4	4	126	●		:
Dr/Pc	House	8462	MC_Disco House	4/4	4	126	●		:
Dr/Pc	House	8463	FA_Disco House	4/4	1	126	●		:
Dr/Pc	House	8464	FB_Disco House	4/4	1	126	●		:
Dr/Pc	House	8465	FC_Disco House	4/4	1	126	●		:
Dr/Pc	House	8466	BA_Disco House	4/4	1	126	●		:
Dr/Pc	House	8467	MA1_Club House	4/4	1	128	●		House Kit 1
Dr/Pc	House	8468	MB1_Club House	4/4	1	128	●		:
Dr/Pc	House	8469	MC1_Club House	4/4	1	128	●		:
Dr/Pc	House	8470	MD1_Club House	4/4	1	128	●		:
Dr/Pc	House	8471	IA1_Club House	4/4	2	128	●		:
Dr/Pc	House	8472	FA1_Club House	4/4	1	128	●		:
Dr/Pc	House	8473	FB1_Club House	4/4	1	128	●		:
Dr/Pc	House	8474	FC1_Club House	4/4	2	128	●		:
Dr/Pc	House	8475	MD2_Club House	4/4	1	128	●		Hyper Standard Kit
Dr/Pc	House	8476	IA2_Club House	4/4	1	128	●		House Kit 1
Dr/Pc	House	8477	FB2_Club House	4/4	1	128	●		Hyper Standard Kit
Dr/Pc	House	8478	MA_House 1	4/4	2	123	●		Analog T9 Kit
Dr/Pc	House	8479	MA_House 2	4/4	1	123	●		Garage Kit
Dr/Pc	House	8480	MA_House 3	4/4	2	127	●		:
Dr/Pc	House	8481	MA_House 4	4/4	2	130	●		Hip Hop Kit 3
Dr/Pc	House	8482	MB_House 4	4/4	2	130	●		:
Dr/Pc	House	8483	MC_House 4	4/4	2	130	●		:
Dr/Pc	House	8484	MA_House 5	4/4	4	120	●		House Kit 1
Dr/Pc	House	8485	MB_House 5	4/4	1	120	●		:
Dr/Pc	House	8486	MC_House 5	4/4	1	120	●		:
Dr/Pc	House	8487	MD_House 5	4/4	1	120	●		:
Dr/Pc	House	8488	MA_House 6	4/4	1	120	●		:
Dr/Pc	House	8489	MB_House 6	4/4	1	120	●		:
Dr/Pc	House	8490	MC_House 6	4/4	1	120	●		:
Dr/Pc	House	8491	MA_House 7	4/4	1	120	●		:
Dr/Pc	House	8492	MB_House 7	4/4	1	120	●		:
Dr/Pc	House	8493	MA_House 8	4/4	2	120	●		:
Dr/Pc	House	8494	MA_House 9	4/4	4	120	●		:
Dr/Pc	House	8495	MA_House 10	4/4	1	120	●		:
Dr/Pc	House	8496	MB_House 10	4/4	1	120	●		:
Dr/Pc	House	8497	MA_House 11	4/4	1	120	●		:
Dr/Pc	House	8498	MB_House 11	4/4	1	120	●		:
Dr/Pc	House	8499	MC_House 11	4/4	1	120	●		:
Dr/Pc	House	8500	MA_House 12	4/4	2	120	●		:
Dr/Pc	House	8501	MA_House 13	4/4	2	120	●		:
Dr/Pc	House	8502	MA_House 14	4/4	1	123	●		:
Dr/Pc	House	8503	MA_House 15	4/4	2	128	●		:
Dr/Pc	House	8504	MA_Garage 1	4/4	2	130	●		Garage Kit
Dr/Pc	House	8505	MA_Garage 2	4/4	2	127	●		House Kit 1
Dr/Pc	House	8506	MB_Garage 2	4/4	2	127	●		:
Dr/Pc	House	8507	MC_Garage 2	4/4	2	127	●		:
Dr/Pc	House	8508	MD_Garage 2	4/4	2	127	●		:
Dr/Pc	House	8509	IA_Garage 2/a	4/4	1	127	●		:
Dr/Pc	House	8510	IA_Garage 2/b	4/4	1	127	●		:
Dr/Pc	House	8511	FA_Garage 2	4/4	1	127	●		:
Dr/Pc	House	851							

Main Category	Sub Category	ARP No.	ARP Name	Time Signature	Length	Original Tempo	Accent	Random SFX	Sound Type
Dr/Pc	D&B	8524	*1 MA_EDM DrumStep 2-1	4/4	4	174	●		T's EDM Kit
Dr/Pc	D&B	8525	*1 MA_EDM DrumStep 2-2	4/4	4	160	●		:
Dr/Pc	D&B	8526	*1 MA_EDM DrumStep 2-3	4/4	4	176	●		:
Dr/Pc	D&B	8527	*1 MA_EDM DrumStep 3-1	4/4	4	174	●		Dancefloor Kit
Dr/Pc	D&B	8528	*1 MA_EDM DrumStep 3-2	4/4	4	174	●		:
Dr/Pc	D&B	8529	*1 MA_EDM DubStep 1	4/4	4	152	●		DUB Kit
Dr/Pc	D&B	8530	*1 MA_EDM DubStep 2	4/4	4	150	●		Dancefloor Kit
Dr/Pc	D&B	8531	*1 MA_EDM DubStep 3	4/4	4	150	●		:
Dr/Pc	D&B	8532	*1 MA_Grime 1	4/4	4	139	●		Trap Kit
Dr/Pc	D&B	8533	*1 MA_Grime 2	4/4	4	140	●		:
Dr/Pc	D&B	8534	*1 MA_Grime 3	4/4	4	129	●		:
Dr/Pc	D&B	8535	*1 MA_Grime 4	4/4	4	140	●		:
Dr/Pc	D&B	8536	*1 MA_Grime 5	4/4	4	140	●		House-Techno Kit
Dr/Pc	D&B	8537	*1 MA_Grime 6	4/4	4	140	●		:
Dr/Pc	D&B	8538	*1 MA_Future Bass 1-1	4/4	4	102	●		Trap Kit
Dr/Pc	D&B	8539	*1 MA_Future Bass 1-2	4/4	4	102	●		:
Dr/Pc	D&B	8540	*1 MA_Future Bass 1-3	4/4	4	103	●		EDM Kit
Dr/Pc	D&B	8541	*1 MA_Future Bass 2-1	4/4	4	80	●		Trap Kit
Dr/Pc	D&B	8542	*1 MA_Future Bass 2-2	4/4	4	69	●		:
Dr/Pc	D&B	8543	*1 MA_Future Bass HH 1	4/4	4	92	●		Dancefloor Kit
Dr/Pc	D&B	8544	*1 MA_Future Bass HH 2	4/4	4	100	●		:
Dr/Pc	D&B	8545	*1 MA_Amad	4/4	4	160	●		Trap Kit
Dr/Pc	D&B	8546	MA_Complexro Dr 1	4/4	4	140	●		Psychedelic Dub Kit
Dr/Pc	D&B	8547	MA_Complexro Dr 2	4/4	4	140	●		:
Dr/Pc	D&B	8548	MA_Complexro Dr 3	4/4	4	140	●		:
Dr/Pc	D&B	8549	MA_Complexro Dr 4	4/4	4	140	●		:
Dr/Pc	D&B	8550	MA_Complexro Dr 5	4/4	4	140	●		:
Dr/Pc	D&B	8551	MA_Complexro Dr 6	4/4	4	140	●		:
Dr/Pc	D&B	8552	MA_PsychoDub Dr 1	4/4	4	140	●		:
Dr/Pc	D&B	8553	MA_PsychoDub Dr 2	4/4	4	140	●		:
Dr/Pc	D&B	8554	MA_PsychoDub Dr 3	4/4	4	140	●		:
Dr/Pc	D&B	8555	MA_PsychoDub Dr 4	4/4	4	140	●		:
Dr/Pc	D&B	8556	MA_PsychoDub Dr 5	4/4	4	140	●		:
Dr/Pc	D&B	8557	MA_PsychoDub Dr 6	4/4	4	140	●		:
Dr/Pc	D&B	8558	MA_DubStep Basic 1A	4/4	4	140	●		:
Dr/Pc	D&B	8559	MA_DubStep Basic 1B	4/4	4	140	●		:
Dr/Pc	D&B	8560	MA_DubStep Basic 2	4/4	4	140	●		:
Dr/Pc	D&B	8561	MA_DubStep Basic 3A	4/4	4	140	●		:
Dr/Pc	D&B	8562	MA_DubStep Basic 3B	4/4	4	140	●		:
Dr/Pc	D&B	8563	MA_DubStep Basic 3C	4/4	4	140	●		:
Dr/Pc	D&B	8564	MA_DubStep Basic 4A	4/4	4	140	●		:
Dr/Pc	D&B	8565	MA_DubStep Basic 4B	4/4	4	140	●		:
Dr/Pc	D&B	8566	MA_DubStep Basic 5	4/4	4	140	●		:
Dr/Pc	D&B	8567	MA_DubStep Basic 6	4/4	4	140	●		:
Dr/Pc	D&B	8568	MA_DubStep Basic 7	4/4	4	140	●		:
Dr/Pc	D&B	8569	MA_DubStep Basic 8A	4/4	4	140	●		:
Dr/Pc	D&B	8570	MA_DubStep Basic 8B	4/4	4	140	●		:
Dr/Pc	D&B	8571	MA_DubStep Basic 8C	4/4	4	140	●		:
Dr/Pc	D&B	8572	MA_Drums perc 4	4/4	2	160	●		Distorted Kit
Dr/Pc	D&B	8573	MA_Drums perc 5	4/4	2	160	●		:
Dr/Pc	D&B	8574	MA_Drums perc 6	4/4	2	160	●		:
Dr/Pc	D&B	8575	MA_Drums perc 7	4/4	2	160	●		:
Dr/Pc	D&B	8576	MA_Drums perc 8	4/4	2	175	●		:
Dr/Pc	D&B	8577	MA_Drums perc 9	4/4	2	160	●		:
Dr/Pc	D&B	8578	MA_Drums perc 10	4/4	2	175	●		:
Dr/Pc	D&B	8579	MA_Drums perc 11-1	4/4	2	175	●		:
Dr/Pc	D&B	8580	MA_Drums perc 11-2	4/4	2	175	●		:
Dr/Pc	D&B	8581	MA_Bass Drop	4/4	4	101	●		T's EDM Kit
Dr/Pc	D&B	8582	MA_On Fleek 1	4/4	4	104	●		:
Dr/Pc	D&B	8583	MA_On Fleek 2	4/4	4	104	●		:
Dr/Pc	D&B	8584	MA_Trap Hard	4/4	4	106	●		:
Dr/Pc	D&B	8585	MA_TrpGod	4/4	4	160	●		:
Dr/Pc	D&B	8586	MA_Electro Boo	4/4	4	125	●		Synth Pop Kit
Dr/Pc	D&B	8587	MA_Roll Away	4/4	8	155	●		Dance Snares
Dr/Pc	D&B	8588	MA_Basic Dubz	4/4	4	140	●		Electronic Type Kit
Dr/Pc	D&B	8589	MA_Brake Fast	4/4	4	140	●		:
Dr/Pc	D&B	8590	MA_Havoc	4/4	2	140	●		:
Dr/Pc	D&B	8591	MA_Hobbs Riddim	4/4	4	140	●		:
Dr/Pc	D&B	8592	MA_Jefferson Dub	4/4	1	140	●		:
Dr/Pc	D&B	8593	MA_Knocksmith	4/4	2	140	●		:
Dr/Pc	D&B	8594	MA_Light Rail	4/4	4	140	●		:
Dr/Pc	D&B	8595	MA_Lord of the Rides	4/4	4	140	●		:
Dr/Pc	D&B	8596	MA_MB1F Dub	4/4	2	140	●		:
Dr/Pc	D&B	8597	MA_Ring Master	4/4	2	140	●		:
Dr/Pc	D&B	8598	MA_Roller	4/4	2	140	●		:
Dr/Pc	D&B	8599	MA_Sea Light	4/4	2	140	●		:
Dr/Pc	D&B	8600	MA_Space Twerk	4/4	4	140	●		:
Dr/Pc	D&B	8601	MA_Tom Bomb	4/4	2	140	●		:
Dr/Pc	D&B	8602	MA_Tom's Beat	4/4	1	140	●		:
Dr/Pc	D&B	8603	MA_Tribe Whylin	4/4	2	140	●		:
Dr/Pc	D&B	8604	MA_Vapor	4/4	2	140	●		:
Dr/Pc	D&B	8605	MA_Big Beat 1	4/4	4	115	●		Break Kit
Dr/Pc	D&B	8606	MB_Big Beat 1	4/4	4	115	●		:
Dr/Pc	D&B	8607	MC_Big Beat 1	4/4	4	115	●		:
Dr/Pc	D&B	8608	FA_Big Beat 1	4/4	1	115	●		:
Dr/Pc	D&B	8609	FB_Big Beat 1	4/4	1	115	●		:
Dr/Pc	D&B	8610	FC_Big Beat 1	4/4	1	115	●		:

Main Category	Sub Category	ARP No.	ARP Name	Time Signature	Length	Original Tempo	Accent	Random SFX	Sound Type
Dr/Pc	D&B	8611	BA_Big Beat 1	4/4	1	115	●		:
Dr/Pc	D&B	8612	MA1_Big Beat 2	4/4	4	145	●		:
Dr/Pc	D&B	8613	MB1_Big Beat 2	4/4	8	145	●		:
Dr/Pc	D&B	8614	MC1_Big Beat 2	4/4	4	145	●		:
Dr/Pc	D&B	8615	FA1_Big Beat 2	4/4	1	145	●		:
Dr/Pc	D&B	8616	FB1_Big Beat 2	4/4	1	145	●		:
Dr/Pc	D&B	8617	FC1_Big Beat 2	4/4	1	145	●		:
Dr/Pc	D&B	8618	BA2_Big Beat 2	4/4	2	145	●		:
Dr/Pc	D&B	8619	MA2_Big Beat 2	4/4	4	145	●		Trance Kit
Dr/Pc	D&B	8620	MB2_Big Beat 2	4/4	8	145	●		:
Dr/Pc	D&B	8621	MC2_Big Beat 2	4/4	4	145	●		:
Dr/Pc	D&B	8622	FA2_Big Beat 2	4/4	1	145	●		:
Dr/Pc	D&B	8623	FB2_Big Beat 2	4/4	1	145	●		:
Dr/Pc	D&B	8624	FC2_Big Beat 2	4/4	1	145	●		:
Dr/Pc	D&B	8625	BA2_Big Beat 2	4/4	2	145	●		:
Dr/Pc	D&B	8626	MA_Big Beat 3	4/4	2	120	●		Big Kit
Dr/Pc	D&B	8627	MB_Big Beat 3	4/4	1	120	●		:
Dr/Pc	D&B	8628	MA_Big Beat 4	4/4	1	138	●		:
Dr/Pc	D&B	8629	MA_Big Beat 5	4/4	1	128	●		:
Dr/Pc	D&B	8630	MA_Big Beat 6	4/4	4	120	●		Rock Stereo Kit 2
Dr/Pc	D&B	8631	MA_Big Beat 7	4/4	4	136	●		Big Kit
Dr/Pc	D&B	8632	MA_Big Beat 8	4/4	1	135	●		:
Dr/Pc	D&B	8633	MA_Big Beat 9	4/4	1	132	●		:
Dr/Pc	D&B	8634	MA_Big Beat 10	4/4	2	124	●		:
Dr/Pc	D&B	8635	MA_Big Beat 11	4/4	1	120	●		:
Dr/Pc	D&B	8636	MA_Break Trance	4/4	1	130	●		Tekno Kit
Dr/Pc	D&B	8637	MA1_Breakbeats 1	4/4	4	115	●		Break Kit
Dr/Pc	D&B	8638	MB1_Breakbeats 1	4/4	4	115	●		:
Dr/Pc	D&B	8639	MC1_Breakbeats 1	4/4	2	115	●		:
Dr/Pc	D&B	8640	FA1_Breakbeats 1	4/4	1	115	●		:
Dr/Pc	D&B	8641	FB1_Breakbeats 1	4/4	1	115	●		:
Dr/Pc	D&B	8642	FC1_Breakbeats 1	4/4	1	115	●		:
Dr/Pc	D&B	8643	BA1_Breakbeats 1	4/4	1	115	●		:
Dr/Pc	D&B	8644	MA2_8Z Breakt1	4/4	4	115	●		8Z Jarrin
Dr/Pc	D&B	8645	MB2_8Z Breakt1	4/4	4	115	●		:
Dr/Pc	D&B	8646	MC2_8Z Breakt1	4/4	2	115	●		:
Dr/Pc	D&B	8647	FA2_8Z Breakt1	4/4	1	115	●		:
Dr/Pc	D&B	8648	FB2_8Z Breakt1	4/4	1	115	●		:
Dr/Pc	D&B	8649	FC2_8Z Breakt1	4/4	1	115	●		:
Dr/Pc	D&B	8650	BA2_8Z Breakt1	4/4	1	115	●		:
Dr/Pc	D&B	8651	MA1_Breakbeats 2	4/4	4	88	●		Drum'n'Bass Kit
Dr/Pc	D&B	8652	MB1_Breakbeats 2	4/4	4	88	●		:
Dr/Pc	D&B	8653	MC1_Breakbeats 2	4/4	4	88	●		:
Dr/Pc	D&B	8654	FA1_Breakbeats 2	4/4	1	88	●		:
Dr/Pc	D&B	8655	FB1_Breakbeats 2	4/4	1	88	●		:
Dr/Pc	D&B	8656	FC1_Breakbeats 2	4/4	1	88	●		:
Dr/Pc	D&B	8657	BA1_Breakbeats 2	4/4	1	88	●		:
Dr/Pc	D&B	8658	MA2_Breakbeats 2	4/4	4	88	●		Big Kit
Dr/Pc	D&B	8659	MB2_Breakbeats 2	4/4	4	88	●		:
Dr/Pc	D&B	8660	MC2_Breakbeats 2	4/4	4	88	●		:
Dr/Pc	D&B	8661	FA2_Breakbeats 2	4/4	1	88	●		:
Dr/Pc	D&B	8662	FB2_Breakbeats 2	4/4	1	88	●		:
Dr/Pc	D&B	8663	FC2_Breakbeats 2	4/4	1	88	●		:
Dr/Pc	D&B	8664	BA2_Breakbeats 2	4/4	1	88	●		:
Dr/Pc	D&B	8665	MA_Lo Beat 1	4/4	2	140	●		Break Kit
Dr/Pc	D&B	8666	MA_Lo Beat 2	4/4	2	130	●		:
Dr/Pc	D&B	8667	MA_Lo Beat 3	4/4	1	122	●		:
Dr/Pc	D&B	8668	MA_Lo Beat 4	4/4	1	115	●		:
Dr/Pc	D&B	8669	MA_Lo Beat 5	4/4	4	180	●		:
Dr/Pc	D&B	8670	MA_Lo Beat 6	4/4	1	87	●		:
Dr/Pc	D&B	8671	MA_Abtract	4/4	2	86	●		Hip Hop Kit 2
Dr/Pc	D&B	8672	MA_Drum'n'Bass1	4/4	1	170	●		Jungle Kit
Dr/Pc	D&B	8673	MA_Drum'n'Bass2	4/4	2	165	●		:
Dr/Pc	D&B	8674	MA_Drum'n'Bass3	4/4	2	154	●		Drum'n'Bass Kit
Dr/Pc	D&B	8675	MB_Drum'n'Bass3	4/4	2	154	●		:
Dr/Pc	D&B	8676	MC_Drum'n'Bass3	4/4	2	154	●		:
Dr/Pc	D&B	8677	FA_Drum'n'B						

Arpeggio Type List

Main Category	Sub Category	ARP No.	ARP Name	Time Signature	Length	Original Tempo	Accent	Random SFX	Sound Type
Dr/Pc	Chill	8698	FB_Ambient 2	4 / 4	8	111	●		:
Dr/Pc	Chill	8699	FC_Ambient 2	4 / 4	1	111	●		:
Dr/Pc	Chill	8700	BA_Ambient 2	4 / 4	2	111	●		:
Dr/Pc	Chill	8701	MA1_Ambient 3	4 / 4	4	88	●		Hard Kit
Dr/Pc	Chill	8702	MB1_Ambient 3	4 / 4	4	88	●		:
Dr/Pc	Chill	8703	MC1_Ambient 3	4 / 4	4	88	●		:
Dr/Pc	Chill	8704	FA1_Ambient 3	4 / 4	1	88	●		:
Dr/Pc	Chill	8705	FB1_Ambient 3	4 / 4	1	88	●		:
Dr/Pc	Chill	8706	FC1_Ambient 3	4 / 4	1	88	●		:
Dr/Pc	Chill	8707	BA1_Ambient 3	4 / 4	1	88	●		:
Dr/Pc	Chill	8708	MA3_Ambient 3	4 / 4	4	88	●		Pop Latin Kit
Dr/Pc	Chill	8709	MB3_Ambient 3	4 / 4	4	88	●		:
Dr/Pc	Chill	8710	MC3_Ambient 3	4 / 4	4	88	●		:
Dr/Pc	Chill	8711	FA3_Ambient 3	4 / 4	1	88	●		:
Dr/Pc	Chill	8712	FB3_Ambient 3	4 / 4	1	88	●		:
Dr/Pc	Chill	8713	FC3_Ambient 3	4 / 4	1	88	●		:
Dr/Pc	Chill	8714	BA3_Ambient 3	4 / 4	1	88	●		:
Dr/Pc	Chill	8715	MA1_Chill Out	4 / 4	2	79	●		Dry Standard Kit
Dr/Pc	Chill	8716	MB1_Chill Out	4 / 4	2	79	●		:
Dr/Pc	Chill	8717	MC1_Chill Out	4 / 4	4	79	●		:
Dr/Pc	Chill	8718	MD1_Chill Out	4 / 4	2	79	●		:
Dr/Pc	Chill	8719	IA1_Chill Out	4 / 4	1	79	●		:
Dr/Pc	Chill	8720	FA1_Chill Out	4 / 4	1	79	●		:
Dr/Pc	Chill	8721	FB1_Chill Out	4 / 4	1	79	●		:
Dr/Pc	Chill	8722	FC1_Chill Out	4 / 4	4	79	●		:
Dr/Pc	Chill	8723	MA2_Chill Out	4 / 4	2	79	●		Break Kit
Dr/Pc	Chill	8724	MB2_Chill Out	4 / 4	2	79	●		:
Dr/Pc	Chill	8725	MC2_Chill Out	4 / 4	4	79	●		:
Dr/Pc	Chill	8726	MD2_Chill Out	4 / 4	2	79	●		:
Dr/Pc	Chill	8727	IA2_Chill Out	4 / 4	4	79	●		:
Dr/Pc	Chill	8728	FA2_Chill Out	4 / 4	1	79	●		:
Dr/Pc	Chill	8729	FB2_Chill Out	4 / 4	1	79	●		:
Dr/Pc	Chill	8730	FC2_Chill Out	4 / 4	4	79	●		:
Dr/Pc	Chill	8731	MA_ChillKit1 /1	4 / 4	4	85	●		Chill Out Kit
Dr/Pc	Chill	8732	MA_ChillKit1 /2	4 / 4	4	85	●		:
Dr/Pc	Chill	8733	MA_ChillKit1 /3	4 / 4	4	85	●		:
Dr/Pc	Chill	8734	MA_ChillKit1 /4	4 / 4	4	85	●		:
Dr/Pc	Chill	8735	MA_ChillKit1 /5	4 / 4	4	85	●		:
Dr/Pc	Chill	8736	MA_ChillKit2 /1	4 / 4	4	85	●		:
Dr/Pc	Chill	8737	MA_ChillKit2 /2	4 / 4	4	85	●		:
Dr/Pc	Chill	8738	MA_ChillKit2 /3	4 / 4	4	85	●		:
Dr/Pc	Chill	8739	MA_ChillKit2 /4	4 / 4	4	85	●		:
Dr/Pc	Chill	8740	MA_ChillOutBreak1	4 / 4	4	85	●		:
Dr/Pc	Chill	8741	MA_ChillOutBreak2	4 / 4	4	85	●		:
Dr/Pc	Chill	8742	MA_ChillOutBreak3	4 / 4	4	85	●		:
Dr/Pc	Chill	8743	MA_ChillOutBreak4	4 / 4	4	85	●		:
Dr/Pc	Chill	8744	MA_8Z ChillBrk1	4 / 4	4	85	●		8Z Chilly Breakz
Dr/Pc	Chill	8745	MA_8Z ChillBrk2	4 / 4	4	85	●		:
Dr/Pc	Chill	8746	MA_8Z ChillBrk3	4 / 4	4	85	●		:
Dr/Pc	Chill	8747	MA_8Z ChillBrk4	4 / 4	4	85	●		:
Dr/Pc	Chill	8748	MA_8Z ChillBrk5	4 / 4	4	85	●		:
Dr/Pc	Chill	8749	MA_ClassicAmb1	4 / 4	8	85	●		Chill Out Kit
Dr/Pc	Chill	8750	MA_ClassicAmb2	4 / 4	1	85	●		:
Dr/Pc	Chill	8751	MA_ChillOutSoft	4 / 4	1	85	●		:
Dr/Pc	Chill	8752	MA_ChillOutHard	4 / 4	2	85	●		:
Dr/Pc	Chill	8753	MA_Pop Breaks 1	4 / 4	2	90	●		:
Dr/Pc	Chill	8754	MA_8Z PopBreak2	4 / 4	4	90	●		8Z Glitch
Dr/Pc	Chill	8755	MA_8Z PopBreak3	4 / 4	4	90	●		:
Dr/Pc	Chill	8756	MA_8Z GatedBt1	4 / 4	4	85	●		8Z Gated Beatz
Dr/Pc	Chill	8757	MA_8Z GatedBt2	4 / 4	4	85	●		:
Dr/Pc	Chill	8758	MA_8Z GatedBt3	4 / 4	4	85	●		:
Dr/Pc	Chill	8759	MA_8Z GatedBt4	4 / 4	4	85	●		:
Dr/Pc	Chill	8760	MA_8Z GatedBt5	4 / 4	4	85	●		:
Dr/Pc	Chill	8761	MA_8Z HeavyHrt1	4 / 4	4	85	●		8Z Heavy Hearts
Dr/Pc	Chill	8762	MA_8Z HeavyHrt2	4 / 4	4	85	●		:
Dr/Pc	Chill	8763	MA_8Z HeavyHrt3	4 / 4	4	85	●		:
Dr/Pc	Chill	8764	MA_8Z HeavyHrt4	4 / 4	4	85	●		:
Dr/Pc	Chill	8765	MA_8Z HeavyHrt5	4 / 4	4	85	●		:
Dr/Pc	Chill	8766	MA1_Synth Pop1	4 / 4	4	90	●		House Kit 1
Dr/Pc	Chill	8767	MB1_Synth Pop1	4 / 4	4	90	●		:
Dr/Pc	Chill	8768	MC1_Synth Pop1	4 / 4	4	90	●		:
Dr/Pc	Chill	8769	MD1_Synth Pop1	4 / 4	4	90	●		:
Dr/Pc	Chill	8770	FC1_Synth Pop1	4 / 4	4	90	●		:
Dr/Pc	Chill	8771	MC2_Synth Pop1	4 / 4	2	90	●		:
Dr/Pc	Chill	8772	MD2_Synth Pop1	4 / 4	2	90	●		:
Dr/Pc	Chill	8773	FC2_Synth Pop1	4 / 4	4	90	●		:
Dr/Pc	Chill	8774	ME3_Synth Pop1	4 / 4	2	90	●		Hip Hop Kit 3
Dr/Pc	Chill	8775	ME4_Synth Pop1	4 / 4	2	90	●		House Kit 1
Dr/Pc	Chill	8776	MA_Synth Pop2	4 / 4	2	90	●		Synth Pop Kit
Dr/Pc	Chill	8777	MB_Synth Pop2	4 / 4	2	90	●		:
Dr/Pc	Chill	8778	MC_Synth Pop2	4 / 4	2	90	●		:
Dr/Pc	Chill	8779	MD_Synth Pop2	4 / 4	2	90	●		:
Dr/Pc	Chill	8780	ME_Synth Pop2	4 / 4	2	90	●		:
Dr/Pc	Chill	8781	MA_8Z Static	4 / 4	2	90	●		8Z Static
Dr/Pc	Chill	8782	MB_8Z Static	4 / 4	2	90	●		:
Dr/Pc	Chill	8783	MC_8Z Static	4 / 4	2	90	●		:
Dr/Pc	Chill	8784	MD_8Z Static	4 / 4	2	90	●		:

Main Category	Sub Category	ARP No.	ARP Name	Time Signature	Length	Original Tempo	Accent	Random SFX	Sound Type
Dr/Pc	Chill	8785	BA_8Z Static	4 / 4	1	90	●		:
Dr/Pc	Chill	8786	BB_8Z Static	4 / 4	1	90	●		:
Dr/Pc	Chill	8787	MA_Pop Chill Out	4 / 4	4	99	●		D'elo Kit
Dr/Pc	Chill	8788	MA_Fill Time	4 / 4	4	115	●		BeechwoodSnare Kit
Dr/Pc	Jazz	8789	MA_AcousticJazz	4 / 4	4	204	●		Dry Standard Kit
Dr/Pc	Jazz	8790	MB_AcousticJazz	4 / 4	4	204	●		:
Dr/Pc	Jazz	8791	MC_AcousticJazz	4 / 4	4	204	●		:
Dr/Pc	Jazz	8792	MD_AcousticJazz	4 / 4	4	204	●		:
Dr/Pc	Jazz	8793	IA_AcousticJazz	4 / 4	4	204	●		:
Dr/Pc	Jazz	8794	FA_AcousticJazz	4 / 4	1	204	●		:
Dr/Pc	Jazz	8795	FB_AcousticJazz	4 / 4	1	204	●		:
Dr/Pc	Jazz	8796	FC_AcousticJazz	4 / 4	4	204	●		:
Dr/Pc	Jazz	8797	MA1_Modern Jazz	4 / 4	16	218	●		Power Standard Kit 1
Dr/Pc	Jazz	8798	MB1_Modern Jazz	4 / 4	16	218	●		:
Dr/Pc	Jazz	8799	MC1_Modern Jazz	4 / 4	16	218	●		:
Dr/Pc	Jazz	8800	FA1_Modern Jazz	4 / 4	1	218	●		:
Dr/Pc	Jazz	8801	FB1_Modern Jazz	4 / 4	1	218	●		:
Dr/Pc	Jazz	8802	FC1_Modern Jazz	4 / 4	1	218	●		:
Dr/Pc	Jazz	8803	BA1_Modern Jazz	4 / 4	1	218	●		:
Dr/Pc	Jazz	8804	EA1_Modern Jazz	4 / 4	6	218	●		:
Dr/Pc	Jazz	8805	EB1_Modern Jazz	4 / 4	7	218	●		:
Dr/Pc	Jazz	8806	MA2_Modern Jazz	4 / 4	16	218	●		Pop Latin Kit
Dr/Pc	Jazz	8807	MB2_Modern Jazz	4 / 4	16	218	●		:
Dr/Pc	Jazz	8808	MC2_Modern Jazz	4 / 4	16	218	●		:
Dr/Pc	Jazz	8809	FA2_Modern Jazz	4 / 4	1	218	●		:
Dr/Pc	Jazz	8810	FB2_Modern Jazz	4 / 4	1	218	●		:
Dr/Pc	Jazz	8811	FC2_Modern Jazz	4 / 4	1	218	●		:
Dr/Pc	Jazz	8812	BA2_Modern Jazz	4 / 4	1	218	●		:
Dr/Pc	Jazz	8813	EA2_Modern Jazz	4 / 4	6	218	●		:
Dr/Pc	Jazz	8814	EB2_Modern Jazz	4 / 4	7	218	●		:
Dr/Pc	Jazz	8815	MA_JazzGtrClub	4 / 4	8	142	●		Brush Kit
Dr/Pc	Jazz	8816	MB_JazzGtrClub	4 / 4	8	142	●		:
Dr/Pc	Jazz	8817	MC_JazzGtrClub	4 / 4	8	142	●		:
Dr/Pc	Jazz	8818	FA_JazzGtrClub	4 / 4	1	142	●		:
Dr/Pc	Jazz	8819	FB_JazzGtrClub	4 / 4	1	142	●		:
Dr/Pc	Jazz	8820	FC_JazzGtrClub	4 / 4	1	142	●		:
Dr/Pc	Jazz	8821	BA_JazzGtrClub	4 / 4	1	142	●		:
Dr/Pc	Jazz	8822	EA_JazzGtrClub	4 / 4	6	142	●		:
Dr/Pc	Jazz	8823	MA_Bebop	4 / 4	4	152	●		Dry Standard Kit
Dr/Pc	Jazz	8824	MB_Bebop	4 / 4	4	152	●		:
Dr/Pc	Jazz	8825	MA_JazzWaltzMed	3 / 4	8	180	●		Power Standard Kit 1
Dr/Pc	Jazz	8826	MB_JazzWaltzMed	3 / 4	8	180	●		:
Dr/Pc	Jazz	8827	MC_JazzWaltzMed	3 / 4	8	180	●		:
Dr/Pc	Jazz	8828	FA_JazzWaltzMed	3 / 4	1	180	●		:
Dr/Pc	Jazz	8829	FB_JazzWaltzMed	3 / 4	1	180	●		:
Dr/Pc	Jazz	8830	FC_JazzWaltzMed	3 / 4	1	180	●		:
Dr/Pc	Jazz	8831	BA_JazzWaltzMed	3 / 4	1	180	●		:
Dr/Pc	Jazz	8832	EA_JazzWaltzMed	3 / 4	7	180	●		:
Dr/Pc	Jazz	8833	MA_R&R Shuffle	4 / 4	4	192	●		:
Dr/Pc	Jazz	8834	MB_R&R Shuffle	4 / 4	4	192	●		:
Dr/Pc	Jazz	8835	MC_R&R Shuffle	4 / 4	4	192	●		:
Dr/Pc	Jazz	8836	FA_R&R Shuffle	4 / 4	1	192	●		:
Dr/Pc	Jazz	8837	FB_R&R Shuffle	4 / 4	1	192	●		:
Dr/Pc	Jazz	8838	FC_R&R Shuffle	4 / 4	1	192	●		:
Dr/Pc	Jazz	8839	BA_R&R Shuffle	4 / 4	1	192	●		:
Dr/Pc	Jazz	8840	EA_R&R Shuffle	4 / 4	5	192	●		:
Dr/Pc	Jazz	8841	EB_R&R Shuffle	4 / 4	5	192	●		:
Dr/Pc	Jazz	8842	MA_ShuffleBlues	4 / 4	4	115	●		Power Standard Kit 2
Dr/Pc	Jazz	8843	MB_ShuffleBlues	4 / 4	4	115	●		:
Dr/Pc	Jazz	8844	MC_ShuffleBlues	4 / 4	4	115	●		:
Dr/Pc	Jazz	8845	FA_ShuffleBlues	4 / 4	1	115	●		:
Dr/Pc	Jazz	8846	FB_ShuffleBlues	4 / 4	1	115	●		:
Dr/Pc	Jazz	8847	FC_ShuffleBlues	4 / 4	1	115	●		:
Dr/Pc	Jazz	8848	BA_ShuffleBlues	4 / 4	1	115	●		:
Dr/Pc	Jazz	8849	EA_ShuffleBlues	4 / 4	5	115	●		:
Dr/Pc	Jazz	8850	EB_ShuffleBlues	4 / 4	6	115	●		:
Dr/Pc	Jazz	8851	MA_Slow Blues 1	4 / 4	2	49	●		:
Dr/Pc	Jazz	8852	MB_Slow Blues 1	4 / 4	2	49	●		:
Dr/Pc	Jazz	8853	MC_Slow Blues 1	4 / 4	2	49	●		:
Dr/Pc	Jazz	8854	FA_Slow Blues 1	4 / 4	1	49	●		:
Dr/Pc									

Arpeggio Type List

Main Category	Sub Category	ARP No.	ARP Name	Time Signature	Length	Original Tempo	Accent	Random SFX	Sound Type
Dr/Pc	Jazz	8872	FC_Piano Boogie	4/4	1	160	●		:
Dr/Pc	Jazz	8873	BA_Piano Boogie	4/4	1	160	●		:
Dr/Pc	Jazz	8874	EA_Piano Boogie	4/4	5	160	●		:
Dr/Pc	Jazz	8875	EB_Piano Boogie	4/4	5	160	●		:
Dr/Pc	Jazz	8876	*1 MA_Jazz Loop 1	4/4	4	128	●		NewMapleCustom Kit
Dr/Pc	Jazz	8877	*1 MA_Jazz Loop 2	4/4	4	103	●		Real Brushes Kit
Dr/Pc	Jazz	8878	*1 MA_Jazz Loop 3	4/4	4	88	●		Jazz Kit
Dr/Pc	Jazz	8879	*1 MA_Jazz Loop 4-1	4/4	4	78	●		:
Dr/Pc	Jazz	8880	*1 MA_Jazz Loop 4-2	4/4	4	91	●		:
Dr/Pc	Latin	8881	MA1_Salsa 1	4/4	4	177	●		Power Standard Kit 1
Dr/Pc	Latin	8882	MB1_Salsa 1	4/4	4	177	●		:
Dr/Pc	Latin	8883	MC1_Salsa 1	4/4	4	177	●		:
Dr/Pc	Latin	8884	FA1_Salsa 1	4/4	1	177	●		:
Dr/Pc	Latin	8885	FB1_Salsa 1	4/4	1	177	●		:
Dr/Pc	Latin	8886	FC1_Salsa 1	4/4	1	177	●		:
Dr/Pc	Latin	8887	BA1_Salsa 1	4/4	1	177	●		:
Dr/Pc	Latin	8888	EA1_Salsa 1	4/4	5	177	●		:
Dr/Pc	Latin	8889	EB1_Salsa 1	4/4	5	177	●		:
Dr/Pc	Latin	8890	MA2_Salsa 1	4/4	4	177	●		Pop Latin Kit
Dr/Pc	Latin	8891	MB2_Salsa 1	4/4	4	177	●		:
Dr/Pc	Latin	8892	MC2_Salsa 1	4/4	4	177	●		:
Dr/Pc	Latin	8893	FA2_Salsa 1	4/4	1	177	●		:
Dr/Pc	Latin	8894	FB2_Salsa 1	4/4	1	177	●		:
Dr/Pc	Latin	8895	FC2_Salsa 1	4/4	1	177	●		:
Dr/Pc	Latin	8896	BA2_Salsa 1	4/4	1	177	●		:
Dr/Pc	Latin	8897	EA2_Salsa 1	4/4	5	177	●		:
Dr/Pc	Latin	8898	EB2_Salsa 1	4/4	5	177	●		:
Dr/Pc	Latin	8899	MA1_Salsa 2	4/4	2	123	●		Dry Standard Kit
Dr/Pc	Latin	8900	MB1_Salsa 2	4/4	2	123	●		:
Dr/Pc	Latin	8901	MC1_Salsa 2	4/4	2	123	●		:
Dr/Pc	Latin	8902	MD1_Salsa 2	4/4	4	123	●		:
Dr/Pc	Latin	8903	IA1_Salsa 2/a	4/4	2	123	●		:
Dr/Pc	Latin	8904	IA1_Salsa 2/b	4/4	2	123	●		:
Dr/Pc	Latin	8905	FA1_Salsa 2	4/4	1	123	●		:
Dr/Pc	Latin	8906	FB1_Salsa 2	4/4	1	123	●		:
Dr/Pc	Latin	8907	FC1_Salsa 2	4/4	2	123	●		:
Dr/Pc	Latin	8908	MA2_Salsa 2	4/4	4	123	●		Pop Latin Kit
Dr/Pc	Latin	8909	MB2_Salsa 2	4/4	4	123	●		:
Dr/Pc	Latin	8910	MC2_Salsa 2	4/4	4	123	●		:
Dr/Pc	Latin	8911	MD2_Salsa 2	4/4	4	123	●		:
Dr/Pc	Latin	8912	IA2_Salsa 2	4/4	4	123	●		:
Dr/Pc	Latin	8913	FA2_Salsa 2	4/4	1	123	●		:
Dr/Pc	Latin	8914	FB2_Salsa 2	4/4	1	123	●		:
Dr/Pc	Latin	8915	FC2_Salsa 2	4/4	2	123	●		:
Dr/Pc	Latin	8916	MA1_AfroCuban	4/4	4	200	●		Power Standard Kit 1
Dr/Pc	Latin	8917	MB1_AfroCuban	4/4	4	200	●		:
Dr/Pc	Latin	8918	MC1_AfroCuban	4/4	4	200	●		:
Dr/Pc	Latin	8919	FA1_AfroCuban	4/4	1	200	●		:
Dr/Pc	Latin	8920	FB1_AfroCuban	4/4	1	200	●		:
Dr/Pc	Latin	8921	FC1_AfroCuban	4/4	1	200	●		:
Dr/Pc	Latin	8922	BA1_AfroCuban	4/4	1	200	●		:
Dr/Pc	Latin	8923	EA1_AfroCuban	4/4	6	200	●		:
Dr/Pc	Latin	8924	EB1_AfroCuban	4/4	5	200	●		:
Dr/Pc	Latin	8925	MA2_AfroCuban	4/4	4	200	●		Pop Latin Kit
Dr/Pc	Latin	8926	MB2_AfroCuban	4/4	4	200	●		:
Dr/Pc	Latin	8927	MC2_AfroCuban	4/4	4	200	●		:
Dr/Pc	Latin	8928	FA2_AfroCuban	4/4	1	200	●		:
Dr/Pc	Latin	8929	FB2_AfroCuban	4/4	1	200	●		:
Dr/Pc	Latin	8930	FC2_AfroCuban	4/4	1	200	●		:
Dr/Pc	Latin	8931	BA2_AfroCuban	4/4	1	200	●		:
Dr/Pc	Latin	8932	EA2_AfroCuban	4/4	6	200	●		:
Dr/Pc	Latin	8933	EB2_AfroCuban	4/4	5	200	●		:
Dr/Pc	Latin	8934	MA1_Montuno	4/4	2	100	●		Dry Standard Kit
Dr/Pc	Latin	8935	MB1_Montuno	4/4	2	100	●		:
Dr/Pc	Latin	8936	MC1_Montuno	4/4	2	100	●		:
Dr/Pc	Latin	8937	MD1_Montuno	4/4	2	100	●		:
Dr/Pc	Latin	8938	IA1_Montuno	4/4	2	100	●		:
Dr/Pc	Latin	8939	FA1_Montuno	4/4	1	100	●		:
Dr/Pc	Latin	8940	FB1_Montuno	4/4	1	100	●		:
Dr/Pc	Latin	8941	FC1_Montuno	4/4	2	100	●		:
Dr/Pc	Latin	8942	MA2_Montuno	4/4	4	100	●		Latin Percussion Kit
Dr/Pc	Latin	8943	MB2_Montuno	4/4	4	100	●		:
Dr/Pc	Latin	8944	MC2_Montuno	4/4	4	100	●		:
Dr/Pc	Latin	8945	MD2_Montuno	4/4	4	100	●		:
Dr/Pc	Latin	8946	IA2_Montuno	4/4	4	100	●		:
Dr/Pc	Latin	8947	FA2_Montuno	4/4	1	100	●		:
Dr/Pc	Latin	8948	FB2_Montuno	4/4	1	100	●		:
Dr/Pc	Latin	8949	FC2_Montuno	4/4	4	100	●		:
Dr/Pc	Latin	8950	MA1_Samba1	4/4	4	106	●		Brazil Kit 2
Dr/Pc	Latin	8951	MB1_Samba1	4/4	4	106	●		:
Dr/Pc	Latin	8952	MC1_Samba1	4/4	4	106	●		:
Dr/Pc	Latin	8953	MD1_Samba1	4/4	4	106	●		:
Dr/Pc	Latin	8954	FA1_Samba1	4/4	1	106	●		:
Dr/Pc	Latin	8955	FB1_Samba1	4/4	1	106	●		:
Dr/Pc	Latin	8956	FC1_Samba1	4/4	1	106	●		:
Dr/Pc	Latin	8957	FD1_Samba1	4/4	1	106	●		:
Dr/Pc	Latin	8958	MA2_Samba1	4/4	4	106	●		Real Brushes Kit

Main Category	Sub Category	ARP No.	ARP Name	Time Signature	Length	Original Tempo	Accent	Random SFX	Sound Type
Dr/Pc	Latin	8959	MB2_Samba1	4/4	4	106	●		:
Dr/Pc	Latin	8960	MC2_Samba1	4/4	4	106	●		:
Dr/Pc	Latin	8961	MD2_Samba1	4/4	4	106	●		:
Dr/Pc	Latin	8962	FA2_Samba1	4/4	1	106	●		:
Dr/Pc	Latin	8963	FB2_Samba1	4/4	1	106	●		:
Dr/Pc	Latin	8964	FC2_Samba1	4/4	1	106	●		:
Dr/Pc	Latin	8965	FD2_Samba1	4/4	1	106	●		:
Dr/Pc	Latin	8966	MA1_Samba2	4/4	4	118	●		Brazil Kit 2
Dr/Pc	Latin	8967	MB1_Samba2	4/4	4	118	●		:
Dr/Pc	Latin	8968	MC1_Samba2	4/4	4	118	●		:
Dr/Pc	Latin	8969	MD1_Samba2	4/4	4	118	●		:
Dr/Pc	Latin	8970	FA1_Samba2	4/4	1	118	●		:
Dr/Pc	Latin	8971	FB1_Samba2	4/4	1	118	●		:
Dr/Pc	Latin	8972	FC1_Samba2	4/4	1	118	●		:
Dr/Pc	Latin	8973	FD1_Samba2	4/4	1	118	●		:
Dr/Pc	Latin	8974	MA2_Samba2	4/4	4	118	●		Real Brushes Kit
Dr/Pc	Latin	8975	MB2_Samba2	4/4	4	118	●		:
Dr/Pc	Latin	8976	MC2_Samba2	4/4	4	118	●		:
Dr/Pc	Latin	8977	MD2_Samba2	4/4	4	118	●		:
Dr/Pc	Latin	8978	FA2_Samba2	4/4	1	118	●		:
Dr/Pc	Latin	8979	FB2_Samba2	4/4	1	118	●		:
Dr/Pc	Latin	8980	FC2_Samba2	4/4	1	118	●		:
Dr/Pc	Latin	8981	FD2_Samba2	4/4	1	118	●		:
Dr/Pc	Latin	8982	MA1_Brazil Samba	4/4	4	96	●		Power Standard Kit 1
Dr/Pc	Latin	8983	MB1_Brazil Samba	4/4	4	96	●		:
Dr/Pc	Latin	8984	MC1_Brazil Samba	4/4	4	96	●		:
Dr/Pc	Latin	8985	FA1_Brazil Samba	4/4	1	96	●		:
Dr/Pc	Latin	8986	FB1_Brazil Samba	4/4	1	96	●		:
Dr/Pc	Latin	8987	FC1_Brazil Samba	4/4	1	96	●		:
Dr/Pc	Latin	8988	BA1_Brazil Samba	4/4	1	96	●		:
Dr/Pc	Latin	8989	EA1_Brazil Samba	4/4	4	96	●		:
Dr/Pc	Latin	8990	EB1_Brazil Samba	4/4	4	96	●		:
Dr/Pc	Latin	8991	MA2_Brazil Samba	4/4	4	96	●		Pop Latin Kit
Dr/Pc	Latin	8992	MB2_Brazil Samba	4/4	4	96	●		:
Dr/Pc	Latin	8993	MC2_Brazil Samba	4/4	4	96	●		:
Dr/Pc	Latin	8994	FA2_Brazil Samba	4/4	1	96	●		:
Dr/Pc	Latin	8995	FB2_Brazil Samba	4/4	1	96	●		:
Dr/Pc	Latin	8996	FC2_Brazil Samba	4/4	1	96	●		:
Dr/Pc	Latin	8997	BA2_Brazil Samba	4/4	1	96	●		:
Dr/Pc	Latin	8998	EA2_Brazil Samba	4/4	4	96	●		:
Dr/Pc	Latin	8999	EB2_Brazil Samba	4/4	4	96	●		:
Dr/Pc	Latin	9000	MA_Samba	4/4	4	120	●		Dry Standard Kit
Dr/Pc	Latin	9001	MB_Samba	4/4	4	120	●		:
Dr/Pc	Latin	9002	MC_Samba	4/4	4	120	●		:
Dr/Pc	Latin	9003	MD_Samba	4/4	4	120	●		:
Dr/Pc	Latin	9004	IA_Samba	4/4	2	120	●		:
Dr/Pc	Latin	9005	FA_Samba	4/4	1	120	●		:
Dr/Pc	Latin	9006	FB_Samba	4/4	1	120	●		:
Dr/Pc	Latin	9007	FC_Samba	4/4	2	120	●		:
Dr/Pc	Latin	9008	MA_Bomba	4/4	4	99	●		Pop Latin Kit
Dr/Pc	Latin	9009	MB_Bomba	4/4	4	99	●		:
Dr/Pc	Latin	9010	MC_Bomba	4/4	4	99	●		:
Dr/Pc	Latin	9011	FA_Bomba	4/4	1	99	●		:
Dr/Pc	Latin	9012	FB_Bomba	4/4	1	99	●		:
Dr/Pc	Latin	9013	FC_Bomba	4/4	1	99	●		:
Dr/Pc	Latin	9014	BA_Bomba	4/4	1	99	●		:
Dr/Pc	Latin	9015	EA_Bomba	4/4	3	99	●		:
Dr/Pc	Latin	9016	EB_Bomba	4/4	3	99	●		:
Dr/Pc	Latin	9017	MA1_Bossa Fast	4/4	4	180	●		Brazil Kit 1
Dr/Pc	Latin	9018	MB1_Bossa Fast	4/4	4	180	●		:
Dr/Pc	Latin	9019	MC1_Bossa Fast	4/4	4	180	●		:
Dr/Pc	Latin	9020	MD1_Bossa Fast	4/4	4	180	●		:
Dr/Pc	Latin	9021	FA1_Bossa Fast	4/4	1	180	●		:
Dr/Pc	Latin	9022	FB1_Bossa Fast	4/4	1	180	●		:
Dr/Pc	Latin	9023	FC1_Bossa Fast	4/4	1	180	●		:
Dr/Pc	Latin	9024	FD1_Bossa Fast	4/4	1	180	●		:
Dr/Pc	Latin	9025	MA2_Bossa Fast	4/4	4	180	●		Real Brushes Kit
Dr/Pc	Latin	9026	MB2_Bossa Fast	4/4	4	180	●		:
Dr/Pc	Latin	9027	MC2_Bossa Fast	4/4	4	180	●		:
Dr/Pc	Latin	9028	MD2_Bossa Fast	4/4	4	180	●		:
Dr/Pc	Latin	9029	FA2_Bossa Fast	4/4	1	180	●		:
Dr/Pc	Latin	9030	FB2_Bossa Fast	4/4	1	180	●		:
Dr/Pc	Latin	9031	FC2_Bossa Fast	4/4	1	180	●		:
Dr/Pc	Latin	9032	FD2_Bossa Fast	4/4	1	180	●		:
Dr/Pc	Latin	9033	MA1_Bossa Slow	4/4					

Arpeggio Type List

Main Category	Sub Category	ARP No.	ARP Name	Time Signature	Length	Original Tempo	Accent	Random SFX	Sound Type
Dr/Pc	Latin	9046	FB2_Bossa Slow	4/4	1	90	●		:
Dr/Pc	Latin	9047	FC2_Bossa Slow	4/4	1	90	●		:
Dr/Pc	Latin	9048	FD2_Bossa Slow	4/4	1	90	●		:
Dr/Pc	Latin	9049	MA1_Bossa	4/4	4	124	●		Brush Kit
Dr/Pc	Latin	9050	MB1_Bossa	4/4	4	124	●		:
Dr/Pc	Latin	9051	MC1_Bossa	4/4	4	124	●		:
Dr/Pc	Latin	9052	FA1_Bossa	4/4	1	124	●		:
Dr/Pc	Latin	9053	FB1_Bossa	4/4	1	124	●		:
Dr/Pc	Latin	9054	FC1_Bossa	4/4	1	124	●		:
Dr/Pc	Latin	9055	BA1_Bossa	4/4	1	124	●		:
Dr/Pc	Latin	9056	EA1_Bossa	4/4	4	123	●		:
Dr/Pc	Latin	9057	EB1_Bossa	4/4	4	123	●		:
Dr/Pc	Latin	9058	MA2_Bossa	4/4	4	124	●		:
Dr/Pc	Latin	9059	MB2_Bossa	4/4	4	124	●		:
Dr/Pc	Latin	9060	MC2_Bossa	4/4	4	124	●		:
Dr/Pc	Latin	9061	FA2_Bossa	4/4	1	124	●		:
Dr/Pc	Latin	9062	FB2_Bossa	4/4	1	124	●		:
Dr/Pc	Latin	9063	FC2_Bossa	4/4	1	124	●		:
Dr/Pc	Latin	9064	BA2_Bossa	4/4	1	124	●		:
Dr/Pc	Latin	9065	EA2_Bossa	4/4	4	123	●		:
Dr/Pc	Latin	9066	EB2_Bossa	4/4	4	123	●		:
Dr/Pc	Latin	9067	MA_Merengue	4/4	4	130	●		Pop Latin Kit
Dr/Pc	Latin	9068	MB_Merengue	4/4	4	130	●		:
Dr/Pc	Latin	9069	MC_Merengue	4/4	4	130	●		:
Dr/Pc	Latin	9070	FA_Merengue	4/4	1	130	●		:
Dr/Pc	Latin	9071	FB_Merengue	4/4	1	130	●		:
Dr/Pc	Latin	9072	FC_Merengue	4/4	1	130	●		:
Dr/Pc	Latin	9073	BA_Merengue	4/4	1	130	●		:
Dr/Pc	Latin	9074	EA_Merengue	4/4	3	130	●		:
Dr/Pc	Latin	9075	EB_Merengue	4/4	3	130	●		:
Dr/Pc	Latin	9076	MA_Guaguanco	4/4	4	120	●		:
Dr/Pc	Latin	9077	MB_Guaguanco	4/4	4	120	●		:
Dr/Pc	Latin	9078	MC_Guaguanco	4/4	4	120	●		:
Dr/Pc	Latin	9079	FA_Guaguanco	4/4	1	120	●		:
Dr/Pc	Latin	9080	FB_Guaguanco	4/4	1	120	●		:
Dr/Pc	Latin	9081	FC_Guaguanco	4/4	1	120	●		:
Dr/Pc	Latin	9082	BA_Guaguanco	4/4	1	120	●		:
Dr/Pc	Latin	9083	EA_Guaguanco	4/4	3	120	●		:
Dr/Pc	Latin	9084	EB_Guaguanco	4/4	3	120	●		:
Dr/Pc	Latin	9085	MA_Latin	4/4	4	120	●		Latin Percussion Kit
Dr/Pc	Latin	9086	MB_Latin	4/4	4	120	●		:
Dr/Pc	Latin	9087	MC_Latin	4/4	4	120	●		:
Dr/Pc	Latin	9088	MD_Latin	4/4	4	120	●		:
Dr/Pc	Latin	9089	ME_Latin	4/4	4	120	●		:
Dr/Pc	Latin	9090	MA_Latin Rock	4/4	2	120	●		Dry Standard Kit
Dr/Pc	Latin	9091	MB_Latin Rock	4/4	2	120	●		:
Dr/Pc	Latin	9092	MC_Latin Rock	4/4	2	120	●		:
Dr/Pc	Latin	9093	MD_Latin Rock	4/4	4	120	●		:
Dr/Pc	Latin	9094	IA_Latin Rock	4/4	2	120	●		:
Dr/Pc	Latin	9095	FA_Latin Rock	4/4	1	120	●		:
Dr/Pc	Latin	9096	FB_Latin Rock	4/4	1	120	●		:
Dr/Pc	Latin	9097	FC_Latin Rock	4/4	1	120	●		:
Dr/Pc	Latin	9098	MA1_Disco Latin	4/4	4	100	●		:
Dr/Pc	Latin	9099	MB1_Disco Latin	4/4	4	100	●		:
Dr/Pc	Latin	9100	MC1_Disco Latin	4/4	4	100	●		:
Dr/Pc	Latin	9101	FA1_Disco Latin	4/4	1	100	●		:
Dr/Pc	Latin	9102	FB1_Disco Latin	4/4	1	100	●		:
Dr/Pc	Latin	9103	FC1_Disco Latin	4/4	1	100	●		:
Dr/Pc	Latin	9104	BA1_Disco Latin	4/4	1	100	●		:
Dr/Pc	Latin	9105	MA2_Disco Latin	4/4	4	100	●		Latin Percussion Kit
Dr/Pc	Latin	9106	MB2_Disco Latin	4/4	4	100	●		:
Dr/Pc	Latin	9107	MC2_Disco Latin	4/4	4	100	●		:
Dr/Pc	Latin	9108	FA2_Disco Latin	4/4	1	100	●		:
Dr/Pc	Latin	9109	FB2_Disco Latin	4/4	1	100	●		:
Dr/Pc	Latin	9110	FC2_Disco Latin	4/4	1	100	●		:
Dr/Pc	Latin	9111	BA2_Disco Latin	4/4	1	100	●		:
Dr/Pc	Latin	9112	MA_Latin House	4/4	4	138	●		House Kit 1
Dr/Pc	Latin	9113	FB_Latin House	4/4	4	138	●		:
Dr/Pc	Latin	9114	FC_Latin House	4/4	4	138	●		:
Dr/Pc	Latin	9115	MA_Cajon Latin 1	4/4	2	152	●		Bodhran&Cajon Kit
Dr/Pc	Latin	9116	MA_Cajon Latin 2	4/4	8	152	●		:
Dr/Pc	Latin	9117	MA_Cajon Latin 3	4/4	4	152	●		:
Dr/Pc	Latin	9118	MA_Cajon Latin 4	4/4	4	152	●		:
Dr/Pc	Latin	9119	MA_Cajon Latin 5	4/4	2	152	●		:
Dr/Pc	Latin	9120	MA_Cajon Latin 6	4/4	2	152	●		:
Dr/Pc	Latin	9121	MA_Cajon Latin 7	4/4	2	152	●		:
Dr/Pc	Latin	9122	MA_Cajon Latin 8	4/4	2	152	●		:
Dr/Pc	Latin	9123	*1 MA_Latin Loop 1	4/4	4	136	●		Pop Latin Kit
Dr/Pc	Latin	9124	*1 MA_Latin Loop 2	4/4	4	128	●		:
Dr/Pc	World	9125	MA_ReggaeShuffle	4/4	4	90	●		Power Standard Kit 1
Dr/Pc	World	9126	MB_ReggaeShuffle	4/4	4	90	●		:
Dr/Pc	World	9127	MC_ReggaeShuffle	4/4	4	90	●		:
Dr/Pc	World	9128	FA_ReggaeShuffle	4/4	1	90	●		:
Dr/Pc	World	9129	FB_ReggaeShuffle	4/4	1	90	●		:
Dr/Pc	World	9130	FC_ReggaeShuffle	4/4	1	90	●		:
Dr/Pc	World	9131	BA_ReggaeShuffle	4/4	1	90	●		:
Dr/Pc	World	9132	EA_ReggaeShuffle	4/4	3	90	●		:

Main Category	Sub Category	ARP No.	ARP Name	Time Signature	Length	Original Tempo	Accent	Random SFX	Sound Type
Dr/Pc	World	9133	EB_ReggaeShuffle	4/4	4	90	●		:
Dr/Pc	World	9134	MA_Jumbo Reggae	4/4	4	100	●		Trance Kit
Dr/Pc	World	9135	MB_Jumbo Reggae	4/4	4	100	●		:
Dr/Pc	World	9136	MC_Jumbo Reggae	4/4	4	100	●		:
Dr/Pc	World	9137	FA_Jumbo Reggae	4/4	1	100	●		:
Dr/Pc	World	9138	FB_Jumbo Reggae	4/4	1	100	●		:
Dr/Pc	World	9139	FC_Jumbo Reggae	4/4	1	100	●		:
Dr/Pc	World	9140	BA_Jumbo Reggae	4/4	1	100	●		:
Dr/Pc	World	9141	EA_Jumbo Reggae	4/4	3	100	●		:
Dr/Pc	World	9142	EB_Jumbo Reggae	4/4	3	100	●		:
Dr/Pc	World	9143	MA1_Reggae 1	4/4	4	102	●		Dry Standard Kit
Dr/Pc	World	9144	MB1_Reggae 1	4/4	4	102	●		:
Dr/Pc	World	9145	MC1_Reggae 1	4/4	4	80	●		:
Dr/Pc	World	9146	MD1_Reggae 1	4/4	4	90	●		:
Dr/Pc	World	9147	IA1_Reggae 1	4/4	4	102	●		:
Dr/Pc	World	9148	FA1_Reggae 1	4/4	1	96	●		:
Dr/Pc	World	9149	FB1_Reggae 1	4/4	1	102	●		:
Dr/Pc	World	9150	FC1_Reggae 1	4/4	4	96	●		:
Dr/Pc	World	9151	MA2_Reggae 1	4/4	4	102	●		Percussion Kit
Dr/Pc	World	9152	MB2_Reggae 1	4/4	4	102	●		:
Dr/Pc	World	9153	MC2_Reggae 1	4/4	4	80	●		:
Dr/Pc	World	9154	MD2_Reggae 1	4/4	4	90	●		:
Dr/Pc	World	9155	IA2_Reggae 1	4/4	4	102	●		:
Dr/Pc	World	9156	FC2_Reggae 1	4/4	4	96	●		:
Dr/Pc	World	9157	MA_Reggae 2	4/4	2	92	●		Dry Standard Kit
Dr/Pc	World	9158	MB_Reggae 2	4/4	2	92	●		:
Dr/Pc	World	9159	MC_Reggae 2	4/4	2	92	●		:
Dr/Pc	World	9160	MD_Reggae 2	4/4	2	92	●		:
Dr/Pc	World	9161	IA_Reggae 2/a	4/4	1	92	●		:
Dr/Pc	World	9162	IA_Reggae 2/b	4/4	1	92	●		:
Dr/Pc	World	9163	FA_Reggae 2	4/4	1	92	●		:
Dr/Pc	World	9164	FB_Reggae 2	4/4	1	92	●		:
Dr/Pc	World	9165	FC_Reggae 2	4/4	1	92	●		:
Dr/Pc	World	9166	MA1_RumbaFlamenc	4/4	4	106	●		Power Standard Kit 1
Dr/Pc	World	9167	MB1_RumbaFlamenc	4/4	4	106	●		:
Dr/Pc	World	9168	MC1_RumbaFlamenc	4/4	4	106	●		:
Dr/Pc	World	9169	FA1_RumbaFlamenc	4/4	1	106	●		:
Dr/Pc	World	9170	FB1_RumbaFlamenc	4/4	1	106	●		:
Dr/Pc	World	9171	FC1_RumbaFlamenc	4/4	1	106	●		:
Dr/Pc	World	9172	BA1_RumbaFlamenc	4/4	1	106	●		:
Dr/Pc	World	9173	EA1_RumbaFlamenc	4/4	3	106	●		:
Dr/Pc	World	9174	EB1_RumbaFlamenc	4/4	3	106	●		:
Dr/Pc	World	9175	MA2_RumbaFlamenc	4/4	4	106	●		Pop Latin Kit
Dr/Pc	World	9176	MB2_RumbaFlamenc	4/4	4	106	●		:
Dr/Pc	World	9177	MC2_RumbaFlamenc	4/4	4	106	●		:
Dr/Pc	World	9178	FA2_RumbaFlamenc	4/4	1	106	●		:
Dr/Pc	World	9179	FB2_RumbaFlamenc	4/4	1	106	●		:
Dr/Pc	World	9180	FC2_RumbaFlamenc	4/4	1	106	●		:
Dr/Pc	World	9181	BA2_RumbaFlamenc	4/4	1	106	●		:
Dr/Pc	World	9182	EA2_RumbaFlamenc	4/4	3	106	●		:
Dr/Pc	World	9183	EB2_RumbaFlamenc	4/4	3	106	●		:
Dr/Pc	World	9184	MA_Spanish Pop	4/4	2	120	●		Hyper Standard Kit
Dr/Pc	World	9185	MB_Spanish Pop	4/4	2	120	●		:
Dr/Pc	World	9186	MC_Spanish Pop	4/4	2	120	●		:
Dr/Pc	World	9187	MD_Spanish Pop	4/4	2	120	●		:
Dr/Pc	World	9188	MA_ModBluegrass	4/4	4	121	●		Power Standard Kit 2
Dr/Pc	World	9189	MB_ModBluegrass	4/4	4	121	●		:
Dr/Pc	World	9190	MC_ModBluegrass	4/4	4	121	●		:
Dr/Pc	World	9191	FA_ModBluegrass	4/4	1	121	●		:
Dr/Pc	World	9192	FB_ModBluegrass	4/4	1	121	●		:
Dr/Pc	World	9193	FC_ModBluegrass	4/4	1	121	●		:
Dr/Pc	World	9194	BA_ModBluegrass	4/4	1	121	●		:
Dr/Pc	World	9195	EA_ModBluegrass	4/4	6	121	●		:
Dr/Pc	World	9196	IA_Spanish Pop/a	4/4	1	120	●		Hyper Standard Kit
Dr/Pc	World	9197	IA_Spanish Pop/b	4/4	1	120	●		:
Dr/Pc	World	9198	FA_Spanish Pop	4/4	1	120	●		:
Dr/Pc	World	9199	FB_Spanish Pop	4/4	1	120	●		:
Dr/Pc	World	9200	FC_Spanish Pop	4/4	1	120	●		:
Dr/Pc	World	9201	MA_Irish Hymn	3/4	4	70	●		Power Standard Kit 2
Dr/Pc	World	9202	MB_Irish Hymn	3/4	4	70	●		:
Dr/Pc	World	9203	MC_Irish Hymn	3/4	4	70	●		:
Dr/Pc	World	9204	FA_Irish Hymn	3/4	1	70	●		:
Dr/Pc	World	9205	FB_Irish Hymn	3/4	1	70	●		:
Dr/Pc	World	9206	FC_Irish Hymn	3/4	1	70	●		:
Dr/Pc	World	9207	BA_Irish Hymn	3/4	1	70			

Main Category	Sub Category	ARP No.	ARP Name	Time Signature	Length	Original Tempo	Accent	Random SFX	Sound Type
Dr/Pc	World	9220	MC2_Turkish Pop	4/4	4	101	●		:
Dr/Pc	World	9221	MD2_Turkish Pop	4/4	4	101	●		:
Dr/Pc	World	9222	FA2_Turkish Pop	4/4	1	101	●		:
Dr/Pc	World	9223	FB2_Turkish Pop	4/4	1	101	●		:
Dr/Pc	World	9224	FC2_Turkish Pop	4/4	1	101	●		:
Dr/Pc	World	9225	FD2_Turkish Pop	4/4	1	101	●		:
Dr/Pc	World	9226	MA1_TurkishDance	4/4	4	130	●		Arabic Mixed Kit 1
Dr/Pc	World	9227	MB1_TurkishDance	4/4	4	130	●		:
Dr/Pc	World	9228	MC1_TurkishDance	4/4	4	130	●		:
Dr/Pc	World	9229	MD1_TurkishDance	4/4	4	130	●		:
Dr/Pc	World	9230	FA1_TurkishDance	4/4	1	130	●		:
Dr/Pc	World	9231	FB1_TurkishDance	4/4	1	130	●		:
Dr/Pc	World	9232	FC1_TurkishDance	4/4	1	130	●		:
Dr/Pc	World	9233	FD1_TurkishDance	4/4	1	130	●		:
Dr/Pc	World	9234	MA2_TurkishDance	4/4	4	130	●		Hip Hop Kit 1
Dr/Pc	World	9235	MB2_TurkishDance	4/4	4	130	●		:
Dr/Pc	World	9236	MC2_TurkishDance	4/4	4	130	●		:
Dr/Pc	World	9237	MD2_TurkishDance	4/4	4	130	●		:
Dr/Pc	World	9238	FA2_TurkishDance	4/4	1	130	●		:
Dr/Pc	World	9239	FB2_TurkishDance	4/4	1	130	●		:
Dr/Pc	World	9240	FC2_TurkishDance	4/4	1	130	●		:
Dr/Pc	World	9241	FD2_TurkishDance	4/4	1	130	●		:
Dr/Pc	World	9242	MA1_Turkish	4/4	2	105	●		Arabic Mixed Kit 1
Dr/Pc	World	9243	MB1_Turkish	4/4	2	105	●		:
Dr/Pc	World	9244	MC1_Turkish	9/8	2	125	●		:
Dr/Pc	World	9245	MD1_Turkish	9/8	2	125	●		:
Dr/Pc	World	9246	ME1_Turkish	4/4	2	105	●		:
Dr/Pc	World	9247	MF1_Turkish	4/4	2	105	●		:
Dr/Pc	World	9248	IA1_Turkish/a	4/4	1	86	●		:
Dr/Pc	World	9249	IA1_Turkish/b	4/4	1	86	●		:
Dr/Pc	World	9250	FA1_Turkish	4/4	1	120	●		:
Dr/Pc	World	9251	MA2_Turkish	4/4	2	105	●		:
Dr/Pc	World	9252	MB2_Turkish	4/4	2	105	●		:
Dr/Pc	World	9253	MC2_Turkish	9/8	2	125	●		:
Dr/Pc	World	9254	MD2_Turkish	9/8	2	125	●		:
Dr/Pc	World	9255	ME2_Turkish	4/4	2	105	●		:
Dr/Pc	World	9256	MF2_Turkish	4/4	2	105	●		:
Dr/Pc	World	9257	IA_Turkish/a	4/4	1	86	●		:
Dr/Pc	World	9258	IA_Turkish/b	4/4	1	86	●		:
Dr/Pc	World	9259	FA2_Turkish	4/4	1	120	●		:
Dr/Pc	World	9260	MA1_TurkishEuro1	4/4	4	112	●		Analog T9 Kit
Dr/Pc	World	9261	MB1_TurkishEuro1	4/4	4	112	●		:
Dr/Pc	World	9262	MC1_TurkishEuro1	4/4	4	112	●		:
Dr/Pc	World	9263	FA1_TurkishEuro1	4/4	1	112	●		:
Dr/Pc	World	9264	FB1_TurkishEuro1	4/4	1	112	●		:
Dr/Pc	World	9265	FC1_TurkishEuro1	4/4	1	112	●		:
Dr/Pc	World	9266	BA1_TurkishEuro1	4/4	1	112	●		:
Dr/Pc	World	9267	EA1_TurkishEuro1	4/4	3	112	●		:
Dr/Pc	World	9268	MA2_TurkishEuro1	4/4	4	112	●		Turkish Kit
Dr/Pc	World	9269	MB2_TurkishEuro1	4/4	4	112	●		:
Dr/Pc	World	9270	MC2_TurkishEuro1	4/4	4	112	●		:
Dr/Pc	World	9271	FA2_TurkishEuro1	4/4	1	112	●		:
Dr/Pc	World	9272	FB2_TurkishEuro1	4/4	1	112	●		:
Dr/Pc	World	9273	FC2_TurkishEuro1	4/4	1	112	●		:
Dr/Pc	World	9274	BA2_TurkishEuro1	4/4	1	112	●		:
Dr/Pc	World	9275	EA2_TurkishEuro1	4/4	3	112	●		:
Dr/Pc	World	9276	MA1_TurkishEuro2	4/4	4	120	●		Nu Hip Hop Kit 1
Dr/Pc	World	9277	MB1_TurkishEuro2	4/4	4	120	●		:
Dr/Pc	World	9278	MC1_TurkishEuro2	4/4	4	120	●		:
Dr/Pc	World	9279	FA1_TurkishEuro2	4/4	1	120	●		:
Dr/Pc	World	9280	FB1_TurkishEuro2	4/4	1	120	●		:
Dr/Pc	World	9281	FC1_TurkishEuro2	4/4	1	120	●		:
Dr/Pc	World	9282	BA1_TurkishEuro2	4/4	1	120	●		:
Dr/Pc	World	9283	EA1_TurkishEuro2	4/4	3	120	●		:
Dr/Pc	World	9284	MA2_TurkishEuro2	4/4	4	120	●		Turkish Kit
Dr/Pc	World	9285	MB2_TurkishEuro2	4/4	4	120	●		:
Dr/Pc	World	9286	MC2_TurkishEuro2	4/4	4	120	●		:
Dr/Pc	World	9287	FA2_TurkishEuro2	4/4	1	120	●		:
Dr/Pc	World	9288	FB2_TurkishEuro2	4/4	1	120	●		:
Dr/Pc	World	9289	FC2_TurkishEuro2	4/4	1	120	●		:
Dr/Pc	World	9290	BA2_TurkishEuro2	4/4	1	120	●		:
Dr/Pc	World	9291	EA2_TurkishEuro2	4/4	3	120	●		:
Dr/Pc	World	9292	MA1_Chaabi Hawzi	4/4	2	100	●		New Khaligi Kit 2
Dr/Pc	World	9293	MB1_Chaabi Hawzi	4/4	2	100	●		:
Dr/Pc	World	9294	MC1_Chaabi Hawzi	4/4	2	100	●		:
Dr/Pc	World	9295	MD1_Chaabi Hawzi	4/4	2	100	●		:
Dr/Pc	World	9296	FA1_Chaabi Hawzi	4/4	1	100	●		:
Dr/Pc	World	9297	FB1_Chaabi Hawzi	4/4	1	100	●		:
Dr/Pc	World	9298	FC1_Chaabi Hawzi	4/4	1	100	●		:
Dr/Pc	World	9299	FD1_Chaabi Hawzi	4/4	1	100	●		:
Dr/Pc	World	9300	MA2_Chaabi Hawzi	4/4	2	100	●		Arabic Mixed Kit 2
Dr/Pc	World	9301	MB2_Chaabi Hawzi	4/4	2	100	●		:
Dr/Pc	World	9302	MC2_Chaabi Hawzi	4/4	2	100	●		:
Dr/Pc	World	9303	MD2_Chaabi Hawzi	4/4	2	100	●		:
Dr/Pc	World	9304	FA2_Chaabi Hawzi	4/4	1	100	●		:
Dr/Pc	World	9305	FB2_Chaabi Hawzi	4/4	1	100	●		:
Dr/Pc	World	9306	FC2_Chaabi Hawzi	4/4	1	100	●		:

Main Category	Sub Category	ARP No.	ARP Name	Time Signature	Length	Original Tempo	Accent	Random SFX	Sound Type
Dr/Pc	World	9307	FD2_Chaabi Hawzi	4/4	1	100	●		:
Dr/Pc	World	9308	MA1_Chaoui Zendali	4/4	2	100	●		New Maghrebi Kit
Dr/Pc	World	9309	MB1_Chaoui Zendali	4/4	2	100	●		:
Dr/Pc	World	9310	MC1_Chaoui Zendali	4/4	2	100	●		:
Dr/Pc	World	9311	MD1_Chaoui Zendali	4/4	2	100	●		:
Dr/Pc	World	9312	FB1_Chaoui Zendali	4/4	1	100	●		:
Dr/Pc	World	9313	FD1_Chaoui Zendali	4/4	1	100	●		:
Dr/Pc	World	9314	MA2_Chaoui Zendali	4/4	2	100	●		Real Drums Kit
Dr/Pc	World	9315	MB2_Chaoui Zendali	4/4	2	100	●		:
Dr/Pc	World	9316	MC2_Chaoui Zendali	4/4	2	100	●		:
Dr/Pc	World	9317	MD2_Chaoui Zendali	4/4	2	100	●		:
Dr/Pc	World	9318	FA2_Chaoui Zendali	4/4	1	100	●		:
Dr/Pc	World	9319	FB2_Chaoui Zendali	4/4	1	100	●		:
Dr/Pc	World	9320	FC2_Chaoui Zendali	4/4	1	100	●		:
Dr/Pc	World	9321	FD2_Chaoui Zendali	4/4	1	100	●		:
Dr/Pc	World	9322	MA1_Ray Alaoui	4/4	2	100	●		New Maghrebi Kit
Dr/Pc	World	9323	MB1_Ray Alaoui	4/4	2	100	●		:
Dr/Pc	World	9324	MC1_Ray Alaoui	4/4	2	100	●		:
Dr/Pc	World	9325	MD1_Ray Alaoui	4/4	2	100	●		:
Dr/Pc	World	9326	MA2_Ray Alaoui	4/4	2	100	●		Real Drums Kit
Dr/Pc	World	9327	MB2_Ray Alaoui	4/4	2	100	●		:
Dr/Pc	World	9328	MC2_Ray Alaoui	4/4	2	100	●		:
Dr/Pc	World	9329	MD2_Ray Alaoui	4/4	2	100	●		:
Dr/Pc	World	9330	FA2_Ray Alaoui	4/4	1	100	●		:
Dr/Pc	World	9331	FB2_Ray Alaoui	4/4	1	100	●		:
Dr/Pc	World	9332	FC2_Ray Alaoui	4/4	1	100	●		:
Dr/Pc	World	9333	FD2_Ray Alaoui	4/4	1	100	●		:
Dr/Pc	World	9334	MA1_Kabyle	4/4	2	130	●		New Maghrebi Kit
Dr/Pc	World	9335	MB1_Kabyle	4/4	2	130	●		:
Dr/Pc	World	9336	MC1_Kabyle	4/4	2	130	●		:
Dr/Pc	World	9337	MD1_Kabyle	4/4	2	130	●		:
Dr/Pc	World	9338	FA1_Kabyle	4/4	1	130	●		:
Dr/Pc	World	9339	FB1_Kabyle	4/4	1	130	●		:
Dr/Pc	World	9340	FC1_Kabyle	4/4	1	130	●		:
Dr/Pc	World	9341	FD1_Kabyle	4/4	1	130	●		:
Dr/Pc	World	9342	MA2_Kabyle	4/4	2	130	●		Iranian Mix Kit
Dr/Pc	World	9343	MB2_Kabyle	4/4	2	130	●		:
Dr/Pc	World	9344	MC2_Kabyle	4/4	2	130	●		:
Dr/Pc	World	9345	MD2_Kabyle	4/4	2	130	●		:
Dr/Pc	World	9346	FA2_Kabyle	4/4	1	130	●		:
Dr/Pc	World	9347	FB2_Kabyle	4/4	1	130	●		:
Dr/Pc	World	9348	FC2_Kabyle	4/4	1	130	●		:
Dr/Pc	World	9349	FD2_Kabyle	4/4	1	130	●		:
Dr/Pc	World	9350	MA1_Albah	3/4	8	132	●		New Khaligi Kit 1
Dr/Pc	World	9351	MB1_Albah	3/4	8	132	●		:
Dr/Pc	World	9352	MC1_Albah	3/4	8	132	●		:
Dr/Pc	World	9353	MD1_Albah	3/4	8	132	●		:
Dr/Pc	World	9354	FA1_Albah	3/4	1	132	●		:
Dr/Pc	World	9355	FB1_Albah	3/4	1	132	●		:
Dr/Pc	World	9356	FC1_Albah	3/4	1	132	●		:
Dr/Pc	World	9357	FD1_Albah	3/4	1	132	●		:
Dr/Pc	World	9358	MA2_Albah	3/4	8	132	●		Analog T9 Kit
Dr/Pc	World	9359	MB2_Albah	3/4	8	132	●		:
Dr/Pc	World	9360	MC2_Albah	3/4	8	132	●		:
Dr/Pc	World	9361	MD2_Albah	3/4	8	132	●		:
Dr/Pc	World	9362	FA2_Albah	3/4	1	132	●		:
Dr/Pc	World	9363	FB2_Albah	3/4	1	132	●		:
Dr/Pc	World	9364	FC2_Albah	3/4	1	132	●		:
Dr/Pc	World	9365	FD2_Albah	3/4	1	132	●		:
Dr/Pc	World	9366	MA1_Khebaiti 4/4	4/4	4	79	●		New Khaligi Kit 1
Dr/Pc	World	9367	MB1_Khebaiti 4/4	4/4	4	79	●		:
Dr/Pc	World	9368	MC1_Khebaiti 4/4	4/4	4	79	●		:
Dr/Pc	World	9369	MD1_Khebaiti 4/4	4/4	4	79	●		:
Dr/Pc	World	9370	FA1_Khebaiti 4/4	4/4	1	79	●		:
Dr/Pc	World	9371	FB1_Khebaiti 4/4	4/4	1	79	●		:
Dr/Pc	World	9372	FC1_Khebaiti 4/4	4/4	1	79	●		:
Dr/Pc	World	9373	FD1_Khebaiti 4/4	4/4	1	79	●		:
Dr/Pc	World	9374	MA2_Khebaiti 4/4	4/4	4	79	●		Analog T9 Kit
Dr/Pc	World	9375	MB2_Khebaiti 4/4	4/4	4	79	●		:
Dr/Pc	World	9376	MC2_Khebaiti 4/4	4/4	4	79	●		:
Dr/Pc	World	9377	MD2_Khebaiti 4/4	4/4	4	79	●		:
Dr/Pc	World	9378	FA2_Khebaiti 4/4						

Arpeggio Type List

Main Category	Sub Category	ARP No.	ARP Name	Time Signature	Length	Original Tempo	Accent	Random SFX	Sound Type
Dr/Pc	World	9394	FA2_Bandari UAE	4/4	1	83	●		:
Dr/Pc	World	9395	FB2_Bandari UAE	4/4	1	83	●		:
Dr/Pc	World	9396	FC2_Bandari UAE	4/4	1	83	●		:
Dr/Pc	World	9397	FD2_Bandari UAE	4/4	1	83	●		:
Dr/Pc	World	9398	MA1_Shaaby	4/4	4	104	●		New Arabic Kit 1
Dr/Pc	World	9399	MB1_Shaaby	4/4	4	104	●		:
Dr/Pc	World	9400	MC1_Shaaby	4/4	4	104	●		:
Dr/Pc	World	9401	MD1_Shaaby	4/4	4	104	●		:
Dr/Pc	World	9402	FA1_Shaaby	4/4	1	104	●		:
Dr/Pc	World	9403	FB1_Shaaby	4/4	1	104	●		:
Dr/Pc	World	9404	FC1_Shaaby	4/4	1	104	●		:
Dr/Pc	World	9405	MA2_Shaaby	4/4	4	104	●		Analog T9 Kit
Dr/Pc	World	9406	MB2_Shaaby	4/4	4	104	●		:
Dr/Pc	World	9407	MC2_Shaaby	4/4	4	104	●		:
Dr/Pc	World	9408	MD2_Shaaby	4/4	4	104	●		:
Dr/Pc	World	9409	FA2_Shaaby	4/4	1	104	●		:
Dr/Pc	World	9410	FB2_Shaaby	4/4	1	104	●		:
Dr/Pc	World	9411	FC2_Shaaby	4/4	1	104	●		:
Dr/Pc	World	9412	FD2_Shaaby	4/4	1	104	●		:
Dr/Pc	World	9413	MA1_Rengi Persian	4/4	2	131	●		New Iranian Kit 1
Dr/Pc	World	9414	MB1_Rengi Persian	4/4	4	131	●		:
Dr/Pc	World	9415	MC1_Rengi Persian	4/4	4	131	●		:
Dr/Pc	World	9416	MD1_Rengi Persian	4/4	4	131	●		:
Dr/Pc	World	9417	FA1_Rengi Persian	4/4	1	131	●		:
Dr/Pc	World	9418	FB1_Rengi Persian	4/4	1	131	●		:
Dr/Pc	World	9419	FC1_Rengi Persian	4/4	1	131	●		:
Dr/Pc	World	9420	FD1_Rengi Persian	4/4	1	131	●		:
Dr/Pc	World	9421	MA2_Rengi Persian	4/4	2	131	●		Analog T9 Kit
Dr/Pc	World	9422	MB2_Rengi Persian	4/4	4	131	●		:
Dr/Pc	World	9423	MC2_Rengi Persian	4/4	4	131	●		:
Dr/Pc	World	9424	MD2_Rengi Persian	4/4	4	131	●		:
Dr/Pc	World	9425	FA2_Rengi Persian	4/4	1	131	●		:
Dr/Pc	World	9426	FB2_Rengi Persian	4/4	1	131	●		:
Dr/Pc	World	9427	FC2_Rengi Persian	4/4	1	131	●		:
Dr/Pc	World	9428	FD2_Rengi Persian	4/4	1	131	●		:
Dr/Pc	World	9429	MA1_3/4 Persian	4/4	2	75	●		New Iranian Kit 1
Dr/Pc	World	9430	MB1_3/4 Persian	4/4	2	75	●		:
Dr/Pc	World	9431	MC1_3/4 Persian	4/4	1	75	●		:
Dr/Pc	World	9432	MD1_3/4 Persian	4/4	1	75	●		:
Dr/Pc	World	9433	FA1_3/4 Persian	4/4	1	75	●		:
Dr/Pc	World	9434	FB1_3/4 Persian	4/4	1	75	●		:
Dr/Pc	World	9435	FC1_3/4 Persian	4/4	1	75	●		:
Dr/Pc	World	9436	FD1_3/4 Persian	4/4	1	75	●		:
Dr/Pc	World	9437	MA2_3/4 Persian	4/4	2	75	●		Real Drums Kit
Dr/Pc	World	9438	MB2_3/4 Persian	4/4	2	75	●		:
Dr/Pc	World	9439	MC2_3/4 Persian	4/4	1	75	●		:
Dr/Pc	World	9440	MD2_3/4 Persian	4/4	1	75	●		:
Dr/Pc	World	9441	FA2_3/4 Persian	4/4	1	75	●		:
Dr/Pc	World	9442	FB2_3/4 Persian	4/4	1	75	●		:
Dr/Pc	World	9443	FC2_3/4 Persian	4/4	1	75	●		:
Dr/Pc	World	9444	FD2_3/4 Persian	4/4	1	75	●		:
Dr/Pc	World	9445	MA1_Azari Alma	4/4	2	131	●		New Iranian Kit 1
Dr/Pc	World	9446	MB1_Azari Alma	4/4	2	131	●		:
Dr/Pc	World	9447	MC1_Azari Alma	4/4	2	131	●		:
Dr/Pc	World	9448	MD1_Azari Alma	4/4	2	131	●		:
Dr/Pc	World	9449	FA1_Azari Alma	4/4	1	131	●		:
Dr/Pc	World	9450	FB1_Azari Alma	4/4	1	131	●		:
Dr/Pc	World	9451	FC1_Azari Alma	4/4	1	131	●		:
Dr/Pc	World	9452	FD1_Azari Alma	4/4	1	131	●		:
Dr/Pc	World	9453	MA2_Azari Alma	4/4	2	131	●		Analog T9 Kit
Dr/Pc	World	9454	MB2_Azari Alma	4/4	2	131	●		:
Dr/Pc	World	9455	MC2_Azari Alma	4/4	2	131	●		:
Dr/Pc	World	9456	MD2_Azari Alma	4/4	2	131	●		:
Dr/Pc	World	9457	FA2_Azari Alma	4/4	1	131	●		:
Dr/Pc	World	9458	FB2_Azari Alma	4/4	1	131	●		:
Dr/Pc	World	9459	FC2_Azari Alma	4/4	1	131	●		:
Dr/Pc	World	9460	FD2_Azari Alma	4/4	1	131	●		:
Dr/Pc	World	9461	MA1_Bandari 1	4/4	1	131	●		New Arabic Kit 1
Dr/Pc	World	9462	MB1_Bandari 1	4/4	1	131	●		:
Dr/Pc	World	9463	MC1_Bandari 1	4/4	4	131	●		:
Dr/Pc	World	9464	MD1_Bandari 1	4/4	4	131	●		:
Dr/Pc	World	9465	FA1_Bandari 1	4/4	1	131	●		:
Dr/Pc	World	9466	FB1_Bandari 1	4/4	1	131	●		:
Dr/Pc	World	9467	FC1_Bandari 1	4/4	1	131	●		:
Dr/Pc	World	9468	FD1_Bandari 1	4/4	1	131	●		:
Dr/Pc	World	9469	MA2_Bandari 1	4/4	1	131	●		Analog T9 Kit
Dr/Pc	World	9470	MB2_Bandari 1	4/4	1	131	●		:
Dr/Pc	World	9471	MC2_Bandari 1	4/4	4	131	●		:
Dr/Pc	World	9472	MD2_Bandari 1	4/4	4	131	●		:
Dr/Pc	World	9473	FA2_Bandari 1	4/4	1	131	●		:
Dr/Pc	World	9474	FB2_Bandari 1	4/4	1	131	●		:
Dr/Pc	World	9475	FC2_Bandari 1	4/4	1	131	●		:
Dr/Pc	World	9476	FD2_Bandari 1	4/4	1	131	●		:
Dr/Pc	World	9477	MA1_Bandari 2	4/4	2	131	●		New Iranian Kit 1
Dr/Pc	World	9478	MB1_Bandari 2	4/4	4	131	●		:
Dr/Pc	World	9479	MC1_Bandari 2	4/4	4	131	●		:
Dr/Pc	World	9480	MD1_Bandari 2	4/4	4	131	●		:

Main Category	Sub Category	ARP No.	ARP Name	Time Signature	Length	Original Tempo	Accent	Random SFX	Sound Type
Dr/Pc	World	9481	FA1_Bandari 2	4/4	1	131	●		:
Dr/Pc	World	9482	FB1_Bandari 2	4/4	1	131	●		:
Dr/Pc	World	9483	FC1_Bandari 2	4/4	1	131	●		:
Dr/Pc	World	9484	FD1_Bandari 2	4/4	1	131	●		:
Dr/Pc	World	9485	MA2_Bandari 2	4/4	2	131	●		Arabic Mixed Kit 2
Dr/Pc	World	9486	MB2_Bandari 2	4/4	4	131	●		:
Dr/Pc	World	9487	MC2_Bandari 2	4/4	4	131	●		:
Dr/Pc	World	9488	MD2_Bandari 2	4/4	4	131	●		:
Dr/Pc	World	9489	FA2_Bandari 2	4/4	1	131	●		:
Dr/Pc	World	9490	FB2_Bandari 2	4/4	1	131	●		:
Dr/Pc	World	9491	FC2_Bandari 2	4/4	1	131	●		:
Dr/Pc	World	9492	FD2_Bandari 2	4/4	1	131	●		:
Dr/Pc	World	9493	MA1_Zarb Style	4/4	1	135	●		New Iranian Kit 1
Dr/Pc	World	9494	MB1_Zarb Style	4/4	1	135	●		:
Dr/Pc	World	9495	MC1_Zarb Style	4/4	1	135	●		:
Dr/Pc	World	9496	MD1_Zarb Style	4/4	4	135	●		:
Dr/Pc	World	9497	FA1_Zarb Style	4/4	1	135	●		:
Dr/Pc	World	9498	FB1_Zarb Style	4/4	1	135	●		:
Dr/Pc	World	9499	FC1_Zarb Style	4/4	1	135	●		:
Dr/Pc	World	9500	FD1_Zarb Style	4/4	1	135	●		:
Dr/Pc	World	9501	MA2_Zarb Style	4/4	1	135	●		Arabic Mixed Kit 2
Dr/Pc	World	9502	MB2_Zarb Style	4/4	1	135	●		:
Dr/Pc	World	9503	MC2_Zarb Style	4/4	1	135	●		:
Dr/Pc	World	9504	MD2_Zarb Style	4/4	4	135	●		:
Dr/Pc	World	9505	FA2_Zarb Style	4/4	1	135	●		:
Dr/Pc	World	9506	FB2_Zarb Style	4/4	1	135	●		:
Dr/Pc	World	9507	FC2_Zarb Style	4/4	1	135	●		:
Dr/Pc	World	9508	FD2_Zarb Style	4/4	1	135	●		:
Dr/Pc	World	9509	MA1_Saeidy 1	4/4	2	120	●		Hip Hop Kit 3
Dr/Pc	World	9510	MB1_Saeidy 1	4/4	2	120	●		:
Dr/Pc	World	9511	MC1_Saeidy 1	4/4	4	120	●		:
Dr/Pc	World	9512	FA1_Saeidy 1	4/4	1	120	●		:
Dr/Pc	World	9513	FB1_Saeidy 1	4/4	1	120	●		:
Dr/Pc	World	9514	FC1_Saeidy 1	4/4	1	120	●		:
Dr/Pc	World	9515	BA1_Saeidy 1	4/4	1	120	●		:
Dr/Pc	World	9516	EA1_Saeidy 1	4/4	4	120	●		:
Dr/Pc	World	9517	MA2_Saeidy 1	4/4	2	120	●		Turkish Kit
Dr/Pc	World	9518	MB2_Saeidy 1	4/4	2	120	●		:
Dr/Pc	World	9519	MC2_Saeidy 1	4/4	4	120	●		:
Dr/Pc	World	9520	FA2_Saeidy 1	4/4	1	120	●		:
Dr/Pc	World	9521	FB2_Saeidy 1	4/4	1	120	●		:
Dr/Pc	World	9522	FC2_Saeidy 1	4/4	1	120	●		:
Dr/Pc	World	9523	BA2_Saeidy 1	4/4	1	120	●		:
Dr/Pc	World	9524	EA2_Saeidy 1	4/4	4	120	●		:
Dr/Pc	World	9525	MA1_Saeidy 2	4/4	2	100	●		New Arabic Kit 1
Dr/Pc	World	9526	MB1_Saeidy 2	4/4	2	100	●		:
Dr/Pc	World	9527	MC1_Saeidy 2	4/4	2	100	●		:
Dr/Pc	World	9528	MD1_Saeidy 2	4/4	4	100	●		:
Dr/Pc	World	9529	FA1_Saeidy 2	4/4	1	100	●		:
Dr/Pc	World	9530	FB1_Saeidy 2	4/4	1	100	●		:
Dr/Pc	World	9531	FC1_Saeidy 2	4/4	1	100	●		:
Dr/Pc	World	9532	FD1_Saeidy 2	4/4	1	100	●		:
Dr/Pc	World	9533	MA2_Saeidy 2	4/4	2	100	●		Arabic Mixed Kit 2
Dr/Pc	World	9534	MB2_Saeidy 2	4/4	2	100	●		:
Dr/Pc	World	9535	MC2_Saeidy 2	4/4	2	100	●		:
Dr/Pc	World	9536	MD2_Saeidy 2	4/4	4	100	●		:
Dr/Pc	World	9537	FA2_Saeidy 2	4/4	1	100	●		:
Dr/Pc	World	9538	FB2_Saeidy 2	4/4	1	100	●		:
Dr/Pc	World	9539	FC2_Saeidy 2	4/4	1	100	●		:
Dr/Pc	World	9540	FD2_Saeidy 2	4/4	1	100	●		:
Dr/Pc	World	9541	MA1_Baladi	4/4	2	107	●		New Arabic Kit 1
Dr/Pc	World	9542	MB1_Baladi	4/4	2	107	●		:
Dr/Pc	World	9543	MC1_Baladi	4/4	2	107	●		:
Dr/Pc	World	9544	MD1_Baladi	4/4	2	107	●		:
Dr/Pc	World	9545	FA1_Baladi	4/4	1	107	●		:
Dr/Pc	World	9546	FB1_Baladi	4/4	1	107	●		:
Dr/Pc	World	9547	FC1_Baladi	4/4	1	107	●		:
Dr/Pc	World	9548	FD1_Baladi	4/4	1	107	●		:
Dr/Pc	World	9549	MA2_Baladi	4/4	2	107	●		Arabic Mixed Kit 2
Dr/Pc	World	9550	MB2_Baladi	4/4	2	107	●		:
Dr/Pc	World	9551	MC2_Baladi	4/4	2	107	●		:
Dr/Pc	World	9552	MD2_Baladi	4/4	2	107	●		:
Dr/Pc	World	9553	FA2_Baladi	4/					

Main Category	Sub Category	ARP No.	ARP Name	Time Signature	Length	Original Tempo	Accent	Random SFX	Sound Type
Dr/Pc	World	9568	MD2_Katakoufti	4/4	2	120	●		:
Dr/Pc	World	9569	FA2_Katakoufti	4/4	1	120	●		:
Dr/Pc	World	9570	FB2_Katakoufti	4/4	1	120	●		:
Dr/Pc	World	9571	FC2_Katakoufti	4/4	1	120	●		:
Dr/Pc	World	9572	FD2_Katakoufti	4/4	1	120	●		:
Dr/Pc	World	9573	MA1_6/8 Soudasi	6/4	1	110	●		New Arabic Kit 1
Dr/Pc	World	9574	MB1_6/8 Soudasi	6/4	1	110	●		:
Dr/Pc	World	9575	MC1_6/8 Soudasi	6/4	2	110	●		:
Dr/Pc	World	9576	MD1_6/8 Soudasi	6/4	2	110	●		:
Dr/Pc	World	9577	FA1_6/8 Soudasi	6/4	1	110	●		:
Dr/Pc	World	9578	FB1_6/8 Soudasi	6/4	1	110	●		:
Dr/Pc	World	9579	FC1_6/8 Soudasi	6/4	1	110	●		:
Dr/Pc	World	9580	FD1_6/8 Soudasi	6/4	1	110	●		:
Dr/Pc	World	9581	MA2_6/8 Soudasi	6/4	1	110	●		Arabic Mixed Kit 2
Dr/Pc	World	9582	MB2_6/8 Soudasi	6/4	1	110	●		:
Dr/Pc	World	9583	MC2_6/8 Soudasi	6/4	2	110	●		:
Dr/Pc	World	9584	MD2_6/8 Soudasi	6/4	2	110	●		:
Dr/Pc	World	9585	FA2_6/8 Soudasi	6/4	1	110	●		:
Dr/Pc	World	9586	FB2_6/8 Soudasi	6/4	1	110	●		:
Dr/Pc	World	9587	FC2_6/8 Soudasi	6/4	1	110	●		:
Dr/Pc	World	9588	FD2_6/8 Soudasi	6/4	1	110	●		:
Dr/Pc	World	9589	MA1_Maghrebi Asri	4/4	2	98	●		New Maghrebi Kit
Dr/Pc	World	9590	MB1_Maghrebi Asri	4/4	2	98	●		:
Dr/Pc	World	9591	MC1_Maghrebi Asri	4/4	2	98	●		:
Dr/Pc	World	9592	MD1_Maghrebi Asri	4/4	2	98	●		:
Dr/Pc	World	9593	FA1_Maghrebi Asri	4/4	1	98	●		:
Dr/Pc	World	9594	FB1_Maghrebi Asri	4/4	1	98	●		:
Dr/Pc	World	9595	FC1_Maghrebi Asri	4/4	1	98	●		:
Dr/Pc	World	9596	FD1_Maghrebi Asri	4/4	1	98	●		:
Dr/Pc	World	9597	MA2_Maghrebi Asri	4/4	2	98	●		Power Standard Kit 1
Dr/Pc	World	9598	MB2_Maghrebi Asri	4/4	2	98	●		:
Dr/Pc	World	9599	MC2_Maghrebi Asri	4/4	2	98	●		:
Dr/Pc	World	9600	MD2_Maghrebi Asri	4/4	2	98	●		:
Dr/Pc	World	9601	FA2_Maghrebi Asri	4/4	1	98	●		:
Dr/Pc	World	9602	FB2_Maghrebi Asri	4/4	1	98	●		:
Dr/Pc	World	9603	FC2_Maghrebi Asri	4/4	1	98	●		:
Dr/Pc	World	9604	FD2_Maghrebi Asri	4/4	1	98	●		:
Dr/Pc	World	9605	MA1_Chaabi Morocco	4/4	2	120	●		New Maghrebi Kit
Dr/Pc	World	9606	MB1_Chaabi Morocco	4/4	2	120	●		:
Dr/Pc	World	9607	MC1_Chaabi Morocco	4/4	2	120	●		:
Dr/Pc	World	9608	MD1_Chaabi Morocco	4/4	2	120	●		:
Dr/Pc	World	9609	FA1_Chaabi Morocco	4/4	1	120	●		:
Dr/Pc	World	9610	FB1_Chaabi Morocco	4/4	1	120	●		:
Dr/Pc	World	9611	FC1_Chaabi Morocco	4/4	1	120	●		:
Dr/Pc	World	9612	FD1_Chaabi Morocco	4/4	1	120	●		:
Dr/Pc	World	9613	MA2_Chaabi Morocco	4/4	2	120	●		Arabic Mixed Kit 2
Dr/Pc	World	9614	MB2_Chaabi Morocco	4/4	2	120	●		:
Dr/Pc	World	9615	MC2_Chaabi Morocco	4/4	2	120	●		:
Dr/Pc	World	9616	MD2_Chaabi Morocco	4/4	2	120	●		:
Dr/Pc	World	9617	FA2_Chaabi Morocco	4/4	1	120	●		:
Dr/Pc	World	9618	FB2_Chaabi Morocco	4/4	1	120	●		:
Dr/Pc	World	9619	FC2_Chaabi Morocco	4/4	1	120	●		:
Dr/Pc	World	9620	FD2_Chaabi Morocco	4/4	1	120	●		:
Dr/Pc	World	9621	MA1_Chaabi Zayani	4/4	2	120	●		New Maghrebi Kit
Dr/Pc	World	9622	MB1_Chaabi Zayani	4/4	2	120	●		:
Dr/Pc	World	9623	MC1_Chaabi Zayani	4/4	2	120	●		:
Dr/Pc	World	9624	MD1_Chaabi Zayani	4/4	2	120	●		:
Dr/Pc	World	9625	FA1_Chaabi Zayani	4/4	1	120	●		:
Dr/Pc	World	9626	FB1_Chaabi Zayani	4/4	1	120	●		:
Dr/Pc	World	9627	FC1_Chaabi Zayani	4/4	1	120	●		:
Dr/Pc	World	9628	FD1_Chaabi Zayani	4/4	1	120	●		:
Dr/Pc	World	9629	MA2_Chaabi Zayani	4/4	2	120	●		Real Drums Kit
Dr/Pc	World	9630	MB2_Chaabi Zayani	4/4	2	120	●		:
Dr/Pc	World	9631	MC2_Chaabi Zayani	4/4	2	120	●		:
Dr/Pc	World	9632	MD2_Chaabi Zayani	4/4	2	120	●		:
Dr/Pc	World	9633	FA2_Chaabi Zayani	4/4	1	120	●		:
Dr/Pc	World	9634	FB2_Chaabi Zayani	4/4	1	120	●		:
Dr/Pc	World	9635	FC2_Chaabi Zayani	4/4	1	120	●		:
Dr/Pc	World	9636	FD2_Chaabi Zayani	4/4	1	120	●		:
Dr/Pc	World	9637	MA1_Bounawara	4/4	2	150	●		New Maghrebi Kit
Dr/Pc	World	9638	MB1_Bounawara	4/4	2	150	●		:
Dr/Pc	World	9639	MC1_Bounawara	4/4	4	150	●		:
Dr/Pc	World	9640	MD1_Bounawara	4/4	4	150	●		:
Dr/Pc	World	9641	FA1_Bounawara	4/4	1	150	●		:
Dr/Pc	World	9642	FB1_Bounawara	4/4	1	150	●		:
Dr/Pc	World	9643	FC1_Bounawara	4/4	1	150	●		:
Dr/Pc	World	9644	FD1_Bounawara	4/4	1	150	●		:
Dr/Pc	World	9645	MA2_Bounawara	4/4	2	150	●		Arabic Mixed Kit 2
Dr/Pc	World	9646	MB2_Bounawara	4/4	2	150	●		:
Dr/Pc	World	9647	MC2_Bounawara	4/4	4	150	●		:
Dr/Pc	World	9648	MD2_Bounawara	4/4	4	150	●		:
Dr/Pc	World	9649	FA2_Bounawara	4/4	1	150	●		:
Dr/Pc	World	9650	FB2_Bounawara	4/4	1	150	●		:
Dr/Pc	World	9651	FC2_Bounawara	4/4	1	150	●		:
Dr/Pc	World	9652	FD2_Bounawara	4/4	1	150	●		:
Dr/Pc	World	9653	MA1_Ghita	6/8	2	145	●		New Maghrebi Kit
Dr/Pc	World	9654	MB1_Ghita	6/8	2	145	●		:

Main Category	Sub Category	ARP No.	ARP Name	Time Signature	Length	Original Tempo	Accent	Random SFX	Sound Type
Dr/Pc	World	9655	MC1_Ghita	6/8	2	145	●		:
Dr/Pc	World	9656	MD1_Ghita	6/8	4	145	●		:
Dr/Pc	World	9657	FA1_Ghita	6/8	1	145	●		:
Dr/Pc	World	9658	FB1_Ghita	6/8	1	145	●		:
Dr/Pc	World	9659	FC1_Ghita	6/8	1	145	●		:
Dr/Pc	World	9660	FD1_Ghita	6/8	1	145	●		:
Dr/Pc	World	9661	MA2_Ghita	6/8	2	145	●		Arabic Mixed Kit 2
Dr/Pc	World	9662	MB2_Ghita	6/8	2	145	●		:
Dr/Pc	World	9663	MC2_Ghita	6/8	2	145	●		:
Dr/Pc	World	9664	MD2_Ghita	6/8	4	145	●		:
Dr/Pc	World	9665	FA2_Ghita	6/8	1	145	●		:
Dr/Pc	World	9666	FB2_Ghita	6/8	1	145	●		:
Dr/Pc	World	9667	FC2_Ghita	6/8	1	145	●		:
Dr/Pc	World	9668	FD2_Ghita	6/8	1	145	●		:
Dr/Pc	World	9669	MA_PercussionMaster	4/4	2	110	●		Perc Master Kit
Dr/Pc	World	9670	MB_PercussionMaster	4/4	2	110	●		:
Dr/Pc	World	9671	MC_PercussionMaster	4/4	2	110	●		:
Dr/Pc	World	9672	MD_PercussionMaster	4/4	2	110	●		:
Dr/Pc	World	9673	ME_PercussionMaster	4/4	4	110	●		:
Dr/Pc	World	9674	MA_8Z Djembe	4/4	2	100	●		8Z Djembe
Dr/Pc	World	9675	MB_8Z Djembe	4/4	2	100	●		:
Dr/Pc	World	9676	MC_8Z Djembe	4/4	2	100	●		:
Dr/Pc	World	9677	MD_8Z Djembe	4/4	2	100	●		:
Dr/Pc	World	9678	BA_8Z Djembe	4/4	2	100	●		:
Dr/Pc	World	9679	BB_8Z Djembe	4/4	2	100	●		:
Dr/Pc	World	9680	MA_8Z Cajon	4/4	2	110	●		8Z Cajon
Dr/Pc	World	9681	MB_8Z Cajon	4/4	2	110	●		:
Dr/Pc	World	9682	MC_8Z Cajon	4/4	2	110	●		:
Dr/Pc	World	9683	MD_8Z Cajon	4/4	2	110	●		:
Dr/Pc	World	9684	EA_8Z Cajon	4/4	3	110	●		:
Dr/Pc	World	9685	MA_Japan	4/4	4	103	●		Japan Kit
Dr/Pc	World	9686	MB_Japan	4/4	4	103	●		:
Dr/Pc	World	9687	MC_Japan	4/4	4	103	●		:
Dr/Pc	World	9688	MD_Japan	4/4	2	103	●		:
Dr/Pc	World	9689	EA_Japan	4/4	4	103	●		:
Dr/Pc	World	9690	MA_Due Time	4/4	4	115	●		BeechwoodSnare Kit
Dr/Pc	General	9691	MA_Cajon 1	4/4	2	152	●		Bothran&Cajon Kit
Dr/Pc	General	9692	MA_Cajon 2	4/4	2	152	●		:
Dr/Pc	General	9693	MA_Cajon 3	4/4	4	152	●		:
Dr/Pc	General	9694	MA_Cajon 4	4/4	4	152	●		:
Dr/Pc	General	9695	MA_Cajon 5	4/4	4	152	●		:
Dr/Pc	General	9696	MA_Cajon 6	4/4	2	152	●		:
Dr/Pc	General	9697	MA_Cajon Swing 1	4/4	2	152	●		:
Dr/Pc	General	9698	MA_Cajon Swing 2	4/4	2	152	●		:
Dr/Pc	General	9699	MA_Cajon Swing 3	4/4	8	152	●		:
Dr/Pc	General	9700	MA_6/8 Bodhran 1	4/4	2	120	●		:
Dr/Pc	General	9701	MA_6/8 Bodhran 2	4/4	4	120	●		:
Dr/Pc	General	9702	MA_6/8 Bodhran 3	4/4	8	147	●		:
Dr/Pc	General	9703	MA_6/8 Bodhran 4	4/4	8	147	●		:
Dr/Pc	General	9704	MA_6/8 Bones 1	4/4	2	120	●		Bones&Spoons Kit
Dr/Pc	General	9705	MA_6/8 Bones 2	4/4	2	120	●		:
Dr/Pc	General	9706	MA_6/8 Bones 3	4/4	2	120	●		:
Dr/Pc	General	9707	MA_6/8 Bones 4	4/4	2	120	●		:
Dr/Pc	General	9708	MA_6/8 Spoons 1	4/4	2	120	●		:
Dr/Pc	General	9709	MA_6/8 Spoons 2	4/4	2	120	●		:
Dr/Pc	General	9710	MA_6/8 Spoons 3	4/4	2	120	●		:
Dr/Pc	General	9711	MA_6/8 Spoons 4	4/4	4	147	●		:
Dr/Pc	General	9712	MA_Orchestra	4/4	4	102	●		Orchestra Kit
Dr/Pc	General	9713	MC_Orchestra	4/4	8	102	●		:
Dr/Pc	General	9714	MD_Orchestra	4/4	4	102	●		:
Dr/Pc	General	9715	FA_Orchestra	4/4	1	102	●		:
Dr/Pc	General	9716	MA_Nu Orchestra	4/4	4	120	●		Nu Orchestra Kit
Dr/Pc	General	9717	MB_Nu Orchestra	4/4	4	120	●		:
Dr/Pc	General	9718	MC_Nu Orchestra	4/4	4	120	●		:
Dr/Pc	General	9719	MD_Nu Orchestra	4/4	2	120	●		:
Dr/Pc	General	9720	ME_Nu Orchestra	4/4	1	120	●		:
Dr/Pc	General	9721	MF_Nu Orchestra	4/4	4	120	●		:
Dr/Pc	General	9722	8Beat Slice1	4/4	1	135	●		Power Standard Kit 1
Dr/Pc	General	9723	8Beat Slice2	4/4	1	135	●		:
Dr/Pc	General	9724	8Beat Slice3	4/4	1	135	●		:
Dr/Pc	General	9725	16BeatSlice1	4/4	1	135	●		:
Dr/Pc	General	9726	16BeatSlice2	4/4</					

Main Category	Sub Category	ARP No.	ARP Name	Time Signature	Length	Original Tempo	Accent	Random SFX	Sound Type
S.FX	Techno	9742	BA_Sp SFX	4/4	1	100			:
S.FX	Chill	9743	MA2_Ambient 3	4/4	4	88			SFX Kit
S.FX	Chill	9744	MB2_Ambient 3	4/4	4	88			:
S.FX	Chill	9745	MC2_Ambient 3	4/4	4	88			:
S.FX	Chill	9746	FA2_Ambient 3	4/4	1	88			:
S.FX	Chill	9747	FB2_Ambient 3	4/4	1	88			:
S.FX	Chill	9748	FC2_Ambient 3	4/4	1	88			:
S.FX	Chill	9749	BA2_Ambient 3	4/4	1	88			:
M.FX	Hip Hop	9750	IA_Hip Hop 2	4/4	1	94			Vinyl Hit
M.FX	Hip Hop	9751	FC_Hip Hop 2_N	4/4	2	94			:
M.FX	Modern R&B	9752	MA_J-R&B Pop_C	4/4	4	100			New Stab
M.FX	Modern R&B	9753	MB_J-R&B Pop_C	4/4	4	100			:
M.FX	Modern R&B	9754	MC_J-R&B Pop_C	4/4	4	100			:
M.FX	Modern R&B	9755	FA_J-R&B Pop_C	4/4	1	100			:
M.FX	Modern R&B	9756	FC_J-R&B Pop_C	4/4	1	100			:
M.FX	Modern R&B	9757	BA_J-R&B Pop_C	4/4	1	100			:
M.FX	Techno	9758	MA1_Techno 1_N	4/4	4	135			Thinking of You
M.FX	Techno	9759	MB1_Techno 1_N	4/4	8	135			:
M.FX	Techno	9760	MC1_Techno 1_N	4/4	8	135			:
M.FX	Techno	9761	FA1_Techno 1_N	4/4	1	135			:
M.FX	Techno	9762	FB1_Techno 1_N	4/4	1	135			:
M.FX	Techno	9763	BA1_Techno 1_N	4/4	4	135			:
M.FX	D&B	9764	MA_ComplxtrSQ01_N	4/4	2	140			Mega Complxtr
M.FX	D&B	9765	MA_ComplxtrSQ02_N	4/4	2	140			:
M.FX	D&B	9766	MA_ComplxtrSQ03_N	4/4	2	140			:
M.FX	D&B	9767	MA_ComplxtrSQ04_N	4/4	2	140			:
M.FX	D&B	9768	MA_ComplxtrSQ05_N	4/4	2	140			:
M.FX	D&B	9769	MA_ComplxtrSQ06_N	4/4	2	140			:
M.FX	D&B	9770	MA_ComplxtrSQ07_N	4/4	2	140			:
M.FX	D&B	9771	MA_ComplxtrSQ08_N	4/4	2	140			:
M.FX	D&B	9772	MA_ComplxtrSQ09_N	4/4	2	140			:
M.FX	D&B	9773	MA_ComplxtrSQ10_N	4/4	2	140			:
M.FX	D&B	9774	MA_ComplxtrSQ11_N	4/4	2	140			:
M.FX	D&B	9775	MA_ComplxtrSQ12_N	4/4	2	140			:
M.FX	D&B	9776	MA_ComplxtrSQ13_N	4/4	2	140			:
M.FX	D&B	9777	MA_ComplxtrSQ14_N	4/4	2	140			:
M.FX	D&B	9778	MA_ComplxtrSQ15_N	4/4	2	140			:
M.FX	D&B	9779	MA_ComplxtrSQ16_N	4/4	2	140			:
M.FX	D&B	9780	MA_ComplxtrSQ17_N	4/4	2	140			:
M.FX	D&B	9781	MA_ComplxtrSQ18_N	4/4	2	140			:
M.FX	D&B	9782	MA_ComplxtrSQ19_N	4/4	2	140			:
M.FX	D&B	9783	MA_ComplxtrSQ20_N	4/4	2	140			:
M.FX	D&B	9784	MA_ComplxtrSQ21_N	4/4	2	140			:
M.FX	D&B	9785	MA_ComplxtrSQ22_N	4/4	2	140			:
M.FX	D&B	9786	MA_ComplxtrBs01_N	4/4	2	140			:
M.FX	D&B	9787	MA_ComplxtrBs02_N	4/4	2	140			:
M.FX	D&B	9788	MA_ComplxtrBs03_N	4/4	2	140			:
M.FX	D&B	9789	MA_ComplxtrBs04_N	4/4	2	140			:
M.FX	D&B	9790	MA_ComplxtrBs05_N	4/4	2	140			:
M.FX	D&B	9791	MA_ComplxtrBs06_N	4/4	4	140			:
M.FX	D&B	9792	MA_ComplxtrBs07_N	4/4	4	140			:
M.FX	D&B	9793	MA_ComplxtrBs08_N	4/4	2	140			:
M.FX	D&B	9794	MA_ComplxtrBs09_N	4/4	2	140			:
M.FX	D&B	9795	MA_ComplxtrBs10_N	4/4	2	140			:
M.FX	Chill	9796	MA_Ambient 5	4/4	4	112			Deep Motion AF1&2
M.FX	Chill	9797	MA_Ambient 5 AF1	4/4	4	112			:
M.FX	Chill	9798	MA_Ambient 5 AF1&2	4/4	4	112			:
Ethnc	World	9799	MA_Harmonium_N	4/4	2	140			India Harmonium
Ethnc	World	9800	MB_Harmonium_N	4/4	2	140			:
Ethnc	World	9801	MC_Harmonium_N	4/4	2	140			:
Ethnc	World	9802	MD_Harmonium_N	4/4	2	140			:
Ethnc	World	9803	ME_Harmonium_N	4/4	2	140			:
Ethnc	World	9804	MA_ModBluegrass_C	4/4	4	121			Banjo
Ethnc	World	9805	MB_ModBluegrass_C	4/4	4	121			:
Ethnc	World	9806	MC_ModBluegrass_C	4/4	4	121			:
Ethnc	World	9807	FA_ModBluegrass_C	4/4	1	121			:
Ethnc	World	9808	FB_ModBluegrass_C	4/4	1	121			:
Ethnc	World	9809	FC_ModBluegrass_C	4/4	1	121			:
Ethnc	World	9810	BA_ModBluegrass_C	4/4	1	121			:
Ethnc	World	9811	EA_ModBluegrass_C	4/4	6	121			:
Ethnc	World	9812	MB1_Turkish_N	4/4	2	105			Koloun
Ethnc	World	9813	MD1_Turkish_N	9/8	2	125			:
Ethnc	World	9814	ME1_Turkish_N	4/4	2	105			:
Ethnc	World	9815	IA1_Turkish_N	4/4	2	86			:
Ethnc	World	9816	MF2_Turkish_N	4/4	2	105			Kanun
Ethnc	World	9817	MA3_Turkish_N	4/4	2	105			Bouzuki
Ethnc	World	9818	MA_Sitar_N	4/4	2	140			Sitar
Ethnc	World	9819	MB_Sitar_N	4/4	2	140			:
Ethnc	World	9820	MC_Sitar_N	4/4	2	140			:
Ethnc	World	9821	MD_Sitar_N	4/4	2	140			:
Ethnc	World	9822	ME_Sitar_N	4/4	2	140			:
Ethnc	World	9823	MA_Sitar Gliss_N	4/4	3	120			:
Ethnc	World	9824	MB_Sitar Gliss_N	4/4	3	120			:
Ethnc	World	9825	MA_Berimbau_N	4/4	4	110			Berimbau
Ethnc	World	9826	MB_Berimbau_N	4/4	2	110			:
Ethnc	World	9827	MC_Berimbau_N	4/4	4	110			:
Ethnc	World	9828	MD_Berimbau_N	4/4	4	110			:

Main Category	Sub Category	ARP No.	ARP Name	Time Signature	Length	Original Tempo	Accent	Random SFX	Sound Type
Ethnc	World	9829	ME_Berimbau_N	4/4	2	110			:
Ethnc	World	9830	MA1_Turkish_N	4/4	2	105			Ney
Ethnc	World	9831	MF1_Turkish_N	4/4	2	105			:
Ct/Hb	Comb	9832	MA_Hybrid1	4/4	1	130			Syn Comp/Lead/Pad
Ct/Hb	Comb	9833	MA_Hybrid2	4/4	1	130			:
Ct/Hb	Comb	9834	MA_Hybrid3	4/4	1	130			:
Ct/Hb	Comb	9835	MA_Hybrid4	4/4	1	130			:
Ct/Hb	Comb	9836	MA_Hybrid5	4/4	1	95			:
Ct/Hb	Comb	9837	MA_Hybrid6	4/4	1	130			:
Ct/Hb	Comb	9838	MA_Hybrid7	4/4	1	130			:
Ct/Hb	Comb	9839	MA_Hybrid8	4/4	1	90			:
Ct/Hb	Comb	9840	MA_Hybrid9	4/4	1	130			:
Ct/Hb	Comb	9841	MA_Hybrid10	4/4	1	130			:
Ct/Hb	Comb	9842	MA_Hybrid11	4/4	1	130			:
Ct/Hb	Comb	9843	MA_Hybrid12	4/4	1	90			:
Ct/Hb	Comb	9844	MA_Hybrid13	4/4	1	130			:
Ct/Hb	Comb	9845	MA_Hybrid14	4/4	1	130			:
Ct/Hb	Comb	9846	MA_Hybrid15	4/4	1	130			:
Ct/Hb	Comb	9847	MA_Hybrid16	4/4	1	106			:
Ct/Hb	Comb	9848	MA_Hybrid17	4/4	1	130			:
Ct/Hb	Comb	9849	MA_Hybrid18	4/4	1	110			:
Ct/Hb	Comb	9850	MA_Hybrid19	4/4	1	100			:
Ct/Hb	Comb	9851	MA_Hybrid20	4/4	1	116			:
Ct/Hb	Comb	9852	MA_Hybrid1CF1	4/4	1	130			:
Ct/Hb	Comb	9853	MA_Hybrid1CF2	4/4	1	130			:
Ct/Hb	Comb	9854	MA_Hybrid1CF3	4/4	1	130			:
Ct/Hb	Comb	9855	MA_Hybrid1CF3 AF1&2	4/4	1	84			:
Ct/Hb	Comb	9856	MA_Hybrid1CF4	4/4	1	130			:
Ct/Hb	Comb	9857	MA_Hybrid3 CF	4/4	1	120			:
Ct/Hb	Comb	9858	MA_Hybrid21CF	4/4	1	100			:
Ct/Hb	Comb	9859	MA_Hybrid21CF AF1	4/4	1	119			:
Ct/Hb	Comb	9860	MA_Hybrid21CF AF2	4/4	1	119			:
Ct/Hb	Comb	9861	MA_Hybrid21CF AF1&2	4/4	1	119			:
Ct/Hb	Comb	9862	MA_Hybrid22CF	4/4	1	138			:
Ct/Hb	Comb	9863	MA_Hybrid23CF	4/4	1	130			:
Ct/Hb	Comb	9864	MA_Hybrid24CF	4/4	1	130			:
Ct/Hb	Comb	9865	MA_Hybrid24CF AF2	4/4	1	84			:
Ct/Hb	Comb	9866	MA_Hybrid25CF	4/4	1	96			:
Ct/Hb	Comb	9867	MA_Parade	4/4	2	120			:
Ct/Hb	Comb	9868	MA_SynPop Comb1	4/4	4	90			:
Ct/Hb	Comb	9869	MA_SynPop Comb2	4/4	4	90			:
Ct/Hb	Comb	9870	MA_Trancy1_N	4/4	1	140			:
Ct/Hb	Comb	9871	MA_Trancy2	4/4	4	140			:
Ct/Hb	Comb	9872	MA_Trancy3	4/4	16	140			:
Ct/Hb	Zone	9873	MA_2Z_Comb S01	4/4	2	90			:
Ct/Hb	Zone	9874	MA_2Z_Comb S02	4/4	1	70			:
Ct/Hb	Zone	9875	MA_2Z_Comb S03	4/4	1	90			:
Ct/Hb	Zone	9876	MA_2Z_Comb S04	4/4	1	130			:
Ct/Hb	Zone	9877	MA_2Z_Comb S05	4/4	2	130			:
Ct/Hb	Zone	9878	MA_2Z_Comb S06	4/4	2	130			:
Ct/Hb	Zone	9879	MA_2Z_Comb S07	4/4	1	130			:
Ct/Hb	Zone	9880	MA_2Z_Comb S08	4/4	1	70			:
Ct/Hb	Zone	9881	MA_2Z_Comb S09	4/4	2	130			:
Ct/Hb	Zone	9882	MA_2Z_Comb S010	4/4	2	70			:
Ct/Hb	Zone	9883	MA_2Z_Comb S011	4/4	1	70			:
Ct/Hb	Zone	9884	MA_2Z_Comb S012	4/4	1	70			:
Ct/Hb	Zone	9885	MA_2Z_Comb S013	4/4	2	90			:
Ct/Hb	Zone	9886	MA_4Z_HybVel1	4/4	1	96			:
Ct/Hb	Zone	9887	MA_4Z_HybVel2	4/4	1	96			:
Ct/Hb	Zone	9888	MA_4Z_HybVel3	4/4	1	96			:
Ct/Hb	Zone	9889	MA_4Z_HybVel4	4/4	1	96			:
Ct/Hb	Zone	9890	MA_4Z_HybVel5	4/4	1	96			:
Ct/Hb	Zone	9891	MA_4Z_HybVel6	4/4	1	96			:
Ct/Hb	Zone	9892	MA_4Z_HybVel7	4/4	1	96			:
Ct/Hb	Zone	9893	MA_4Z_HybVel7 AF1&2	4/4	1	123			:
Ct/Hb	Zone	9894	MA_4Z_HybVel8	4/4	1	96			:
Ct/Hb	Zone	9895	MA_4Z_HybVel9	4/4	2	120			:
Ct/Hb	Zone	9896	MA_4Z_HybVel10	4/4	2	120			:
Ct/Hb	Zone	9897	MA_4Z_HybVel11	4/4	2	120			:
Ct/Hb	Zone	9898	MA_4Z_HybVel12	4/4	2	120			:
Ct/Hb	Zone	9899	MA_4Z_HybVel13	4/4	2	120			:
Ct/Hb	Zone	9900	MA_4Z_HybVel14	4/4	2	120			:
Ct/Hb	Zone	9901	MA_4Z_HybVel15	4/4	2	120			:
Ct/Hb	Zone	9902	MA_4Z_HybVel16	4/4	2	120			:
Ct/Hb	Zone	9903	MA_4Z_4Zone1A	4/4	2	130			:
Ct/Hb	Zone	9904	MA_4Z_4Zone1B	4/4	2				

Arpeggio Type List

Main Category	Sub Category	ARP No.	ARP Name	Time Signature	Length	Original Tempo	Accent	Random SFX	Sound Type
Ct/Hb	Zone	9916	MA_4Z_4Zone3D	4/4	1	94			:
Ct/Hb	Zone	9917	MA_4Z_4Zone3E	4/4	1	94			:
Ct/Hb	Zone	9918	MA_4Z_4Zone4A	4/4	1	70			:
Ct/Hb	Zone	9919	MA_4Z_4Zone4B	4/4	1	70			:
Ct/Hb	Zone	9920	MA_4Z_4Zone4C	4/4	1	70			:
Ct/Hb	Zone	9921	MA_4Z_4Zone4D	4/4	1	70			:
Ct/Hb	Zone	9922	MA_4Z_4Zone4E	4/4	1	70			:
Ct/Hb	Zone	9923	MA_4Z_4Zone5A	4/4	1	70			:
Ct/Hb	Zone	9924	MA_4Z_4Zone5B	4/4	1	70			:
Ct/Hb	Zone	9925	MA_4Z_4Zone5C	4/4	1	70			:
Ct/Hb	Zone	9926	MA_4Z_4Zone5D	4/4	1	70			:
Ct/Hb	Zone	9927	MA_4Z_4Zone5E	4/4	1	70			:
Ct/Hb	Zone	9928	MA_4Z_HybPrc1	4/4	1	130			:
Ct/Hb	Zone	9929	MA_4Z_HybPrc2	4/4	1	130			:
Ct/Hb	Zone	9930	MA_4Z_HybPrc3	4/4	1	130			:
Ct/Hb	Zone	9931	MA_4Z_HybPrc4	4/4	1	130			:
Ct/Hb	Zone	9932	MA_4Z_HybPrc5	4/4	1	130			:
Ct/Hb	Zone	9933	MA_4Z_HybPrc6	4/4	1	130			:
Ct/Hb	Zone	9934	MA_4Z_HybPrc7	4/4	1	130			:
Ct/Hb	Zone	9935	MA_4Z_HybPrc8	4/4	1	90			:
Ct/Hb	Zone	9936	MA_4Z_HybPrc9	4/4	1	90			:
Ct/Hb	Zone	9937	MA_4Z_HybPrc10	4/4	1	90			:
Ct/Hb	Zone	9938	MA_4Z_lce 1_N	1/4	4	130			:
Ct/Hb	Zone	9939	MA_4Z_lce 2_N	1/4	8	130			:
Ct/Hb	Zone	9940	MA_4Z_lce 3	1/4	4	140			:
Ct/Hb	Zone	9941	MA_4Z_lce 4	1/4	8	130			:
Ct/Hb	Zone	9942	MA_4Z_lce 5	1/4	8	130			:
Ct/Hb	Zone	9943	MA_4Z_lce 6	1/4	8	130			:
Ct/Hb	Zone	9944	MA_4Z_lce 7	1/4	8	130			:
Ct/Hb	Zone	9945	MA_4Z_lce 8	1/4	8	130			:
Ct/Hb	Zone	9946	MA_4Z_lce 9	1/4	4	140			:
Ct/Hb	Zone	9947	MA_4Z_lce 10	1/4	4	140			:
Ct/Hb	Zone	9948	MA_4Z_RndmBeat1	4/4	8	90			:
Ct/Hb	Zone	9949	MA_4Z_RndmBeat2	4/4	8	90			:
Ct/Hb	Zone	9950	MA_4Z_RndmBeat3	4/4	2	90			:
Ct/Hb	Zone	9951	MA_4Z_RndmBeat4	4/4	2	90			:
Ct/Hb	Zone	9952	MA_4Z_RndmBeat5	4/4	2	90			:
Ct/Hb	Zone	9953	MA_4Z_RndmBeat6	4/4	8	90			:
Ct/Hb	Zone	9954	MA_4Z_RndmBeat7	4/4	8	90			:
Ct/Hb	Zone	9955	MA_4Z_Bend	4/4	1	120			:
Ct/Hb	Zone	9956	MA_8Z_8ZoneArp 1A	4/4	1	56			:
Ct/Hb	Zone	9957	MA_8Z_8ZoneArp 1B	4/4	1	56			:
Ct/Hb	Zone	9958	MA_8Z_8ZoneArp 1C	4/4	1	56			:
Ct/Hb	Zone	9959	MA_8Z_8ZoneArp 1D	4/4	1	56			:
Ct/Hb	Zone	9960	MA_8Z_8ZoneArp 1E	4/4	1	56			:
Ct/Hb	Zone	9961	MA_8Z_8ZoneArpH 1A	4/4	2	112			:
Ct/Hb	Zone	9962	MA_8Z_8ZoneArpH 1B	4/4	2	112			:
Ct/Hb	Zone	9963	MA_8Z_8ZoneArpH 1C	4/4	2	112			:
Ct/Hb	Zone	9964	MA_8Z_8ZoneArpH 1D	4/4	2	112			:
Ct/Hb	Zone	9965	MA_8Z_8ZoneArpH 1E	4/4	2	112			:
Ct/Hb	Zone	9966	MA_8Z_8ZoneArp 2A	4/4	1	112			:
Ct/Hb	Zone	9967	MA_8Z_8ZoneArp 2B	4/4	1	112			:
Ct/Hb	Zone	9968	MA_8Z_8ZoneArp 2C	4/4	1	112			:
Ct/Hb	Zone	9969	MA_8Z_8ZoneArp 2D	4/4	1	112			:
Ct/Hb	Zone	9970	MA_8Z_8ZoneArp 2E	4/4	1	112			:
Ct/Hb	Zone	9971	MA_8Z_8ZoneArp 3A	4/4	1	140			:
Ct/Hb	Zone	9972	MA_8Z_8ZoneArp 3B	4/4	1	140			:
Ct/Hb	Zone	9973	MA_8Z_8ZoneArp 3C	4/4	1	140			:
Ct/Hb	Zone	9974	MA_8Z_8ZoneArp 3D	4/4	1	140			:
Ct/Hb	Zone	9975	MA_8Z_8ZoneArp 3E	4/4	1	140			:
Ct/Hb	Z.Pad	9976	MA_PadL_Pad Seq1	4/4	2	108			:
Ct/Hb	Z.Pad	9977	MA_PadL_Pad Seq2	4/4	2	104			:
Ct/Hb	Z.Pad	9978	MA_PadL_Pad Seq3	4/4	2	104			:
Ct/Hb	Z.Pad	9979	MA_PadL_Pad Seq4	4/4	2	104			:
Ct/Hb	Z.Pad	9980	MA_PadL_Pad Seq5	4/4	1	108			:
Ct/Hb	Z.Pad	9981	MA_PadL_Pad Seq6	4/4	2	90			:
Ct/Hb	Z.Pad	9982	MA_PadL_Pad Seq7	4/4	2	90			:
Ct/Hb	Z.Pad	9983	MA_PadL_Pad Seq8	4/4	1	90			:
Ct/Hb	Z.Pad	9984	MA_PadL_Pad Seq9	4/4	1	90			:
Ct/Hb	Z.Pad	9985	MA_PadL_Pad Seq10	4/4	1	145			:
Ct/Hb	Z.Pad	9986	MA_PadL_Pad Seq11	4/4	1	130			:
Ct/Hb	Z.Pad	9987	MA_PadL_Pad Seq12	4/4	2	130			:
Ct/Hb	Z.Pad	9988	MA_PadL_Pad Seq13	4/4	1	90			:
Ct/Hb	Z.Pad	9989	MA_PadL_Pad Seq14	4/4	1	90			:
Ct/Hb	Z.Pad	9990	MA_PadH_Pad Seq1	4/4	1	70			:
Ct/Hb	Z.Pad	9991	MA_PadH_Pad Seq2	4/4	1	70			:
Ct/Hb	Z.Pad	9992	MA_PadH_Pad Seq3	4/4	1	70			:
Ct/Hb	Z.Pad	9993	MA_PadH_Pad Seq4	4/4	1	90			:
Ct/Hb	Z.Pad	9994	MA_PadH_Pad Seq5	4/4	1	124			:
Ct/Hb	Z.Pad	9995	MA_PadH_Pad Seq6	4/4	1	56			:
Ct/Hb	Z.Pad	9996	MA_PadH_Pad Seq7	4/4	2	145			:
Ct/Hb	Z.Pad	9997	MA_PadH_Pad Seq8	4/4	2	145			:
Ct/Hb	Z.Pad	9998	MA_PadH_Pad Seq9	4/4	1	145			:
Ct/Hb	Z.Pad	9999	MA_PadH_Pad Seq10	4/4	2	145			:
Ct/Hb	Z.Pad	10000	MA_PadH_Pad Seq11	4/4	2	145			:
Ct/Hb	Z.Pad	10001	MA_PadH_Pad Seq12	4/4	2	145			:
Ct/Hb	Z.Pad	10002	MA_PadH_Pad Seq13	4/4	2	145			:

Main Category	Sub Category	ARP No.	ARP Name	Time Signature	Length	Original Tempo	Accent	Random SFX	Sound Type
Ct/Hb	Z.Pad	10003	MA_PadH_Pad Seq14	4/4	1	145			:
Ct/Hb	Z.Pad	10004	MA_PadH_Pad Seq15	4/4	2	145			:
Ct/Hb	Z.Pad	10005	MA_PadH_Pad Seq16	4/4	2	145			:
Ct/Hb	Z.Pad	10006	MA_PadH_Pad Seq17	4/4	2	145			:
Ct/Hb	Z.Pad	10007	MA_PadH_Pad Seq18	4/4	1	145			:
Ct/Hb	Z.Pad	10008	MA_PadH_Pad Seq19	4/4	1	145			:
Ct/Hb	Filter	10009	Gate Cut1	4/4	4	120			(CC#10,71,74)
Ct/Hb	Filter	10010	Gate Cut2	4/4	1	120			(CC#74)
Ct/Hb	Filter	10011	Gate Cut3	4/4	8	120			(CC#71,74)
Ct/Hb	Filter	10012	CC-Dive1	4/4	4	130			:
Ct/Hb	Filter	10013	CC-Dive2	4/4	2	130			:
Ct/Hb	Filter	10014	FilterWave1	4/4	4	105			:
Ct/Hb	Filter	10015	FilterWave2	4/4	4	105			:
Ct/Hb	Filter	10016	Filter 16	4/4	1	153			(CC#74)
Ct/Hb	Filter	10017	Filter 32	4/4	1	153			:
Ct/Hb	Filter	10018	Filter 3to3	4/4	2	153			:
Ct/Hb	Filter	10019	Filter3Delay	4/4	1	153			:
Ct/Hb	Filter	10020	Filter Fill1	4/4	1	153			:
Ct/Hb	Filter	10021	Filter Fill2	4/4	1	153			:
Ct/Hb	Filter	10022	Filter Fill3	4/4	1	153			:
Ct/Hb	Filter	10023	Filter Fill4	4/4	1	153			:
Ct/Hb	Filter	10024	MC_Hip Hop 2	4/4	2	94			(CC#71,74)
Ct/Hb	Filter	10025	FB_Hip Hop 2	4/4	1	94			:
Ct/Hb	Filter	10026	IA_Trance 5_N	4/4	4	140			(CC#74)
Ct/Hb	Filter	10027	MA1_Acid Breaks	4/4	1	98			(CC#10,74)
Ct/Hb	Filter	10028	IA_Dream Dance	4/4	4	136			(CC#74)
Ct/Hb	Filter	10029	MC_Club House	4/4	2	128			(CC#71,74)
Ct/Hb	Filter	10030	FA_Club House	4/4	1	128			(CC#71)
Ct/Hb	Filter	10031	MB_Garage 2	4/4	2	127			(CC#74)
Ct/Hb	Filter	10032	MC_Garage 2	4/4	2	127			:
Ct/Hb	Filter	10033	FA_Garage 2	4/4	1	127			:
Ct/Hb	Filter	10034	MA_Chill Out	4/4	2	79			:
Ct/Hb	Filter	10035	MD_Chill Out	4/4	2	79			(CC#11,74)
Ct/Hb	Filter	10036	IA_Chill Out	4/4	4	79			(CC#74)
Ct/Hb	Filter	10037	FB_Chill Out	4/4	1	79			:
Ct/Hb	Filter	10038	MA_Ambient 3	4/4	2	75			(CC#71,74)
Ct/Hb	Filter	10039	MA_Ambient 3 AF1	4/4	2	75			:
Ct/Hb	Filter	10040	MA_Ambient 3 AF2	4/4	2	75			:
Ct/Hb	Filter	10041	MB_Ambient 3	4/4	4	75			(CC#74)
Ct/Hb	Filter	10042	MB_Ambient 3 AF1	4/4	4	75			:
Ct/Hb	Filter	10043	MB_Ambient 3 AF2	4/4	4	75			:
Ct/Hb	Filter	10044	MC_Ambient 3	4/4	2	75			(CC#71,74)
Ct/Hb	Filter	10045	MC_Ambient 3 AF1	4/4	2	75			:
Ct/Hb	Filter	10046	MC_Ambient 3 AF2	4/4	2	75			:
Ct/Hb	Filter	10047	Wobble 1	4/4	1	120			(CC#74)
Ct/Hb	Filter	10048	Wobble 2	4/4	1	120			:
Ct/Hb	Filter	10049	Wobble 3	4/4	1	120			:
Ct/Hb	Filter	10050	Wobble 4	4/4	2	120			:
Ct/Hb	Filter	10051	Wobble 5	4/4	2	120			(CC#10,11,74)
Ct/Hb	Exprs	10052	GateL1	4/4	1	134			(CC#11)
Ct/Hb	Exprs	10053	GateL2	4/4	1	134			:
Ct/Hb	Exprs	10054	GateL3	4/4	1	134			:
Ct/Hb	Exprs	10055	GateL4	4/4	1	134			:
Ct/Hb	Exprs	10056	GateL5	4/4	1	134			:
Ct/Hb	Exprs	10057	GateL6	4/4	1	134			:
Ct/Hb	Exprs	10058	GateL7	4/4	1	134			:
Ct/Hb	Exprs	10059	GateL8	4/4	1	134			:
Ct/Hb	Exprs	10060	GateL9	4/4	1	134			:
Ct/Hb	Exprs	10061	GateL10	4/4	1	134			:
Ct/Hb	Exprs	10062	GateL11	4/4	1	134			:
Ct/Hb	Exprs	10063	GateL12	4/4	1	134			:
Ct/Hb	Exprs	10064	GateL13	4/4	1	134			:
Ct/Hb	Exprs	10065	GateL14	4/4	1	134			:
Ct/Hb	Exprs	10066	GateL15	4/4	1	134			:
Ct/Hb	Exprs	10067	GateL16	4/4	1	134			:
Ct/Hb	Exprs	10068	GateL17	4/4	1	134			:
Ct/Hb	Exprs	10069	GateL18	4/4	1	134			:
Ct/Hb	Exprs	10070	GateL19	4/4	1	134			:
Ct/Hb	Exprs	10071	GateL20	4/4	1	134			:
Ct/Hb	Exprs	10072	GateM1	4/4	1	134			:
Ct/Hb	Exprs	10073	GateM2	4/4	1	134			:
Ct/Hb	Exprs	10074	GateM3	4/4	1	134			:
Ct/Hb	Exprs	10075	GateM4	4/4	1	13			

Main Category	Sub Category	ARP No.	ARP Name	Time Signature	Length	Original Tempo	Accent	Random SFX	Sound Type
C/Hb	Exprs	10090	GateM19	4/4	1	134			:
C/Hb	Exprs	10091	GateM20	4/4	1	134			:
C/Hb	Exprs	10092	GateS1	4/4	1	134			:
C/Hb	Exprs	10093	GateS2	4/4	1	134			:
C/Hb	Exprs	10094	GateS3	4/4	1	134			:
C/Hb	Exprs	10095	GateS4	4/4	1	134			:
C/Hb	Exprs	10096	GateS5	4/4	1	134			:
C/Hb	Exprs	10097	GateS6	4/4	1	134			:
C/Hb	Exprs	10098	GateS7	4/4	1	134			:
C/Hb	Exprs	10099	GateS8	4/4	1	134			:
C/Hb	Exprs	10100	GateS9	4/4	1	134			:
C/Hb	Exprs	10101	GateS10	4/4	1	134			:
C/Hb	Exprs	10102	GateS11	4/4	1	134			:
C/Hb	Exprs	10103	GateS12	4/4	1	134			:
C/Hb	Exprs	10104	GateS13	4/4	1	134			:
C/Hb	Exprs	10105	GateS14	4/4	1	134			:
C/Hb	Exprs	10106	GateS15	4/4	1	134			:
C/Hb	Exprs	10107	GateS16	4/4	1	134			:
C/Hb	Exprs	10108	GateS17	4/4	1	134			:
C/Hb	Exprs	10109	GateS18	4/4	1	134			:
C/Hb	Exprs	10110	GateS19	4/4	1	134			:
C/Hb	Exprs	10111	GateS20	4/4	1	134			:
C/Hb	Exprs	10112	LevSawDown	4/4	1	90			:
C/Hb	Exprs	10113	SlicePhrase1	4/4	1	153			:
C/Hb	Exprs	10114	SlicePhrase2	4/4	1	153			:
C/Hb	Exprs	10115	SlicePhrase3	4/4	1	153			:
C/Hb	Exprs	10116	SlicePhrase4	4/4	1	153			:
C/Hb	Exprs	10117	SlicePhrase5	4/4	4	153			:
C/Hb	Exprs	10118	SlicePhrase6	4/4	4	153			:
C/Hb	Exprs	10119	SlicePhrase7	4/4	4	153			:
C/Hb	Exprs	10120	SlicePhrase8	4/4	4	153			:
C/Hb	Exprs	10121	Slice 16	4/4	1	153			:
C/Hb	Exprs	10122	Slice 32	4/4	1	155			:
C/Hb	Exprs	10123	Slice to3	4/4	1	153			:
C/Hb	Exprs	10124	Slice 3Delay	4/4	1	153			:
C/Hb	Exprs	10125	Slice Fill1	4/4	1	153			:
C/Hb	Exprs	10126	Slice Fill2	4/4	2	153			:
C/Hb	Exprs	10127	Slice Fill3	4/4	2	153			:
C/Hb	Exprs	10128	Slice Fill4	4/4	2	153			:
C/Hb	Exprs	10129	MA_Dream Trance	4/4	1	140			:
C/Hb	Exprs	10130	MA_Dream Trance AF1	4/4	1	140			:
C/Hb	Exprs	10131	MB_Dream Trance	4/4	1	140			:
C/Hb	Exprs	10132	MB_Dream Trance AF2	4/4	1	140			:
C/Hb	Exprs	10133	Pumping&Notes S	4/4	1	120			:
C/Hb	Exprs	10134	Pumping&Notes M	4/4	1	120			:
C/Hb	Exprs	10135	Pumping&Notes L	4/4	1	120			:
C/Hb	Exprs	10136	Pumping&Notes P	4/4	1	120			(CC#10,11)
C/Hb	Exprs	10137	PumpingCtrl S	4/4	1	120			(CC#11)
C/Hb	Exprs	10138	PumpingCtrl M	4/4	1	120			:
C/Hb	Exprs	10139	PumpingCtrl L	4/4	1	120			:
C/Hb	Exprs	10140	PumpingCtrl P	4/4	1	120			(CC#10,11)
C/Hb	Pan	10141	Pan Efx4CRL	4/4	1	153			(CC#10)
C/Hb	Pan	10142	Pan Efx4LCR	4/4	1	153			:
C/Hb	Pan	10143	Pan Efx4RLC	4/4	1	153			:
C/Hb	Pan	10144	Pan Efx8+LR	4/4	1	153			:
C/Hb	Pan	10145	Pan Efx16CRL	4/4	1	153			:
C/Hb	Pan	10146	Pan Efx16RL	4/4	1	153			:
C/Hb	Pan	10147	Pan Efx16RL-C	4/4	1	153			:
C/Hb	Pan	10148	Pan 16RL-WRL	4/4	2	153			:
C/Hb	Pan	10149	MB_Hip Hop 2	4/4	2	94			:
C/Hb	Pan	10150	MB_New Gospel	4/4	2	90			(CC#10,11)
C/Hb	Pan	10151	MC_New Gospel	4/4	2	90			:
C/Hb	Pan	10152	IA_New Gospel	4/4	1	90			:
C/Hb	Pan	10153	IA_Club House	4/4	2	128			(CC#10)
C/Hb	Mod	10154	Mod Control	4/4	4	64			(CC#1)
C/Hb	Mod	10155	Mod ControlU	4/4	4	90			:
C/Hb	PBend	10156	Bend Vibrato	4/4	4	120			(PB, PB Range=12)
C/Hb	PBend	10157	BottleDwVib	4/4	4	120			:
C/Hb	PBend	10158	BottleUpVib	4/4	4	120			:
C/Hb	PBend	10159	HammerVib	4/4	4	120			:
C/Hb	PBend	10160	PullingVib1	4/4	4	120			:
C/Hb	PBend	10161	PullingVib2	4/4	4	120			:
C/Hb	PBend	10162	SlideVibrato	4/4	4	120			:
C/Hb	PBend	10163	U/D ChokrnVib	4/4	4	120			:
C/Hb	PBend	10164	Trill 4	4/4	4	120			:
C/Hb	PBend	10165	Trill 5	4/4	4	120			:
C/Hb	PBend	10166	Vibrato1	4/4	4	120			:
C/Hb	PBend	10167	Vibrato2	4/4	4	120			:
C/Hb	PBend	10168	Choking Vib	4/4	4	120			:
C/Hb	PBend	10169	Arm Down	4/4	4	120			:
C/Hb	PBend	10170	ThrobFx	4/4	4	100			(PB, PB Range=24)
C/Hb	PBend	10171	PitchEffect1	4/4	1	153			:
C/Hb	PBend	10172	PitchEffect2	4/4	1	153			:
C/Hb	PBend	10173	PitchEffect3	4/4	1	153			:
C/Hb	PBend	10174	PitchEffect4	4/4	1	153			:
C/Hb	PBend	10175	PitchEffect5	4/4	1	153			(PB, PB Range=12)
C/Hb	PBend	10176	PitchEffect6	4/4	1	153			(PB, PB Range=24)

Main Category	Sub Category	ARP No.	ARP Name	Time Signature	Length	Original Tempo	Accent	Random SFX	Sound Type
C/Hb	PBend	10177	PitchEffect7	4/4	1	153			:
C/Hb	PBend	10178	PitchEffect8	4/4	2	153			:
C/Hb	Assign	10179	AS1Env1	4/4	1	90			(CC#16)
C/Hb	Assign	10180	AS1Env2	4/4	1	90			:
C/Hb	Assign	10181	AS1Env3	4/4	1	90			:
C/Hb	Assign	10182	AS1Env4	4/4	1	90			:
C/Hb	Assign	10183	AS1Env5	4/4	1	90			:
C/Hb	Assign	10184	AS1Env6	4/4	1	90			:
C/Hb	Assign	10185	AS1Env7	4/4	1	90			:
C/Hb	Assign	10186	AS1Env8	4/4	1	90			:
C/Hb	Assign	10187	AS1Tri+1	4/4	1	150			:
C/Hb	Assign	10188	AS1Tri-1	4/4	1	90			:
C/Hb	Assign	10189	AS1TriF1	4/4	1	90			:
C/Hb	Assign	10190	AS1Tri+4	4/4	4	90			:
C/Hb	Assign	10191	AS1Tri-4	4/4	4	90			:
C/Hb	Assign	10192	AS1TriF4	4/4	4	90			:
C/Hb	Assign	10193	AS1Tri+8	4/4	8	90			:
C/Hb	Assign	10194	AS1Tri-8	4/4	8	90			:
C/Hb	Assign	10195	AS1TriF8	4/4	8	90			:
C/Hb	Assign	10196	AS1Up+1	4/4	1	90			:
C/Hb	Assign	10197	AS1Dw+1	4/4	1	90			:
C/Hb	Assign	10198	AS1SawDw	4/4	1	90			:
C/Hb	Assign	10199	AS2Env1	4/4	1	90			(CC#17)
C/Hb	Assign	10200	AS2Env2	4/4	1	90			:
C/Hb	Assign	10201	AS2Env3	4/4	1	90			:
C/Hb	Assign	10202	AS2Env4	4/4	1	90			:
C/Hb	Assign	10203	AS2Env5	4/4	1	90			:
C/Hb	Assign	10204	AS2Env6	4/4	1	90			:
C/Hb	Assign	10205	AS2Env7	4/4	1	90			:
C/Hb	Assign	10206	AS2Env8	4/4	1	90			:
C/Hb	Assign	10207	AS2Tri+1	4/4	1	90			:
C/Hb	Assign	10208	AS2Tri-1	4/4	1	90			:
C/Hb	Assign	10209	AS2TriF1	4/4	1	90			:
C/Hb	Assign	10210	AS2Tri+4	4/4	4	90			:
C/Hb	Assign	10211	AS2Tri-4	4/4	4	90			:
C/Hb	Assign	10212	AS2TriF4	4/4	4	90			:
C/Hb	Assign	10213	AS2Tri+8	4/4	8	90			:
C/Hb	Assign	10214	AS2Tri-8	4/4	8	90			:
C/Hb	Assign	10215	AS2TriF8	4/4	8	90			:
C/Hb	Assign	10216	AS2Up+1	4/4	1	90			:
C/Hb	Assign	10217	AS2Dw+1	4/4	1	90			:
C/Hb	Assign	10218	AS2SawDw	4/4	1	90			:
C/Hb	Assign	10219	MA2_Acid Breaks	4/4	1	98			:
C/Hb	Assign	10220	MB2_Acid Breaks	4/4	4	98			(CC#10,17,74)
C/Hb	General	10221	Mute 4/4	4/4	1	120			(no event)
C/Hb	General	10222	Mute 1/4	1/4	1	120			:
C/Hb	General	10223	Mute 2/4	2/4	1	120			:
C/Hb	General	10224	Mute 3/4	3/4	1	120			:
C/Hb	General	10225	Mute 5/4	5/4	1	120			:
C/Hb	General	10226	Mute 6/4	6/4	1	120			:
C/Hb	General	10227	Mute 7/4	7/4	1	120			:
C/Hb	General	10228	Mute 6/8	6/8	1	120			:
C/Hb	General	10229	Mute 1/8	1/8	1	120			:
C/Hb	General	10230	Mute 2/8	2/8	1	120			:
C/Hb	General	10231	Mute 3/8	3/8	1	120			:
C/Hb	General	10232	Mute 4/8	4/8	1	120			:
C/Hb	General	10233	Mute 5/8	5/8	1	120			:
C/Hb	General	10234	Mute 7/8	7/8	1	120			:
C/Hb	General	10235	Mute 8/8	8/8	1	120			:
C/Hb	General	10236	Mute 9/8	9/8	1	120			:
C/Hb	General	10237	Mute 10/8	10/8	1	120			:
C/Hb	General	10238	Mute 11/8	11/8	1	120			:
C/Hb	General	10239	Mute 12/8	12/8	1	120			:

Effect Type List

Category	Short Name	Effect Type Name	Side Chain/ Modulator	Type (HEX)		MONTAGE					
				MSB	LSB	REV	VAR	InsA	InsB	ADIns	Mas
	---	NO EFFECT		00	00	0	0				
	---	THRU		00	00			0	0	0	
REVERB											
	REV	HD HALL		01	03	1					
	REV	REV-X HALL		01	00	2					
	REV	R3 HALL		01	01	3					
	REV	SPX HALL		01	02	4	1	1	1	1	
	REV	HD ROOM		01	13	5					
	REV	REV-X ROOM		01	10	6					
	REV	R3 ROOM		01	11	7					
	REV	SPX ROOM		01	12	8	2	2	2	2	
	REV	HD PLATE		01	21	9					
	REV	R3 PLATE		01	20	10					
	REV	SPX STAGE		01	30	11	3	3	3	3	
	REV	SPACE SIMULATOR		01	40	12					
	REV	GATED REVERB		01	50		4	4	4	4	
	REV	REVERSE REVERB		01	58		5	5	5	5	
DELAY											
	DLY	CROSS DELAY		02	00		6	6	6	6	
	DLY	TEMPO CROSS DELAY		02	10		7	7	7	7	
	DLY	TEMPO DELAY MONO		02	20		8	8	8	8	
	DLY	TEMPO DELAY STEREO		02	28		9	9	9	9	
	DLY	CONTROL DELAY		02	30		10	10	10	10	
	DLY	DELAY LR		02	40		11	11	11	11	0
	DLY	DELAY LCR		02	50		12	12	12	12	
	DLY	ANALOG DELAY RETRO		02	60		13	13	13	13	
	DLY	ANALOG DELAY MODERN		02	68		14	14	14	14	
CHORUS											
	CHO	G CHORUS		03	00		15	15	15	15	
	CHO	2 MODULATOR		03	10		16	16	16	16	
	CHO	SPX CHORUS		03	20		17	17	17	17	
	CHO	SYMPHONIC		03	30		18	18	18	18	
	CHO	ENSEMBLE DETUNE		03	40		19	19	19	19	
FLANGER											
	FLG	VCM FLANGER		04	00		20	20	20	20	
	FLG	CLASSIC FLANGER		04	10		21	21	21	21	
	FLG	TEMPO FLANGER		04	20		22	22	22	22	
	FLG	DYNAMIC FLANGER	●	04	30		23	23	23	23	
	FLG	CONTROL FLANGER		04	08		24	24	24	24	
PHASER											
	PHA	VCM PHASER MONO		05	00		25	25	25	25	
	PHA	VCM PHASER STEREO		05	10		26	26	26	26	
	PHA	TEMPO PHASER		05	20		27	27	27	27	
	PHA	DYNAMIC PHASER	●	05	30		28	28	28	28	
	PHA	CONTROL PHASER		05	18		29	29	29	29	
TOREMOLO&ROTARY											
	T&R	AUTO PAN		06	00		30	30	30	30	
	T&R	TREMOLO		06	10		31	31	31	31	
	T&R	ROTARY SPEAKER 1		06	20		32	32	32	32	
	T&R	ROTARY SPEAKER 2		06	30		33	33	33	33	
DISTORTION											
	DST	AMP SIMULATOR 1		07	00		34	34	34	34	
	DST	AMP SIMULATOR 2		07	10		35	35	35	35	
	DST	COMP DISTORTION		07	20		36	36	36	36	
	DST	COMP DISTORTION DELAY		07	30		37	37	37	37	1
	DST	US COMBO		07	40		38	38	38	38	
	DST	JAZZ COMBO		07	41		39	39	39	39	
	DST	US HIGH GAIN		07	42		40	40	40	40	
	DST	BRITISH LEAD		07	43		41	41	41	41	
	DST	MULTI FX		07	44		42	42	42	42	
	DST	SMALL STEREO		07	45		43	43	43	43	
	DST	BRITISH COMBO		07	46		44	44	44	44	
	DST	BRITISH LEGEND		07	47		45	45	45	45	
COMPRESSOR											
	CMP	VCM COMPRESSOR 376	●	08	00		46	46	46	46	2
	CMP	CLASSIC COMPRESSOR	●	08	10		47	47	47	47	
	CMP	MULTI BAND COMP	●	08	20		48	48	48	48	3
	CMP	UNI COMP DOWN	●	08	30		49	49	49	49	4
	CMP	UNI COMP UP	●	08	38		50	50	50	50	5
	CMP	PARALLEL COMP		08	40		51	51	51	51	6
WAH											
	WAH	VCM AUTO WAH		0A	00		52	52	52	52	
	WAH	VCM TOUCH WAH		0A	10		53	53	53	53	
	WAH	VCM PEDAL WAH		0A	20		54	54	54	54	

Category	Short Name	Effect Type Name	Side Chain/ Modulator	Type (HEX)		MONTAGE					
				MSB	LSB	REV	VAR	InsA	InsB	ADIns	Mas
LO-FI											
	L-F	LO-FI		0B	00		55	55	55	55	7
	L-F	NOISY		0B	10		56	56	56	56	
	L-F	DIGITAL TURNTABLE		0B	20		57	57	57	57	
	L-F	BIT CRUSHER		0B	30		58	58	58	58	8
TECH											
	TEC	RING MODULATOR	●	0C	00		59	59	59	59	9
	TEC	DYNAMIC RING MODULATOR	●	0C	10		60	60	60	60	
	TEC	DYNAMIC FILTER	●	0C	20		61	61	61	61	10
	TEC	AUTO SYNTH		0C	30		62	62	62	62	
	TEC	SPIRALIZER P		0C	38		63	63	63	63	11
	TEC	TEMPO SPIRALIZER P		0C	39		64	64	64	64	12
	TEC	SPIRALIZER F		0C	3A		65	65	65	65	13
	TEC	TEMPO SPIRALIZER F		0C	3B		66	66	66	66	14
	TEC	ISOLATOR		0C	40		67	67	67	67	15
	TEC	SLICE		0C	50		68	68	68	68	16
	TEC	TECH MODULATION		0C	60		69	69	69	69	
	TEC	CONTROL FILTER		0C	28		70	70	70	70	
	TEC	VINYL BREAK		0C	70		71	71	71		17
	TEC	BEAT REPEAT EVEN		0C	78		72	72	72		18
	TEC	BEAT REPEAT TRIPLET		0C	79		73	73	73		19
	TEC	BEAT REPEAT EVEN+TRIPLET		0C	7A		74	74	74		20
	TEC	BEAT REPEAT FREE		0C	7B		75	75	75		21
MISC											
	MSC	VCM EQ 501		0D	00		76	76	76	71	
	MSC	PRESENCE		0D	08		77	77	77	72	22
	MSC	HARMONIC ENHANCER		0D	10		78	78	78	73	
	MSC	STEREOPHONIC OPTIMIZER		0D	18		79	79	79	74	
	MSC	TALKING MODULATOR		0D	20		80	80	80	75	
	MSC	DAMPER RESONANCE		0D	30		81	81	81	76	
	MSC	PITCH CHANGE		0D	40		82	82	82	77	
	MSC	EARLY REFLECTION		0D	50		83	83	83	78	
	MSC	VOCODER	●	0D	60		84	84	84	79	
	MSC	NOISE GATE+COMP+EQ		0D	70		85	85	85	80	

Effect Parameter List

Reverb Block

[0] OFF

When this type is selected, no parameters are available.

[1] HD HALL

[5] HD ROOM

No.	Parameter	Range	Value	Tbl No.
1	Reverb Time	0.3s – 30.0s	(0 – 69)	4
2	Room Size	0 – 4	(0 – 4)	
3	Initial Delay	0.1ms – 200.0ms	(0 – 127)	5
4	High Damp Frequency	1.0kHz – 20.0kHz	(34 – 60)	3
5	—			
6	High Ratio	0.0 – 1.0	(0 – 10)	
7	—			
8	—			
9	—			
10	—			
11	—			
12	—			
13	EQ Low Frequency	22Hz – 1.0kHz	(1 – 34)	3
14	EQ Low Gain	-12dB – 0dB – +12dB	(52 – 76)	
15	EQ High Frequency	500Hz – 18.0kHz	(28 – 59)	3
16	EQ High Gain	-12dB – 0dB – +12dB	(52 – 76)	

[9] HD PLATE

No.	Parameter	Range	Value	Tbl No.
1	Reverb Time	0.3s – 30.0s	(0 – 69)	4
2	Plate Type	0 – 2	(0 – 2)	
3	Initial Delay	0.1ms – 200.0ms	(0 – 127)	5
4	High Damp Frequency	1.0kHz – 20.0kHz	(34 – 60)	3
5	—			
6	High Ratio	0.0 – 1.0	(0 – 10)	
7	—			
8	—			
9	—			
10	—			
11	—			
12	—			
13	EQ Low Frequency	22Hz – 1.0kHz	(1 – 34)	3
14	EQ Low Gain	-12dB – 0dB – +12dB	(52 – 76)	
15	EQ High Frequency	500Hz – 18.0kHz	(28 – 59)	3
16	EQ High Gain	-12dB – 0dB – +12dB	(52 – 76)	

[2] REV-X HALL

[6] REV-X ROOM

No.	Parameter	Range	Value	Tbl No.
1	Reverb Time	0.3s – xy.zs	(0 – 69)	23/24
2	Diffusion	0 – 10	(0 – 10)	
3	Initial Delay	0.1ms – 200.0ms	(0 – 127)	5
4	HPF Cutoff Frequency	20Hz – 8.0kHz	(0 – 52)	3
5	LPF Cutoff Frequency	1.0kHz – 20.0kHz	(34 – 60)	3
6	Room Size	0 – 31	(0 – 31)	
7	High Ratio	0.1 – 1.0	(1 – 10)	
8	Low Ratio	0.1 – 1.4	(1 – 14)	
9	Decay	0 – 63	(0 – 63)	
10	—			
11	—			
12	—			
13	—			
14	—			
15	—			
16	—			

REV-X HALL: [(0 – 69)] (Table No.25)

REV-X ROOM: [(0 – 69)] (Table No.26)

For details, see the Effect Data Assign Table.

[3] R3 HALL

[4] SPX HALL

[7] R3 ROOM

[8] SPX ROOM

[10] R3 PLATE

[11] SPX STAGE

No.	Parameter	Range	Value	Tbl No.
1	Reverb Time	0.3s – 30.0s	(0 – 69)	4
2	Diffusion	0 – 10	(0 – 10)	
3	Initial Delay	0.1ms – 200.0ms	(0 – 127)	5
4	HPF Cutoff Frequency	20Hz – 8.0kHz	(0 – 52)	3
5	LPF Cutoff Frequency	1.0kHz – 20.0kHz	(34 – 60)	3
6	—			
7	—			
8	—			
9	—			
10	—			
11	Reverb Delay	0.1ms – 200.0ms	(0 – 127)	5
12	Density	0 – 4	(0 – 4)	
13	ER/Rev Balance	E63>R – E=R – E<R63	(1 – 127)	
14	Feedback High Damp	0.1 – 1.0	(1 – 10)	
15	Feedback Level	-63 – +63	(1 – 127)	
16	—			

[12] SPACE SIMULATOR

No.	Parameter	Range	Value	Tbl No.
1	Reverb Time	0.3s – 30.0s	(0 – 69)	4
2	Diffusion	0 – 10	(0 – 10)	
3	Initial Delay	0.1ms – 200.0ms	(0 – 127)	5
4	HPF Cutoff Frequency	20Hz – 8.0kHz	(0 – 52)	3
5	LPF Cutoff Frequency	1.0kHz – 20.0kHz	(34 – 60)	3
6	Width	0.5m – 30.2m	(0 – 104)	11
7	Height	0.5m – 30.2m	(0 – 104)	11
8	Depth	0.5m – 30.2m	(0 – 104)	11
9	Wall Vary	0 – 30	(0 – 30)	
10	—			
11	Reverb Delay	0.1ms – 200.0ms	(0 – 127)	5
12	Density	0 – 4	(0 – 4)	
13	ER/Rev Balance	E63>R – E=R – E<R63	(1 – 127)	
14	Feedback High Damp	0.1 – 1.0	(1 – 10)	
15	Feedback Level	-63 – +63	(1 – 127)	
16	Space Type	0 – 1	(0 – 1)	

Variation, Insertion Block

[0] THRU/OFF

When this type is selected, no parameters are available.

Category — REVERB

[1] SPX HALL

[2] SPX ROOM

[3] SPX STAGE

No.	Parameter	Range	Value	Tbl No.
1	Reverb Time	0.3s – 30.0s	(0 – 69)	4
2	Diffusion	0 – 10	(0 – 10)	
3	Initial Delay	0.1ms – 99.3ms	(0 – 63)	5
4	HPF Cutoff Frequency	20Hz – 8.0kHz	(0 – 52)	3
5	LPF Cutoff Frequency	1.0kHz – 20.0kHz	(34 – 60)	3
6	—			
7	—			
8	—			
9	—			
10	Dry/Wet Balance	D63>W – D=W – D<W63	(1 – 127)	
11	Reverb Delay	0.1ms – 99.3ms	(0 – 63)	5
12	Density	0 – 4	(0 – 4)	
13	ER/Rev Balance	E63>R – E=R – E<R63	(1 – 127)	
14	Feedback High Damp	0.1 – 1.0	(1 – 10)	
15	Feedback Level	-63 – +63	(1 – 127)	
16	—			

[4] GATED REVERB

[5] REVERSE REVERB

No.	Parameter	Range	Value	Tbl No.
1	Type	Type A, Type B	(0 – 1)	
2	Room Size	0.1 – 20.0 0.1 – 7.0 (Ins17)	(0 – 127) (0 – 44)	6
3	Diffusion	0 – 10	(0 – 10)	
4	Initial Delay	0.1ms – 200ms 0.1ms – 99.3ms (Ins17)	(0 – 127) (0 – 63)	5
5	Feedback Level	-63 – 0 – +63	(1 – 127)	
6	HPF Cutoff Frequency	20Hz – 8.0kHz	(0 – 52)	3
7	LPF Cutoff Frequency	1.0kHz – 20.0kHz	(34 – 60)	3
8	—			
9	—			
10	Dry/Wet	D63>W – D=W – D<W63	(1 – 127)	
11	Liveness	0 – 10	(0 – 10)	
12	Density	0 – 3	(0 – 3)	
13	Feedback High Damp	0.1 – 1.0	(1 – 10)	
14	—			
15	—			
16	—			

Category — DELAY

[1] CROSS DELAY

No.	Parameter	Range	Value	Tbl No.
1	Delay Time L>R	0.1ms – 1638.3ms	(1 – 16383)	
2	Delay Time R>L	0.1ms – 1638.3ms	(1 – 16383)	
3	Feedback Level	-63 – +63	(1 – 127)	
4	Input Select	L, R, L&R, L-MODE2, R-MODE2	(0 – 4)	
5	Feedback High Damp	0.1 – 1.0	(1 – 10)	
6	—			
7	—			
8	—			
9	—			
10	Dry/Wet Balance	D63>W – D=W – D<W63	(1 – 127)	
11	—			
12	—			
13	EQ Low Frequency	32Hz – 2.0kHz	(4 – 40)	3
14	EQ Low Gain	-12dB – +12dB	(52 – 76)	
15	EQ High Frequency	500Hz – 16.0kHz	(28 – 58)	3
16	EQ High Gain	-12dB – +12dB	(52 – 76)	

[2] TEMPO CROSS DELAY

No.	Parameter	Range	Value	Tbl No.
1	Delay Time L>R	32nd/3 – 4thx6	(0 – 19)	13
2	Delay Time R>L	32nd/3 – 4thx6	(0 – 19)	13
3	Feedback Level	-63 – +63	(1 – 127)	
4	Input Select	L, R, L&R, L-MODE2, R-MODE2	(0 – 4)	
5	Feedback High Damp	0.1 – 1.0	(1 – 10)	
6	Lag	-63ms – +63ms	(1 – 127)	

No.	Parameter	Range	Value	Tbl No.
7	—			
8	—			
9	—			
10	Dry/Wet Balance	D63>W – D=W – D<W63	(1 – 127)	
11	—			
12	—			

13 – 16: Same as the parameters shaded in gray in CROSS DELAY above.

[3] TEMPO DELAY MONO

No.	Parameter	Range	Value	Tbl No.
1	Delay Time	32nd/3 – 4thx6	(0 – 19)	13
2	Feedback Level	-63 – +63	(1 – 127)	
3	Feedback High Damp	0.1 – 1.0	(1 – 10)	
4	L/R Diffusion	-63ms – +63ms	(1 – 127)	
5	Lag	-63ms – +63ms	(1 – 127)	
6	—			
7	—			
8	—			
9	—			
10	Dry/Wet Balance	D63>W – D=W – D<W63	(1 – 127)	
11	—			
12	—			

13 – 16: Same as the parameters shaded in gray in CROSS DELAY above.

[4] TEMPO DELAY STEREO

No.	Parameter	Range	Value	Tbl No.
1	Delay Time	32nd/3 – 4thx6	(0 – 19)	13
2	Feedback Level	-63 – +63	(1 – 127)	
3	Feedback High Damp	0.1 – 1.0	(1 – 10)	
4	L/R Diffusion	-63ms – +63ms	(1 – 127)	
5	Lag	-63ms – +63ms	(1 – 127)	
6	—			
7	—			
8	—			
9	—			
10	Dry/Wet Balance	D63>W – D=W – D<W63	(1 – 127)	
11	—			
12	—			

13 – 16: Same as the parameters shaded in gray in CROSS DELAY on page 150.

[5] CONTROL DELAY

No.	Parameter	Range	Value	Tbl No.
1	Delay Time	0.1ms – 1486.0ms	(1 – 14860)	
2	Delay transition rate	1 – 48	(1 – 48)	
3	Feedback Level	-63 – +63	(1 – 127)	
4	Feedback High Damp	0.1 – 1.0	(1 – 10)	
5	—			
6 – 9	Same as the parameters shaded in gray in CROSS DELAY on page 150.			
10	Dry/Wet Balance	D63>W – D=W – D<W63	(1 – 127)	
11	Control Type	Normal, Scratch	(0 – 1)	
12	—			
13	—			
14	—			
15	—			
16	—			

[6] DELAY L, R

No.	Parameter	Range	Value	Tbl No.
1	Delay Time L	0.1ms – 1638.3ms	(1 – 16383)	
2	Delay Time R	0.1ms – 1638.3ms	(1 – 16383)	
3	Feedback Time 1	0.1ms – 1638.3ms	(1 – 16383)	
4	Feedback Time 2	0.1ms – 1638.3ms	(1 – 16383)	
5	Feedback Level	-63 – +63	(1 – 127)	
6	Feedback High Damp	0.1 – 1.0	(1 – 10)	
7	—			
8	—			
9	—			
10	Dry/Wet Balance	D63>W – D=W – D<W63	(1 – 127)	
11	—			
12	—			

13 – 16: Same as the parameters shaded in gray in CROSS DELAY on page 150.

[7] DELAY L, C, R

No.	Parameter	Range	Value	Tbl No.
1	Delay Time L	0.1ms – 1638.3ms	(1 – 16383)	13 – 16: Same as the parameters shaded in gray in CROSS DELAY on page 150.
2	Delay Time R	0.1ms – 1638.3ms	(1 – 16383)	
3	Delay Time C	0.1ms – 1638.3ms	(1 – 16383)	
4	Feedback Time	0.1ms – 1638.3ms	(1 – 16383)	
5	Feedback Level	-63 – +63	(1 – 127)	
6	Delay Level C	0 – 127	(0 – 127)	
7	Feedback High Damp	0.1 – 1.0	(1 – 10)	
8	—	—	—	
9	—	—	—	
10	Dry/Wet Balance	D63>W – D=W – D<W63	(1 – 127)	
11	—	—	—	
12	—	—	—	

[2] 2 MODULATOR

No.	Parameter	Range	Value	Tbl No.
1	LFO Speed	0.0Hz – 39.70Hz	(0 – 127)	1
2	AM Depth	0 – 127	(0 – 127)	
3	PM Depth	0 – 127	(0 – 127)	
4	Feedback Level	-63 – +63	(1 – 127)	
5	Delay Offset	0.0ms – 50.0ms	(0 – 127)	
6 – 9	Same as the parameters shaded in gray in CROSS DELAY on page 150.			
10	Dry / Wet Balance	D63>W – D=W – D<W63	(1 – 127)	3
11	EQ Mid Frequency	100Hz – 10.0kHz	(14 – 54)	
12	EQ Mid Gain	-12dB – +12dB	(52 – 76)	
13	EQ Mid Width	0.1 – 12.0	(1 – 120)	
14	—	—	—	
15	Input Mode	Mono, Stereo	(0 – 1)	
16	—	—	—	

[8] ANALOG DELAY RETRO

No.	Parameter	Range	Value	Tbl No.
1	Delay Time	25ms – 800ms	(0 – 127)	41
2	Feedback Level	0 – 127	(0 – 127)	
3	Delay Input Level	0 – 127	(0 – 127)	
4	Type	Mellow, Dub, Narrow, Soft, Dark	(0 – 4)	
5	—	—	—	
6	—	—	—	
7	—	—	—	
8	—	—	—	
9	—	—	—	
10	Dry/Wet Balance	D63>W – D=W – D<W63	(1 – 127)	
11	—	—	—	
12	—	—	—	
13	—	—	—	
14	—	—	—	
15	—	—	—	
16	—	—	—	

[3] SPX CHORUS

No.	Parameter	Range	Value	Tbl No.
1	LFO Speed	0.0Hz – 39.70Hz	(0 – 127)	1
2	LFO Depth	0 – 127	(0 – 127)	
3	Feedback Level	-63 – +63	(1 – 127)	
4	Delay Offset	0.0ms – 50.0ms	(0 – 127)	
5	—	—	—	
6 – 9	Same as the parameters shaded in gray in CROSS DELAY on page 150.			
10	Dry/Wet Balance	D63>W – D=W – D<W63	(1 – 127)	3
11	EQ Mid Frequency	100Hz – 10.0kHz	(14 – 54)	
12	EQ Mid Gain	-12dB – +12dB	(52 – 76)	
13	EQ Mid Width	0.1 – 12.0	(1 – 120)	
14	—	—	—	
15	Input Mode	Mono, Stereo	(0 – 1)	
16	—	—	—	

[9] ANALOG DELAY MODERN

No.	Parameter	Range	Value	Tbl No.
1	Delay Time	50ms – 1.0ms	(0 – 127)	42
2	Feedback Level	0 – 127	(0 – 127)	
3	Delay Input Level	0 – 127	(0 – 127)	
4	Type	Mellow, Dub, Narrow, Soft, Dark	(0 – 4)	
5	—	—	—	
6	—	—	—	
7	—	—	—	
8	—	—	—	
9	—	—	—	
10	Dry/Wet Balance	D63>W – D=W – D<W63	(1 – 127)	
11	—	—	—	
12	—	—	—	
13	—	—	—	
14	—	—	—	
15	—	—	—	
16	—	—	—	

[4] SYMPHONIC

No.	Parameter	Range	Value	Tbl No.
1	LFO Speed	0.0Hz – 39.70Hz	(0 – 127)	1
2	LFO Depth	0 – 127	(0 – 127)	
3	Delay Offset	0.0ms – 50.0ms	(0 – 127)	
4	—	—	—	
5	—	—	—	
6 – 9	Same as the parameters shaded in gray in CROSS DELAY on page 150.			
10	Dry/Wet Balance	D63>W – D=W – D<W63	(1 – 127)	3
11	EQ Mid Frequency	100Hz – 10.0kHz	(14 – 54)	
12	EQ Mid Gain	-12dB – +12dB	(52 – 76)	
13	EQ Mid Width	0.1 – 12.0	(1 – 120)	
14	—	—	—	
15	—	—	—	
16	—	—	—	

Category — CHORUS

[1] G CHORUS

No.	Parameter	Range	Value	Tbl No.
1	LFO Speed	0.0Hz – 39.70Hz	(0 – 127)	1
2	—	—	—	
3	PM Depth	0 – 127	(0 – 127)	
4	Feedback Level	-63 – +63	(1 – 127)	
5	Delay Offset	0.0ms – 50.0ms	(0 – 127)	
6 – 9	Same as the parameters shaded in gray in CROSS DELAY on page 150.			
10	Dry / Wet Balance	D63>W – D=W – D<W63	(1 – 127)	3
11	EQ Mid Frequency	100Hz – 10.0kHz	(14 – 54)	
12	EQ Mid Gain	-12dB – +12dB	(52 – 76)	
13	EQ Mid Width	0.1 – 12.0	(1 – 120)	
14	—	—	—	
15	Input Mode	Mono, Stereo	(0 – 1)	
16	—	—	—	

[5] ENSEMBLE DETUNE

No.	Parameter	Range	Value	Tbl No.
1	Detune	-50cent – +50cent	(14 – 114)	2
2	Initial Delay Lch	0.0ms – 50.0ms	(0 – 127)	
3	Initial Delay Rch	0.0ms – 50.0ms	(0 – 127)	
4	Spread	0 – 63	(0 – 63)	
5	—	—	—	11 – 14: Same as the parameters shaded in gray in CROSS DELAY on page 150.
6	—	—	—	
7	—	—	—	
8	—	—	—	
9	—	—	—	
10	Dry/Wet Balance	D63>W – D=W – D<W63	(1 – 127)	
11	—	—	—	
12	—	—	—	
13	—	—	—	
14	—	—	—	
15	—	—	—	
16	—	—	—	

Category — FLANGER

[1] VCM FLANGER

No.	Parameter	Range	Value	Tbl No.
1	Speed	0.040Hz – 10.00Hz	(0 – 235)	20
2	Manual	0 – 127	(0 – 127)	
3	Depth	0 – 127	(0 – 127)	
4	Feedback	0 – 127	(0 – 127)	
5	Type	1 – 3	(0 – 2)	
6	Spread	0 – 127	(0 – 127)	
7	Mix	0 – 127	(0 – 127)	
8	—			
9	—			
10	—			
11	—			
12	—			
13	—			
14	—			
15	—			
16	—			

[2] CLASSIC FLANGER

No.	Parameter	Range	Value	Tbl No.
1	LFO Speed	0.0Hz – 39.70Hz	(0 – 127)	1
2	LFO Depth	0 – 127	(0 – 127)	
3	LFO Wave	Triangle, Sine, Random	(0 – 2)	
4	Delay Offset	0.09 – 36.21ms	(0 – 139)	18
5	Feedback Level	-100 – +100%	(0 – 200)	
6 – 9	Same as the parameters shaded in gray in CROSS DELAY on page 150.			
10	Dry/Wet Balance	D63>W – D=W – D<W63	(1 – 127)	
11	EQ Mid Frequency	100Hz – 10.0kHz	(14 – 54)	3
12	EQ Mid Gain	-12dB – +12dB	(52 – 76)	
13	EQ Mid Width	0.1 – 12.0	(1 – 120)	
14	Modulation Phase	-180 – +180	(0 – 16)	19
15	Feedback High Damp	0.1 – 1.0	(1 – 10)	
16	Analog Feel	0 – 10	(0 – 10)	

[3] TEMPO FLANGER

No.	Parameter	Range	Value	Tbl No.
1	LFO Speed	16th – 4thx16	(5 – 29)	13
2	LFO Depth	0 – 127	(0 – 127)	
3	Feedback Level	-63 – +63	(1 – 127)	
4	Delay Offset	0.0ms – 50.0ms	(0 – 127)	2
5	LFO Phase Reset	Off (free run), Key On Reset, SEQ Start Reset	(0 – 2)	
6 – 9	Same as the parameters shaded in gray in CROSS DELAY on page 150.			
10	Dry/Wet Balance	D63>W – D=W – D<W63	(1 – 127)	
11	EQ Mid Frequency	100Hz – 10.0kHz	(14 – 54)	3
12	EQ Mid Gain	-12dB – +12dB	(52 – 76)	
13	EQ Mid Width	0.1 – 12.0	(1 – 120)	
14	LFO Phase Difference	-180deg – +180deg	(4 – 124)	
15	—			
16	—			

[4] DYNAMIC FLANGER

No.	Parameter	Range	Value	Tbl No.
1	Sensitivity	0 – 127	(0 – 127)	
2	Delay Offset	0 – 127	(0 – 127)	
3	Feedback Level	-63 – +63	(1 – 127)	
4	Attack Time	0.3ms – 227ms	(0 – 127)	15
5	Release Time	2.6ms – 2171ms	(0 – 127)	16
6	Release Curve	0 – 127	(0 – 127)	
7	Direction	Up, Down	(0 – 1)	
8	Dyna Threshold Level	0 – 127	(0 – 127)	
9	Dyna Level Offset	0 – 127	(0 – 127)	
10	Dry/Wet Balance	D63>W – D=W – D<W63	(1 – 127)	
11	—			
12	Side Chain Input Level	--dB – 0dB – +24dB	(0 – 127)	45
13 – 16	Same as the parameters shaded in gray in CROSS DELAY on page 150.			

[5] CONTROL FLANGER

No.	Parameter	Range	Value	Tbl No.
1	Flanger Control	0 – 127	(0 – 127)	
2	Bottom	0 – 127	(0 – 127)	
3	Top	0 – 127	(0 – 127)	
4	Feedback	0 – 127	(0 – 127)	
5	Type	1 – 3	(0 – 2)	
6	Spread	0 – 127	(0 – 127)	
7	Mix	0 – 127	(0 – 127)	
8	—			
9	—			
10	—			
11	—			
12	—			
13	—			
14	—			
15	—			
16	—			

Category — PHASER

[1] VCM PHASER MONO

No.	Parameter	Range	Value	Tbl No.
1	Speed	0.100Hz – 10.00Hz	(0 – 252)	21
2	Manual	0 – 127	(0 – 127)	
3	Depth	0 – 127	(0 – 127)	
4	Feedback	0 – 127	(0 – 127)	
5	Stage	4, 6, 8, 10, 12, 16	(0 – 5)	
6	Mode	1, 2, 3	(0 – 2)	
7	Color	0 – 127	(0 – 127)	
8	—			
9	—			
10	—			
11	—			
12	—			
13	—			
14	—			
15	—			
16	—			

The Color parameter is not available in the following conditions: When Mode is set to 1 and Stage is set to 4, 6, 8, 12 or 16; or when Mode is set to 2 and Stage is set to 4 or 10.

[2] VCM PHASER STEREO

No.	Parameter	Range	Value	Tbl No.
1	Speed	0.100Hz – 10.00Hz	(0 – 252)	21
2	Manual	0 – 127	(0 – 127)	
3	Depth	0 – 127	(0 – 127)	
4	Feedback	0 – 127	(0 – 127)	
5	Stage	4, 6, 8, 10	(0 – 3)	
6	Mode	1, 2	(0 – 1)	
7	Color	0 – 127	(0 – 127)	
8	Spread	0 – 127	(0 – 127)	
9	—			
10	—			
11	—			
12	—			
13	—			
14	—			
15	—			
16	—			

The Color parameter is not available in the following conditions: When Mode is set to 1 and Stage is set to 4, 6, or 8; or when Mode is set to 2 and Stage is set to 4 or 10.

[3] TEMPO PHASER

No.	Parameter	Range	Value	Tbl No.
1	LFO Speed	16th – 4thx16	(5 – 29)	13
2	LFO Depth	0 – 127	(0 – 127)	
3	Phase Shift Offset	0 – 127	(0 – 127)	
4	Feedback Level	-63 – +63	(1 – 127)	
5	LFO Phase Reset	Off (free run), Key On Reset, SEQ Start Reset	(0 – 2)	
6 – 9: Same as the parameters shaded in gray in CROSS DELAY on page 150.				
10	Dry/Wet Balance	D63>W – D=W – D<W63	(1 – 127)	
11	Stage	4 – 22	(4 – 22)	
12	Diffusion	Mono, Stereo	(0 – 1)	
13	—			
14	—			
15	—			
16	—			

[4] DYNAMIC PHASER

No.	Parameter	Range	Value	Tbl No.
1	Sensitivity	0 – 127	(0 – 127)	
2	Dyna Level Offset	0 – 127	(0 – 127)	
3	Feedback Level	-63 – +63	(1 – 127)	
4	Attack Time	0.3ms – 227ms	(0 – 127)	15
5	Release Time	2.6ms – 2171ms	(0 – 127)	16
6	Release Curve	0 – 127	(0 – 127)	
7	Direction	up, down	(0 – 1)	
8	Dyna Threshold Level	0 – 127	(0 – 127)	
9	—			
10	Dry/Wet Balance	D63>W – D=W – D<W63	(1 – 127)	
11	Stage	4, 5, 6	(4 – 6)	
12	Side Chain Input Level	--dB – 0dB – +24dB	(0 – 127)	45
13 – 16: Same as the parameters shaded in gray in CROSS DELAY on page 150.				

[5] CONTROL PHASER

No.	Parameter	Range	Value	Tbl No.
1	Phase Control	0 – 127	(0 – 127)	
2	Bottom	0 – 127	(0 – 127)	
3	Top	0 – 127	(0 – 127)	
4	Feedback	0 – 127	(0 – 127)	
5	Stage	4, 6, 8, 10	(0 – 3)	
6	Mode	1, 2	(0 – 1)	
7	Color	0 – 127	(0 – 127)	
8	Spread	0 – 127	(0 – 127)	
9	—			
10	—			
11	—			
12	—			
13	—			
14	—			
15	—			
16	—			

Category — TREMOLO&ROTARY

[1] AUTO PAN

No.	Parameter	Range	Value	Tbl No.
1	LFO Speed	0.0Hz – 39.70Hz	(0 – 127)	1
2	L/R Depth	0 – 127	(0 – 127)	
3	F/R Depth	0 – 127	(0 – 127)	
4	Pan Direction	L<>R, L>>R, L<<R, L turn, R turn, L/R	(0 – 5)	
5	LFO Wave	0 – 28	(0 – 28)	
6 – 9: Same as the parameters shaded in gray in CROSS DELAY on page 150.				
10	—			
11	EQ Mid Frequency	100Hz – 10.0kHz	(14 – 54)	3
12	EQ Mid Gain	-12dB – +12dB	(52 – 76)	
13	EQ Mid Width	0.1 – 12.0	(1 – 120)	
14	—			
15	Input Mode	Mono, Stereo	(0 – 1)	
16	—			

[2] TREMOLO

No.	Parameter	Range	Value	Tbl No.
1	LFO Speed	0.0Hz – 39.70Hz	(0 – 127)	1
2	AM Depth	0 – 127	(0 – 127)	
3	PM Depth	0 – 127	(0 – 127)	
4	—			

No.	Parameter	Range	Value	Tbl No.
5	—			
6 – 9: Same as the parameters shaded in gray in CROSS DELAY on page 150.				
10	—			
11	EQ Mid Frequency	100Hz – 10.0kHz	(14 – 54)	3
12	EQ Mid Gain	-12dB – +12dB	(52 – 76)	
13	EQ Mid Width	0.1 – 12.0	(1 – 120)	
14	LFO Phase difference	-180deg – +180deg	(4 – 124)	
15	Input Mode	Mono, Stereo	(0 – 1)	
16	—			

[3] ROTARY SPEAKER 1

No.	Parameter	Range	Value	Tbl No.
1	Rotor Speed Slow	0.0Hz – 2.65Hz	(0 – 63)	1
2	Horn Speed Slow	0.0Hz – 2.65Hz	(0 – 63)	1
3	Rotor Speed Fast	0.0Hz – 39.70Hz	(64 – 127)	1
4	Horn Speed Fast	0.0Hz – 39.70Hz	(64 – 127)	1
5	Slow-Fast Time of Rotor	0 – 127	(0 – 127)	
6	Slow-Fast Time of Horn	0 – 127	(0 – 127)	
7	Drive Rotor	0 – 127	(0 – 127)	
8	Drive Horn	0 – 127	(0 – 127)	
9	Rotor/Horn Balance	R63>H – R=H – R<H63	(1 – 127)	
10	—			
11 – 14: Same as the parameters shaded in gray in CROSS DELAY on page 150.				
15	Mic L-R Angle	0deg – 180deg	(0 – 60)	
16	Speed Control	Slow, Fast	(0 – 1)	

[4] ROTARY SPEAKER 2

No.	Parameter	Range	Value	Tbl No.
1	Speed Control	Slow, Fast	(0 – 1)	
2	Drive	0.0 – 10.0	(0 – 100)	
3	Tone	0.0 – 10.0	(0 – 100)	
4	Rotor/Horn Balance	R63>H – R=H – R<H63	(1 – 127)	
5	Output Level	0 – 127	(0 – 127)	
6	Mic L-R Angle	0deg, 90deg, 120deg, 180deg	(0 – 3)	
7	Input Level	-6dB – 0dB – +6dB	(52 – 76)	
8	Modulation Depth	0 – 63	(0 – 63)	
9	—			
10	—			
11	Slow-Fast Time of Horn	x0.21 – x1.00 – x2.00	(14 – 127)	49
12	Fast-Slow Time of Horn	x0.21 – x1.00 – x2.00	(14 – 127)	49
13	Rotor Speed Slow	0.0rpm – 88.3rpm	(0 – 127)	56
14	Horn Speed Slow	0.0rpm – 89.6rpm	(0 – 127)	57
15	Rotor Speed Fast	189.3rpm – 736.8rpm	(1 – 127)	58
16	Horn Speed Fast	209.4rpm – 817.6rpm	(1 – 127)	59
17	Slow-Fast Time of Rotor	x0.21 – x1.00 – x2.00	(14 – 127)	49
18	Fast-Slow Time of Rotor	x0.21 – x1.00 – x2.00	(14 – 127)	49

Category — DISTORTION

[1] AMP SIMULATOR 1

No.	Parameter	Range	Value	Tbl No.
1	Overdrive	0 – 100%	(0 – 100)	
2	Device	Transistor, Vintage Tube, Distortion1, Distortion2, Fuzz	(0 – 4)	
3	Speaker Type	Flat, Stack, Combo, Twin, Radio, Megaphone	(0 – 5)	
4	Presence	-10 – 10	(0 – 20)	
5	Output Level	0 – 100%	(0 – 100)	
6	—			
7	—			
8	—			
9	—			
10	Dry/Wet Balance	D63>W – D=W – D<W63	(1 – 127)	
11	—			
12	—			
13	—			
14	—			
15	—			
16	—			

[2] AMP SIMULATOR 2

No.	Parameter	Range	Value	Tbl No.
1	Overdrive	0 – 127	(0 – 127)	
2	AMP Type	Off, Stack, Combo, Tube, Crunch, Hi Gain, British	(0 – 6)	
3	LPF Cutoff Frequency	1.0kHz – 20.0kHz	(34 – 60)	3
4	Output Level	0 – 127	(0 – 127)	
5	—			
6	—			
7	—			
8	—			
9	—			
10	Dry/Wet Balance	D63>W – D=W – D<W63	(1 – 127)	
11	—			
12	—			
13	—			
14	—			
15	—			
16	—			

[3] COMP DISTORTION

No.	Parameter	Range	Value	Tbl No.
1	Overdrive	0 – 127	(0 – 127)	
2	EQ Low Frequency	32Hz – 2.0kHz	(4 – 40)	3
3	EQ Low Gain	-12dB – +12dB	(52 – 76)	
4	LPF Cutoff Frequency	1.0kHz – 20.0kHz	(34 – 60)	3
5	Output Level	0 – 127	(0 – 127)	
6	—			
7	EQ Mid Frequency	100Hz – 10.0kHz	(14 – 54)	3
8	EQ Mid Gain	-12dB – +12dB	(52 – 76)	
9	EQ Mid Width	0.1 – 12.0	(1 – 120)	
10	Dry / Wet Balance	D63>W – D=W – D<W63	(1 – 127)	
11	Edge	0 – 127	(0 – 127)	
12	Attack	1ms – 40ms	(0 – 19)	8
13	Release	10ms – 680ms	(0 – 15)	9
14	Threshold	-48dB – -6dB	(79 – 121)	
15	Ratio	1.0 – 20.0	(0 – 7)	10
16	—			

[4] COMP DISTORTION DELAY

No.	Parameter	Range	Value	Tbl No.
1	Overdrive	0 – 100%	(0 – 100)	
2	Device	Transistor, Vintage Tube, Distortion1, Distortion2, Fuzz	(0 – 4)	
3	Speaker Type	Flat, Stack, Combo, Twin, Radio, Megaphone	(0 – 5)	
4	Presence	-10 – 10	(0 – 20)	
5	Output Level	0 – 100%	(0 – 100)	
6	Delay Time L	0.1ms – 1638.3ms	(1 – 16383)	
7	Delay Time R	0.1ms – 1638.3ms	(1 – 16383)	
8	Feedback Time	0.1ms – 1638.3ms	(1 – 16383)	
9	Feedback Level	-63 – +63	(1 – 127)	
10	Dry/Wet Balance	D63>W – D=W – D<W63	(1 – 127)	
11	Delay Mix	0 – 127	(0 – 127)	
12	Feedback High Damp	0.1 – 1.0	(1 – 10)	
13	Compress	-48dB – -6dB	(79 – 121)	
14	—			
15	—			
16	—			

[5] US COMBO

No.	Parameter	Range	Value	Tbl No.
1	Gain Boost	Low, High	(0 – 1)	
2	Volume	0.0 – 10.0	(0 – 100)	
3	Low Cut	0.0 – 10.0	(0 – 100)	
4	Mid Cut	0.0 – 10.0	(0 – 100)	
5	Mid Width	0.0 – 10.0	(0 – 100)	
6	Mid Sweep	0.0 – 10.0	(0 – 100)	
7	High Cut	0.0 – 10.0	(0 – 100)	
8	Balance	0.0 – 10.0	(0 – 100)	
9	Output Level	0 – 127	(0 – 127)	
10	—			
11	Speaker Type	Off, BS 4x12, AC 2x12, AC 1x12, AC 4x10, BC 2x12, AM 4x12, YC 4x12, JC 2x12, OC 2x12, OC 1x8	(0 – 10)	30
12	Speaker Air	0 – 2	(0 – 2)	
13	Mic Position	Center, Edge	(0 – 1)	
14	Presence	0.0 – 10.0	(0 – 100)	
15	—			

No.	Parameter	Range	Value	Tbl No.
16	—			

[6] JAZZ COMBO

No.	Parameter	Range	Value	Tbl No.
1	Panning	0.0 – 10.0	(0 – 100)	
2	Volume	0.0 – 10.0	(0 – 100)	
3	Distortion	Off, 0.1 – 10.0	(0 – 100)	
4	Bass	0.0 – 10.0	(0 – 100)	
5	Middle	0.0 – 10.0	(0 – 100)	
6	Treble	0.0 – 10.0	(0 – 100)	
7	High Treble	0.0 – 10.0	(0 – 100)	
8	—			
9	Output Level	0 – 127	(0 – 127)	
10	—			
11	Speaker Type	Off, BS 4x12, AC 2x12, AC 1x12, AC 4x10, BC 2x12, AM 4x12, YC 4x12, JC 2x12, OC 2x12, OC 1x8	(0 – 10)	30
12	Speaker Air	0 – 2	(0 – 2)	
13	Mic Position	Center, Edge	(0 – 1)	
14	Chorus	Off, Chorus, Vib	(0 – 2)	
15	Vib Speed	0.0 – 10.0	(0 – 100)	
16	Depth	0.0 – 10.0	(0 – 100)	

[7] US HIGH GAIN

No.	Parameter	Range	Value	Tbl No.
1	Type	Raw1, Vintage1, Modern1, Raw2, Vintage2, Modern2	(0 – 5)	35
2	Gain	0.0 – 10.0	(0 – 100)	
3	—			
4	Bass	0.0 – 10.0	(0 – 100)	
5	Middle	0.0 – 10.0	(0 – 100)	
6	Treble	0.0 – 10.0	(0 – 100)	
7	Presence	0.0 – 10.0	(0 – 100)	
8	Master Volume	0.0 – 10.0	(0 – 100)	
9	Output Level	0 – 127	(0 – 127)	
10	—			
11	Speaker Type	Off, BS 4x12, AC 2x12, AC 1x12, AC 4x10, BC 2x12, AM 4x12, YC 4x12, JC 2x12, OC 2x12, OC 1x8	(0 – 10)	30
12	Speaker Air	0 – 2	(0 – 2)	
13	Mic Position	Center, Edge	(0 – 1)	
14	—			
15	—			
16	—			

[8] BRITISH LEAD

No.	Parameter	Range	Value	Tbl No.
1	Type	Crunch, Hi-Gain, Lead	(0 – 2)	
2	Preamp	0.0 – 10.0	(0 – 100)	
3	Tone Shift	Normal, Loose, Tight	(0 – 2)	
4	Bass	0.0 – 10.0	(0 – 100)	
5	Middle	0.0 – 10.0	(0 – 100)	
6	Treble	0.0 – 10.0	(0 – 100)	
7	Presence	0.0 – 10.0	(0 – 100)	
8	Master Volume	0.0 – 10.0	(0 – 100)	
9	Output Level	0 – 127	(0 – 127)	
10	—			
11	Speaker Type	Off, BS 4x12, AC 2x12, AC 1x12, AC 4x10, BC 2x12, AM 4x12, YC 4x12, JC 2x12, OC 2x12, OC 1x8	(0 – 10)	30
12	Speaker Air	0 – 2	(0 – 2)	
13	Mic Position	Center, Edge	(0 – 1)	
14	—			
15	—			
16	—			

[9] MULTI FX

No.	Parameter	Range	Value	Tbl No.
1	Comp. Sustain	Off, 0.1 – 10.0	(0 – 100)	
2	Wah SW	Off, Wah Pedal, Auto+ Full, Auto+ Mid, Auto+ Light, Auto- Full, Auto- Mid, Auto- Light	(0 – 7)	33
3	Wah Pedal	0 – 127	(0 – 127)	
4	Dist SW	Off, Overdrive, Distortion1, Distortion2, Clean, Crunch, Hi-Gain, Modern	(0 – 7)	34
5	Dist Drive	0.0 – 10.0	(0 – 100)	
6	Dist EQ	High Boost, Mid Boost, Mid Cut 1, Mid Cut 2, Mid Cut 3, Low Cut 1, Low Cut 2, High Cut, High/Low	(0 – 8)	35
7	Dist Tone	0.0 – 10.0	(0 – 100)	
8	Dist Presence	0.0 – 10.0	(0 – 100)	
9	Output Level	0 – 127	(0 – 127)	
10	—			
11	Speaker Type	Off, Stack, Twin, Tweed, Oldies, Modern, Mean, Soft, Small, Dip1, Dip2, Metal, Light	(0 – 12)	31
12	LFO Speed	0.1Hz – 9.925Hz	(0 – 127)	36
13	Phaser SW	Off, Standard, Wide, Vibe, Tremolo	(0 – 4)	37
14	Delay SW	Off, Delay M, Echo1 M, Echo2 M, Chorus M, Dly Chorus M, Flanger1 M, Flanger2 M, Flanger3 M, Delay St, Echo1 St, Echo2 St, Chorus St, DI Chorus St, Flanger1 St, Flanger2 St, Flanger3 St	(0 – 16)	38
15	Delay Ctrl	0 – 127	(0 – 127)	
16	Delay Time	0 – 127	(0 – 127)	

[10] SMALL STEREO

No.	Parameter	Range	Value	Tbl No.
1	Comp. SW	Off, On	(0 – 1)	
2	Comp. Sustain	0.0 – 10.0	(0 – 100)	
3	Comp. Level	0.0 – 10.0	(0 – 100)	
4	Dist Type	Overdrive, Distortion1, Distortion2, Clean, Crunch, Hi-Gain, Modern	(1 – 7)	34
5	Dist Drive	0.0 – 10.0	(0 – 100)	
6	Dist EQ	High Boost, Mid Boost, Mid Cut 1, Mid Cut 2, Mid Cut 3, Low Cut 1, Low Cut 2, High Cut, High/Low	(0 – 8)	35
7	Dist Tone	0.0 – 10.0	(0 – 100)	
8	Dist Presence	0.0 – 10.0	(0 – 100)	
9	Output Level	0 – 127	(0 – 127)	
10	—			
11	Speaker Type	Off, Stack, Twin, Tweed, Oldies, Modern, Mean, Soft, Small, Dip1, Dip2, Metal, Light	(0 – 12)	31
12	—			
13	—			
14	—			
15	—			
16	—			

[11] BRITISH COMBO

No.	Parameter	Range	Value	Tbl No.
1	Mode	Bright, Top Boost	(0 – 1)	
2	Normal	0.0 – 10.0	(0 – 100)	
3	Brilliant	0.0 – 10.0	(0 – 100)	
4	Bass	0.0 – 10.0	(0 – 100)	
5	—			
6	Treble	0.0 – 10.0	(0 – 100)	
7	Cut	0.0 – 10.0	(0 – 100)	
8	—			
9	Output Level	0 – 127	(0 – 127)	
10	—			
11	Speaker Type	Off, BS 4x12, AC 2x12, AC 1x12, AC 4x10, BC 2x12, AM 4x12, YC 4x12, JC 2x12, OC 2x12, OC 1x8	(0 – 10)	30
12	Speaker Air	0 – 2	(0 – 2)	
13	Mic Position	Center, Edge	(0 – 1)	
14	—			
15	—			
16	—			

[12] BRITISH LEGEND

No.	Parameter	Range	Value	Tbl No.
1	Sensitivity	High, Low	(0 – 1)	
2	Preamp	0.0 – 10.0	(0 – 100)	
3	—			
4	Bass	0.0 – 10.0	(0 – 100)	

No.	Parameter	Range	Value	Tbl No.
5	Middle	0.0 – 10.0	(0 – 100)	
6	Treble	0.0 – 10.0	(0 – 100)	
7	Presence	0.0 – 10.0	(0 – 100)	
8	Master Volume	0.0 – 10.0	(0 – 100)	
9	Output Level	0 – 127	(0 – 127)	
10	—			
11	Speaker Type	Off, BS 4x12, AC 2x12, AC 1x12, AC 4x10, BC 2x12, AM 4x12, YC 4x12, JC 2x12, OC 2x12, OC 1x8	(0 – 10)	30
12	Speaker Air	0 – 2	(0 – 2)	
13	Mic Position	Center, Edge	(0 – 1)	
14	—			
15	—			
16	—			

Category — COMPRESSOR**[1] VCM COMPRESSOR 376**

No.	Parameter	Range	Value	Tbl No.
1	Input Level	-∞ – 0.00dB	(0 – 200)	25
2	Output Level	-∞ – 0.00dB	(0 – 200)	25
3	Ratio	2, 4, 8, 12, 20	(0 – 4)	
4	Attack	0.022ms – 50.40ms	(0 – 200)	26
5	Release	10.88ms – 544.22ms	(0 – 200)	27
6	Meter	OUT, GR	(0 – 1)	
7	—			
8	—			
9	—			
10	—			
11	Side Chain Input Level	-∞dB – 0dB – +24dB	(0 – 127)	45
12	—			
13	—			
14	—			
15	—			
16	—			

[2] CLASSIC COMPRESSOR

No.	Parameter	Range	Value	Tbl No.
1	Attack	1ms – 40ms	(0 – 19)	8
2	Release	10ms – 680ms	(0 – 15)	9
3	Threshold	-48dB – -6dB	(79 – 121)	
4	Ratio	1.0 – 20.0	(0 – 7)	10
5	Output Level	0 – 127	(0 – 127)	
6	—			
7	—			
8	—			
9	—			
10	—			
11	Side Chain Input Level	-∞dB – 0dB – +24dB	(0 – 127)	45
12	—			
13	—			
14	—			
15	—			
16	—			

[3] MULTI BAND COMP

No.	Parameter	Range	Value	Tbl No.
1	Low Attack	1ms – 200ms	(0 – 29)	8
2	Low Threshold	-54dB – -6dB	(73 – 121)	
3	Low Ratio	1.0 – 20.0	(0 – 7)	10
4	Low Gain	-∞ – +18dB	(0 – 55)	14
5	Mid Attack	1ms – 200ms	(0 – 29)	8
6	Mid Threshold	-54dB – -6dB	(73 – 121)	
7	Mid Ratio	1.0 – 20.0	(0 – 7)	10
8	Mid Gain	-∞ – +18dB	(0 – 55)	14
9	High Attack	1ms – 200ms	(0 – 29)	8
10	High Threshold	-54dB – -6dB	(73 – 121)	
11	High Ratio	1.0 – 20.0	(0 – 7)	10
12	High Gain	-∞ – +18dB	(0 – 55)	14
13	Divide Freq Low	16Hz – 20kHz	(0 – 124)	28
14	Divide Freq High	16Hz – 20kHz	(0 – 124)	28
15	Common Release	10ms – 3000ms	(0 – 23)	9
16	Side Chain Input Level	-∞dB – 0dB – +24dB	(0 – 127)	45

[4] UNIVERSAL COMPRESSOR DOWN

No.	Parameter	Range	Value	Tbl No.
1	Threshold	-60dB – 0dB	(0 – 120)	
2	Knee	0 – 8	(0 – 8)	
3	Attack	0.01ms – 80ms	(0 – 127)	50
4	Release	6.25ms – 999.0ms	(0 – 127)	51
5	Ratio	1.00 – ∞	(0 – 127)	52
6	Side Chain EQ Switch	Off, On	(0 – 1)	
7	Side Chain EQ Q	0.1 – 10.0	(0 – 126)	53
8	Side Chain EQ Frequency	11.89Hz – 17.78kHz	(0 – 127)	54
9	Side Chain EQ Gain	-30 – +30 dB	(0 – 120)	
10	Dry/Wet Balance	D63>W – D=W – D<W63	(1 – 127)	
11	Output Level	-20 – +40 dB	(0 – 120)	
12	Make Up Gain	-20 – +40 dB	(0 – 120)	
13	Post-comp HPF	Off, 1.035Hz – 80.35Hz	(0 – 127)	55
14	Clipper	Off, 1 – 100	(0 – 100)	
15	Clipper Source	Dry+Wet, Wet	(0 – 1)	
16	—	—	—	—
17	Side Chain Input Level	-∞dB – 0dB – +24dB	(0 – 127)	45

For the Variation block, the value of the Clipper Source is fixed to Wet.

[5] UNIVERSAL COMPRESSOR UP

No.	Parameter	Range	Value	Tbl No.
1	Threshold	-60dB – 0dB	(0 – 120)	
2	Knee	0 – 8	(0 – 8)	
3	Attack	0.01ms – 80ms	(0 – 127)	50
4	Release	6.25ms – 999.0ms	(0 – 127)	51
5	Ratio	1 – ∞	(0 – 127)	52
6	Side Chain EQ Switch	Off, On	(0 – 1)	
7	Side Chain EQ Q	0.1 – 10.0	(0 – 126)	53
8	Side Chain EQ Frequency	11.89Hz – 17.78kHz	(0 – 127)	54
9	Side Chain EQ Gain	-30 – +30 dB	(0 – 120)	
10	Dry/Wet Balance	D63>W – D=W – D<W63	(1 – 127)	
11	Output Level	-20 – +40 dB	(0 – 120)	
12	Make Up Gain	-20 – +20 dB	(0 – 80)	
13	Post-comp HPF	Off, 1.035Hz – 80.35Hz	(0 – 127)	55
14	Clipper	Off, 1 – 100	(0 – 100)	
15	Clipper Source	Dry+Wet, Wet	(0 – 1)	
16	Gain Limit	0 – +12dB	(0 – 120)	
17	Side Chain Input Level	-∞dB – 0dB – +24dB	(0 – 127)	45

For the Variation block, the value of the Clipper Source is fixed to Wet.

[6] PARALLEL COMPRESSOR

No.	Parameter	Range	Value	Tbl No.
1	Type	Natural, Rich, Punchy, Electronic, Loud	(0 – 4)	
2	Compression	0 – 100	(0 – 100)	
3	Texture	0 – 100	(0 – 100)	
4	Output Level	-18dB – +18dB	(0 – 120)	
5	Input Level	-18dB – +18dB	(0 – 120)	
6	—	—	—	—
7	—	—	—	—
8	—	—	—	—
9	—	—	—	—
10	—	—	—	—
11	—	—	—	—
12	—	—	—	—
13	—	—	—	—
14	—	—	—	—
15	—	—	—	—
16	—	—	—	—

Category — WAH

[1] VCM AUTO WAH

No.	Parameter	Range	Value	Tbl No.
1	Speed	0.100Hz – 20.00Hz	(0 – 254)	22
2	Bottom	0 – 127	(0 – 127)	
3	Top	0 – 127	(0 – 127)	
4	Resonance Offset	-12.0 – +12.0	(40 – 88)	
5	LFO Wave	Sin, Trp	(0 – 1)	
6	Type	High, Mid, Low, Bass	(0 – 3)	
7	Overdrive	0.0dB – +40.0dB	(0 – 80)	
8	Output	-20.0dB – +10.0dB	(24 – 84)	
9	—	—	—	—
10	—	—	—	—
11	—	—	—	—
12	—	—	—	—
13	—	—	—	—
14	—	—	—	—
15	—	—	—	—
16	—	—	—	—

When the value of Bottom is greater than Top, the sound will not be modulated and only the Bottom value is available.

[2] VCM TOUCH WAH

No.	Parameter	Range	Value	Tbl No.
1	Sensitivity	0 – 127	(0 – 127)	
2	Bottom	0 – 127	(0 – 127)	
3	Top	0 – 127	(0 – 127)	
4	Resonance Offset	-12.0 – +12.0	(40 – 88)	
5	Direction	Up, Down	(0 – 1)	
6	Type	High, Mid, Low, Bass	(0 – 3)	
7	Overdrive	0.0dB – +40.0dB	(0 – 80)	
8	Output	-20.0dB – +10.0dB	(24 – 84)	
9	—	—	—	—
10	—	—	—	—
11	Attack Offset	-5 – +5	(59 – 69)	
12	—	—	—	—
13	—	—	—	—
14	—	—	—	—
15	—	—	—	—
16	—	—	—	—

When the value of Bottom is greater than Top, the sound will not be modulated and only the Bottom value is available.

[3] VCM PEDAL WAH

No.	Parameter	Range	Value	Tbl No.
1	Pedal Control	0 – 127	(0 – 127)	
2	Bottom	0 – 127	(0 – 127)	
3	Top	0 – 127	(0 – 127)	
4	Resonance Offset	-12.0 – +12.0	(40 – 88)	
5	Direction	Up, Down	(0 – 1)	
6	Type	High, Mid, Low, Bass	(0 – 3)	
7	Overdrive	0.0dB – +40.0dB	(0 – 80)	
8	Output	-20.0dB – +10.0dB	(24 – 84)	
9	—	—	—	—
10	—	—	—	—
11	—	—	—	—
12	—	—	—	—
13	—	—	—	—
14	—	—	—	—
15	—	—	—	—
16	—	—	—	—

When the value of Bottom is greater than Top, the sound will not be modulated and only the Bottom value is available.

Category — Lo-Fi

[1] LO-FI

No.	Parameter	Range	Value	Tbl No.
1	Sampling Frequency Control	44.1 – 344Hz	(0 – 127)	12
2	Word Length	1 – 127	(1 – 127)	
3	Output Level	-6dB – +36dB	(0 – 42)	
4	Pre-LPF Cutoff Frequency	63Hz – 20.0kHz	(10 – 60)	3
5	Filter Type	Thru, PowerBass, Radio, Telephone, Clean, Low	(0 – 5)	
6	Pre-LPF Resonance	1.0 – 12.0	(10 – 120)	
7	Bit Assign	0 – 6	(0 – 6)	
8	Emphasis	Off, On	(0 – 1)	
9	—			
10	Dry/Wet Balance	D63>W – D=W – D<W63	(1 – 127)	
11	—			
12	—			
13	—			
14	—			
15	Input Mode	Mono, Stereo	(0 – 1)	
16	—			

[2] NOISY

No.	Parameter	Range	Value	Tbl No.
1	Mod Depth	0 – 10	(0 – 10)	
2	Mod Speed	0 – 127	(0 – 127)	
3	Mod Feedback	-63 – +63	(1 – 127)	
4	Mod Mix Balance	1 – 127	(1 – 127)	
5	Drive	0 – 127	(0 – 127)	
6	AM Speed	0.00Hz – 39.7Hz	(0 – 127)	1
7	AM Depth	0 – 127	(0 – 127)	
8	LPF Cutoff Frequency	1.0kHz – 20.0kHz	(34 – 60)	3
9	LPF Resonance	1.0 – 12.0	(10 – 120)	
10	Dry/Wet Balance	D63>W – D=W – D<W63	(1 – 127)	
11	EQ Frequency	100Hz – 10.0kHz	(14 – 54)	3
12	EQ Gain	-12 – +12dB	(52 – 76)	
13	EQ Width	1.0 – 12.0	(10 – 120)	
14	—			
15	—			
16	—			

[3] DIGITAL TURNTABLE

No.	Parameter	Range	Value	Tbl No.
1	Click Density	0 – 5	(0 – 5)	
2	Click Level	0 – 127	(0 – 127)	
3	Noise Tone	0 – 6	(0 – 6)	
4	Noise Mod Speed	0.00Hz – 39.7Hz	(0 – 127)	1
5	Noise Mod Depth	0 – 127	(0 – 127)	
6	Dry Send to Noise	0 – 127	(0 – 127)	
7	Noise LPF Cutoff Frequency	1.0kHz – 20.0kHz	(34 – 60)	3
8	Noise LPF Q	1.0 – 12.0	(10 – 120)	
9	Noise Level	0 – 127	(0 – 127)	
10	—			
11	Dry Level	0 – 127	(0 – 127)	
12	Dry LPF Cutoff Frequency	1.0kHz – 20.0kHz	(34 – 60)	3
13	—			
14	—			
15	—			
16	—			

[4] BIT CRUSHER

No.	Parameter	Range	Value	Tbl No.
1	Sample Rate	0 – 100.00	(0 – 16383)	
2	Bit	1 – 16	(1 – 16)	
3	Crush Type	Soft, Hard	(0 – 1)	
4	Input Level	-19.5dB – +12dB	(1 – 127)	47
5	M/S	Off, On	(0 – 1)	
6	Side Sample Rate	0 – 100.00	(0 – 16383)	
7	Side Bit	1 – 16	(1 – 16)	
8	Sample Rate Link	-1.0 – +1.0	(0 – 100)	
9	Bit Link	-1.0 – +1.0	(0 – 100)	
10	Dry/Wet Balance	D63>W – D=W – D<W63	(1 – 127)	
11	Output Level	-19.5dB – +12dB	(1 – 127)	47
12	—			
13	—			
14	—			
15	—			
16	—			

Category — TEC

[1] RING MODULATOR

No.	Parameter	Range	Value	Tbl No.
1	OSC Frequency Coarse	0.5 – 5kHz	(0 – 127)	17
2	OSC Frequency Fine	0 – 127	(0 – 127)	
3	LFO Wave	Tri, Sine	(0 – 1)	
4	LFO Depth	0 – 127	(0 – 127)	
5	LFO Speed	0.0Hz – 39.70Hz	(0 – 127)	1
6	HPF Cutoff Frequency	20Hz – 8.0kHz	(0 – 52)	3
7	LPF Cutoff Frequency	1.0kHz – 20.0kHz	(34 – 60)	3
8	—			
9	—			
10	Dry/Wet Balance	D63>W – D=W – D<W63	(1 – 127)	
11	—			
12	Modulator Input Level	--dB – 0dB – +24dB	(0 – 127)	45

13 – 16: Same as the parameters shaded in gray in CROSS DELAY on page 150.

[2] DYNAMIC RING MODULATOR

No.	Parameter	Range	Value	Tbl No.
1	Sensitivity	0 – 127	(0 – 127)	
2	HPF Cutoff Frequency	20Hz – 8.0kHz	(0 – 52)	3
3	LPF Cutoff Frequency	1.0kHz – 20.0kHz	(34 – 60)	3
4	Attack Time	0.3ms – 227ms	(0 – 127)	15
5	Release Time	2.6ms – 2171ms	(0 – 127)	16
6	Release Curve	0 – 127	(0 – 127)	
7	Direction	Up, Down	(0 – 1)	
8	Dyna Threshold Level	0 – 127	(0 – 127)	
9	Dyna Level Offset	0 – 127	(0 – 127)	
10	Dry/Wet Balance	D63>W – D=W – D<W63	(1 – 127)	
11	—			
12	Side Chain Input Level	--dB – 0dB – +24dB	(0 – 127)	45

13 – 16: Same as the parameters shaded in gray in CROSS DELAY on page 150.

[3] DYNAMIC FILTER

No.	Parameter	Range	Value	Tbl No.
1	Filter Type	LPF (12dB), LPF (18dB), LPF (24dB), HPF, BPF, BEF	(0 – 5)	
2	Sensitivity	0 – 127	(0 – 127)	
3	Dyna Level Offset	0 – 127	(0 – 127)	
4	Resonance	-16 – +111	(0 – 127)	
5	Attack Time	0.3ms – 227ms	(0 – 127)	15
6	Release Time	2.6ms – 2171ms	(0 – 127)	16
7	Release Curve	0 – 127	(0 – 127)	
8	Direction	up, down	(0 – 1)	
9	Dyna Threshold Level	0 – 127	(0 – 127)	
10	Dry/Wet Balance	D63>W – D=W – D<W63	(1 – 127)	
11	—			
12	Side Chain Input Level	--dB – 0dB – +24dB	(0 – 127)	45

13 – 16: Same as the parameters shaded in gray in CROSS DELAY on page 150.

[4] AUTO SYNTH

No.	Parameter	Range	Value	Tbl No.
1	Mod Speed	0 – 127	(0 – 127)	
2	Mod Wave Type	TypeA, TypeB, TypeC, TypeD	(0 – 3)	
3	Mod Depth	0 – 127	(0 – 127)	
4	Mod Depth Offset R	-63 – +63	(1 – 127)	
5	HPF Cutoff Frequency	20Hz – 8.0kHz	(0 – 52)	3
6	LPF Cutoff Frequency	1.0kHz – 20.0kHz	(34 – 60)	3
7	Delay Time	0.1ms – 370.0ms	(1 – 3700)	
8	Delay Time Offset R	0 – 884	(0 – 884)	
9	Delay Level	0 – 127	(0 – 127)	
10	Dry Mix Level	0 – 127	(0 – 127)	
11	Feedback Level	-63 – +63	(1 – 127)	
12	FB Level Offset R	-63 – +63	(1 – 127)	
13	AM Speed	0.00Hz – 39.7Hz	(0 – 127)	1
14	AM Wave	Tri, Sine, Saw Up, Saw Down	(0 – 3)	
15	AM Depth	0 – 127	(0 – 127)	
16	AM Inverse R	Normal, Inverse	(0 – 1)	

[5] SPIRALIZER P
[7] SPIRALIZER F

No.	Parameter	Range	Value	Tbl No.
1	Spiral Speed	-39.7Hz – 0.00Hz – +39.7Hz	(1 – 255)	60
2	Filter Offset	C-2 – G8	(0 – 127)	
3	Feedback	0 – 127	(0 – 127)	
4	Spiral Step Mode	Continuous, Semitone, Scale	(0 – 2)	
5	Spiral Step Semitones	1 semitones – 12 semitones	(0 – 11)	
6	Spiral Step Scale Type	Maj, Min (Natural), Min (Harmonic)	(0 – 2)	
7	Spiral Sync	Step, Octave	(0 – 1)	
8	Offset Transition Rate	1 – 62	(1 – 62)	61
9	Spiral Step Transition Rate	1/48 – 1/2	(0 – 14)	
10	Dry/Wet Balance	D63>W – D=W – D<W63	(1 – 127)	
11				
12				
13				
14				
15				
16	Spiral Switch	Off, On	(0 – 1)	

[6] TEMPO SPIRALIZER P
[8] TEMPO SPIRALIZER F

No.	Parameter	Range	Value	Tbl No.
1	Spiral Speed	32nd/3 – 4thx6	(0 – 19)	13
2	Filter Offset	C-2 – G8	(0 – 127)	
3	Feedback	0 – 127	(0 – 127)	
4	Spiral Step Mode	Continuous, Semitone, Scale	(0 – 2)	
5	Spiral Step Semitones	1 semitones – 12 semitones	(0 – 11)	
6	Spiral Step Scale Type	Maj, Min (Natural), Min (Harmonic)	(0 – 2)	
7	Spiral Sync	Step, Octave	(0 – 1)	
8	Offset Transition Rate	1 – 62	(1 – 62)	61
9	Spiral Step Transition Rate	1/48 – 1/2	(0 – 14)	
10	Dry/Wet Balance	D63>W – D=W – D<W63	(1 – 127)	
11				
12				
13				
14				
15	Direction	Up, Down	(0 – 1)	
16	Spiral Switch	Off, On	(0 – 1)	

[9] ISOLATOR

No.	Parameter	Range	Value	Tbl No.
1	On/Off Switch	On, Off	(0 – 1)	
2	Low Level	-64 – +63	(0 – 127)	
3	Mid Level	-64 – +63	(0 – 127)	
4	High Level	-64 – +63	(0 – 127)	
5	Low Mute	Off, On	(0 – 1)	
6	Mid Mute	Off, On	(0 – 1)	
7	High Mute	Off, On	(0 – 1)	
8	—			
9	—			
10	—			
11	—			
12	—			
13	—			
14	—			
15	—			
16	—			

[10] SLICE

No.	Parameter	Range	Value	Tbl No.
1	Divide Type	16th – 4th	(5 – 11)	13
2	Gate Time	0 – 100%	(0 – 100)	
3	Pan AEG Type	A – E	(0 – 4)	
4	Pan AEG Min Level	0 – 127	(0 – 127)	
5	Pan Depth	-63 – +63	(1 – 127)	
6	Divide Min Level	0 – 127	(0 – 127)	
7	Pan Type	A – J	(0 – 9)	
8	Drive	0 – 127	(0 – 127)	
9	AEG Phase	0 – 15 (x 16th note)	(0 – 15)	
10	Dry/Wet Balance	D63>W – D=W – D<W63	(1 – 127)	
11	Phase Reset	Off (free run), Key On Reset, SEQ Start Reset	(0 – 2)	
12	Set Slice Tempo	—	—	

13 – 16: Same as the parameters shaded in gray in CROSS DELAY on page 150.

[11] TECH MODULATION

No.	Parameter	Range	Value	Tbl No.
1	Mod Speed	0 – 127	(0 – 127)	
2	Mod Depth	0 – 127	(0 – 127)	
3	Mod Gain	-12 – +12dB	(52 – 76)	
4	Mod Mix Balance	D63>W – D=W – D<W63	(1 – 127)	
5	Pre Mod HPF Cutoff Frequency	20Hz – 8.0kHz	(0 – 52)	
6	Mod LPF Cutoff Frequency	1.0kHz – 20.0kHz	(34 – 60)	
7	Mod LPF Resonance	1.0 – 12.0	(10 – 120)	
8	Delay Time	0.1 – 740.0ms	(1 – 7400)	
9	Delay Time Offset R	0 – 884	(0 – 884)	
10	Dry/Wet Balance	D63>W – D=W – D<W63	(1 – 127)	
11	Feedback Level	-63 – +63	(1 – 127)	
12	FB Level Offset R	-63 – +63	(1 – 127)	
13	Feedback Hi Damp	0.1 – 1.0	(1 – 10)	
14	FB Hi Damp Offset R	-0.9 – +0.9	(1 – 19)	
15	—			
16	—			

[12] CONTROL FILTER

No.	Parameter	Range	Value	Tbl No.
1	Filter Type	LPF (12dB), LPF (18dB), LPF (24dB), HPF, BPF	(0 – 4)	
2	Cutoff Frequency Control	0 – 127	(0 – 127)	
3	Resonance	0 – 127	(0 – 127)	
4	Filter Output Level	-12dB – +12dB	(52 – 76)	
5	—			
6	—			
7	—			
8	—			
9	—			
10	Dry/Wet Balance	D63>W – D=W – D<W63	(1 – 127)	
11	—			
12	—			
13	—			
14	—			
15	—			
16	—			

[13] VINYL BREAK

No.	Parameter	Range	Value	Tbl No.
1	Break	Off, On	(0 – 1)	
2	Speed	Fast, Middle, Slow, Vinyl Stop, Power Off	(0 – 4)	
3	Speed Adjust	+30% – -30%	(0 – 120)	
4	—			
5	—			
6	—			
7	—			
8	—			
9	—			
10	Dry/Wet Balance	D63>W – D=W – D<W63	(1 – 127)	
11	Output Level	-19.5dB – +12dB	(1 – 127)	
12	—			
13	—			
14	—			
15	—			
16	—			

[14] BEAT REPEAT EVEN
[15] BEAT REPEAT TRIPLET
[16] BEAT REPEAT EVEN+TRIPLET
[17] BEAT REPEAT FREE

No.	Parameter	Range	Value	Tbl No.
1	Repeat	Off, On	(0 - 1)	
2	Length	Even, Triplet, Even+Triplet: 1/256 - 1/1 Free: 1/256.00 - 1/1.00	Even: (0 - 8) Triplet: (0 - 8) Even+Triplet: (0 - 16) Free: (0 - 127)	48
3	Freeze	Off, On	(0 - 1)	
4	Gate Time	0 - 100%	(0 - 100)	
5	Attack Time	0 - 100%	(0 - 100)	
6	Release Time	0 - 100%	(0 - 100)	
7	Play Speed	-1.0 - +1.0	(1 - 127)	
8	Pitch Sweep	-63 - +63	(1 - 127)	
9	Time Sweep	-63 - +63	(1 - 127)	
10	Dry/Wet Balance	D63>W - D=W - D<W63	(1 - 127)	
11	Filter Type	Thru, LPF, HPF	(0 - 2)	
12	Cutoff	14.1Hz - 21.1kHz	(0 - 127)	46
13	Resonance	0.0 - 12.7	(0 - 127)	
14	Output Level	-19.5dB - +12dB	(1 - 127)	47
15	Random	Off, On	(0 - 1)	
16	Retrigger Cycle	1Beat, 1/2Beat, 1/4Beat	(0 - 2)	
17	Retrigger Gate Time	0 - 100%	(0 - 100)	
18	Retrigger Attack Time	0 - 100%	(0 - 100)	
19	Retrigger Release Time	0 - 100%	(0 - 100)	
20	Retrigger Quantize	Off, On	(0 - 1)	
21	Length Change Quantize	1Beat, 1/2Beat, 1/4Beat, 1/8Beat, Off	(0 - 4)	

Category — MISC

[1] VCM EQ 501

No.	Parameter	Range	Value	Tbl No.
1	EQ1 (LSH) Frequency	31.5Hz - 2.0kHz	(12 - 84)	28
2	EQ1 (LSH) Gain	-12.0dB - +12.0dB	(60 - 300)	
3	EQ2 Q	0.50 - 16.00	(0 - 60)	29
4	EQ2 Frequency	50.0 Hz - 20.0kHz	(20 - 124)	28
5	EQ2 Gain	-18.0dB - +18.0dB	(0 - 360)	
6	EQ3 Q	0.50 - 16.00	(0 - 60)	29
7	EQ3 Frequency	50.0Hz - 20.0kHz	(20 - 124)	28
8	EQ3 Gain	-18.0dB - +18.0dB	(0 - 360)	
9	EQ4 Q	0.50 - 16.00	(0 - 60)	29
10	EQ4 Frequency	50.0Hz - 20.0kHz	(20 - 124)	28
11	EQ4 Gain	-18.0dB - +18.0dB	(0 - 360)	
12	EQ5 (HSH) Frequency	500Hz - 20.0kHz	(60 - 124)	28
13	EQ5 (HSH) Gain	-12.0dB - +12.0dB	(60 - 300)	
14	Output Level	-12.0dB - +12.0dB	(60 - 300)	
15	—			
16	—			

[2] PRESENCE

No.	Parameter	Range	Value	Tbl No.
1	Presence	0 - 100	(0 - 100)	
2	Texture	0 - 100	(0 - 100)	
3	Output Level	-6dB - +6dB	(0 - 120)	
4	—			
5	—			
6	—			
7	—			
8	—			
9	—			
10	—			
11	—			
12	—			
13	—			
14	—			
15	—			
16	—			

[3] HARMONIC ENHANCER

No.	Parameter	Range	Value	Tbl No.
1	HPF Cutoff Frequency	500Hz - 16.0kHz	(28 - 58)	3
2	Drive	0 - 127	(0 - 127)	
3	Mix Level	0 - 127	(0 - 127)	
4	—			
5	—			
6	—			
7	—			
8	—			
9	—			
10	—			
11	—			
12	—			
13	—			
14	—			
15	—			
16	—			

[4] STEREOPHONIC OPTIMIZER

No.	Parameter	Range	Value	Tbl No.
1	Low Subband Gain Lch	-14.00dB - 6.00dB	(5801 - 7801)	
2	Low Subband Gain Rch	-14.00dB - 6.00dB	(5801 - 7801)	
3	Mid1 Subband Gain Lch	-14.00dB - 6.00dB	(5801 - 7801)	
4	Mid1 Subband Gain Rch	-14.00dB - 6.00dB	(5801 - 7801)	
5	Mid2 Subband Gain Lch	-14.00dB - 6.00dB	(5801 - 7801)	
6	Mid2 Subband Gain Rch	-14.00dB - 6.00dB	(5801 - 7801)	
7	Mid3 Subband Gain Lch	-14.00dB - 6.00dB	(5801 - 7801)	
8	Mid3 Subband Gain Rch	-14.00dB - 6.00dB	(5801 - 7801)	
9	High Subband Gain Lch	-14.00dB - 6.00dB	(5801 - 7801)	
10	High Subband Gain Rch	-14.00dB - 6.00dB	(5801 - 7801)	
11	Width Low	0.00 - 1.00	(0 - 100)	
12	Width Mid1	0.00 - 1.00	(0 - 100)	
13	Width Mid2	0.00 - 1.00	(0 - 100)	
14	Width Mid3	0.00 - 1.00	(0 - 100)	
15	Width High	0.00 - 1.00	(0 - 100)	
16	On/Off Switch	Off, On	(0 - 1)	

[5] TALKING MODULATOR

No.	Parameter	Range	Value	Tbl No.
1	Vowel	a, i, u, e, o	(0 - 4)	
2	Move Speed	1 - 62	(1 - 62)	
3	Drive	0 - 127	(0 - 127)	
4	Output Level	0 - 127	(0 - 127)	
5	—			
6	—			
7	—			
8	—			
9	—			
10	—			
11	—			
12	—			
13	—			
14	—			
15	—			
16	—			

[6] DAMPER RESONANCE

No.	Parameter	Range	Value	Tbl No.
1	—			
2	—			
3	—			
4	—			
5	—			
6	—			
7	—			
8	—			
9	—			
10	Dry/Wet Balance	D63>W - D=W - D<W63	(1 - 127)	
11	—			
12	—			
13	—			
14	—			
15	—			
16	Damper Control	0 - 127	(0 - 127)	

[7] PITCH CHANGE

No.	Parameter	Range	Value	Tbl No.
1	Pitch 1	-24 – +24	(40 – 88)	
2	Fine 1	-50 – +50	(14 – 114)	
3	Initial Delay 1	0.1ms – 400.0ms	(0 – 127)	7
4	Feedback Level 1	-63 – +63	(1 – 127)	
5	Pitch 2	-24 – +24	(40 – 88)	
6	Fine 2	-50 – +50	(14 – 114)	
7	Initial Delay 2	0.1ms – 400.0ms	(0 – 127)	7
8	Feedback Level 2	-63 – +63	(1 – 127)	
9	—			
10	Dry/Wet Balance	D63>W – D=W – D<W63	(1 – 127)	
11	Pan 1	L63 – C – R63	(1 – 127)	
12	Output Level 1	0 – 127	(0 – 127)	
13	Pan 2	L63 – C – R63	(1 – 127)	
14	Output Level 2	0 – 127	(0 – 127)	
15	—			
16	—			

[8] EARLY REFLECTION

No.	Parameter	Range	Value	Tbl No.
1	Type	S-hall, L-hall, Random, Reverse, Plate, Spring	(0 – 5)	
2	Room Size	0.1 – 20.0 0.1 – 7.0 (Ins17)	(0 – 127) (0 – 44)	6
3	Diffusion	0 – 10	(0 – 10)	
4	Initial Delay	0.1ms – 200.0ms 0.1ms – 99.3ms (Ins17)	(0 – 127) (0 – 63)	5
5	Feedback Level	-63 – +63	(1 – 127)	
6	HPF Cutoff Frequency	20Hz – 8.0kHz	(0 – 52)	3
7	LPF Cutoff Frequency	1.0kHz – 20.0kHz	(34 – 60)	3
8	—			
9	—			
10	Dry/Wet Balance	D63>W – D=W – D<W63	(1 – 127)	
11	Liveness	0 – 10	(0 – 10)	
12	Density	0 – 3	(0 – 3)	
13	Feedback High Damp	0.1 – 1.0	(1 – 10)	
14	—			
15	—			
16	—			

[9] VOCODER

No.	Parameter	Range	Value	Tbl No.
1	Formant Shift	-2, -1, 0, +1, +2	(62 – 66)	
2	Formant Offset	-63 – +63	(1 – 127)	
3	Vocoder Attack	1ms – 200ms	(0 – 29)	
4	Vocoder Release	10ms – 3000ms	(0 – 23)	
5	Mic Output Gate Switch	Off, On	(0 – 1)	
6	—			
7	HPF Cutoff Frequency	Thru, 500Hz – 16.0kHz	(27 – 58)	
8	HPF Output Level	0 – 127	(0 – 127)	
9	—			
10	Dry/Wet Balance	D63>W – D=W – D<W63	(1 – 127)	
11	Mic Input Level	--dB – 0dB – +24dB	(0 – 127)	45
12	Inst Level	0 – 127	(0 – 127)	
13	Noise Level	0 – 127	(0 – 127)	
14	Output Level	0 – 127	(0 – 127)	
15	BPF1 Gain	-18dB – +18dB	(46 – 82)	
16	BPF2 Gain	-18dB – +18dB	(46 – 82)	
17	BPF3 Gain	-18dB – +18dB	(46 – 82)	
18	BPF4 Gain	-18dB – +18dB	(46 – 82)	
19	BPF5 Gain	-18dB – +18dB	(46 – 82)	
20	BPF6 Gain	-18dB – +18dB	(46 – 82)	
21	BPF7 Gain	-18dB – +18dB	(46 – 82)	
22	BPF8 Gain	-18dB – +18dB	(46 – 82)	
23	BPF9 Gain	-18dB – +18dB	(46 – 82)	
24	BPF10 Gain	-18dB – +18dB	(46 – 82)	

[10] NOISE GATE+COMP+EQ

No.	Parameter	Range	Value	Tbl No.
1	Comp Attack	1ms – 40ms	(0 – 19)	8
2	Comp Release	10ms – 680ms	(0 – 15)	9
3	Comp Threshold	-48dB – -6dB	(79 – 121)	
4	Comp Ratio	1.0 – 20.0	(0 – 7)	10
5	Comp Output Level	0 – 127	(0 – 127)	
6 – 9	Same as the parameters shaded in gray in CROSS DELAY on page 150.			
10	—			
11	Noise Gate Attack	1ms – 40ms	(0 – 19)	
12	Noise Gate Release	10ms – 680ms	(0 – 15)	

No.	Parameter	Range	Value	Tbl No.
13	Noise Gate Threshold	-73dB – -30dB	(54 – 97)	
14	EQ Mid Frequency	100Hz – 10.0kHz	(14 – 54)	3
15	EQ Mid Gain	-12dB – +12dB	(52 – 76)	
16	EQ Mid Width	0.1 – 12.0	(1 – 120)	

EQ Block

[0] EQ

No.	Parameter	Range	Value	Tbl No.
1	EQ1 Type	Thru, LPF (-6dB/oct), HPF (-6dB/oct), Low Shelving, Hi Shelving, Peak/Dip	0 – 5	
2	EQ1 Freq	63Hz – 18.0Hz	48 – 244	39
3	EQ1 Gain	-12dB – 0 – +12dB	40 – 64 – 88	
4	EQ1 Q	0.1 – 12.0	1 – 120	
5	EQ2 Type	Thru, LPF (-6dB/oct), HPF (-6dB/oct), Low Shelving, Hi Shelving, Peak/Dip	0 – 5	
6	EQ2 Freq	63Hz – 18.0Hz	48 – 244	39
7	EQ2 Gain	-12dB – 0 – +12dB	40 – 64 – 88	
8	EQ2 Q	0.1 – 12.0	1 – 120	
9	Output Gain	-12dB – 0 – +12dB	40 – 64 – 88	

Master Effect Block

THRU type is not included in the Master Effect Block. If you wish to bypass this block, turn the Master Effect off.

- DELAY LR**
- COMP DISTORTION DELAY**
- VCM COMPRESSOR 376**
- MULTI BAND COMP**
- UNIVERSAL COMPRESSOR DOWN**
- UNIVERSAL COMPRESSOR UP**
- PRESENCE**
- PARALLEL COMPRESSOR**
- LO-FI**
- BIT CRUSHER**
- RING MODULATOR**
- DYNAMIC FILTER**
- SPIRALIZER P**
- TEMPO SPIRALIZER P**
- SPIRALIZER TYPE F**
- TEMPO SPIRALIZER F**
- ISOLATOR**
- SLICE**
- VINYL BREAK**
- BEAT REPEAT EVEN**
- BEAT REPEAT TRIPLET**
- BEAT REPEAT EVEN+TRIPLET**
- BEAT REPEAT FREE**

Master EQ Block

[0] MEQ

No.	Parameter	Range	Value	Tbl No.
1	EQ1 Gain	-12dB – +12dB	(52 – 76)	
2	EQ1 Frequency	32Hz – 2.0kHz	(4 – 40)	3
3	EQ1 Q	0.1 – 12.0	(1 – 120)	
4	EQ1 Shape	Shelving, Peaking	(0 – 1)	
5	EQ2 Gain	-12dB – +12dB	(52 – 76)	
6	EQ2 Frequency	100Hz – 10kHz	(14 – 54)	3
7	EQ2 Q	0.1 – 12.0	(1 – 120)	
8	—			
9	EQ3 Gain	-12dB – +12dB	(52 – 76)	
10	EQ3 Frequency	100Hz – 10kHz	(14 – 54)	3
11	EQ3 Q	0.1 – 12.0	(1 – 120)	
12	—			
13	EQ4 Gain	-12dB – +12dB	(52 – 76)	
14	EQ4 Frequency	100Hz – 10kHz	(14 – 54)	3
15	EQ4 Q	0.1 – 12.0	(1 – 120)	
16	—			
17	EQ5 Gain	-12dB – +12dB	(52 – 76)	
18	EQ5 Frequency	500Hz – 16kHz	(28 – 58)	3
19	EQ5 Q	0.1 – 12.0	(1 – 120)	
20	EQ5 Shape	Shelving, Peaking	(0 – 1)	

Effect Preset List

Category	Effect Type Name	Preset Name
Reverb	HD Hall	Large Hall Medium Hall Bright Hall
	REV-X Hall	Basic Small Hall Clean Church Bright Hall
	R3 Hall	Basic Large Hall Backstage Ballad Light
	SPX Hall	Basic Large Hall Backstage Light Gymnasium
	HD Room	Room Power Room
	REV-X Room	Basic Basement Garage Bedroom
	R3 Room	Basic Open Wide Tight
	SPX Room	Basic Open Wide Tight
	HD Plate	Large Plate Medium Plate Rattle Plate
	R3 Plate	Basic Bright Vocal Smooth Vocal Short Bright Metal Splash
	SPX Stage	Basic Small Large
	Space Simulator	Tunnel Basement Canyon White Room Small Room Live Room Three Walls
	Gated Reverb	Gated Reverb 1 Gated Reverb 2
Reverse Reverb	Basic	
Delay	Cross Delay	Basic Short Long Very Long
	Tempo Cross Delay	1/4 Echo Dotted 1/8 Echo 1/8 Echo Triplet Echo 1/2 Echo
	Tempo Delay Mono	1/4 Echo 1/4 Mono Dotted 1/8 Echo 1/8 Echo Dotted 1/8 Mono 1/8 Mono Triplet Echo Triplet Mono Analog Delay
	Tempo Delay Stereo	1/4 Echo Dotted 1/8 Echo 1/8 Echo Triplet Echo
	Control Delay	Basic
	Delay LR	Basic Doubling Short Fast Long Very Long Analog Delay
	Delay LCR	Bounce Analog Delay

Category	Effect Type Name	Preset Name
Delay	Analog Delay Retro	Mellow Magical Dawn Reel to Reel Bright Dub Magical Dub Deep Lo-Fi Echo Oil Dark Room Smokey Dub
	Analog Delay Modern	Urban Soft Rock Reel to Reel Dub Long Bucket Rev Clear Black Dub Short Lo-Fi Echo Dark Room New Wave
Chorus	G Chorus	Basic Fast Deep Mist Bright
	2 Modulator	Basic Fast Deep Mist Multi Panning Mod Vibrator Wonder Shimmer
	SPX Chorus	Basic Fast Deep Slow Flangy
	Symphonic	Basic Fast Deep Slow Analog
	Ensemble Detune	Basic Soft Wide Deep Wide Stereo Sim
Flanger	VCM Flanger	Basic Deep Mod 1 Deep Mod 2 Mad Mod
	Classic Flanger	Basic Flange Chorus Psychedelic Jet
	Tempo Flanger	Deep Mod Flange Chorus Metallic Psychedelic Jet
	Dynamic Flanger	Follow Reverse Distorted Sync
	Control Flanger	Basic
Phaser	VCM Phaser Mono	E.Piano Orange 90 Two Phase Deep Six Deep Eight Lite Eight Deep Sweeper Orange 100 Red Twelve Blue Sixteen Clavi 1 Clavi 2 E.Guitar 1 E.Guitar 2 E.Guitar 3 Vibrato 1 Vibrato 2 Vibrato 3 Ambience 1 Ambience 2

Category	Effect Type Name	Preset Name
Phaser	VCM Phaser Stereo	Deep Sweeper E.Piano 1 E.Piano 2 Clavi 1 Clavi 2 E.Guitar 1 E.Guitar 2 E.Guitar 3 Deep Six Deep Eight Vibrato 1 Vibrato 2 Vibrato 3 Ambience 1 Ambience 2
	Tempo Phaser	Basic Deep Phase
	Dynamic Phaser	Follow Reverse Light
	Control Phaser	Basic
Tremolo&Rotary	Auto Pan	E.Piano Smooth Oval Right Turn Super Slow
	Tremolo	Fast Slow Super Fast Stereo Vibrato Spring Relax
	Rotary Speaker 1	Basic Horn Mic Light Heavy Rotor Fast First
	Rotary Speaker 2	Clean and Wide Vintage Mono Slow and Dirty Full Drive Broken Motors
Distortion	Amp Simulator 1	Stack 1 Stack 2 Twin Boost Old Amp Transistor Modern US-Clean J-Clean Fuzz Small Blues Buzzy Bottom Beat Crunch Beat Drive
	Amp Simulator 2	Stack 1 Stack 2 Combo Crunch Hi Gain British Tube Drive Tube Clean
	Comp Distortion	Basic Booster School Boy Detroit Long Lead 80s Clean
	Comp Distortion Delay	Hard 1 Hard 2 Grunge Voodoo Texas Rockabilly LA Session Thin Techno
	U.S. Combo	Twin Rich Clean Thin Clean Crunch
	Jazz Combo	Basic Warm Chorus
	U.S. High Gain	Dirty Riff Burn Solo

Category	Effect Type Name	Preset Name
Distortion	British Lead	Dirty Drive Gainer Hard
	Multi FX	Distortion Solo Distortion Basic Overdrive Chorus Crunch Wah Oldies Delay Vintage Echo
	Small Stereo	Distortion Overdrive Vintage Amp Heavy Dist
	British Combo	Classic Top Boost Custom Heavy
	British Legend	Blues Heavy 1 Heavy 2 Clean Dirty Clean
Compressor	VCM Compressor 376	Basic Comp Sustainer 60s Drum Kit Natural Kick Old Piano Valve Tone Bass Hard Basic Fast Atk + Boost Soft Atk + Boost Attack & Tight Hard Atk + Boost Vocal Comp 117x Unplugged Attack Comp Punchy Master Pinched
	Classic Compressor	Basic Attack For Vintage Keys Pack Comp Gate TightPopRhythm Cutting Comp Basic Bass Old Record Piano
	Multi-band Comp	Basic Maximizer Wild Attacky Hard Hip Club Slap Bass (ch)
	Uni Comp Down	Basic Warm Bright Comp + Hard Clip
	Uni Comp Up	Basic Warm Bright Comp + Hard Clip
	Parallel Comp	Natural Rich Punchy Electronic Loud
Wah	VCM Auto Wah	Low High For Bass
	VCM Touch Wah	Follow Hi Q For Bass Reverse
	VCM Pedal Wah	Low High

Category	Effect Type Name	Preset Name
Lo-Fi	Lo-Fi	Lo-Fi Old Phone Overload Max Lo-Fi
	Noisy	Noisy Tremolo Noise Fuzz Noise
	Digital Turntable	Old Record 1 Old Record 2 Short Wave Radio
	Bit Crusher	Hard Soft 12-bit Sampler Mid-Side 1 Mid-Side 2 Mid-Side 3 2-bit Dist
Tech	Ring Modulator	Basic Slow Tremolo Crazy
	Dynamic Ring Modulator	Basic Metallic Sputter Sharp Edge
	Dynamic Filter	Basic High Pass Low Pass Squish
	Auto Synth	Echo Space Walking Robot Delay
	Spiralizer P	Basic Step1 Scale Step2 Slow
	Tempo Spiralizer P	Basic Step1 Scale Step2 Slow
	Spiralizer F	Basic Step1 Scale Step2 Slow
	Tempo Spiralizer F	Basic Step1 Scale Step2 Slow
	Isolator	Mid Only Near Flat
	Slice	Slice Beat 8th Pan 16th Mute Rock
	Tech Modulation	Star Train Numerator Active Dist Astonish Drift Armor
	Control Filter	HPF LPF BPF
	Vinyl Break	Fast Middle Slow Vinyl Stop Power Off
	Beat Repeat (even)	1/16 x 4 1/16 x 4 Rev. Trans Gate Trans Gate + HPF Pitch Sweep PitchSweep+HPF Slow Attack Echo Broken

Category	Effect Type Name	Preset Name
Tech	Beat Repeat (triplet)	Triplet x 4 Triplet x 4 Rev. Trans Gate Trans Gate + HPF Pitch Sweep PitchSweep+HPF Slow Attack Echo Broken
	Beat Repeat (evn+tri.)	1/16 x 4 1/16 x 4 Rev. Trans Gate Trans Gate + HPF Pitch Sweep PitchSweep+HPF Slow Attack Echo Broken
	Beat Repeat (free)	1/16 x 4 1/16 x 4 Rev. Trans Gate Trans Gate + HPF Pitch Sweep PitchSweep+HPF Slow Atk Echo Broken Quintuplet
Misc	VCM EQ 501	Flat Radio Speaker Dance SD/BD
	Presence	Natural Heavy Bright
	Harmonic Enhancer	Edge High Edge Mid Edge
	Stereophonic Optimizer	Acoustic Piano Drum EP Tremolo Organ Sax
	Talking Modulator	Basic
	Damper Resonance	Basic
	Pitch Change	Detune Oct Echo Octaver Plus 4th Minus 4th Oval Step Up Step Down
	Early Reflection	Close Far Reverse Gate 70s Gate
	Vocoder	Basic
	NoiseGate + Comp + Eq	Basic

Effect Data Assign Table

Table #1
LFO Frequency

Data	Value	Data	Value
0	0.00	64	2.69
1	0.04	65	2.78
2	0.08	66	2.86
3	0.13	67	2.94
4	0.17	68	3.03
5	0.21	69	3.11
6	0.25	70	3.20
7	0.29	71	3.28
8	0.34	72	3.37
9	0.38	73	3.45
10	0.42	74	3.53
11	0.46	75	3.62
12	0.51	76	3.70
13	0.55	77	3.87
14	0.59	78	4.04
15	0.63	79	4.21
16	0.67	80	4.37
17	0.72	81	4.54
18	0.76	82	4.71
19	0.80	83	4.88
20	0.84	84	5.05
21	0.88	85	5.22
22	0.93	86	5.38
23	0.97	87	5.55
24	1.01	88	5.72
25	1.05	89	6.06
26	1.09	90	6.39
27	1.14	91	6.73
28	1.18	92	7.07
29	1.22	93	7.40
30	1.26	94	7.74
31	1.30	95	8.08
32	1.35	96	8.41
33	1.39	97	8.75
34	1.43	98	9.08
35	1.47	99	9.42
36	1.51	100	9.76
37	1.56	101	10.1
38	1.60	102	10.8
39	1.64	103	11.4
40	1.68	104	12.1
41	1.72	105	12.8
42	1.77	106	13.5
43	1.81	107	14.1
44	1.85	108	14.8
45	1.89	109	15.5
46	1.94	110	16.2
47	1.98	111	16.8
48	2.02	112	17.5
49	2.06	113	18.2
50	2.10	114	19.5
51	2.15	115	20.9
52	2.19	116	22.2
53	2.23	117	23.6
54	2.27	118	24.9
55	2.31	119	26.2
56	2.36	120	27.6
57	2.40	121	28.9
58	2.44	122	30.3
59	2.48	123	31.6
60	2.52	124	33.0
61	2.57	125	34.3
62	2.61	126	37.0
63	2.65	127	39.7

Table #2
Modulation Delay Offset

Data	Value	Data	Value
0	0.0	64	6.4
1	0.1	65	6.5
2	0.2	66	6.6
3	0.3	67	6.7
4	0.4	68	6.8
5	0.5	69	6.9
6	0.6	70	7.0
7	0.7	71	7.1
8	0.8	72	7.2
9	0.9	73	7.3
10	1.0	74	7.4
11	1.1	75	7.5
12	1.2	76	7.6
13	1.3	77	7.7
14	1.4	78	7.8
15	1.5	79	7.9
16	1.6	80	8.0
17	1.7	81	8.1
18	1.8	82	8.2
19	1.9	83	8.3
20	2.0	84	8.4
21	2.1	85	8.5
22	2.2	86	8.6
23	2.3	87	8.7
24	2.4	88	8.8
25	2.5	89	8.9
26	2.6	90	9.0
27	2.7	91	9.1
28	2.8	92	9.2
29	2.9	93	9.3
30	3.0	94	9.4
31	3.1	95	9.5
32	3.2	96	9.6
33	3.3	97	9.7
34	3.4	98	9.8
35	3.5	99	9.9
36	3.6	100	10.0
37	3.7	101	11.1
38	3.8	102	12.2
39	3.9	103	13.3
40	4.0	104	14.4
41	4.1	105	15.5
42	4.2	106	17.1
43	4.3	107	18.6
44	4.4	108	20.2
45	4.5	109	21.8
46	4.6	110	23.3
47	4.7	111	24.9
48	4.8	112	26.5
49	4.9	113	28.0
50	5.0	114	29.6
51	5.1	115	31.2
52	5.2	116	32.8
53	5.3	117	34.3
54	5.4	118	35.9
55	5.5	119	37.5
56	5.6	120	39.0
57	5.7	121	40.6
58	5.8	122	42.2
59	5.9	123	43.7
60	6.0	124	45.3
61	6.1	125	46.9
62	6.2	126	48.4
63	6.3	127	50.0

Table #3
EQ Frequency

Data	Value
0	THRU (20)
1	22
2	25
3	28
4	32
5	36
6	40
7	45
8	50
9	56
10	63
11	70
12	80
13	90
14	100
15	110
16	125
17	140
18	160
19	180
20	200
21	225
22	250
23	280
24	315
25	355
26	400
27	450
28	500
29	560
30	630
31	700
32	800
33	900
34	1.0k
35	1.1k
36	1.2k
37	1.4k
38	1.6k
39	1.8k
40	2.0k
41	2.2k
42	2.5k
43	2.8k
44	3.2k
45	3.6k
46	4.0k
47	4.5k
48	5.0k
49	5.6k
50	6.3k
51	7.0k
52	8.0k
53	9.0k
54	10.0k
55	11.0k
56	12.0k
57	14.0k
58	16.0k
59	18.0k
60	THRU (20.0k)

Table #4
Reverb Time

Data	Value
0	0.3
1	0.4
2	0.5
3	0.6
4	0.7
5	0.8
6	0.9
7	1.0
8	1.1
9	1.2
10	1.3
11	1.4
12	1.5
13	1.6
14	1.7
15	1.8
16	1.9
17	2.0
18	2.1
19	2.2
20	2.3
21	2.4
22	2.5
23	2.6
24	2.7
25	2.8
26	2.9
27	3.0
28	3.1
29	3.2
30	3.3
31	3.4
32	3.5
33	3.6
34	3.7
35	3.8
36	3.9
37	4.0
38	4.1
39	4.2
40	4.3
41	4.4
42	4.5
43	4.6
44	4.7
45	4.8
46	4.9
47	5.0
48	5.5
49	6.0
50	6.5
51	7.0
52	7.5
53	8.0
54	8.5
55	9.0
56	9.5
57	10.0
58	11.0
59	12.0
60	13.0
61	14.0
62	15.0
63	16.0
64	17.0
65	18.0
66	19.0
67	20.0
68	25.0
69	30.0

Table #5
Delay Time (0.1 – 200.0 [ms])

Data	Value	Data	Value
0	0.1	64	100.8
1	1.7	65	102.4
2	3.2	66	104.0
3	4.8	67	105.6
4	6.4	68	107.1
5	8.0	69	108.7
6	9.5	70	110.3
7	11.1	71	111.9
8	12.7	72	113.4
9	14.3	73	115.0
10	15.8	74	116.6
11	17.4	75	118.2
12	19.0	76	119.7
13	20.6	77	121.3
14	22.1	78	122.9
15	23.7	79	124.4
16	25.3	80	126.0
17	26.9	81	127.6
18	28.4	82	129.2
19	30.0	83	130.7
20	31.6	84	132.3
21	33.2	85	133.9
22	34.7	86	135.5
23	36.3	87	137.0
24	37.9	88	138.6
25	39.5	89	140.2
26	41.0	90	141.8
27	42.6	91	143.3
28	44.2	92	144.9
29	45.7	93	146.5
30	47.3	94	148.1
31	48.9	95	149.6
32	50.5	96	151.2
33	52.0	97	152.8
34	53.6	98	154.4
35	55.2	99	155.9
36	56.8	100	157.5
37	58.3	101	159.1
38	59.9	102	160.6
39	61.5	103	162.2
40	63.1	104	163.8
41	64.6	105	165.4
42	66.2	106	166.9
43	67.8	107	168.5
44	69.4	108	170.1
45	70.9	109	171.7
46	72.5	110	173.2
47	74.1	111	174.8
48	75.7	112	176.4
49	77.2	113	178.0
50	78.8	114	179.5
51	80.4	115	181.1
52	81.9	116	182.7
53	83.5	117	184.3
54	85.1	118	185.8
55	86.7	119	187.4
56	88.2	120	189.0
57	89.8	121	190.6
58	91.4	122	192.1
59	93.0	123	193.7
60	94.5	124	195.3
61	96.1	125	196.9
62	97.7	126	198.4
63	99.3	127	200.0

Table #6
Room Size

Data	Value	Data	Value
0	0.1	64	10.1
1	0.3	65	10.3
2	0.4	66	10.4
3	0.6	67	10.6
4	0.7	68	10.8
5	0.9	69	10.9
6	1.0	70	11.1
7	1.2	71	11.2
8	1.4	72	11.4
9	1.5	73	11.5
10	1.7	74	11.7
11	1.8	75	11.9
12	2.0	76	12.0
13	2.1	77	12.2
14	2.3	78	12.3
15	2.5	79	12.5
16	2.6	80	12.6
17	2.8	81	12.8
18	2.9	82	12.9
19	3.1	83	13.1
20	3.2	84	13.3
21	3.4	85	13.4
22	3.5	86	13.6
23	3.7	87	13.7
24	3.9	88	13.9
25	4.0	89	14.0
26	4.2	90	14.2
27	4.3	91	14.4
28	4.5	92	14.5
29	4.6	93	14.7
30	4.8	94	14.8
31	5.0	95	15.0
32	5.1	96	15.1
33	5.3	97	15.3
34	5.4	98	15.5
35	5.6	99	15.6
36	5.7	100	15.8
37	5.9	101	15.9
38	6.1	102	16.1
39	6.2	103	16.2
40	6.4	104	16.4
41	6.5	105	16.6
42	6.7	106	16.7
43	6.8	107	16.9
44	7.0	108	17.0
45	7.2	109	17.2
46	7.3	110	17.3
47	7.5	111	17.5
48	7.6	112	17.6
49	7.8	113	17.8
50	7.9	114	18.0
51	8.1	115	18.1
52	8.2	116	18.3
53	8.4	117	18.4
54	8.6	118	18.6
55	8.7	119	18.7
56	8.9	120	18.9
57	9.0	121	19.1
58	9.2	122	19.2
59	9.3	123	19.4
60	9.5	124	19.5
61	9.7	125	19.7
62	9.8	126	19.8
63	10.0	127	20.0

Table #7
Delay Time (0.1 – 400.0 [ms])

Data	Value	Data	Value
0	0.1	64	201.6
1	3.2	65	204.8
2	6.4	66	207.9
3	9.5	67	211.1
4	12.7	68	214.2
5	15.8	69	217.4
6	19.0	70	220.5
7	22.1	71	223.7
8	25.3	72	226.8
9	28.4	73	230.0
10	31.6	74	233.1
11	34.7	75	236.3
12	37.9	76	239.4
13	41.0	77	242.6
14	44.2	78	245.7
15	47.3	79	248.9
16	50.5	80	252.0
17	53.6	81	255.2
18	56.8	82	258.3
19	59.9	83	261.5
20	63.1	84	264.6
21	66.2	85	267.7
22	69.4	86	270.9
23	72.5	87	274.0
24	75.7	88	277.2
25	78.8	89	280.3
26	82.0	90	283.5
27	85.1	91	286.6
28	88.3	92	289.8
29	91.4	93	292.9
30	94.6	94	296.1
31	97.7	95	299.2
32	100.9	96	302.4
33	104.0	97	305.5
34	107.2	98	308.7
35	110.3	99	311.8
36	113.5	100	315.0
37	116.6	101	318.1
38	119.8	102	321.3
39	122.9	103	324.4
40	126.1	104	327.6
41	129.2	105	330.7
42	132.4	106	333.9
43	135.5	107	337.0
44	138.6	108	340.2
45	141.8	109	343.3
46	144.9	110	346.5
47	148.1	111	349.6
48	151.2	112	352.8
49	154.4	113	355.9
50	157.5	114	359.1
51	160.7	115	362.2
52	163.8	116	365.4
53	167.0	117	368.5
54	170.1	118	371.7
55	173.3	119	374.8
56	176.4	120	378.0
57	179.6	121	381.1
58	182.7	122	384.3
59	185.9	123	387.4
60	189.0	124	390.6
61	192.2	125	393.7
62	195.3	126	396.9
63	198.5	127	400.0

Table #8
Compressor
Attack Time

Data	Value
0	1
1	2
2	3
3	4
4	5
5	6
6	7
7	8
8	9
9	10
10	12
11	14
12	16
13	18
14	20
15	23
16	26
17	30
18	35
19	40
20	50
21	60
22	70
23	80
24	100
25	120
26	140
27	160
28	180
29	200

Table #9
Compressor
Release Time

Data	Value
0	10
1	15
2	25
3	35
4	45
5	55
6	65
7	75
8	85
9	100
10	115
11	140
12	170
13	230
14	340
15	680
16	850
17	1000
18	1200
19	1500
20	1700
21	2000
22	2400
23	3000

Table #10
Compressor
Ratio

Data	Value
0	1.0
1	1.5
2	2.0
3	3.0
4	5.0
5	7.0
6	10.0
7	20.0

Table #11
Reverb Width; Depth; Height

Data	Value	Data	Value
0	0.5	64	17.6
1	0.8	65	17.9
2	1.0	66	18.2
3	1.3	67	18.5
4	1.5	68	18.8
5	1.8	69	19.1
6	2.0	70	19.4
7	2.3	71	19.7
8	2.6	72	20.0
9	2.8	73	20.2
10	3.1	74	20.5
11	3.3	75	20.8
12	3.6	76	21.1
13	3.9	77	21.4
14	4.1	78	21.7
15	4.4	79	22.0
16	4.6	80	22.4
17	4.9	81	22.7
18	5.2	82	23.0
19	5.4	83	23.3
20	5.7	84	23.6
21	5.9	85	23.9
22	6.2	86	24.2
23	6.5	87	24.5
24	6.7	88	24.9
25	7.0	89	25.2
26	7.2	90	25.5
27	7.5	91	25.8
28	7.8	92	26.1
29	8.0	93	26.5
30	8.3	94	26.8
31	8.6	95	27.1
32	8.8	96	27.5
33	9.1	97	27.8
34	9.4	98	28.1
35	9.6	99	28.5
36	9.9	100	28.8
37	10.2	101	29.2
38	10.4	102	29.5
39	10.7	103	29.9
40	11.0	104	30.2
41	11.2		
42	11.5		
43	11.8		
44	12.1		
45	12.3		
46	12.6		
47	12.9		
48	13.1		
49	13.4		
50	13.7		
51	14.0		
52	14.2		
53	14.5		
54	14.8		
55	15.1		
56	15.4		
57	15.6		
58	15.9		
59	16.2		
60	16.5		
61	16.8		
62	17.1		
63	17.3		

Table #12
LO-FI Sampling Frequency Control

Data	Value	Data	Value
0	44.1k	64	678.5
1	22.1k	65	668.2
2	14.7k	66	658.2
3	11.0k	67	648.5
4	8.82k	68	639.1
5	7.35k	69	630.0
6	6.30k	70	621.1
7	5.51k	71	612.5
8	4.90k	72	604.1
9	4.41k	73	595.9
10	4.01k	74	588.0
11	3.68k	75	580.3
12	3.39k	76	572.7
13	3.15k	77	565.4
14	2.94k	78	558.2
15	2.76k	79	551.3
16	2.59k	80	544.4
17	2.45k	81	537.8
18	2.32k	82	531.3
19	2.21k	83	525.0
20	2.10k	84	518.8
21	2.00k	85	512.8
22	1.92k	86	506.9
23	1.84k	87	501.1
24	1.76k	88	495.5
25	1.70k	89	490.0
26	1.63k	90	484.6
27	1.58k	91	479.3
28	1.52k	92	474.2
29	1.47k	93	469.1
30	1.42k	94	464.2
31	1.38k	95	459.4
32	1.34k	96	454.6
33	1.30k	97	450.0
34	1.26k	98	445.5
35	1.23k	99	441.0
36	1.19k	100	436.6
37	1.16k	101	432.4
38	1.13k	102	428.2
39	1.10k	103	424.0
40	1.08k	104	420.0
41	1.05k	105	416.0
42	1.03k	106	412.1
43	1.00k	107	408.3
44	980.0	108	404.6
45	958.7	109	400.9
46	938.3	110	397.3
47	918.8	111	393.8
48	900.0	112	390.3
49	882.0	113	386.8
50	864.7	114	383.5
51	848.1	115	380.2
52	832.1	116	376.9
53	816.7	117	373.7
54	801.8	118	370.6
55	787.5	119	367.5
56	773.7	120	364.5
57	760.3	121	361.5
58	747.5	122	358.5
59	735.0	123	355.6
60	723.0	124	352.8
61	711.3	125	350.0
62	700.0	126	347.2
63	689.1	127	344.5

Table #13
Tempo

Data	Value
0	32nd/3
1	64th.
2	32nd
3	16th/3
4	32nd.
5	16th
6	8th/3
7	16th.
8	8th
9	4th/3
10	8th.
11	4th
12	2nd/3
13	4th.
14	2nd
15	Whole/3
16	2nd.
17	4thX4
18	4thX5
19	4thX6
20	4thX7
21	4thX8
22	4thX9
23	4thX10
24	4thX11
25	4thX12
26	4thX13
27	4thX14
28	4thX15
29	4thX16

Table #14
Multi Compressor Gain (dB)

Data	Value	Data	Value
0	-∞	29	-8
1	-60	30	-7
2	-57	31	-6
3	-54	32	-5
4	-51	33	-4
5	-48	34	-3
6	-45	35	-2
7	-42	36	-1
8	-39	37	0
9	-36	38	1
10	-33	39	2
11	-30	40	3
12	-27	41	4
13	-24	42	5
14	-23	43	6
15	-22	44	7
16	-21	45	8
17	-20	46	9
18	-19	47	10
19	-18	48	11
20	-17	49	12
21	-16	50	13
22	-15	51	14
23	-14	52	15
24	-13	53	16
25	-12	54	17
26	-11	55	18
27	-10		
28	-9		

Table #15
Dyna Attack Time (ms)

Data	Value	Data	Value
0	0.3	64	112
1	0.9	65	114
2	1.8	66	116
3	2.7	67	118
4	3.6	68	120
5	5.4	69	121
6	7.2	70	123
7	9.0	71	125
8	10	72	127
9	12	73	129
10	14	74	130
11	16	75	132
12	18	76	134
13	20	77	136
14	21	78	138
15	23	79	140
16	25	80	141
17	27	81	143
18	29	82	145
19	30	83	147
20	32	84	149
21	34	85	150
22	36	86	152
23	38	87	154
24	40	88	156
25	41	89	158
26	43	90	160
27	45	91	161
28	47	92	163
29	49	93	165
30	50	94	167
31	52	95	169
32	54	96	170
33	56	97	172
34	58	98	174
35	60	99	176
36	61	100	178
37	63	101	180
38	65	102	181
39	67	103	183
40	69	104	185
41	70	105	187
42	72	106	189
43	74	107	190
44	76	108	192
45	78	109	194
46	80	110	196
47	81	111	198
48	83	112	200
49	85	113	201
50	87	114	203
51	89	115	205
52	90	116	207
53	92	117	209
54	94	118	210
55	96	119	212
56	98	120	214
57	100	121	216
58	101	122	218
59	103	123	220
60	105	124	221
61	107	125	223
62	109	126	225
63	110	127	227

Table #16
Dyna Release Time (ms)

Data	Value	Data	Value
0	2.6	64	369
1	3.0	65	391
2	3.4	66	413
3	3.9	67	434
4	4.3	68	456
5	4.7	69	478
6	5.2	70	499
7	5.6	71	521
8	6.0	72	543
9	6.5	73	565
10	6.9	74	586
11	7.3	75	608
12	7.8	76	630
13	8.2	77	651
14	8.6	78	673
15	13	79	695
16	17	80	717
17	22	81	738
18	26	82	760
19	30	83	782
20	35	84	803
21	39	85	825
22	43	86	847
23	48	87	869
24	52	88	890
25	56	89	912
26	61	90	934
27	65	91	955
28	69	92	977
29	74	93	999
30	78	94	1021
31	83	95	1042
32	87	96	1064
33	91	97	1086
34	96	98	1107
35	100	99	1129
36	104	100	1151
37	109	101	1173
38	113	102	1194
39	117	103	1216
40	122	104	1238
41	126	105	1259
42	130	106	1281
43	135	107	1303
44	139	108	1346
45	143	109	1390
46	148	110	1433
47	152	111	1477
48	156	112	1520
49	161	113	1563
50	165	114	1607
51	169	115	1650
52	174	116	1694
53	178	117	1737
54	182	118	1781
55	187	119	1824
56	195	120	1867
57	217	121	1911
58	239	122	1954
59	261	123	1998
60	282	124	2041
61	304	125	2085
62	326	126	2128
63	347	127	2171

Table #17
Ring Mod OSC Freq Coarse (Hz)

Data	Value	Data	Value
0	0.5	64	151
1	1.5	65	160
2	2.0	66	169
3	2.5	67	179
4	3.5	68	189
5	4.0	69	200
6	4.5	70	211
7	5.5	71	223
8	6.0	72	236
9	6.5	73	249
10	7.5	74	264
11	8.0	75	279
12	8.4	76	295
13	8.9	77	311
14	9.4	78	329
15	9.9	79	348
16	10.5	80	368
17	11.1	81	389
18	11.7	82	411
19	12.4	83	435
20	13.1	84	459
21	13.9	85	486
22	14.7	86	513
23	15.5	87	543
24	16.4	88	574
25	17.3	89	607
26	18.3	90	641
27	19.4	91	678
28	20.5	92	717
29	21.7	93	757
30	22.9	94	801
31	24.2	95	846
32	25.6	96	895
33	27.1	97	946
34	28.6	98	1.00k
35	30.3	99	1.05k
36	32.0	100	1.11k
37	33.8	101	1.18k
38	35.8	102	1.24k
39	37.8	103	1.32k
40	40.0	104	1.39k
41	42.2	105	1.47k
42	44.7	106	1.55k
43	47.2	107	1.64k
44	49.9	108	1.74k
45	52.7	109	1.84k
46	55.8	110	1.94k
47	58.9	111	2.05k
48	62.3	112	2.17k
49	65.9	113	2.29k
50	69.6	114	2.43k
51	73.6	115	2.56k
52	77.8	116	2.71k
53	82.3	117	2.87k
54	87.0	118	3.03k
55	91.9	119	3.20k
56	97.2	120	3.39k
57	102	121	3.58k
58	108	122	3.79k
59	114	123	4.00k
60	121	124	4.23k
61	128	125	4.47k
62	135	126	4.73k
63	143	127	5.00k

Table #18
Classic Flanger Delay Offset

Data	Value	Data	Value
0	0.09	70	6.35
1	0.11	71	6.67
2	0.13	72	7.01
3	0.15	73	7.37
4	0.18	74	7.74
5	0.20	75	8.13
6	0.22	76	8.54
7	0.24	77	8.97
8	0.27	78	9.41
9	0.29	79	9.85
10	0.31	80	10.29
11	0.34	81	10.73
12	0.36	82	11.17
13	0.38	83	11.61
14	0.40	84	12.05
15	0.42	85	12.49
16	0.43	86	12.93
17	0.46	87	13.37
18	0.48	88	13.81
19	0.51	89	14.24
20	0.53	90	14.68
21	0.56	91	15.12
22	0.59	92	15.56
23	0.62	93	16.00
24	0.65	94	16.44
25	0.68	95	16.88
26	0.72	96	17.32
27	0.76	97	17.76
28	0.79	98	18.20
29	0.83	99	18.64
30	0.88	100	19.08
31	0.92	101	19.52
32	0.97	102	19.96
33	1.02	103	20.40
34	1.07	104	20.83
35	1.12	105	21.27
36	1.18	106	21.71
37	1.24	107	22.15
38	1.30	108	22.59
39	1.37	109	23.03
40	1.44	110	23.47
41	1.51	111	23.91
42	1.59	112	24.35
43	1.67	113	24.79
44	1.76	114	25.23
45	1.84	115	25.66
46	1.94	116	26.10
47	2.04	117	26.54
48	2.14	118	26.98
49	2.25	119	27.42
50	2.36	120	27.86
51	2.48	121	28.30
52	2.61	122	28.74
53	2.74	123	29.18
54	2.88	124	29.62
55	3.03	125	30.06
56	3.18	126	30.50
57	3.34	127	30.94
58	3.51	128	31.38
59	3.69	129	31.82
60	3.87	130	32.25
61	4.07	131	32.69
62	4.28	132	33.13
63	4.49	133	33.57
64	4.72	134	34.01
65	4.96	135	34.45
66	5.21	136	34.89
67	5.47	137	35.33
68	5.75	138	35.77
69	6.04	139	36.21

Table #19
Modulation Phase

Data	Value
0	-180
1	-158
2	-135
3	-113
4	-90
5	-68
6	-45
7	-23
8	0
9	23
10	45
11	68
12	90
13	113
14	135
15	158
16	180

Table #20
VCM Flanger Speed

Data	Value	Data	Value	Data	Value	Data	Value
0	0.040	70	0.281	140	1.272	210	5.804
1	0.042	71	0.287	141	1.304	211	5.972
2	0.045	72	0.292	142	1.335	212	6.056
3	0.047	73	0.300	143	1.367	213	6.224
4	0.050	74	0.308	144	1.409	214	6.309
5	0.053	75	0.313	145	1.430	215	6.477
6	0.055	76	0.321	146	1.451	216	6.645
7	0.058	77	0.326	147	1.493	217	6.813
8	0.060	78	0.334	148	1.514	218	6.897
9	0.063	79	0.342	149	1.556	219	7.066
10	0.066	80	0.347	150	1.577	220	7.234
11	0.068	81	0.357	151	1.619	221	7.402
12	0.071	82	0.363	152	1.661	222	7.570
13	0.074	83	0.373	153	1.682	223	7.738
14	0.076	84	0.379	154	1.724	224	7.907
15	0.079	85	0.389	155	1.766	225	8.075
16	0.081	86	0.400	156	1.808	226	8.243
17	0.084	87	0.405	157	1.851	227	8.411
18	0.087	88	0.415	158	1.893	228	8.580
19	0.089	89	0.426	159	1.935	229	8.748
20	0.092	90	0.431	160	1.977	230	9.000
21	0.095	91	0.442	161	2.019	231	9.168
22	0.097	92	0.452	162	2.061	232	9.337
23	0.100	93	0.463	163	2.103	233	9.589
24	0.102	94	0.473	164	2.145	234	9.757
25	0.105	95	0.484	165	2.187	235	10.00
26	0.108	96	0.494	166	2.250		
27	0.110	97	0.505	167	2.292		
28	0.113	98	0.515	168	2.334		
29	0.116	99	0.526	169	2.397		
30	0.118	100	0.536	170	2.460		
31	0.121	101	0.547	171	2.502		
32	0.124	102	0.563	172	2.565		
33	0.126	103	0.573	173	2.608		
34	0.129	104	0.589	174	2.671		
35	0.131	105	0.599	175	2.733		
36	0.134	106	0.615	176	2.776		
37	0.137	107	0.626	177	2.860		
38	0.139	108	0.636	178	2.902		
39	0.145	109	0.652	179	2.986		
40	0.147	110	0.668	180	3.028		
41	0.150	111	0.683	181	3.112		
42	0.152	112	0.704	182	3.154		
43	0.158	113	0.715	183	3.238		
44	0.160	114	0.725	184	3.323		
45	0.163	115	0.747	185	3.365		
46	0.168	116	0.757	186	3.449		
47	0.171	117	0.778	187	3.533		
48	0.173	118	0.789	188	3.617		
49	0.179	119	0.810	189	3.701		
50	0.181	120	0.831	190	3.785		
51	0.187	121	0.852	191	3.869		
52	0.189	122	0.862	192	3.953		
53	0.195	123	0.883	193	4.037		
54	0.197	124	0.904	194	4.122		
55	0.202	125	0.925	195	4.206		
56	0.208	126	0.946	196	4.290		
57	0.210	127	0.967	197	4.374		
58	0.216	128	0.988	198	4.500		
59	0.221	129	1.009	199	4.584		
60	0.226	130	1.030	200	4.668		
61	0.231	131	1.051	201	4.752		
62	0.237	132	1.072	202	4.879		
63	0.242	133	1.093	203	5.005		
64	0.247	134	1.125	204	5.131		
65	0.252	135	1.146	205	5.215		
66	0.258	136	1.167	206	5.341		
67	0.263	137	1.199	207	5.467		
68	0.268	138	1.220	208	5.552		
69	0.273	139	1.251	209	5.720		

Table #21
VCM Phaser Speed

Data	Value	Data	Value	Data	Value	Data	Value
0	0.100	70	0.373	140	1.325	210	4.668
1	0.103	71	0.379	141	1.346	211	4.752
2	0.105	72	0.389	142	1.367	212	4.837
3	0.108	73	0.394	143	1.410	213	4.921
4	0.110	74	0.400	144	1.430	214	5.047
5	0.113	75	0.410	145	1.451	215	5.131
6	0.116	76	0.415	146	1.472	216	5.215
7	0.118	77	0.426	147	1.493	217	5.299
8	0.121	78	0.431	148	1.535	218	5.383
9	0.124	79	0.442	149	1.556	219	5.551
10	0.126	80	0.447	150	1.577	220	5.636
11	0.129	81	0.457	151	1.619	221	5.720
12	0.131	82	0.463	152	1.640	222	5.804
13	0.134	83	0.473	153	1.682	223	5.888
14	0.137	84	0.478	154	1.703	224	6.056
15	0.139	85	0.489	155	1.724	225	6.140
16	0.142	86	0.499	156	1.767	226	6.224
17	0.145	87	0.510	157	1.808	227	6.393
18	0.147	88	0.515	158	1.829	228	6.477
19	0.150	89	0.526	159	1.872	229	6.561
20	0.152	90	0.536	160	1.893	230	6.729
21	0.155	91	0.547	161	1.935	231	6.813
22	0.158	92	0.557	162	1.977	232	6.981
23	0.160	93	0.568	163	2.000	233	7.066
24	0.163	94	0.578	164	2.040	234	7.234
25	0.166	95	0.589	165	2.082	235	7.318
26	0.168	96	0.599	166	2.124	236	7.486
27	0.171	97	0.610	167	2.145	237	7.654
28	0.173	98	0.620	168	2.187	238	7.774
29	0.179	99	0.631	169	2.229	239	7.907
30	0.181	100	0.641	170	2.271	240	8.075
31	0.184	101	0.652	171	2.313	241	8.159
32	0.187	102	0.668	172	2.355	242	8.327
33	0.192	103	0.683	173	2.397	243	8.496
34	0.195	104	0.694	174	2.439	244	8.664
35	0.200	105	0.704	175	2.503	245	8.832
36	0.202	106	0.715	176	2.544	246	9.000
37	0.205	107	0.725	177	2.587	247	9.168
38	0.210	108	0.747	178	2.629	248	9.337
39	0.213	109	0.758	179	2.671	249	9.505
40	0.218	110	0.768	180	2.734	250	9.673
41	0.221	111	0.789	181	2.776	251	9.841
42	0.226	112	0.799	182	2.860	252	10.00
43	0.229	113	0.810	183	2.902		
44	0.234	114	0.831	184	2.944		
45	0.237	115	0.841	185	2.986		
46	0.242	116	0.862	186	3.028		
47	0.247	117	0.873	187	3.070		
48	0.250	118	0.894	188	3.154		
49	0.255	119	0.904	189	3.196		
50	0.260	120	0.925	190	3.280		
51	0.265	121	0.936	191	3.323		
52	0.271	122	0.957	192	3.365		
53	0.276	123	0.967	193	3.449		
54	0.281	124	0.988	194	3.491		
55	0.287	125	1.000	195	3.575		
56	0.289	126	1.030	196	3.659		
57	0.294	127	1.051	197	3.701		
58	0.300	128	1.062	198	3.785		
59	0.308	129	1.083	199	3.827		
60	0.310	130	1.104	200	3.911		
61	0.318	131	1.125	201	3.995		
62	0.323	132	1.146	202	4.080		
63	0.329	133	1.167	203	4.122		
64	0.334	134	1.188	204	4.206		
65	0.342	135	1.209	205	4.290		
66	0.347	136	1.230	206	4.374		
67	0.357	137	1.251	207	4.458		
68	0.363	138	1.272	208	4.500		
69	0.368	139	1.304	209	4.584		

Table #22
VCM Wah Speed

Data	Value	Data	Value	Data	Value	Data	Value
0	0.100	70	0.436	140	1.872	210	7.991
1	0.103	71	0.447	141	1.914	211	8.159
2	0.105	72	0.457	142	1.956	212	8.327
3	0.108	73	0.463	143	1.999	213	8.496
4	0.110	74	0.473	144	2.040	214	8.748
5	0.113	75	0.484	145	2.082	215	8.916
6	0.116	76	0.494	146	2.124	216	9.084
7	0.118	77	0.505	147	2.166	217	9.253
8	0.121	78	0.515	148	2.229	218	9.505
9	0.124	79	0.526	149	2.250	219	9.673
10	0.126	80	0.536	150	2.313	220	9.841
11	0.129	81	0.547	151	2.355	221	10.09
12	0.131	82	0.563	152	2.397	222	10.26
13	0.134	83	0.573	153	2.460	223	10.51
14	0.137	84	0.584	154	2.502	224	10.77
15	0.139	85	0.599	155	2.566	225	10.93
16	0.142	86	0.610	156	2.608	226	11.10
17	0.145	87	0.620	157	2.671	227	11.44
18	0.147	88	0.636	158	2.734	228	11.61
19	0.152	89	0.652	159	2.776	229	11.94
20	0.155	90	0.662	160	2.818	230	12.11
21	0.157	91	0.673	161	2.902	231	12.45
22	0.163	92	0.694	162	2.944	232	12.62
23	0.166	93	0.704	163	3.028	233	12.95
24	0.168	94	0.725	164	3.070	234	13.29
25	0.173	95	0.736	165	3.154	235	13.46
26	0.176	96	0.747	166	3.196	236	13.79
27	0.179	97	0.768	167	3.280	237	13.96
28	0.184	98	0.778	168	3.336	238	14.30
29	0.187	99	0.799	169	3.407	239	14.64
30	0.189	100	0.820	170	3.491	240	14.97
31	0.195	101	0.831	171	3.575	241	15.31
32	0.200	102	0.852	172	3.659	242	15.65
33	0.202	103	0.873	173	3.701	243	15.98
34	0.208	104	0.883	174	3.785	244	16.32
35	0.210	105	0.904	175	3.869	245	16.65
36	0.216	106	0.935	176	3.953	246	16.99
37	0.221	107	0.946	177	4.037	247	17.33
38	0.226	108	0.967	178	4.122	248	17.66
39	0.231	109	0.988	179	4.206	249	18.00
40	0.234	110	0.999	180	4.290	250	18.34
41	0.239	111	1.020	181	4.374	251	18.84
42	0.244	112	1.051	182	4.500	252	19.18
43	0.250	113	1.072	183	4.584	253	19.51
44	0.255	114	1.093	184	4.668	254	20.00
45	0.260	115	1.115	185	4.795		
46	0.265	116	1.136	186	4.879		
47	0.271	117	1.157	187	4.963		
48	0.276	118	1.188	188	5.090		
49	0.284	119	1.209	189	5.173		
50	0.289	120	1.241	190	5.299		
51	0.294	121	1.262	191	5.383		
52	0.302	122	1.293	192	5.552		
53	0.308	123	1.314	193	5.636		
54	0.315	124	1.346	194	5.720		
55	0.321	125	1.367	195	5.888		
56	0.326	126	1.409	196	5.972		
57	0.334	127	1.430	197	6.140		
58	0.342	128	1.451	198	6.224		
59	0.347	129	1.493	199	6.393		
60	0.357	130	1.514	200	6.477		
61	0.363	131	1.556	201	6.665		
62	0.368	132	1.598	202	6.813		
63	0.379	133	1.619	203	6.897		
64	0.384	134	1.661	204	7.066		
65	0.394	135	1.703	205	7.234		
66	0.405	136	1.724	206	7.402		
67	0.410	137	1.766	207	7.570		
68	0.421	138	1.808	208	7.654		
69	0.426	139	1.851	209	7.823		

Table #23
Rev Hall Time

Data	Value
0	0.3
1	0.4
2	0.5
3	0.6
4	0.7
5	0.8
6	0.9
7	1.0
8	1.1
9	1.2
10	1.3
11	1.4
12	1.5
13	1.6
14	1.7
15	1.8
16	1.9
17	2.0
18	2.1
19	2.2
20	2.3
21	2.4
22	2.5
23	2.6
24	2.7
25	2.8
26	2.9
27	3.0
28	3.1
29	3.2
30	3.3
31	3.4
32	3.5
33	3.6
34	3.7
35	3.8
36	3.9
37	4.0
38	4.1
39	4.2
40	4.3
41	4.4
42	4.5
43	4.6
44	4.7
45	4.8
46	4.9
47	5.0
48	5.5
49	6.0
50	6.5
51	7.0
52	7.5
53	8.0
54	8.5
55	9.0
56	9.5
57	10.0
58	10.5
59	11.0
60	11.5
61	12.0
62	12.5
63	13.0
64	13.5
65	14.0
66	15.0
67	16.0
68	17.0
69	18.0

Table #24
Rev Room Time

Data	Value
0	0.3
1	0.4
2	0.5
3	0.6
4	0.7
5	0.8
6	0.9
7	1.0
8	1.1
9	1.2
10	1.3
11	1.4
12	1.5
13	1.6
14	1.7
15	1.8
16	1.9
17	2.0
18	2.1
19	2.2
20	2.3
21	2.4
22	2.5
23	2.6
24	2.7
25	2.8
26	2.9
27	3.0
28	3.1
29	3.2
30	3.3
31	3.4
32	3.5
33	3.6
34	3.7
35	3.8
36	3.9
37	4.0
38	4.1
39	4.2
40	4.3
41	4.4
42	4.5
43	4.6
44	4.7
45	4.8
46	4.9
47	5.0
48	5.1
49	5.2
50	5.3
51	5.4
52	5.5
53	5.6
54	5.7
55	5.8
56	5.9
57	6.0
58	6.1
59	6.2
60	6.3
61	6.4
62	6.5
63	6.6
64	6.7
65	6.8
66	6.9
67	7.0
68	8.0
69	10.0

Table #25
VCM Comp Level

Data	Value	Data	Value	Data	Value
0	-∞dB	67	-28.50dB	134	-10.44dB
1	-138.0dB	68	-28.11dB	135	-10.24dB
2	-120.0dB	69	-27.73dB	136	-10.05dB
3	-109.4dB	70	-27.36dB	137	-9.86dB
4	-101.9dB	71	-26.99dB	138	-9.67dB
5	-96.12dB	72	-26.62dB	139	-9.48dB
6	-91.37dB	73	-26.26dB	140	-9.29dB
7	-87.36dB	74	-25.91dB	141	-9.11dB
8	-83.88dB	75	-25.56dB	142	-8.92dB
9	-80.81dB	76	-25.21dB	143	-8.74dB
10	-78.06dB	77	-24.87dB	144	-8.56dB
11	-75.58dB	78	-24.54dB	145	-8.38dB
12	-73.31dB	79	-24.20dB	146	-8.20dB
13	-71.23dB	80	-23.88dB	147	-8.02dB
14	-69.29dB	81	-23.55dB	148	-7.85dB
15	-67.50dB	82	-23.23dB	149	-7.67dB
16	-65.81dB	83	-22.92dB	150	-7.50dB
17	-64.23dB	84	-22.61dB	151	-7.32dB
18	-62.75dB	85	-22.30dB	152	-7.15dB
19	-61.34dB	86	-21.99dB	153	-6.98dB
20	-60.00dB	87	-21.69dB	154	-6.81dB
21	-58.73dB	88	-21.39dB	155	-6.64dB
22	-57.52dB	89	-21.10dB	156	-6.47dB
23	-56.36dB	90	-20.81dB	157	-6.31dB
24	-55.25dB	91	-20.52dB	158	-6.14dB
25	-54.19dB	92	-20.23dB	159	-5.98dB
26	-53.16dB	93	-19.95dB	160	-5.81dB
27	-52.18dB	94	-19.67dB	161	-5.65dB
28	-51.23dB	95	-19.40dB	162	-5.49dB
29	-50.32dB	96	-19.13dB	163	-5.33dB
30	-49.43dB	97	-18.86dB	164	-5.17dB
31	-48.58dB	98	-18.59dB	165	-5.01dB
32	-47.75dB	99	-18.32dB	166	-4.86dB
33	-46.95dB	100	-18.06dB	167	-4.70dB
34	-46.17dB	101	-17.80dB	168	-4.54dB
35	-45.42dB	102	-17.55dB	169	-4.39dB
36	-44.68dB	103	-17.29dB	170	-4.23dB
37	-43.97dB	104	-17.04dB	171	-4.08dB
38	-43.27dB	105	-16.79dB	172	-3.93dB
39	-42.60dB	106	-16.54dB	173	-3.78dB
40	-41.94dB	107	-16.30dB	174	-3.63dB
41	-41.29dB	108	-16.06dB	175	-3.48dB
42	-40.67dB	109	-15.82dB	176	-3.33dB
43	-40.05dB	110	-15.58dB	177	-3.18dB
44	-39.45dB	111	-15.34dB	178	-3.04dB
45	-38.87dB	112	-15.11dB	179	-2.89dB
46	-38.30dB	113	-14.88dB	180	-2.75dB
47	-37.74dB	114	-14.65dB	181	-2.60dB
48	-37.19dB	115	-14.42dB	182	-2.46dB
49	-36.65dB	116	-14.19dB	183	-2.31dB
50	-36.12dB	117	-13.97dB	184	-2.17dB
51	-35.61dB	118	-13.75dB	185	-2.03dB
52	-35.10dB	119	-13.53dB	186	-1.89dB
53	-34.61dB	120	-13.31dB	187	-1.75dB
54	-34.12dB	121	-13.09dB	188	-1.61dB
55	-33.64dB	122	-12.88dB	189	-1.47dB
56	-33.17dB	123	-12.67dB	190	-1.34dB
57	-32.71dB	124	-12.46dB	191	-1.20dB
58	-32.26dB	125	-12.25dB	192	-1.06dB
59	-31.81dB	126	-12.04dB	193	-0.93dB
60	-31.37dB	127	-11.83dB	194	-0.79dB
61	-30.94dB	128	-11.63dB	195	-0.66dB
62	-30.52dB	129	-11.43dB	196	-0.53dB
63	-30.10dB	130	-11.23dB	197	-0.39dB
64	-29.69dB	131	-11.03dB	198	-0.26dB
65	-29.29dB	132	-10.83dB	199	-0.13dB
66	-28.89dB	133	-10.63dB	200	0.00dB

Table #26
VCM Comp Attack Time

Data	Value	Data	Value	Data	Value
0	0.022ms	67	3.295ms	134	18.53ms
1	0.023ms	68	3.418ms	135	18.88ms
2	0.024ms	69	3.544ms	136	19.23ms
3	0.025ms	70	3.673ms	137	19.59ms
4	0.026ms	71	3.805ms	138	19.95ms
5	0.028ms	72	3.940ms	139	20.31ms
6	0.031ms	73	4.077ms	140	20.68ms
7	0.035ms	74	4.217ms	141	21.05ms
8	0.039ms	75	4.361ms	142	21.42ms
9	0.045ms	76	4.507ms	143	21.80ms
10	0.051ms	77	4.656ms	144	22.18ms
11	0.059ms	78	4.807ms	145	22.57ms
12	0.068ms	79	4.962ms	146	22.96ms
13	0.077ms	80	5.120ms	147	23.36ms
14	0.088ms	81	5.281ms	148	23.75ms
15	0.101ms	82	5.445ms	149	24.16ms
16	0.114ms	83	5.611ms	150	24.56ms
17	0.129ms	84	5.781ms	151	24.97ms
18	0.146ms	85	5.954ms	152	25.39ms
19	0.163ms	86	6.130ms	153	25.81ms
20	0.182ms	87	6.309ms	154	26.23ms
21	0.203ms	88	6.491ms	155	26.66ms
22	0.225ms	89	6.677ms	156	27.09ms
23	0.249ms	90	6.865ms	157	27.53ms
24	0.274ms	91	7.057ms	158	27.97ms
25	0.301ms	92	7.252ms	159	28.41ms
26	0.330ms	93	7.450ms	160	28.86ms
27	0.360ms	94	7.651ms	161	29.31ms
28	0.393ms	95	7.855ms	162	29.77ms
29	0.426ms	96	8.063ms	163	30.23ms
30	0.462ms	97	8.274ms	164	30.70ms
31	0.500ms	98	8.489ms	165	31.17ms
32	0.539ms	99	8.706ms	166	31.64ms
33	0.580ms	100	8.927ms	167	32.12ms
34	0.623ms	101	9.151ms	168	32.60ms
35	0.668ms	102	9.379ms	169	33.09ms
36	0.716ms	103	9.610ms	170	33.58ms
37	0.765ms	104	9.844ms	171	34.07ms
38	0.816ms	105	10.09ms	172	34.57ms
39	0.869ms	106	10.33ms	173	35.08ms
40	0.924ms	107	10.57ms	174	35.59ms
41	0.982ms	108	10.82ms	175	36.10ms
42	1.041ms	109	11.07ms	176	36.62ms
43	1.103ms	110	11.33ms	177	37.14ms
44	1.167ms	111	11.59ms	178	37.67ms
45	1.233ms	112	11.85ms	179	38.20ms
46	1.301ms	113	12.11ms	180	38.73ms
47	1.372ms	114	12.38ms	181	39.27ms
48	1.444ms	115	12.66ms	182	39.82ms
49	1.520ms	116	12.93ms	183	40.36ms
50	1.597ms	117	13.21ms	184	40.92ms
51	1.677ms	118	13.50ms	185	41.48ms
52	1.759ms	119	13.78ms	186	42.04ms
53	1.844ms	120	14.07ms	187	42.61ms
54	1.931ms	121	14.37ms	188	43.18ms
55	2.021ms	122	14.67ms	189	43.75ms
56	2.113ms	123	14.97ms	190	44.33ms
57	2.207ms	124	15.27ms	191	44.92ms
58	2.304ms	125	15.58ms	192	45.51ms
59	2.404ms	126	15.90ms	193	46.10ms
60	2.506ms	127	16.21ms	194	46.70ms
61	2.611ms	128	16.53ms	195	47.31ms
62	2.718ms	129	16.86ms	196	47.91ms
63	2.828ms	130	17.18ms	197	48.53ms
64	2.941ms	131	17.52ms	198	49.15ms
65	3.056ms	132	17.85ms	199	49.77ms
66	3.174ms	133	18.19ms	200	50.40ms

Table #27
VCM Comp Release Time

Data	Value	Data	Value	Data	Value
0	10.88ms	67	70.74ms	134	250.30ms
1	10.90ms	68	72.54ms	135	253.88ms
2	10.94ms	69	74.36ms	136	257.50ms
3	11.00ms	70	76.22ms	137	261.14ms
4	11.10ms	71	78.10ms	138	264.80ms
5	11.22ms	72	80.00ms	139	268.50ms
6	11.36ms	73	81.94ms	140	272.22ms
7	11.54ms	74	83.90ms	141	275.96ms
8	11.74ms	75	85.88ms	142	279.74ms
9	11.96ms	76	87.90ms	143	283.54ms
10	12.22ms	77	89.94ms	144	287.36ms
11	12.50ms	78	92.00ms	145	291.22ms
12	12.80ms	79	94.10ms	146	295.10ms
13	13.14ms	80	96.22ms	147	299.00ms
14	13.50ms	81	98.36ms	148	302.94ms
15	13.88ms	82	100.54ms	149	306.90ms
16	14.30ms	83	102.74ms	150	310.88ms
17	14.74ms	84	104.96ms	151	314.90ms
18	15.20ms	85	107.22ms	152	318.94ms
19	15.70ms	86	109.50ms	153	323.00ms
20	16.22ms	87	111.80ms	154	327.10ms
21	16.76ms	88	114.14ms	155	331.22ms
22	17.34ms	89	116.50ms	156	335.36ms
23	17.94ms	90	118.88ms	157	339.54ms
24	18.56ms	91	121.30ms	158	343.74ms
25	19.22ms	92	123.74ms	159	347.96ms
26	19.90ms	93	126.20ms	160	352.22ms
27	20.60ms	94	128.70ms	161	356.50ms
28	21.34ms	95	131.22ms	162	360.80ms
29	22.10ms	96	133.76ms	163	365.14ms
30	22.88ms	97	136.34ms	164	369.50ms
31	23.70ms	98	138.94ms	165	373.88ms
32	24.54ms	99	141.56ms	166	378.30ms
33	25.40ms	100	144.22ms	167	382.74ms
34	26.30ms	101	146.90ms	168	387.20ms
35	27.22ms	102	149.60ms	169	391.70ms
36	28.16ms	103	152.34ms	170	396.22ms
37	29.14ms	104	155.10ms	171	400.76ms
38	30.14ms	105	157.88ms	172	405.34ms
39	31.16ms	106	160.70ms	173	409.94ms
40	32.22ms	107	163.54ms	174	414.56ms
41	33.30ms	108	166.40ms	175	419.22ms
42	34.40ms	109	169.30ms	176	423.90ms
43	35.54ms	110	172.22ms	177	428.60ms
44	36.70ms	111	175.16ms	178	433.34ms
45	37.88ms	112	178.14ms	179	438.10ms
46	39.10ms	113	181.14ms	180	442.88ms
47	40.34ms	114	184.16ms	181	447.70ms
48	41.60ms	115	187.22ms	182	452.54ms
49	42.90ms	116	190.30ms	183	457.40ms
50	44.22ms	117	193.40ms	184	462.30ms
51	45.56ms	118	196.54ms	185	467.22ms
52	46.94ms	119	199.70ms	186	472.16ms
53	48.34ms	120	202.88ms	187	477.14ms
54	49.76ms	121	206.10ms	188	482.14ms
55	51.22ms	122	209.34ms	189	487.16ms
56	52.70ms	123	212.60ms	190	492.22ms
57	54.20ms	124	215.90ms	191	497.30ms
58	55.74ms	125	219.22ms	192	502.40ms
59	57.30ms	126	222.56ms	193	507.54ms
60	58.88ms	127	225.94ms	194	512.70ms
61	60.50ms	128	229.34ms	195	517.88ms
62	62.14ms	129	232.76ms	196	523.10ms
63	63.80ms	130	236.22ms	197	528.34ms
64	65.50ms	131	239.70ms	198	533.60ms
65	67.22ms	132	243.20ms	199	538.90ms
66	68.96ms	133	246.74ms	200	544.22ms

Table #28
VCM EQ Frequency

Data	Value	Data	Value
0	16.0Hz	69	850Hz
1	17.0Hz	70	900Hz
2	18.0Hz	71	950Hz
3	19.0Hz	72	1.00kHz
4	20.0Hz	73	1.06kHz
5	21.2Hz	74	1.12kHz
6	22.4Hz	75	1.18kHz
7	23.6Hz	76	1.25kHz
8	25.0Hz	77	1.32kHz
9	26.5Hz	78	1.40kHz
10	28.0Hz	79	1.50kHz
11	30.0Hz	80	1.60kHz
12	31.5Hz	81	1.70kHz
13	33.5Hz	82	1.80kHz
14	35.5Hz	83	1.90kHz
15	37.5Hz	84	2.00kHz
16	40.0Hz	85	2.12kHz
17	42.5Hz	86	2.24kHz
18	45.0Hz	87	2.36kHz
19	47.5Hz	88	2.50kHz
20	50.0Hz	89	2.65kHz
21	53.0Hz	90	2.80kHz
22	56.0Hz	91	3.00kHz
23	60.0Hz	92	3.15kHz
24	63.0Hz	93	3.35kHz
25	67.0Hz	94	3.55kHz
26	71.0Hz	95	3.75kHz
27	75.0Hz	96	4.00kHz
28	80.0Hz	97	4.25kHz
29	85.0Hz	98	4.50kHz
30	90.0Hz	99	4.75kHz
31	95.0Hz	100	5.00kHz
32	100Hz	101	5.30kHz
33	106Hz	102	5.60kHz
34	112Hz	103	6.00kHz
35	118Hz	104	6.30kHz
36	125Hz	105	6.70kHz
37	132Hz	106	7.10kHz
38	140Hz	107	7.50kHz
39	150Hz	108	8.00kHz
40	160Hz	109	8.50kHz
41	170Hz	110	9.00kHz
42	180Hz	111	9.50kHz
43	190Hz	112	10.0kHz
44	200Hz	113	10.6kHz
45	212Hz	114	11.2kHz
46	224Hz	115	11.8kHz
47	236Hz	116	12.5kHz
48	250Hz	117	13.2kHz
49	265Hz	118	14.0kHz
50	280Hz	119	15.0kHz
51	300Hz	120	16.0kHz
52	315Hz	121	17.0kHz
53	335Hz	122	18.0kHz
54	355Hz	123	19.0kHz
55	375Hz	124	20.0kHz
56	400Hz	125	21.2kHz
57	425Hz	126	22.4kHz
58	450Hz	127	23.6kHz
59	475Hz	128	25.0kHz
60	500Hz	129	26.5kHz
61	530Hz	130	28.0kHz
62	560Hz	131	30.0kHz
63	600Hz	132	31.5kHz
64	630Hz	133	33.5kHz
65	670Hz	134	35.5kHz
66	710Hz	135	37.5kHz
67	750Hz	136	40.0kHz
68	800Hz		

Table #29
VCM EQ Q

Data	Value
0	0.50
1	0.53
2	0.56
3	0.59
4	0.63
5	0.67
6	0.71
7	0.75
8	0.79
9	0.84
10	0.89
11	0.94
12	1.00
13	1.06
14	1.12
15	1.19
16	1.26
17	1.33
18	1.41
19	1.50
20	1.59
21	1.68
22	1.78
23	1.89
24	2.00
25	2.12
26	2.24
27	2.38
28	2.52
29	2.67
30	2.83
31	3.00
32	3.17
33	3.36
34	3.56
35	3.78
36	4.00
37	4.24
38	4.49
39	4.76
40	5.04
41	5.34
42	5.66
43	5.99
44	6.35
45	6.73
46	7.13
47	7.55
48	8.00
49	8.48
50	8.98
51	9.51
52	10.08
53	10.68
54	11.31
55	11.99
56	12.70
57	13.45
58	14.25
59	15.10
60	16.00

Table #30
Speaker Type

Data	Value
0	Off
1	BS 4x12
2	AC 2x12
3	AC 1x12
4	AC 4x10
5	BC 2x12
6	AM 4x12
7	YC 4x12
8	JC 2x12
9	OC 2x12
10	OC 1x8

Table #31
Speaker Type 2

Data	Value
0	Off
1	Stack
2	Twin
3	Tweed
4	Oldies
5	Modern
6	Mean
7	Soft
8	Small
9	Dip1
10	Dip2
11	Metal
12	Light

Table #32
Distortion Type

Data	Value
0	Raw1
1	Vintage1
2	Modern1
3	Raw2
4	Vintage2
5	Modern2

Table #33
Wah Switch

Data	Value
0	Off
1	Wah Pedal
2	Auto+ Full
3	Auto+ Mid
4	Auto+ Light
5	Auto- Full
6	Auto- Mid
7	Auto- Light

Table #34
Distortion Switch

Data	Value
0	Off
1	Overdrive
2	Distortion1
3	Distortion2
4	Clean
5	Crunch
6	Hi-Gain
7	Modern

Table #35
Distortion EQ

Data	Value
0	High Boost
1	Mid Boost
2	Mid Cut 1
3	Mid Cut 2
4	Mid Cut 3
5	Low Cut 1
6	Low Cut 2
7	High Cut
8	High/Low

Table #36
LFO Speed

Data	Value	Data	Value
0	0.100	64	1.009
1	0.103	65	1.051
2	0.105	66	1.093
3	0.110	67	1.125
4	0.113	68	1.167
5	0.118	69	1.220
6	0.124	70	1.262
7	0.129	71	1.304
8	0.131	72	1.346
9	0.137	73	1.409
10	0.142	74	1.451
11	0.147	75	1.514
12	0.152	76	1.556
13	0.158	77	1.619
14	0.166	78	1.682
15	0.171	79	1.745
16	0.176	80	1.808
17	0.184	81	1.872
18	0.192	82	1.956
19	0.197	83	2.019
20	0.205	84	2.103
21	0.213	85	2.166
22	0.221	86	2.250
23	0.229	87	2.334
24	0.237	88	2.418
25	0.247	89	2.502
26	0.255	90	2.608
27	0.265	91	2.692
28	0.276	92	2.776
29	0.284	93	2.902
30	0.294	94	2.986
31	0.308	95	3.112
32	0.318	96	3.238
33	0.329	97	3.365
34	0.342	98	3.491
35	0.352	99	3.617
36	0.368	100	3.743
37	0.379	101	3.869
38	0.394	102	4.037
39	0.410	103	4.164
40	0.426	104	4.332
41	0.442	105	4.500
42	0.457	106	4.668
43	0.473	107	4.837
44	0.489	108	5.005
45	0.510	109	5.173
46	0.526	110	5.383
47	0.547	111	5.552
48	0.568	112	5.804
49	0.589	113	5.972
50	0.610	114	6.224
51	0.631	115	6.393
52	0.657	116	6.645
53	0.673	117	6.897
54	0.704	118	7.150
55	0.725	119	7.402
56	0.757	120	7.738
57	0.789	121	7.991
58	0.810	122	8.327
59	0.841	123	8.580
60	0.873	124	8.916
61	0.904	125	9.253
62	0.946	126	9.589
63	0.978	127	9.925

Table #37
Phaser Switch

Data	Value
0	Off
1	Standard
2	Wide
3	Vibe
4	Tremolo

Table #38
Delay Switch

Data	Value
0	Off
1	Delay M
2	Echo1 M
3	Echo2 M
4	Chorus M
5	DI Chorus M
6	Flanger1 M
7	Flanger2 M
8	Flanger3 M
9	Delay St
10	Echo1 St
11	Echo2 St
12	Chorus St
13	DI Chorus St
14	Flanger1 St
15	Flanger2 St
16	Flanger3 St

Table #39
EQ Frequency

Data	Value	Data	Value	Data	Value	Data	Value
0	16.0	70	118	140	900	210	6.70k
1	16.3	71	122	141	917	211	6.88k
2	17.0	72	125	142	950	212	7.10k
3	17.3	73	130	143	972	213	7.29k
4	18.0	74	132	144	1.00k	214	7.50k
5	18.3	75	137	145	1.03k	215	7.72k
6	19.0	76	140	146	1.06k	216	8.00k
7	19.4	77	145	147	1.09k	217	8.18k
8	20.0	78	150	148	1.12k	218	8.50k
9	20.5	79	154	149	1.15k	219	8.66k
10	21.2	80	160	150	1.18k	220	9.00k
11	21.8	81	163	151	1.22k	221	9.17k
12	22.4	82	170	152	1.25k	222	9.50k
13	23.0	83	173	153	1.30k	223	9.72k
14	23.6	84	180	154	1.32k	224	10.0k
15	24.4	85	183	155	1.37k	225	10.3k
16	25.0	86	190	156	1.40k	226	10.6k
17	25.9	87	194	157	1.45k	227	10.9k
18	26.5	88	200	158	1.50k	228	11.2k
19	27.4	89	205	159	1.54k	229	11.5k
20	28.0	90	212	160	1.60k	230	11.8k
21	29.0	91	218	161	1.63k	231	12.2k
22	30.0	92	224	162	1.70k	232	12.5k
23	30.7	93	230	163	1.73k	233	13.0k
24	31.5	94	236	164	1.80k	234	13.2k
25	32.5	95	244	165	1.83k	235	13.7k
26	33.5	96	250	166	1.90k	236	14.0k
27	34.5	97	259	167	1.94k	237	14.5k
28	35.5	98	265	168	2.00k	238	15.0k
29	36.5	99	274	169	2.05k	239	15.4k
30	37.5	100	280	170	2.12k	240	16.0k
31	38.7	101	290	171	2.18k	241	16.3k
32	40.0	102	300	172	2.24k	242	17.0k
33	41.0	103	307	173	2.30k	243	17.3k
34	42.5	104	315	174	2.36k	244	18.0k
35	43.4	105	325	175	2.44k	245	18.3k
36	45.0	106	335	176	2.50k	246	19.0k
37	46.0	107	345	177	2.59k	247	19.4k
38	47.5	108	355	178	2.65k	248	20.0k
39	48.7	109	365	179	2.74k	249	20.5k
40	50.0	110	375	180	2.80k	250	21.2k
41	51.6	111	387	181	2.90k	251	21.8k
42	53.0	112	400	182	3.00k	252	22.4k
43	54.6	113	410	183	3.07k	253	23.0k
44	56.0	114	425	184	3.15k	254	23.6k
45	57.9	115	434	185	3.25k	255	24.4k
46	60.0	116	450	186	3.35k		
47	61.3	117	460	187	3.45k		
48	63.0	118	475	188	3.55k		
49	64.9	119	487	189	3.65k		
50	67.0	120	500	190	3.75k		
51	68.8	121	516	191	3.87k		
52	71.0	122	530	192	4.00k		
53	72.9	123	546	193	4.10k		
54	75.0	124	560	194	4.25k		
55	77.2	125	579	195	4.34k		
56	80.0	126	600	196	4.50k		
57	81.8	127	613	197	4.60k		
58	85.0	128	630	198	4.75k		
59	86.6	129	649	199	4.87k		
60	90.0	130	670	200	5.00k		
61	91.7	131	688	201	5.16k		
62	95.0	132	710	202	5.30k		
63	97.2	133	729	203	5.46k		
64	100	134	750	204	5.60k		
65	103	135	772	205	5.79k		
66	106	136	800	206	6.00k		
67	109	137	818	207	6.13k		
68	112	138	850	208	6.30k		
69	115	139	866	209	6.49k		

Table #40
Beat Repeat Ratio

Data	Value
0	1/32
1	1/24
2	1/16
3	1/12
4	1/8
5	1/6
6	1/4
7	1/3
8	1/2
9	2/3
10	1

Table #41
Delay Time (short)

Data	Value	Data	Value
0	25.0ms	64	143.4ms
1	25.7ms	65	147.3ms
2	26.4ms	66	151.4ms
3	27.1ms	67	155.6ms
4	27.9ms	68	159.9ms
5	28.7ms	69	164.3ms
6	29.4ms	70	168.9ms
7	30.3ms	71	173.5ms
8	31.1ms	72	178.3ms
9	32.0ms	73	183.3ms
10	32.8ms	74	188.3ms
11	33.8ms	75	193.6ms
12	34.7ms	76	198.9ms
13	35.6ms	77	204.4ms
14	36.6ms	78	210.1ms
15	37.6ms	79	215.9ms
16	38.7ms	80	221.9ms
17	39.8ms	81	228.0ms
18	40.9ms	82	234.3ms
19	42.0ms	83	240.8ms
20	43.1ms	84	247.4ms
21	44.3ms	85	254.3ms
22	45.6ms	86	261.3ms
23	46.8ms	87	268.6ms
24	48.1ms	88	276.0ms
25	49.5ms	89	283.6ms
26	50.8ms	90	291.5ms
27	52.2ms	91	299.5ms
28	53.7ms	92	307.8ms
29	55.2ms	93	316.3ms
30	56.7ms	94	325.1ms
31	58.3ms	95	334.1ms
32	59.9ms	96	343.3ms
33	61.5ms	97	352.8ms
34	63.2ms	98	362.6ms
35	65.0ms	99	372.6ms
36	66.8ms	100	382.9ms
37	68.6ms	101	393.5ms
38	70.5ms	102	404.4ms
39	72.5ms	103	415.6ms
40	74.5ms	104	427.1ms
41	76.5ms	105	438.9ms
42	78.7ms	106	451.0ms
43	80.8ms	107	463.5ms
44	83.1ms	108	476.3ms
45	85.4ms	109	489.5ms
46	87.7ms	110	503.1ms
47	90.1ms	111	517.0ms
48	92.6ms	112	531.3ms
49	95.2ms	113	546.0ms
50	97.8ms	114	561.1ms
51	100.5ms	115	576.6ms
52	103.3ms	116	592.5ms
53	106.2ms	117	608.9ms
54	109.1ms	118	625.8ms
55	112.1ms	119	643.1ms
56	115.2ms	120	660.9ms
57	118.4ms	121	679.2ms
58	121.7ms	122	698.0ms
59	125.1ms	123	717.3ms
60	128.5ms	124	737.1ms
61	132.1ms	125	757.5ms
62	135.7ms	126	778.5ms
63	139.5ms	127	800.0ms

Table #42
Delay Time (long)

Data	Value	Data	Value
0	50.0ms	64	226.3ms
1	51.2ms	65	231.7ms
2	52.4ms	66	237.2ms
3	53.7ms	67	242.9ms
4	54.9ms	68	248.6ms
5	56.3ms	69	254.6ms
6	57.6ms	70	260.7ms
7	59.0ms	71	266.9ms
8	60.4ms	72	273.3ms
9	61.8ms	73	279.8ms
10	63.3ms	74	286.5ms
11	64.8ms	75	293.3ms
12	66.4ms	76	300.3ms
13	67.9ms	77	307.5ms
14	69.6ms	78	314.8ms
15	71.2ms	79	322.3ms
16	72.9ms	80	330.0ms
17	74.7ms	81	337.9ms
18	76.4ms	82	345.9ms
19	78.3ms	83	354.2ms
20	80.1ms	84	362.7ms
21	82.1ms	85	371.3ms
22	84.0ms	86	380.2ms
23	86.0ms	87	389.2ms
24	88.1ms	88	398.5ms
25	90.2ms	89	408.1ms
26	92.3ms	90	417.8ms
27	94.5ms	91	427.8ms
28	96.8ms	92	438.0ms
29	99.1ms	93	448.4ms
30	101.5ms	94	459.1ms
31	103.9ms	95	470.1ms
32	106.4ms	96	481.3ms
33	108.9ms	97	492.8ms
34	111.5ms	98	504.6ms
35	114.2ms	99	516.6ms
36	116.9ms	100	528.9ms
37	119.7ms	101	541.6ms
38	122.5ms	102	554.5ms
39	125.5ms	103	567.7ms
40	128.5ms	104	581.3ms
41	131.5ms	105	595.1ms
42	134.7ms	106	609.4ms
43	137.9ms	107	623.9ms
44	141.2ms	108	638.8ms
45	144.5ms	109	654.0ms
46	148.0ms	110	669.6ms
47	151.5ms	111	685.6ms
48	155.1ms	112	702.0ms
49	158.8ms	113	718.8ms
50	162.6ms	114	735.9ms
51	166.5ms	115	753.5ms
52	170.5ms	116	771.5ms
53	174.5ms	117	789.9ms
54	178.7ms	118	808.7ms
55	183.0ms	119	828.0ms
56	187.3ms	120	847.8ms
57	191.8ms	121	868.0ms
58	196.4ms	122	888.7ms
59	201.1ms	123	910.0ms
60	205.9ms	124	931.7ms
61	210.8ms	125	953.9ms
62	215.8ms	126	976.7ms
63	221.0ms	127	1000.0ms

Table #43
Analog Delay Retro

Data	Value
0	Mellow
1	Dub
2	Narrow
3	Soft
4	Dark

Table #44
Analog Delay Modern

Data	Value
0	Urban
1	Dub
2	Narrow
3	Soft
4	Dark

Table #45
Side Chain Input Level

Data	Value	Data	Value
0	-∞dB	64	-7.5dB
1	-62.0dB	65	-7.0dB
2	-59.0dB	66	-6.5dB
3	-56.0dB	67	-6.0dB
4	-54.0dB	68	-5.5dB
5	-52.0dB	69	-5.0dB
6	-50.0dB	70	-4.5dB
7	-48.0dB	71	-4.0dB
8	-47.0dB	72	-3.5dB
9	-46.0dB	73	-3.0dB
10	-45.0dB	74	-2.5dB
11	-44.0dB	75	-2.0dB
12	-43.0dB	76	-1.5dB
13	-42.0dB	77	-1.0dB
14	-41.0dB	78	-0.5dB
15	-40.0dB	79	0.0dB
16	-39.0dB	80	0.5dB
17	-38.0dB	81	1.0dB
18	-37.0dB	82	1.5dB
19	-36.0dB	83	2.0dB
20	-35.0dB	84	2.5dB
21	-34.0dB	85	3.0dB
22	-33.0dB	86	3.5dB
23	-32.0dB	87	4.0dB
24	-31.0dB	88	4.5dB
25	-30.0dB	89	5.0dB
26	-29.0dB	90	5.5dB
27	-28.0dB	91	6.0dB
28	-27.0dB	92	6.5dB
29	-26.0dB	93	7.0dB
30	-25.0dB	94	7.5dB
31	-24.0dB	95	8.0dB
32	-23.5dB	96	8.5dB
33	-23.0dB	97	9.0dB
34	-22.5dB	98	9.5dB
35	-22.0dB	99	10.0dB
36	-21.5dB	100	10.5dB
37	-21.0dB	101	11.0dB
38	-20.5dB	102	11.5dB
39	-20.0dB	103	12.0dB
40	-19.5dB	104	12.5dB
41	-19.0dB	105	13.0dB
42	-18.5dB	106	13.5dB
43	-18.0dB	107	14.0dB
44	-17.5dB	108	14.5dB
45	-17.0dB	109	15.0dB
46	-16.5dB	110	15.5dB
47	-16.0dB	111	16.0dB
48	-15.5dB	112	16.5dB
49	-15.0dB	113	17.0dB
50	-14.5dB	114	17.5dB
51	-14.0dB	115	18.0dB
52	-13.5dB	116	18.5dB
53	-13.0dB	117	19.0dB
54	-12.5dB	118	19.5dB
55	-12.0dB	119	20.0dB
56	-11.5dB	120	20.5dB
57	-11.0dB	121	21.0dB
58	-10.5dB	122	21.5dB
59	-10.0dB	123	22.0dB
60	-9.5dB	124	22.5dB
61	-9.0dB	125	23.0dB
62	-8.5dB	126	23.5dB
63	-8.0dB	127	24.0dB

Table #46
Beat Report Cutoff

Data	Value	Data	Value
0	14.1Hz	64	562Hz
1	15.0Hz	65	596Hz
2	15.8Hz	66	631Hz
3	16.8Hz	67	668Hz
4	17.8Hz	68	708Hz
5	18.8Hz	69	750Hz
6	20.0Hz	70	794Hz
7	21.1Hz	71	841Hz
8	22.4Hz	72	891Hz
9	23.7Hz	73	944Hz
10	25.1Hz	74	1.00kHz
11	26.6Hz	75	1.06kHz
12	28.2Hz	76	1.12kHz
13	29.9Hz	77	1.19kHz
14	31.6Hz	78	1.26kHz
15	33.5Hz	79	1.33kHz
16	35.5Hz	80	1.41kHz
17	37.6Hz	81	1.50kHz
18	39.8Hz	82	1.58kHz
19	42.2Hz	83	1.68kHz
20	44.7Hz	84	1.78kHz
21	47.3Hz	85	1.88kHz
22	50.1Hz	86	2.00kHz
23	53.1Hz	87	2.11kHz
24	56.2Hz	88	2.24kHz
25	59.6Hz	89	2.37kHz
26	63.1Hz	90	2.51kHz
27	66.8Hz	91	2.66kHz
28	70.8Hz	92	2.82kHz
29	75.0Hz	93	2.99kHz
30	79.4Hz	94	3.16kHz
31	84.1Hz	95	3.35kHz
32	89.1Hz	96	3.55kHz
33	94.4Hz	97	3.76kHz
34	100Hz	98	3.98kHz
35	106Hz	99	4.22kHz
36	112Hz	100	4.47kHz
37	119Hz	101	4.73kHz
38	126Hz	102	5.01kHz
39	133Hz	103	5.31kHz
40	141Hz	104	5.62kHz
41	150Hz	105	5.96kHz
42	158Hz	106	6.31kHz
43	168Hz	107	6.68kHz
44	178Hz	108	7.08kHz
45	188Hz	109	7.50kHz
46	200Hz	110	7.94kHz
47	211Hz	111	8.41kHz
48	224Hz	112	8.91kHz
49	237Hz	113	9.44kHz
50	251Hz	114	10.0kHz
51	266Hz	115	10.6kHz
52	282Hz	116	11.2kHz
53	299Hz	117	11.9kHz
54	316Hz	118	12.6kHz
55	335Hz	119	13.3kHz
56	355Hz	120	14.1kHz
57	376Hz	121	15.0kHz
58	398Hz	122	15.8kHz
59	422Hz	123	16.8kHz
60	447Hz	124	17.8kHz
61	473Hz	125	18.8kHz
62	501Hz	126	20.0kHz
63	531Hz	127	21.1kHz

Table #47
Beat Report Gain

Data	Value	Data	Value
1	-19.50dB	65	-3.50dB
2	-19.25dB	66	-3.25dB
3	-19.00dB	67	-3.00dB
4	-18.75dB	68	-2.75dB
5	-18.50dB	69	-2.50dB
6	-18.25dB	70	-2.25dB
7	-18.00dB	71	-2.00dB
8	-17.75dB	72	-1.75dB
9	-17.50dB	73	-1.50dB
10	-17.25dB	74	-1.25dB
11	-17.00dB	75	-1.00dB
12	-16.75dB	76	-0.75dB
13	-16.50dB	77	-0.50dB
14	-16.25dB	78	-0.25dB
15	-16.00dB	79	0.00dB
16	-15.75dB	80	0.25dB
17	-15.50dB	81	0.50dB
18	-15.25dB	82	0.75dB
19	-15.00dB	83	1.00dB
20	-14.75dB	84	1.25dB
21	-14.50dB	85	1.50dB
22	-14.25dB	86	1.75dB
23	-14.00dB	87	2.00dB
24	-13.75dB	88	2.25dB
25	-13.50dB	89	2.50dB
26	-13.25dB	90	2.75dB
27	-13.00dB	91	3.00dB
28	-12.75dB	92	3.25dB
29	-12.50dB	93	3.50dB
30	-12.25dB	94	3.75dB
31	-12.00dB	95	4.00dB
32	-11.75dB	96	4.25dB
33	-11.50dB	97	4.50dB
34	-11.25dB	98	4.75dB
35	-11.00dB	99	5.00dB
36	-10.75dB	100	5.25dB
37	-10.50dB	101	5.50dB
38	-10.25dB	102	5.75dB
39	-10.00dB	103	6.00dB
40	-9.75dB	104	6.25dB
41	-9.50dB	105	6.50dB
42	-9.25dB	106	6.75dB
43	-9.00dB	107	7.00dB
44	-8.75dB	108	7.25dB
45	-8.50dB	109	7.50dB
46	-8.25dB	110	7.75dB
47	-8.00dB	111	8.00dB
48	-7.75dB	112	8.25dB
49	-7.50dB	113	8.50dB
50	-7.25dB	114	8.75dB
51	-7.00dB	115	9.00dB
52	-6.75dB	116	9.25dB
53	-6.50dB	117	9.50dB
54	-6.25dB	118	9.75dB
55	-6.00dB	119	10.00dB
56	-5.75dB	120	10.25dB
57	-5.50dB	121	10.50dB
58	-5.25dB	122	10.75dB
59	-5.00dB	123	11.00dB
60	-4.75dB	124	11.25dB
61	-4.50dB	125	11.50dB
62	-4.25dB	126	11.75dB
63	-4.00dB	127	12.00dB
64	-3.75dB		

Table #48
Beat Report Length

Data	Value	Data	Value
0	1/256.00	64	1/6.00
1	1/224.00	65	1/5.90
2	1/192.00	66	1/5.80
3	1/172.00	67	1/5.70
4	1/161.00	68	1/5.60
5	1/151.00	69	1/5.50
6	1/140.00	70	1/5.40
7	1/128.00	71	1/5.30
8	1/116.00	72	1/5.20
9	1/108.00	73	1/5.10
10	1/104.00	74	1/5.00
11	1/96.00	75	1/4.90
12	1/92.00	76	1/4.80
13	1/88.00	77	1/4.70
14	1/84.00	78	1/4.60
15	1/80.00	79	1/4.50
16	1/76.00	80	1/4.40
17	1/72.00	81	1/4.30
18	1/68.00	82	1/4.20
19	1/64.00	83	1/4.10
20	1/56.00	84	1/4.00
21	1/48.00	85	1/3.90
22	1/40.00	86	1/3.80
23	1/36.00	87	1/3.70
24	1/32.00	88	1/3.60
25	1/30.00	89	1/3.50
26	1/28.00	90	1/3.40
27	1/26.00	91	1/3.30
28	1/24.00	92	1/3.20
29	1/22.00	93	1/3.10
30	1/20.00	94	1/3.00
31	1/19.00	95	1/2.90
32	1/18.00	96	1/2.80
33	1/17.00	97	1/2.70
34	1/16.00	98	1/2.60
35	1/15.00	99	1/2.50
36	1/14.00	100	1/2.40
37	1/13.50	101	1/2.30
38	1/13.00	102	1/2.25
39	1/12.50	103	1/2.20
40	1/12.00	104	1/2.15
41	1/11.50	105	1/2.10
42	1/11.00	106	1/2.05
43	1/10.50	107	1/2.00
44	1/10.00	108	1/1.95
45	1/9.50	109	1/1.90
46	1/9.00	110	1/1.85
47	1/8.75	111	1/1.80
48	1/8.50	112	1/1.75
49	1/8.25	113	1/1.70
50	1/8.00	114	1/1.65
51	1/7.75	115	1/1.60
52	1/7.50	116	1/1.55
53	1/7.25	117	1/1.50
54	1/7.00	118	1/1.45
55	1/6.90	119	1/1.40
56	1/6.80	120	1/1.35
57	1/6.70	121	1/1.30
58	1/6.60	122	1/1.25
59	1/6.50	123	1/1.20
60	1/6.40	124	1/1.15
61	1/6.30	125	1/1.10
62	1/6.20	126	1/1.05
63	1/6.10	127	1/1.00

Table #49
Rotary123 Windup/down Accel

Data	Value	Data	Value
14	0.21	78	1.22
15	0.22	79	1.24
16	0.24	80	1.25
17	0.25	81	1.27
18	0.27	82	1.29
19	0.29	83	1.30
20	0.30	84	1.32
21	0.32	85	1.33
22	0.33	86	1.35
23	0.35	87	1.37
24	0.37	88	1.38
25	0.38	89	1.40
26	0.40	90	1.41
27	0.41	91	1.43
28	0.43	92	1.44
29	0.44	93	1.46
30	0.46	94	1.48
31	0.48	95	1.49
32	0.49	96	1.51
33	0.51	97	1.52
34	0.52	98	1.54
35	0.54	99	1.56
36	0.56	100	1.57
37	0.57	101	1.59
38	0.59	102	1.60
39	0.60	103	1.62
40	0.62	104	1.63
41	0.63	105	1.65
42	0.65	106	1.67
43	0.67	107	1.68
44	0.68	108	1.70
45	0.70	109	1.71
46	0.71	110	1.73
47	0.73	111	1.75
48	0.75	112	1.76
49	0.76	113	1.78
50	0.78	114	1.79
51	0.79	115	1.81
52	0.81	116	1.83
53	0.83	117	1.84
54	0.84	118	1.86
55	0.86	119	1.87
56	0.87	120	1.89
57	0.89	121	1.90
58	0.90	122	1.92
59	0.92	123	1.94
60	0.94	124	1.95
61	0.95	125	1.97
62	0.97	126	1.98
63	0.98	127	2.00
64	1.00		
65	1.02		
66	1.03		
67	1.05		
68	1.06		
69	1.08		
70	1.10		
71	1.11		
72	1.13		
73	1.14		
74	1.16		
75	1.17		
76	1.19		
77	1.21		

Table #50
Downward Comp Attack

Data	Value	Data	Value
0	0.010ms	64	0.927ms
1	0.011ms	65	0.995ms
2	0.012ms	66	1.068ms
3	0.013ms	67	1.146ms
4	0.014ms	68	1.230ms
5	0.015ms	69	1.320ms
6	0.016ms	70	1.417ms
7	0.017ms	71	1.521ms
8	0.018ms	72	1.632ms
9	0.019ms	73	1.752ms
10	0.020ms	74	1.880ms
11	0.022ms	75	2.018ms
12	0.023ms	76	2.166ms
13	0.025ms	77	2.325ms
14	0.027ms	78	2.496ms
15	0.029ms	79	2.679ms
16	0.031ms	80	2.875ms
17	0.033ms	81	3.086ms
18	0.036ms	82	3.312ms
19	0.038ms	83	3.555ms
20	0.041ms	84	3.816ms
21	0.044ms	85	4.095ms
22	0.047ms	86	4.396ms
23	0.051ms	87	4.718ms
24	0.055ms	88	5.064ms
25	0.059ms	89	5.435ms
26	0.063ms	90	5.834ms
27	0.068ms	91	6.262ms
28	0.073ms	92	6.721ms
29	0.078ms	93	7.214ms
30	0.084ms	94	7.743ms
31	0.090ms	95	8.311ms
32	0.096ms	96	8.920ms
33	0.103ms	97	9.574ms
34	0.111ms	98	10.28ms
35	0.119ms	99	11.03ms
36	0.128ms	100	11.84ms
37	0.137ms	101	12.71ms
38	0.147ms	102	13.64ms
39	0.158ms	103	14.64ms
40	0.170ms	104	15.71ms
41	0.182ms	105	16.86ms
42	0.195ms	106	18.10ms
43	0.210ms	107	19.43ms
44	0.225ms	108	20.85ms
45	0.242ms	109	22.38ms
46	0.259ms	110	24.02ms
47	0.278ms	111	25.79ms
48	0.299ms	112	27.68ms
49	0.321ms	113	29.71ms
50	0.344ms	114	31.88ms
51	0.369ms	115	34.22ms
52	0.396ms	116	36.73ms
53	0.425ms	117	39.42ms
54	0.457ms	118	42.32ms
55	0.490ms	119	45.42ms
56	0.526ms	120	48.75ms
57	0.565ms	121	52.32ms
58	0.606ms	122	56.16ms
59	0.650ms	123	60.28ms
60	0.698ms	124	64.70ms
61	0.749ms	125	69.44ms
62	0.804ms	126	74.53ms
63	0.863ms	127	80.00ms

Table #51
Downward Comp Release

Data	Value	Data	Value
0	6.250ms	64	80.61ms
1	6.505ms	65	83.90ms
2	6.770ms	66	87.32ms
3	7.046ms	67	90.88ms
4	7.333ms	68	94.58ms
5	7.632ms	69	98.44ms
6	7.943ms	70	102.4ms
7	8.267ms	71	106.6ms
8	8.604ms	72	111.0ms
9	8.955ms	73	115.5ms
10	9.320ms	74	120.2ms
11	9.700ms	75	125.1ms
12	10.09ms	76	130.2ms
13	10.51ms	77	135.5ms
14	10.93ms	78	141.0ms
15	11.38ms	79	146.8ms
16	11.84ms	80	152.8ms
17	12.33ms	81	159.0ms
18	12.83ms	82	165.5ms
19	13.35ms	83	172.2ms
20	13.90ms	84	179.2ms
21	14.46ms	85	186.5ms
22	15.05ms	86	194.2ms
23	15.67ms	87	202.1ms
24	16.31ms	88	210.3ms
25	16.97ms	89	218.9ms
26	17.66ms	90	227.8ms
27	18.38ms	91	237.1ms
28	19.13ms	92	246.7ms
29	19.91ms	93	256.8ms
30	20.72ms	94	267.3ms
31	21.57ms	95	278.2ms
32	22.45ms	96	289.5ms
33	23.36ms	97	301.3ms
34	24.31ms	98	313.6ms
35	25.30ms	99	326.4ms
36	26.34ms	100	339.7ms
37	27.41ms	101	353.5ms
38	28.53ms	102	367.9ms
39	29.69ms	103	382.9ms
40	30.90ms	104	398.5ms
41	32.16ms	105	414.8ms
42	33.47ms	106	431.7ms
43	34.83ms	107	449.3ms
44	36.25ms	108	467.6ms
45	37.73ms	109	486.7ms
46	39.27ms	110	506.5ms
47	40.87ms	111	527.2ms
48	42.54ms	112	548.6ms
49	44.27ms	113	571.0ms
50	46.08ms	114	594.3ms
51	47.95ms	115	618.5ms
52	49.91ms	116	643.7ms
53	51.94ms	117	670.0ms
54	54.06ms	118	697.3ms
55	56.26ms	119	725.7ms
56	58.56ms	120	755.3ms
57	60.94ms	121	786.1ms
58	63.43ms	122	818.1ms
59	66.01ms	123	851.4ms
60	68.71ms	124	886.2ms
61	71.51ms	125	922.3ms
62	74.42ms	126	959.9ms
63	77.45ms	127	999.0ms

Table #52
Downward Comp Ratio

Data	Value	Data	Value
0	1.00	64	4.30
1	1.05	65	4.40
2	1.10	66	4.50
3	1.15	67	4.60
4	1.20	68	4.70
5	1.25	69	4.80
6	1.30	70	4.90
7	1.35	71	5.00
8	1.40	72	5.20
9	1.45	73	5.40
10	1.50	74	5.60
11	1.55	75	5.80
12	1.60	76	6.00
13	1.65	77	6.20
14	1.70	78	6.40
15	1.75	79	6.60
16	1.80	80	6.80
17	1.85	81	7.00
18	1.90	82	7.50
19	1.95	83	8.00
20	2.00	84	8.50
21	2.05	85	9.00
22	2.10	86	9.50
23	2.15	87	10.00
24	2.20	88	10.50
25	2.25	89	11.00
26	2.30	90	12.00
27	2.35	91	13.00
28	2.40	92	14.00
29	2.45	93	15.00
30	2.50	94	16.00
31	2.55	95	17.00
32	2.60	96	18.00
33	2.65	97	19.00
34	2.70	98	20.00
35	2.75	99	21.00
36	2.80	100	22.00
37	2.85	101	24.00
38	2.90	102	26.00
39	2.95	103	28.00
40	3.00	104	30.00
41	3.05	105	32.00
42	3.10	106	34.00
43	3.15	107	36.00
44	3.20	108	38.00
45	3.25	109	40.00
46	3.30	110	45.00
47	3.35	111	50.00
48	3.40	112	55.00
49	3.45	113	60.00
50	3.50	114	65.00
51	3.55	115	70.00
52	3.60	116	75.00
53	3.65	117	80.00
54	3.70	118	85.00
55	3.75	119	90.00
56	3.80	120	95.00
57	3.85	121	100.00
58	3.90	122	120.00
59	3.95	123	150.00
60	4.00	124	200.00
61	4.05	125	300.00
62	4.10	126	500.00
63	4.20	127	∞

Table #53
Downward Comp EQ Q

Data	Value	Data	Value
0	0.100	64	1.037
1	0.104	65	1.076
2	0.108	66	1.116
3	0.112	67	1.157
4	0.116	68	1.201
5	0.120	69	1.245
6	0.125	70	1.292
7	0.129	71	1.340
8	0.134	72	1.389
9	0.139	73	1.441
10	0.144	74	1.495
11	0.149	75	1.551
12	0.155	76	1.608
13	0.161	77	1.668
14	0.167	78	1.730
15	0.173	79	1.795
16	0.179	80	1.861
17	0.186	81	1.931
18	0.193	82	2.003
19	0.200	83	2.077
20	0.208	84	2.154
21	0.215	85	2.235
22	0.223	86	2.318
23	0.232	87	2.404
24	0.240	88	2.494
25	0.249	89	2.586
26	0.259	90	2.683
27	0.268	91	2.783
28	0.278	92	2.886
29	0.289	93	2.994
30	0.299	94	3.105
31	0.311	95	3.221
32	0.322	96	3.340
33	0.334	97	3.465
34	0.346	98	3.594
35	0.359	99	3.728
36	0.373	100	3.866
37	0.387	101	4.010
38	0.401	102	4.160
39	0.416	103	4.314
40	0.431	104	4.475
41	0.448	105	4.642
42	0.464	106	4.814
43	0.481	107	4.994
44	0.499	108	5.179
45	0.518	109	5.372
46	0.537	110	5.572
47	0.557	111	5.780
48	0.578	112	5.995
49	0.599	113	6.218
50	0.622	114	6.449
51	0.645	115	6.690
52	0.669	116	6.939
53	0.694	117	7.197
54	0.720	118	7.465
55	0.746	119	7.743
56	0.774	120	8.031
57	0.803	121	8.330
58	0.833	122	8.640
59	0.864	123	8.962
60	0.896	124	9.295
61	0.930	125	9.641
62	0.964	126	10.00
63	1.000		

Table #54
Downward Comp EQ Freq

Data	Value	Data	Value
0	11.89Hz	64	473.2Hz
1	12.59Hz	65	501.2Hz
2	13.34Hz	66	530.9Hz
3	14.13Hz	67	562.3Hz
4	14.96Hz	68	595.7Hz
5	15.85Hz	69	631.0Hz
6	16.79Hz	70	668.3Hz
7	17.78Hz	71	707.9Hz
8	18.84Hz	72	749.9Hz
9	19.95Hz	73	794.3Hz
10	21.13Hz	74	841.4Hz
11	22.39Hz	75	891.3Hz
12	23.71Hz	76	944.1Hz
13	25.12Hz	77	1.000kHz
14	26.61Hz	78	1.059kHz
15	28.18Hz	79	1.122kHz
16	29.85Hz	80	1.189kHz
17	31.62Hz	81	1.259kHz
18	33.50Hz	82	1.334kHz
19	35.48Hz	83	1.413kHz
20	37.58Hz	84	1.496kHz
21	39.81Hz	85	1.585kHz
22	42.17Hz	86	1.679kHz
23	44.67Hz	87	1.778kHz
24	47.32Hz	88	1.884kHz
25	50.12Hz	89	1.995kHz
26	53.09Hz	90	2.113kHz
27	56.23Hz	91	2.239kHz
28	59.57Hz	92	2.371kHz
29	63.10Hz	93	2.512kHz
30	66.83Hz	94	2.661kHz
31	70.79Hz	95	2.818kHz
32	74.99Hz	96	2.985kHz
33	79.43Hz	97	3.162kHz
34	84.14Hz	98	3.350kHz
35	89.13Hz	99	3.548kHz
36	94.41Hz	100	3.758kHz
37	100.0Hz	101	3.981kHz
38	105.9Hz	102	4.217kHz
39	112.2Hz	103	4.467kHz
40	118.9Hz	104	4.732kHz
41	125.9Hz	105	5.012kHz
42	133.4Hz	106	5.309kHz
43	141.3Hz	107	5.623kHz
44	149.6Hz	108	5.957kHz
45	158.5Hz	109	6.310kHz
46	167.9Hz	110	6.683kHz
47	177.8Hz	111	7.079kHz
48	188.4Hz	112	7.499kHz
49	199.5Hz	113	7.943kHz
50	211.3Hz	114	8.414kHz
51	223.9Hz	115	8.913kHz
52	237.1Hz	116	9.441kHz
53	251.2Hz	117	10.00kHz
54	266.1Hz	118	10.59kHz
55	281.8Hz	119	11.22kHz
56	298.5Hz	120	11.89kHz
57	316.2Hz	121	12.59kHz
58	335.0Hz	122	13.34kHz
59	354.8Hz	123	14.13kHz
60	375.8Hz	124	14.96kHz
61	398.1Hz	125	15.85kHz
62	421.7Hz	126	16.79kHz
63	446.7Hz	127	17.78kHz

Table #55
Downward Comp Post HPF

Data	Value	Data	Value
0	Off	64	9.12Hz
1	1.04Hz	65	9.44Hz
2	1.07Hz	66	9.77Hz
3	1.11Hz	67	10.12Hz
4	1.15Hz	68	10.47Hz
5	1.19Hz	69	10.84Hz
6	1.23Hz	70	11.22Hz
7	1.27Hz	71	11.61Hz
8	1.32Hz	72	12.02Hz
9	1.36Hz	73	12.45Hz
10	1.41Hz	74	12.88Hz
11	1.46Hz	75	13.34Hz
12	1.51Hz	76	13.80Hz
13	1.57Hz	77	14.29Hz
14	1.62Hz	78	14.79Hz
15	1.68Hz	79	15.31Hz
16	1.74Hz	80	15.85Hz
17	1.80Hz	81	16.41Hz
18	1.86Hz	82	16.98Hz
19	1.93Hz	83	17.58Hz
20	2.00Hz	84	18.20Hz
21	2.07Hz	85	18.84Hz
22	2.14Hz	86	19.50Hz
23	2.21Hz	87	20.18Hz
24	2.29Hz	88	20.89Hz
25	2.37Hz	89	21.63Hz
26	2.45Hz	90	22.39Hz
27	2.54Hz	91	23.17Hz
28	2.63Hz	92	23.99Hz
29	2.72Hz	93	24.83Hz
30	2.82Hz	94	25.70Hz
31	2.92Hz	95	26.61Hz
32	3.02Hz	96	27.54Hz
33	3.13Hz	97	28.51Hz
34	3.24Hz	98	29.51Hz
35	3.35Hz	99	30.55Hz
36	3.47Hz	100	31.62Hz
37	3.59Hz	101	32.73Hz
38	3.72Hz	102	33.88Hz
39	3.85Hz	103	35.08Hz
40	3.98Hz	104	36.31Hz
41	4.12Hz	105	37.58Hz
42	4.27Hz	106	38.90Hz
43	4.42Hz	107	40.27Hz
44	4.57Hz	108	41.69Hz
45	4.73Hz	109	43.15Hz
46	4.90Hz	110	44.67Hz
47	5.07Hz	111	46.24Hz
48	5.25Hz	112	47.86Hz
49	5.43Hz	113	49.55Hz
50	5.62Hz	114	51.29Hz
51	5.82Hz	115	53.09Hz
52	6.03Hz	116	54.95Hz
53	6.24Hz	117	56.89Hz
54	6.46Hz	118	58.88Hz
55	6.68Hz	119	60.95Hz
56	6.92Hz	120	63.10Hz
57	7.16Hz	121	65.31Hz
58	7.41Hz	122	67.61Hz
59	7.67Hz	123	69.98Hz
60	7.94Hz	124	72.44Hz
61	8.22Hz	125	74.99Hz
62	8.51Hz	126	77.62Hz
63	8.81Hz	127	80.35Hz

Table #56
Rotary Speaker 2 Speed Slow Woofer

Data	Value	Data	Value
0	0.0rpm	64	44.8rpm
1	22.7rpm	65	45.4rpm
2	23.0rpm	66	46.1rpm
3	23.3rpm	67	46.7rpm
4	23.7rpm	68	47.3rpm
5	24.0rpm	69	47.9rpm
6	24.3rpm	70	48.6rpm
7	24.6rpm	71	49.2rpm
8	24.9rpm	72	49.8rpm
9	25.2rpm	73	50.5rpm
10	25.5rpm	74	51.1rpm
11	25.9rpm	75	51.7rpm
12	26.2rpm	76	52.4rpm
13	26.5rpm	77	53.0rpm
14	26.8rpm	78	53.6rpm
15	27.1rpm	79	54.3rpm
16	27.4rpm	80	54.9rpm
17	27.8rpm	81	55.5rpm
18	28.1rpm	82	56.1rpm
19	28.4rpm	83	56.8rpm
20	28.7rpm	84	57.4rpm
21	29.0rpm	85	58.0rpm
22	29.3rpm	86	58.7rpm
23	29.7rpm	87	59.3rpm
24	30.0rpm	88	59.9rpm
25	30.3rpm	89	60.6rpm
26	30.6rpm	90	61.2rpm
27	30.9rpm	91	61.8rpm
28	31.2rpm	92	62.5rpm
29	31.5rpm	93	63.1rpm
30	31.9rpm	94	63.7rpm
31	32.2rpm	95	64.3rpm
32	32.5rpm	96	65.0rpm
33	32.8rpm	97	65.6rpm
34	33.1rpm	98	66.2rpm
35	33.4rpm	99	66.9rpm
36	33.8rpm	100	67.5rpm
37	34.1rpm	101	68.1rpm
38	34.4rpm	102	68.8rpm
39	34.7rpm	103	69.4rpm
40	35.0rpm	104	70.0rpm
41	35.3rpm	105	70.7rpm
42	35.6rpm	106	71.3rpm
43	36.0rpm	107	71.9rpm
44	36.3rpm	108	72.5rpm
45	36.6rpm	109	73.2rpm
46	36.9rpm	110	73.8rpm
47	37.2rpm	111	74.4rpm
48	37.5rpm	112	75.1rpm
49	37.9rpm	113	75.7rpm
50	38.2rpm	114	76.3rpm
51	38.5rpm	115	77.0rpm
52	38.8rpm	116	77.6rpm
53	39.1rpm	117	78.2rpm
54	39.4rpm	118	78.9rpm
55	39.7rpm	119	79.5rpm
56	40.1rpm	120	80.1rpm
57	40.4rpm	121	80.7rpm
58	41.0rpm	122	82.0rpm
59	41.6rpm	123	83.3rpm
60	42.3rpm	124	84.5rpm
61	42.9rpm	125	85.8rpm
62	43.5rpm	126	87.1rpm
63	44.2rpm	127	88.3rpm

Table #57
Rotary Speaker 2 Speed Slow Horn

Data	Value	Data	Value
0	0.0rpm	64	45.4rpm
1	23.0rpm	65	46.1rpm
2	23.3rpm	66	46.7rpm
3	23.7rpm	67	47.3rpm
4	24.0rpm	68	47.9rpm
5	24.3rpm	69	48.6rpm
6	24.6rpm	70	49.2rpm
7	24.9rpm	71	49.8rpm
8	25.2rpm	72	50.5rpm
9	25.5rpm	73	51.1rpm
10	25.9rpm	74	51.7rpm
11	26.2rpm	75	52.4rpm
12	26.5rpm	76	53.0rpm
13	26.8rpm	77	53.6rpm
14	27.1rpm	78	54.3rpm
15	27.4rpm	79	54.9rpm
16	27.8rpm	80	55.5rpm
17	28.1rpm	81	56.1rpm
18	28.4rpm	82	56.8rpm
19	28.7rpm	83	57.4rpm
20	29.0rpm	84	58.0rpm
21	29.3rpm	85	58.7rpm
22	29.7rpm	86	59.3rpm
23	30.0rpm	87	59.9rpm
24	30.3rpm	88	60.6rpm
25	30.6rpm	89	61.2rpm
26	30.9rpm	90	61.8rpm
27	31.2rpm	91	62.5rpm
28	31.5rpm	92	63.1rpm
29	31.9rpm	93	63.7rpm
30	32.2rpm	94	64.3rpm
31	32.5rpm	95	65.0rpm
32	32.8rpm	96	65.6rpm
33	33.1rpm	97	66.2rpm
34	33.4rpm	98	66.9rpm
35	33.8rpm	99	67.5rpm
36	34.1rpm	100	68.1rpm
37	34.4rpm	101	68.8rpm
38	34.7rpm	102	69.4rpm
39	35.0rpm	103	70.0rpm
40	35.3rpm	104	70.7rpm
41	35.6rpm	105	71.3rpm
42	36.0rpm	106	71.9rpm
43	36.3rpm	107	72.5rpm
44	36.6rpm	108	73.2rpm
45	36.9rpm	109	73.8rpm
46	37.2rpm	110	74.4rpm
47	37.5rpm	111	75.1rpm
48	37.9rpm	112	75.7rpm
49	38.2rpm	113	76.3rpm
50	38.5rpm	114	77.0rpm
51	38.8rpm	115	77.6rpm
52	39.1rpm	116	78.2rpm
53	39.4rpm	117	78.9rpm
54	39.7rpm	118	79.5rpm
55	40.1rpm	119	80.1rpm
56	40.4rpm	120	80.7rpm
57	41.0rpm	121	82.0rpm
58	41.6rpm	122	83.3rpm
59	42.3rpm	123	84.5rpm
60	42.9rpm	124	85.8rpm
61	43.5rpm	125	87.1rpm
62	44.2rpm	126	88.3rpm
63	44.8rpm	127	89.6rpm

Table #58
Rotary Speaker 2 Speed Fast Woofer

Data	Value	Data	Value
0	-	64	373.5rpm
1	189.3rpm	65	378.5rpm
2	191.8rpm	66	383.6rpm
3	194.3rpm	67	388.6rpm
4	196.8rpm	68	393.7rpm
5	199.4rpm	69	398.7rpm
6	201.9rpm	70	403.7rpm
7	204.4rpm	71	408.8rpm
8	206.9rpm	72	413.8rpm
9	209.4rpm	73	418.9rpm
10	212.0rpm	74	423.9rpm
11	214.5rpm	75	429.0rpm
12	217.0rpm	76	434.0rpm
13	219.5rpm	77	439.1rpm
14	222.1rpm	78	444.1rpm
15	224.6rpm	79	449.2rpm
16	227.1rpm	80	454.2rpm
17	229.6rpm	81	459.3rpm
18	232.2rpm	82	464.3rpm
19	234.7rpm	83	469.4rpm
20	237.2rpm	84	474.4rpm
21	239.7rpm	85	479.5rpm
22	242.2rpm	86	484.5rpm
23	244.8rpm	87	489.5rpm
24	247.3rpm	88	494.6rpm
25	249.8rpm	89	499.6rpm
26	252.3rpm	90	504.7rpm
27	254.9rpm	91	509.7rpm
28	257.4rpm	92	514.8rpm
29	259.9rpm	93	519.8rpm
30	262.4rpm	94	524.9rpm
31	265.0rpm	95	529.9rpm
32	267.5rpm	96	535.0rpm
33	270.0rpm	97	540.0rpm
34	272.5rpm	98	545.1rpm
35	275.1rpm	99	550.1rpm
36	277.6rpm	100	555.2rpm
37	280.1rpm	101	560.2rpm
38	282.6rpm	102	565.2rpm
39	285.1rpm	103	570.3rpm
40	287.7rpm	104	575.3rpm
41	290.2rpm	105	580.4rpm
42	292.7rpm	106	585.4rpm
43	295.2rpm	107	590.5rpm
44	297.8rpm	108	595.5rpm
45	300.3rpm	109	600.6rpm
46	302.8rpm	110	605.6rpm
47	305.3rpm	111	610.7rpm
48	307.9rpm	112	615.7rpm
49	310.4rpm	113	620.8rpm
50	312.9rpm	114	625.8rpm
51	315.4rpm	115	630.9rpm
52	318.0rpm	116	635.9rpm
53	320.5rpm	117	640.9rpm
54	323.0rpm	118	646.0rpm
55	328.0rpm	119	656.1rpm
56	333.1rpm	120	666.2rpm
57	338.1rpm	121	676.3rpm
58	343.2rpm	122	686.4rpm
59	348.2rpm	123	696.5rpm
60	353.3rpm	124	706.6rpm
61	358.3rpm	125	716.7rpm
62	363.4rpm	126	726.7rpm
63	368.4rpm	127	736.8rpm

Table #59
Rotary Speaker 2 Speed Fast Horn

Data	Value	Data	Value
0	-	64	413.8rpm
1	209.4rpm	65	418.9rpm
2	212.0rpm	66	423.9rpm
3	214.5rpm	67	429.0rpm
4	217.0rpm	68	434.0rpm
5	219.5rpm	69	439.1rpm
6	222.1rpm	70	444.1rpm
7	224.6rpm	71	449.2rpm
8	227.1rpm	72	454.2rpm
9	229.6rpm	73	459.3rpm
10	232.2rpm	74	464.3rpm
11	234.7rpm	75	469.4rpm
12	237.2rpm	76	474.4rpm
13	239.7rpm	77	479.5rpm
14	242.2rpm	78	484.5rpm
15	244.8rpm	79	489.5rpm
16	247.3rpm	80	494.6rpm
17	249.8rpm	81	499.6rpm
18	252.3rpm	82	504.7rpm
19	254.9rpm	83	509.7rpm
20	257.4rpm	84	514.8rpm
21	259.9rpm	85	519.8rpm
22	262.4rpm	86	524.9rpm
23	265.0rpm	87	529.9rpm
24	267.5rpm	88	535.0rpm
25	270.0rpm	89	540.0rpm
26	272.5rpm	90	545.1rpm
27	275.1rpm	91	550.1rpm
28	277.6rpm	92	555.2rpm
29	280.1rpm	93	560.2rpm
30	282.6rpm	94	565.2rpm
31	285.1rpm	95	570.3rpm
32	287.7rpm	96	575.3rpm
33	290.2rpm	97	580.4rpm
34	292.7rpm	98	585.4rpm
35	295.2rpm	99	590.5rpm
36	297.8rpm	100	595.5rpm
37	300.3rpm	101	600.6rpm
38	302.8rpm	102	605.6rpm
39	305.3rpm	103	610.7rpm
40	307.9rpm	104	615.7rpm
41	310.4rpm	105	620.8rpm
42	312.9rpm	106	625.8rpm
43	315.4rpm	107	630.9rpm
44	318.0rpm	108	635.9rpm
45	320.5rpm	109	640.9rpm
46	323.0rpm	110	646.0rpm
47	328.0rpm	111	656.1rpm
48	333.1rpm	112	666.2rpm
49	338.1rpm	113	676.3rpm
50	343.2rpm	114	686.4rpm
51	348.2rpm	115	696.5rpm
52	353.3rpm	116	706.6rpm
53	358.3rpm	117	716.7rpm
54	363.4rpm	118	726.7rpm
55	368.4rpm	119	736.8rpm
56	373.5rpm	120	746.9rpm
57	378.5rpm	121	757.0rpm
58	383.6rpm	122	767.1rpm
59	388.6rpm	123	777.2rpm
60	393.7rpm	124	787.3rpm
61	398.7rpm	125	797.4rpm
62	403.7rpm	126	807.5rpm
63	408.8rpm	127	817.6rpm

Table #60
Reversible LFO Frequency

Data	Value	Data	Value	Data	Value	Data	Value
0	-	64	-2.69Hz	128	0.00Hz	192	2.69Hz
1	-39.7Hz	65	-2.65Hz	129	0.04Hz	193	2.78Hz
2	-37.0Hz	66	-2.61Hz	130	0.08Hz	194	2.86Hz
3	-34.3Hz	67	-2.57Hz	131	0.13Hz	195	2.94Hz
4	-33.0Hz	68	-2.52Hz	132	0.17Hz	196	3.03Hz
5	-31.6Hz	69	-2.48Hz	133	0.21Hz	197	3.11Hz
6	-30.3Hz	70	-2.44Hz	134	0.25Hz	198	3.20Hz
7	-28.9Hz	71	-2.40Hz	135	0.29Hz	199	3.28Hz
8	-27.6Hz	72	-2.36Hz	136	0.34Hz	200	3.37Hz
9	-26.2Hz	73	-2.31Hz	137	0.38Hz	201	3.45Hz
10	-24.9Hz	74	-2.27Hz	138	0.42Hz	202	3.53Hz
11	-23.6Hz	75	-2.23Hz	139	0.46Hz	203	3.62Hz
12	-22.2Hz	76	-2.19Hz	140	0.51Hz	204	3.70Hz
13	-20.9Hz	77	-2.15Hz	141	0.55Hz	205	3.87Hz
14	-19.5Hz	78	-2.10Hz	142	0.59Hz	206	4.04Hz
15	-18.2Hz	79	-2.06Hz	143	0.63Hz	207	4.21Hz
16	-17.5Hz	80	-2.02Hz	144	0.67Hz	208	4.37Hz
17	-16.8Hz	81	-1.98Hz	145	0.72Hz	209	4.54Hz
18	-16.2Hz	82	-1.94Hz	146	0.76Hz	210	4.71Hz
19	-15.5Hz	83	-1.89Hz	147	0.80Hz	211	4.88Hz
20	-14.8Hz	84	-1.85Hz	148	0.84Hz	212	5.05Hz
21	-14.1Hz	85	-1.81Hz	149	0.88Hz	213	5.22Hz
22	-13.5Hz	86	-1.77Hz	150	0.93Hz	214	5.38Hz
23	-12.8Hz	87	-1.72Hz	151	0.97Hz	215	5.55Hz
24	-12.1Hz	88	-1.68Hz	152	1.01Hz	216	5.72Hz
25	-11.4Hz	89	-1.64Hz	153	1.05Hz	217	6.06Hz
26	-10.8Hz	90	-1.60Hz	154	1.09Hz	218	6.39Hz
27	-10.1Hz	91	-1.56Hz	155	1.14Hz	219	6.73Hz
28	-9.76Hz	92	-1.51Hz	156	1.18Hz	220	7.07Hz
29	-9.42Hz	93	-1.47Hz	157	1.22Hz	221	7.40Hz
30	-9.08Hz	94	-1.43Hz	158	1.26Hz	222	7.74Hz
31	-8.75Hz	95	-1.39Hz	159	1.30Hz	223	8.08Hz
32	-8.41Hz	96	-1.35Hz	160	1.35Hz	224	8.41Hz
33	-8.08Hz	97	-1.30Hz	161	1.39Hz	225	8.75Hz
34	-7.74Hz	98	-1.26Hz	162	1.43Hz	226	9.08Hz
35	-7.40Hz	99	-1.22Hz	163	1.47Hz	227	9.42Hz
36	-7.07Hz	100	-1.18Hz	164	1.51Hz	228	9.76Hz
37	-6.73Hz	101	-1.14Hz	165	1.56Hz	229	10.1Hz
38	-6.39Hz	102	-1.09Hz	166	1.60Hz	230	10.8Hz
39	-6.06Hz	103	-1.05Hz	167	1.64Hz	231	11.4Hz
40	-5.72Hz	104	-1.01Hz	168	1.68Hz	232	12.1Hz
41	-5.55Hz	105	-0.97Hz	169	1.72Hz	233	12.8Hz
42	-5.38Hz	106	-0.93Hz	170	1.77Hz	234	13.5Hz
43	-5.22Hz	107	-0.88Hz	171	1.81Hz	235	14.1Hz
44	-5.05Hz	108	-0.84Hz	172	1.85Hz	236	14.8Hz
45	-4.88Hz	109	-0.80Hz	173	1.89Hz	237	15.5Hz
46	-4.71Hz	110	-0.76Hz	174	1.94Hz	238	16.2Hz
47	-4.54Hz	111	-0.72Hz	175	1.98Hz	239	16.8Hz
48	-4.37Hz	112	-0.67Hz	176	2.02Hz	240	17.5Hz
49	-4.21Hz	113	-0.63Hz	177	2.06Hz	241	18.2Hz
50	-4.04Hz	114	-0.59Hz	178	2.10Hz	242	19.5Hz
51	-3.87Hz	115	-0.55Hz	179	2.15Hz	243	20.9Hz
52	-3.70Hz	116	-0.51Hz	180	2.19Hz	244	22.2Hz
53	-3.62Hz	117	-0.46Hz	181	2.23Hz	245	23.6Hz
54	-3.53Hz	118	-0.42Hz	182	2.27Hz	246	24.9Hz
55	-3.45Hz	119	-0.38Hz	183	2.31Hz	247	26.2Hz
56	-3.37Hz	120	-0.34Hz	184	2.36Hz	248	27.6Hz
57	-3.28Hz	121	-0.29Hz	185	2.40Hz	249	28.9Hz
58	-3.20Hz	122	-0.25Hz	186	2.44Hz	250	30.3Hz
59	-3.11Hz	123	-0.21Hz	187	2.48Hz	251	31.6Hz
60	-3.03Hz	124	-0.17Hz	188	2.52Hz	252	33.0Hz
61	-2.94Hz	125	-0.13Hz	189	2.57Hz	253	34.3Hz
62	-2.86Hz	126	-0.08Hz	190	2.61Hz	254	37.0Hz
63	-2.78Hz	127	-0.04Hz	191	2.65Hz	255	39.7Hz

Table #61
LFO Step Transitional Rate

Data	Value
0	1/48
1	3/128
2	1/32
3	1/24
4	3/64
5	1/16
6	1/12
7	3/32
8	1/8
9	1/6
10	3/16
11	1/4
12	1/3
13	3/8
14	1/2

Control List

Controller Box Source

No.	No. (HEX)	Parameter	Short Name	Common	Part
0	0000	Pitch Bend	PitchBend	x	0
1	0001	Modulation Wheel	ModWheel	x	0
2	0002	After Touch	AfterTouch	x	0
3	0003	Foot Controller 1	FootCtrl 1	x	0
4	0004	Foot Controller 2	FootCtrl 2	x	0
5	0005	Foot Switch	FootSwitch	x	0
6	0006	Ribbon Controller	Ribbon	x	0
7	0007	Breath Controller	Breath	x	0
8	0008	Assignable Knob 1	AsgnKnob 1	0	0
9	0009	Assignable Knob 2	AsgnKnob 2	0	0
10	000A	Assignable Knob 3	AsgnKnob 3	0	0
11	000B	Assignable Knob 4	AsgnKnob 4	0	0
12	000C	Assignable Knob 5	AsgnKnob 5	0	0
13	000D	Assignable Knob 6	AsgnKnob 6	0	0
14	000E	Assignable Knob 7	AsgnKnob 7	0	0
15	000F	Assignable Knob 8	AsgnKnob 8	0	0
16	0010	Assignable Switch 1	AsgnSw 1	x	0
17	0011	Assignable Switch 2	AsgnSw 2	x	0
18	0012	Motion Seq 1	MotionSeq 1	0	0
19	0013	Motion Seq 2	MotionSeq 2	0	0
20	0014	Motion Seq 3	MotionSeq 3	0	0
21	0015	Motion Seq 4	MotionSeq 4	0	0
22	0016	Envelope Follower 1	EnvFollow 1	0	0
23	0017	Envelope Follower 2	EnvFollow 2	0	0
24	0018	Envelope Follower 3	EnvFollow 3	0	0
25	0019	Envelope Follower 4	EnvFollow 4	0	0
26	001A	Envelope Follower 5	EnvFollow 5	0	0
27	001B	Envelope Follower 6	EnvFollow 6	0	0
28	001C	Envelope Follower 7	EnvFollow 7	0	0
29	001D	Envelope Follower 8	EnvFollow 8	0	0
30	001E	Envelope Follower 9	EnvFollow 9	0	0
31	001F	Envelope Follower 10	EnvFollow 10	0	0
32	0020	Envelope Follower 11	EnvFollow 11	0	0
33	0021	Envelope Follower 12	EnvFollow 12	0	0
34	0022	Envelope Follower 13	EnvFollow 13	0	0
35	0023	Envelope Follower 14	EnvFollow 14	0	0
36	0024	Envelope Follower 15	EnvFollow 15	0	0
37	0025	Envelope Follower 16	EnvFollow 16	0	0
38	0026	Envelope Follower A/D	EnvFollowAD	0	0
39	0027	Envelope Follower Master	EnvFollowMst	0	0
40	0028	reserved		x	x
41	0029	reserved		x	x

Controller Box Destination

No.	Parameter	Short Name	Multi Part			Audio Part
			AWM Part	AWM Drum	FM Part	
0	Off	Off	0	0	0	0
Common Parameter						
1	Insertion Effect A Parameter 1	InsA Param 1	0	0	0	0
2	Insertion Effect A Parameter 2	InsA Param 2	0	0	0	0
3	Insertion Effect A Parameter 3	InsA Param 3	0	0	0	0
4	Insertion Effect A Parameter 4	InsA Param 4	0	0	0	0
5	Insertion Effect A Parameter 5	InsA Param 5	0	0	0	0
6	Insertion Effect A Parameter 6	InsA Param 6	0	0	0	0
7	Insertion Effect A Parameter 7	InsA Param 7	0	0	0	0
8	Insertion Effect A Parameter 8	InsA Param 8	0	0	0	0
9	Insertion Effect A Parameter 9	InsA Param 9	0	0	0	0
10	Insertion Effect A Parameter 10	InsA Param 10	0	0	0	0
11	Insertion Effect A Parameter 11	InsA Param 11	0	0	0	0
12	Insertion Effect A Parameter 12	InsA Param 12	0	0	0	0
13	Insertion Effect A Parameter 13	InsA Param 13	0	0	0	0
14	Insertion Effect A Parameter 14	InsA Param 14	0	0	0	0
15	Insertion Effect A Parameter 15	InsA Param 15	0	0	0	0
16	Insertion Effect A Parameter 16	InsA Param 16	0	0	0	0
17	Insertion Effect A Parameter 17	InsA Param 17	0	0	0	0
18	Insertion Effect A Parameter 18	InsA Param 18	0	0	0	0
19	Insertion Effect A Parameter 19	InsA Param 19	0	0	0	0
20	Insertion Effect A Parameter 20	InsA Param 20	0	0	0	0
21	Insertion Effect A Parameter 21	InsA Param 21	0	0	0	0
22	Insertion Effect A Parameter 22	InsA Param 22	0	0	0	0
23	Insertion Effect A Parameter 23	InsA Param 23	0	0	0	0
24	Insertion Effect A Parameter 24	InsA Param 24	0	0	0	0
25	Insertion Effect B Parameter 1	InsB Param 1	0	0	0	0
26	Insertion Effect B Parameter 2	InsB Param 2	0	0	0	0
27	Insertion Effect B Parameter 3	InsB Param 3	0	0	0	0
28	Insertion Effect B Parameter 4	InsB Param 4	0	0	0	0
29	Insertion Effect B Parameter 5	InsB Param 5	0	0	0	0
30	Insertion Effect B Parameter 6	InsB Param 6	0	0	0	0
31	Insertion Effect B Parameter 7	InsB Param 7	0	0	0	0
32	Insertion Effect B Parameter 8	InsB Param 8	0	0	0	0
33	Insertion Effect B Parameter 9	InsB Param 9	0	0	0	0
34	Insertion Effect B Parameter 10	InsB Param 10	0	0	0	0
35	Insertion Effect B Parameter 11	InsB Param 11	0	0	0	0
36	Insertion Effect B Parameter 12	InsB Param 12	0	0	0	0
37	Insertion Effect B Parameter 13	InsB Param 13	0	0	0	0
38	Insertion Effect B Parameter 14	InsB Param 14	0	0	0	0
39	Insertion Effect B Parameter 15	InsB Param 15	0	0	0	0
40	Insertion Effect B Parameter 16	InsB Param 16	0	0	0	0
41	Insertion Effect B Parameter 17	InsB Param 17	0	0	0	0
42	Insertion Effect B Parameter 18	InsB Param 18	0	0	0	0
43	Insertion Effect B Parameter 19	InsB Param 19	0	0	0	0
44	Insertion Effect B Parameter 20	InsB Param 20	0	0	0	0
45	Insertion Effect B Parameter 21	InsB Param 21	0	0	0	0
46	Insertion Effect B Parameter 22	InsB Param 22	0	0	0	0
47	Insertion Effect B Parameter 23	InsB Param 23	0	0	0	0
48	Insertion Effect B Parameter 24	InsB Param 24	0	0	0	0
49	Part Reverb Send	Rev Send	0	0	0	x
50	Part Variation Send	Var Send	0	0	0	x
51	Part Portamento Time	Porta Time	0	x	0	x
52	Part Mono/Poly	Mono/Poly	0	x	0	x
53	Pitch	Pitch	0	x	0	x
54	Part Volume	Volume	0	0	0	x
55	Part LFO Speed	PLFO Speed	0	x	0	x
56	Part LFO Destination 1 Depth	PLFO Depth 1	0	x	0	x
57	Part LFO Destination 2 Depth	PLFO Depth 2	0	x	0	x
58	Part LFO Destination 3 Depth	PLFO Depth 3	0	x	0	x
AWM Parameter						
59	Element Level	Elem Level	0	x	x	x
60	Element Pan	Elem Pan	0	x	x	x
61	Element Key On Delay Time	Elem Delay	0	x	x	x
62	Element LFO Speed	E.LFO Speed	0	x	x	x
63	Element LFO PMD	E.LFO PMD	0	x	x	x
64	Element LFO AMD	E.LFO AMD	0	x	x	x
65	Element LFO FMD	E.LFO FMD	0	x	x	x
66	Element Coarse Tune	Coarse	0	x	x	x
67	Element Fine Tune	Fine	0	x	x	x
68	Element PEG Depth	PEG Depth	0	x	x	x
69	Element PEG Hold Time	PEG Hold	0	x	x	x











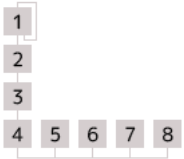
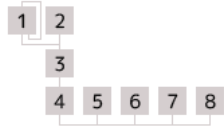
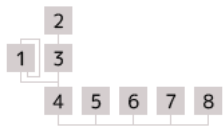
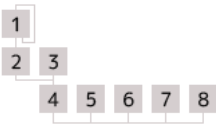

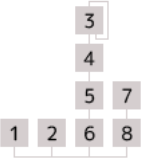

No.	Parameter	Short Name	Multi Part			Audio Part
			AWM Part	AWM Drum	FM Part	
70	Element PEG Attack Time	PEG Attack	0	x	x	x
71	Element PEG Decay 1 Time	PEG Decay 1	0	x	x	x
72	Element PEG Decay 2 Time	PEG Decay 2	0	x	x	x
73	Element PEG Release Time	PEG Release	0	x	x	x
74	Element AEG Attack Time	AEG Attack	0	x	x	x
75	Element AEG Decay 1 Time	AEG Decay 1	0	x	x	x
76	Element AEG Decay 2 Time	AEG Decay 2	0	x	x	x
77	Element AEG Release Time	AEG Release	0	x	x	x
78	Element FEG Depth	FEG Depth	0	x	x	x
79	Element FEG Hold Time	FEG Hold	0	x	x	x
80	Element FEG Attack Time	FEG Attack	0	x	x	x
81	Element FEG Decay 1 Time	FEG Decay 1	0	x	x	x
82	Element FEG Decay 2 Time	FEG Decay 2	0	x	x	x
83	Element FEG Release Time	FEG Release	0	x	x	x
84	Element Cutoff Frequency	Cutoff	0	x	x	x
85	Element Resonance	Resonance	0	x	x	x
86	Element HPF Cutoff Frequency	HPF Cutoff	0	x	x	x
FM Parameter						
87	Pan	Pan	x	x	0	x
88	LFO Speed	LFO2 Speed	x	x	0	x
89	LFO PMD	LFO2 PMD	x	x	0	x
90	LFO AMD	LFO2 AMD	x	x	0	x
91	LFO FMD	LFO2 FMD	x	x	0	x
92	PEG Attack Time	PEG Attack	x	x	0	x
93	PEG Release Time	PEG Release	x	x	0	x
94	AEG Attack Time	AEG Attack	x	x	0	x
95	AEG Decay 1&2 Time	AEG Decay 1&2	x	x	0	x
96	AEG Release Time	AEG Release	x	x	0	x
97	FEG Depth	FEG Depth	x	x	0	x
98	FEG Attack Time	FEG Attack	x	x	0	x
99	FEG Decay 1&2 Time	FEG Decay 1&2	x	x	0	x
100	FEG Release Time	FEG Release	x	x	0	x
101	Filter Cutoff Frequency	Cutoff	x	x	0	x
102	Filter Resonance	Resonance	x	x	0	x
103	Feedback	Feedback	x	x	0	x
104	OP1 - 8 Frequency	OP Freq	x	x	0	x
105	OP1 - 8 Output Level	OP Level	x	x	0	x
106	OP1 - 8 Spectral Form	OP Spectral	x	x	0	x
107	OP1 - 8 Spectral Skirt	OP Skirt	x	x	0	x
108	OP1 - 8 Spectral Resonance	OP Resonance	x	x	0	x
109	OP1 - 8 Detune	OP Detune	x	x	0	x
110	OP1 - 8 EG Level Offset	OP AEG Offset	x	x	0	x
111	OP1 - 8 EG Time1	OP AEG Attack	x	x	0	x
112	OP1 - 8 EG Time2	OP AEG Decay1	x	x	0	x
113	OP1 - 8 EG Time3	OP AEG Decay2	x	x	0	x
114	OP1 - 8 EG Time4	OP AEG Release	x	x	0	x
115	OP1 - 8 Pitch EG Attack Time	OP PEG Attack	x	x	0	x
116	OP1 - 8 Pitch EG Decay Time	OP PEG Decay	x	x	0	x
System Parameter						
49	Reverb Effect Parameter 1	Rev Param 1	x	x	x	0
50	Reverb Effect Parameter 2	Rev Param 2	x	x	x	0
51	Reverb Effect Parameter 3	Rev Param 3	x	x	x	0
52	Reverb Effect Parameter 4	Rev Param 4	x	x	x	0
53	Reverb Effect Parameter 5	Rev Param 5	x	x	x	0
54	Reverb Effect Parameter 6	Rev Param 6	x	x	x	0
55	Reverb Effect Parameter 7	Rev Param 7	x	x	x	0
56	Reverb Effect Parameter 8	Rev Param 8	x	x	x	0
57	Reverb Effect Parameter 9	Rev Param 9	x	x	x	0
58	Reverb Effect Parameter 10	Rev Param 10	x	x	x	0
59	Reverb Effect Parameter 11	Rev Param 11	x	x	x	0
60	Reverb Effect Parameter 12	Rev Param 12	x	x	x	0
61	Reverb Effect Parameter 13	Rev Param 13	x	x	x	0
62	Reverb Effect Parameter 14	Rev Param 14	x	x	x	0
63	Reverb Effect Parameter 15	Rev Param 15	x	x	x	0
64	Reverb Effect Parameter 16	Rev Param 16	x	x	x	0
65	Reverb Effect Parameter 17	Rev Param 17	x	x	x	0
66	Reverb Effect Parameter 18	Rev Param 18	x	x	x	0
67	Reverb Effect Parameter 19	Rev Param 19	x	x	x	0
68	Reverb Effect Parameter 20	Rev Param 20	x	x	x	0
69	Reverb Effect Parameter 21	Rev Param 21	x	x	x	0
70	Reverb Effect Parameter 22	Rev Param 22	x	x	x	0
71	Reverb Effect Parameter 23	Rev Param 23	x	x	x	0

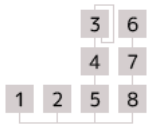
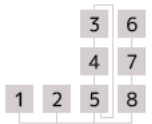

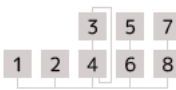
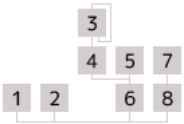
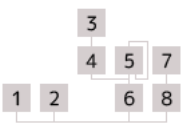
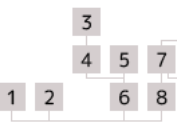

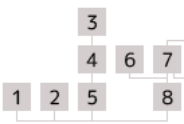

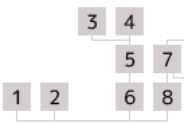
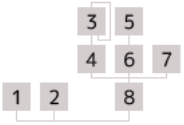

No.	Parameter	Short Name	Multi Part			Audio Part
			AWM Part	AWM Drum	FM Part	
72	Reverb Effect Parameter 24	Rev Param 24	x	x	x	0
73	Variation Effect Parameter 1	Var Param 1	x	x	x	0
74	Variation Effect Parameter 2	Var Param 2	x	x	x	0
75	Variation Effect Parameter 3	Var Param 3	x	x	x	0
76	Variation Effect Parameter 4	Var Param 4	x	x	x	0
77	Variation Effect Parameter 5	Var Param 5	x	x	x	0
78	Variation Effect Parameter 6	Var Param 6	x	x	x	0
79	Variation Effect Parameter 7	Var Param 7	x	x	x	0
80	Variation Effect Parameter 8	Var Param 8	x	x	x	0
81	Variation Effect Parameter 9	Var Param 9	x	x	x	0
82	Variation Effect Parameter 10	Var Param 10	x	x	x	0
83	Variation Effect Parameter 11	Var Param 11	x	x	x	0
84	Variation Effect Parameter 12	Var Param 12	x	x	x	0
85	Variation Effect Parameter 13	Var Param 13	x	x	x	0
86	Variation Effect Parameter 14	Var Param 14	x	x	x	0
87	Variation Effect Parameter 15	Var Param 15	x	x	x	0
88	Variation Effect Parameter 16	Var Param 16	x	x	x	0
89	Variation Effect Parameter 17	Var Param 17	x	x	x	0
90	Variation Effect Parameter 18	Var Param 18	x	x	x	0
91	Variation Effect Parameter 19	Var Param 19	x	x	x	0
92	Variation Effect Parameter 20	Var Param 20	x	x	x	0
93	Variation Effect Parameter 21	Var Param 21	x	x	x	0
94	Variation Effect Parameter 22	Var Param 22	x	x	x	0
95	Variation Effect Parameter 23	Var Param 23	x	x	x	0
96	Variation Effect Parameter 24	Var Param 24	x	x	x	0
97	Master Effect Parameter 1	Mfx Param 1	x	x	x	0
98	Master Effect Parameter 2	Mfx Param 2	x	x	x	0
99	Master Effect Parameter 3	Mfx Param 3	x	x	x	0
100	Master Effect Parameter 4	Mfx Param 4	x	x	x	0
101	Master Effect Parameter 5	Mfx Param 5	x	x	x	0
102	Master Effect Parameter 6	Mfx Param 6	x	x	x	0
103	Master Effect Parameter 7	Mfx Param 7	x	x	x	0
104	Master Effect Parameter 8	Mfx Param 8	x	x	x	0
105	Master Effect Parameter 9	Mfx Param 9	x	x	x	0
106	Master Effect Parameter 10	Mfx Param 10	x	x	x	0
107	Master Effect Parameter 11	Mfx Param 11	x	x	x	0
108	Master Effect Parameter 12	Mfx Param 12	x	x	x	0
109	Master Effect Parameter 13	Mfx Param 13	x	x	x	0
110	Master Effect Parameter 14	Mfx Param 14	x	x	x	0
111	Master Effect Parameter 15	Mfx Param 15	x	x	x	0
112	Master Effect Parameter 16	Mfx Param 16	x	x	x	0
113	Master Effect Parameter 17	Mfx Param 17	x	x	x	0
114	Master Effect Parameter 18	Mfx Param 18	x	x	x	0
115	Master Effect Parameter 19	Mfx Param 19	x	x	x	0
116	Master Effect Parameter 20	Mfx Param 20	x	x	x	0
117	Master Effect Parameter 21	Mfx Param 21	x	x	x	0
118	Master Effect Parameter 22	Mfx Param 22	x	x	x	0
119	Master Effect Parameter 23	Mfx Param 23	x	x	x	0
120	Master Effect Parameter 24	Mfx Param 24	x	x	x	0
AD Parameter						
121	Part Volume	AD Volume	x	x	x	0
122	Part Reverb Send	AD Rev Send	x	x	x	0
123	Part Variation Send	AD Var Send	x	x	x	0
Part Assignable Knob						
124	Part 1 Assignable Knob 1	Part 1 Assign 1	x	x	x	0
125	Part 1 Assignable Knob 2	Part 1 Assign 2	x	x	x	0
126	Part 1 Assignable Knob 3	Part 1 Assign 3	x	x	x	0
127	Part 1 Assignable Knob 4	Part 1 Assign 4	x	x	x	0
128	Part 1 Assignable Knob 5	Part 1 Assign 5	x	x	x	0
129	Part 1 Assignable Knob 6	Part 1 Assign 6	x	x	x	0
130	Part 1 Assignable Knob 7	Part 1 Assign 7	x	x	x	0
131	Part 1 Assignable Knob 8	Part 1 Assign 8	x	x	x	0
132	Part 2 Assignable Knob 1	Part 2 Assign 1	x	x	x	0
133	Part 2 Assignable Knob 2	Part 2 Assign 2	x	x	x	0
134	Part 2 Assignable Knob 3	Part 2 Assign 3	x	x	x	0
135	Part 2 Assignable Knob 4	Part 2 Assign 4	x	x	x	0
136	Part 2 Assignable Knob 5	Part 2 Assign 5	x	x	x	0
137	Part 2 Assignable Knob 6	Part 2 Assign 6	x	x	x	0
138	Part 2 Assignable Knob 7	Part 2 Assign 7	x	x	x	0
139	Part 2 Assignable Knob 8	Part 2 Assign 8	x	x	x	0
140	Part 3 Assignable Knob 1	Part 3 Assign 1	x	x	x	0
141	Part 3 Assignable Knob 2	Part 3 Assign 2	x	x	x	0

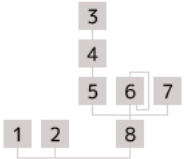
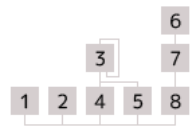
LFO Box Destination

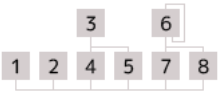
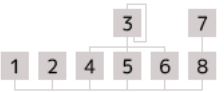
No.	Parameter	Short Name	Multi Part			Audio Part
			AWM Part	AWM Drum	FM Part	
Common Parameter						
0	Insertion Effect A Parameter 1	InsA Param 1	0	x	0	-
1	Insertion Effect A Parameter 2	InsA Param 2	0	x	0	-
2	Insertion Effect A Parameter 3	InsA Param 3	0	x	0	-
3	Insertion Effect A Parameter 4	InsA Param 4	0	x	0	-
4	Insertion Effect A Parameter 5	InsA Param 5	0	x	0	-
5	Insertion Effect A Parameter 6	InsA Param 6	0	x	0	-
6	Insertion Effect A Parameter 7	InsA Param 7	0	x	0	-
7	Insertion Effect A Parameter 8	InsA Param 8	0	x	0	-
8	Insertion Effect A Parameter 9	InsA Param 9	0	x	0	-
9	Insertion Effect A Parameter 10	InsA Param 10	0	x	0	-
10	Insertion Effect A Parameter 11	InsA Param 11	0	x	0	-
11	Insertion Effect A Parameter 12	InsA Param 12	0	x	0	-
12	Insertion Effect A Parameter 13	InsA Param 13	0	x	0	-
13	Insertion Effect A Parameter 14	InsA Param 14	0	x	0	-
14	Insertion Effect A Parameter 15	InsA Param 15	0	x	0	-
15	Insertion Effect A Parameter 16	InsA Param 16	0	x	0	-
16	Insertion Effect A Parameter 17	InsA Param 17	0	x	0	-
17	Insertion Effect A Parameter 18	InsA Param 18	0	x	0	-
18	Insertion Effect A Parameter 19	InsA Param 19	0	x	0	-
19	Insertion Effect A Parameter 20	InsA Param 20	0	x	0	-
20	Insertion Effect A Parameter 21	InsA Param 21	0	x	0	-
21	Insertion Effect A Parameter 22	InsA Param 22	0	x	0	-
22	Insertion Effect A Parameter 23	InsA Param 23	0	x	0	-
23	Insertion Effect A Parameter 24	InsA Param 24	0	x	0	-
24	reserved		x	x	x	-
25	reserved		x	x	x	-
26	reserved		x	x	x	-
27	reserved		x	x	x	-
28	reserved		x	x	x	-
29	reserved		x	x	x	-
30	reserved		x	x	x	-
31	reserved		x	x	x	-
32	Insertion Effect B Parameter 1	InsB Param 1	0	x	0	-
33	Insertion Effect B Parameter 2	InsB Param 2	0	x	0	-
34	Insertion Effect B Parameter 3	InsB Param 3	0	x	0	-
35	Insertion Effect B Parameter 4	InsB Param 4	0	x	0	-
36	Insertion Effect B Parameter 5	InsB Param 5	0	x	0	-
37	Insertion Effect B Parameter 6	InsB Param 6	0	x	0	-
38	Insertion Effect B Parameter 7	InsB Param 7	0	x	0	-
39	Insertion Effect B Parameter 8	InsB Param 8	0	x	0	-
40	Insertion Effect B Parameter 9	InsB Param 9	0	x	0	-
41	Insertion Effect B Parameter 10	InsB Param 10	0	x	0	-
42	Insertion Effect B Parameter 11	InsB Param 11	0	x	0	-
43	Insertion Effect B Parameter 12	InsB Param 12	0	x	0	-
44	Insertion Effect B Parameter 13	InsB Param 13	0	x	0	-
45	Insertion Effect B Parameter 14	InsB Param 14	0	x	0	-
46	Insertion Effect B Parameter 15	InsB Param 15	0	x	0	-
47	Insertion Effect B Parameter 16	InsB Param 16	0	x	0	-
48	Insertion Effect B Parameter 17	InsB Param 17	0	x	0	-
49	Insertion Effect B Parameter 18	InsB Param 18	0	x	0	-
50	Insertion Effect B Parameter 19	InsB Param 19	0	x	0	-
51	Insertion Effect B Parameter 20	InsB Param 20	0	x	0	-
52	Insertion Effect B Parameter 21	InsB Param 21	0	x	0	-
53	Insertion Effect B Parameter 22	InsB Param 22	0	x	0	-
54	Insertion Effect B Parameter 23	InsB Param 23	0	x	0	-
55	Insertion Effect B Parameter 24	InsB Param 24	0	x	0	-
56	reserved		x	x	x	-
57	reserved		x	x	x	-
58	reserved		x	x	x	-
59	reserved		x	x	x	-
60	reserved		x	x	x	-
61	reserved		x	x	x	-
62	reserved		x	x	x	-
63	reserved		x	x	x	-
AWM Parameter						
64	Element Level	Level	0	x	x	-
65	Element Pitch	Pitch	0	x	x	-
66	Element Filter Cutoff	Cutoff	0	x	x	-
67	Element Filter Resonance/Width	Resonance	0	x	x	-
68	Element Pan	Pan	0	x	x	-
69	Element LFO Speed	E.LFO Speed	0	x	x	-

Algorithm Chart

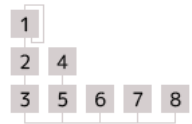
			
1	2	3	4
			
5	6	7	8
			
9	10	11	12
			
13	14	15	16
			
17	18	19	20
			
21	22	23	24

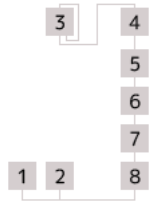
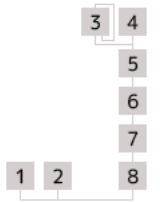
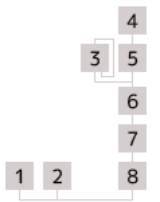
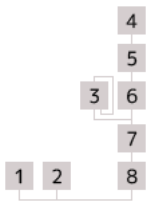
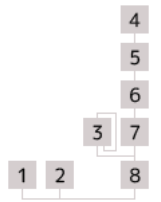
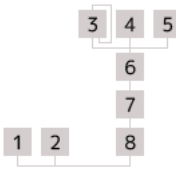
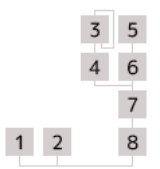
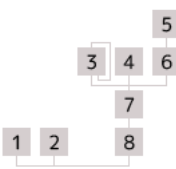
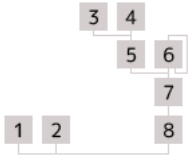
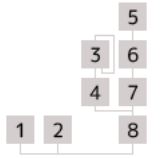
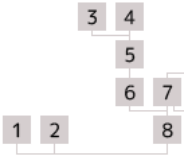
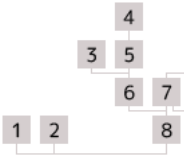
			
25	26	27	28
			
29	30	31	32
			
33	34	35	36
			
37	38	39	40
			
41	42	43	44
			
45	46	47	48

49	50	51	52
53	54	55	56
57	58	59	60
61	62	63	64
65	66	67	68
69	70	71	72

73	74	75	76
77	78	79	80
81	82	83	84
85	86	87	88

MIDI Data Format

Many MIDI messages listed in the MIDI Data Format section are expressed in hexadecimal or binary numbers. Hexadecimal numbers may include the letter "H" as a suffix. The letter "n" indicates a certain whole number.

The chart below lists the corresponding decimal number for each hexadecimal number.

Decimal	Hexadecimal	Decimal	Hexadecimal
0	0	64	40
1	1	65	41
2	2	66	42
3	3	67	43
4	4	68	44
5	5	69	45
6	6	70	46
7	7	71	47
8	8	72	48
9	9	73	49
10	0A	74	4A
11	0B	75	4B
12	0C	76	4C
13	0D	77	4D
14	0E	78	4E
15	0F	79	4F
16	10	80	50
17	11	81	51
18	12	82	52
19	13	83	53
20	14	84	54
21	15	85	55
22	16	86	56
23	17	87	57
24	18	88	58
25	19	89	59
26	1A	90	5A
27	1B	91	5B
28	1C	92	5C
29	1D	93	5D
30	1E	94	5E
31	1F	95	5F
32	20	96	60
33	21	97	61
34	22	98	62
35	23	99	63
36	24	100	64
37	25	101	65
38	26	102	66
39	27	103	67
40	28	104	68
41	29	105	69
42	2A	106	6A
43	2B	107	6B
44	2C	108	6C
45	2D	109	6D
46	2E	110	6E
47	2F	111	6F
48	30	112	70
49	31	113	71
50	32	114	72
51	33	115	73
52	34	116	74
53	35	117	75
54	36	118	76
55	37	119	77
56	38	120	78
57	39	121	79
58	3A	122	7A
59	3B	123	7B
60	3C	124	7C
61	3D	125	7D
62	3E	126	7E
63	3F	127	7F

Additional Notes

- For example, 144 – 159(Decimal)/9nH/1001 0000 – 1001 1111(Binary) indicate the note-on messages for the channels 1 through 16 respectively. 176 – 191/BnH/1011 0000 – 1011 1111 indicate the control change messages for the channels 1 through 16 respectively. 192 – 207/CnH/1100 0000 – 1100 1111 indicate the program change messages for the channels 1 through 16 respectively. 240/F0H/1111 0000 is positioned at the beginning of data to indicate a system exclusive message. 247/F7H/1111 0111 is positioned at the end of the system exclusive message.
- aaH (Hexadecimal)/0aaaaaaa (Binary) indicates the data addresses. The data address consists of High, Mid and Low.
- bbH/0bbbbbbb indicates byte counts.
- ccH/0ccccccc indicates check sums.
- ddH/0ddddddd indicates data/value.

SYNTHSIZER/SEQUENCER PART

(1) TRANSMIT FLOW

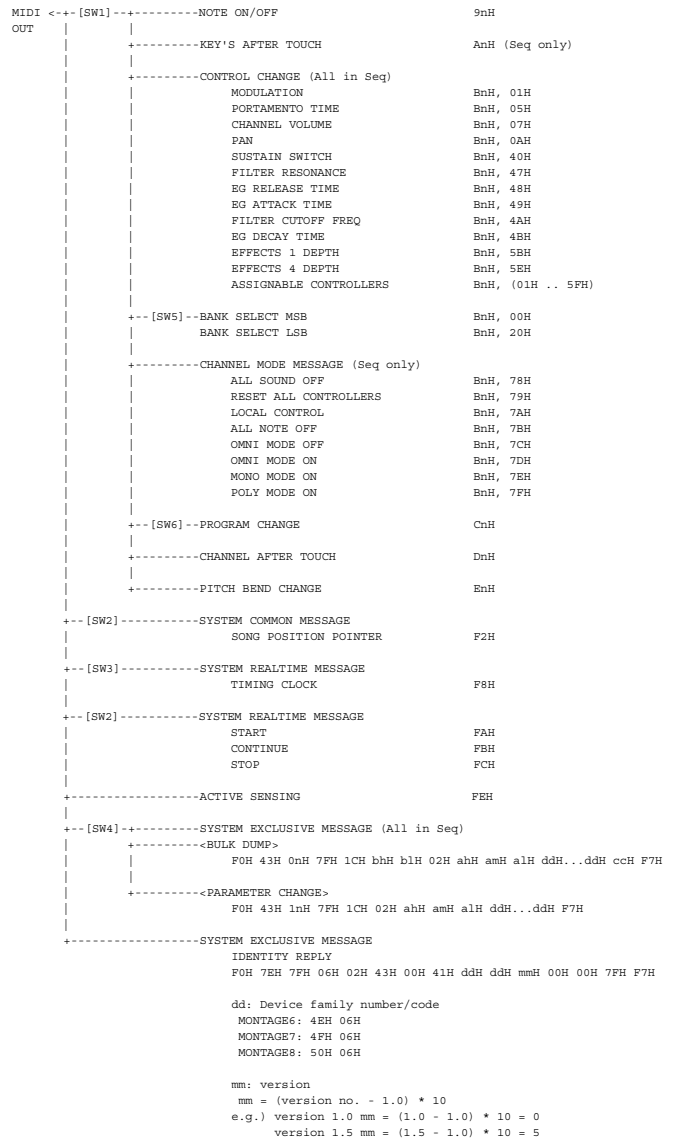

- [SW1] MIDI Transmit Channel
Complies with Zone Transmit Channel when the Part Zone Switch is set to on.
Complies with Part number in any other case.
- [SW2] SYSTEM Song Play/Stop Transmit Switch
- [SW3] SYSTEM MIDI Clock Out
- [SW4] SYSTEM MIDI Device Number
When set to all, transmitted via 1.
- [SW5] SYSTEM Bank Select Switch
- [SW6] SYSTEM Program Change Switch

(2) RECEIVE FLOW

MIDI>--	[SW1]	-----NOTE OFF	8nH
		-----NOTE ON/OFF	9nH
		-----KEY'S AFTER TOUCH	AnH (Seq only)
		-----CONTROL CHANGE (All in Seq)	
		MODULATION	BnH, 01H
		PORTAMENTO TIME	BnH, 05H
		DATA ENTRY MSB	BnH, 06H
		DATA ENTRY LSB	BnH, 26H
		CHANNEL VOLUME	BnH, 07H
		PAN	BnH, 0AH
		EXPRESSION	BnH, 0BH
		SUSTAIN SWITCH	BnH, 40H
		PORTAMENTO SWITCH	BnH, 41H
		SOSTENUTO	BnH, 42H
		HARMONIC CONTENT	BnH, 47H
		EG RELEASE TIME	BnH, 48H
		EG ATTACK TIME	BnH, 49H
		BRIGHTNESS	BnH, 4AH
		EG DECAY TIME	BnH, 4BH
		EFFECTS 1 DEPTH	BnH, 5BH
		EFFECTS 4 DEPTH	BnH, 5EH
		DATA ENTRY INC	BnH, 60H
		DATA ENTRY DEC	BnH, 61H
		ASSIGNABLE CONTROLLER	BnH, (01H .. 5FH)
		RPN	
		PITCH BEND SENS.	BnH, 64H, 00H, 65H, 00H, 06H, mmH
		FINE TUNING	BnH, 64H, 01H, 65H, 00H, 06H, mmH, 26H, 11H
		COARSE TUNING	BnH, 64H, 02H, 65H, 00H, 06H, mmH
		RPN RESET	BnH, 64H, 7FH, 65H, 7FH
	[SW6]	--BANK SELECT MSB	BnH, 00H
		BANK SELECT LSB	BnH, 20H
		-----CHANNEL MODE MESSAGE	
		ALL SOUND OFF	BnH, 78H
		RESET ALL CONTROLLERS	BnH, 79H
		ALL NOTE OFF	BnH, 7BH
		OMNI MODE OFF	BnH, 7CH
		OMNI MODE ON	BnH, 7DH
		MONO MODE ON	BnH, 7EH
		POLY MODE ON	BnH, 7FH
	[SW7]	--PROGRAM CHANGE	CnH
		-----CHANNEL AFTER TOUCH	DnH
		-----PITCH BEND CHANGE	EnH
	[SW3]	-----SYSTEM COMMON MESSAGE	
		SONG POSITION POINTER	F2H
	[SW2]	-----SYSTEM REALTIME MESSAGE	
		TIMING CLOCK	F8H
	[SW3]	-----SYSTEM REALTIME MESSAGE	
		START	FAH
		CONTINUE	FBH
		STOP	FCH
		-----ACTIVE SENSING	FEH
	[SW4]	-----SYSTEM EXCLUSIVE MESSAGE (All in Seq)	
		MIDI MASTER VOLUME	FOH 7FH 7FH 04H 01H 11H mmH F7H
		<<BULK DUMP>>	FOH 43H 0nH 7FH 1CH bhH b1H 02H ahH amH alH ddH...ddH cch F7H
		<<PARAMETER CHANGE>>	FOH 43H 1nH 7FH 1CH 02H ahH amH alH ddH...ddH F7H
		<<BULK DUMP REQUEST>>	FOH 43H 2nH 7FH 1CH 02H ahH amH alH ddH...ddH F7H
		<<PARAMETER REQUEST>>	FOH 43H 3nH 7FH 1CH 02H ahH amH alH F7H
		GM MODE ON	FOH 7EH 7FH 09H 01H F7H
		-----SYSTEM EXCLUSIVE MESSAGE	
		IDENTITY REQUEST	FOH 7EH 0nH 06H 01H F7H

- [SW1] Complies with Part Receive Switch.
The MIDI Receive Channel complies with the Part number.
- [SW2] SYSTEM MIDI Sync for determining whether internal Clock or MIDI Clock is used as Timing Clock.
- [SW3] SYSTEM Sequencer Control
- [SW4] SYSTEM MIDI Device Number
When this is not set to off, the MIDI Master Volume can be recognized in any mode.
- [SW5] SYSTEM Bulk Receive Switch
- [SW6] SYSTEM Bank Select Switch
- [SW7] SYSTEM Program Change Switch

(3) TRANSMIT/RECEIVE DATA

(3-1) CHANNEL VOICE MESSAGES

(3-1-1) NOTE OFF

STATUS	100nnnn (8nH)	n = 0 - 15 CHANNEL NUMBER
NOTE No.	0kkkkkkk	k = 0 (C-2) - 127 (G8)
VELOCITY	0vvvvvvv	v: ignored
Receive only		

(3-1-2) NOTE ON/OFF

STATUS	1001nnnn (9nH)	n = 0 - 15 CHANNEL NUMBER
NOTE NUMBER	0kkkkkkk	k = 0 (C-2) - 127 (G8)
VELOCITY NOTE ON	0vvvvvvv (v≠0)	
NOTE OFF	0vvvvvvv (v=0)	

(3-1-3) CONTROL CHANGE

STATUS	1011nnnn (BnH)	n = 0 - 15 CHANNEL NUMBER
CONTROL NUMBER	0ccccccc	
CONTROL VALUE	0vvvvvvv	

*TRANSMITTED CONTROL NUMBER

c = 0	BANK SELECT MSB	; v = 0 - 127	*3
c = 32	BANK SELECT LSB	; v = 0 - 127	*3
c = 1	MODULATION	; v = 0 - 127	
c = 5	PORTAMENTO TIME	; v = 0 - 127	
c = 7	CHANNEL VOLUME	; v = 0 - 127	
c = 10	PAN	; v = 0 - 127	
c = 64	SUSTAIN SWITCH	; v = 0 - 127	*5
c = 71	FILTER RESONANCE	; v = 0: -64 - 64: 0 - 127: +63	
c = 72	EG RELEASE TIME	; v = 0: -64 - 64: 0 - 127: +63	
c = 73	EG ATTACK TIME	; v = 0: -64 - 64: 0 - 127: +63	
c = 74	FILTER CUTOFF FREQ	; v = 0: -64 - 64: 0 - 127: +63	
c = 75	EG DECAY TIME	; v = 0: -64 - 64: 0 - 127: +63	
c = 91	EFFECTS 1 DEPTH	; v = 0 - 127	
c = 94	EFFECTS 4 DEPTH	; v = 0 - 127	
c = 1..95	ASSIGNABLE CONTROLLER	; v = 0 - 127	*4

The Sequencer Part will play back all recorded control change messages.

* RECEIVED CONTROL NUMBER

c = 0	BANK SELECT MSB	; v = 0 - 127	*3
c = 32	BANK SELECT LSB	; v = 0 - 127	*3
c = 1	MODULATION	; v = 0 - 127	
c = 5	PORTAMENTO TIME	; v = 0 - 127	*2
c = 6	DATA ENTRY MSB	; v = 0 - 127	*1
c = 38	DATA ENTRY LSB	; v = 0 - 127	*1
c = 7	CHANNEL VOLUME	; v = 0 - 127	
c = 10	PAN	; v = 0 - 127	
c = 11	EXPRESSION	; v = 0 - 127	
c = 64	SUSTAIN SWITCH	; v = 0 - 127	
c = 65	PORTAMENTO SWITCH	; v = 0 - 63: OFF, 64 - 127: ON	*2
c = 66	SOSTENUTO	; v = 0 - 63: OFF, 64 - 127: ON	
c = 71	HARMONIC CONTENT	; v = 0: -64 - 64: 0 - 127: +63	
c = 72	EG RELEASE TIME	; v = 0: -64 - 64: 0 - 127: +63	*2
c = 73	EG ATTACK TIME	; v = 0: -64 - 64: 0 - 127: +63	*2
c = 74	BRIGHTNESS	; v = 0: -64 - 64: 0 - 127: +63	
c = 75	EG DECAY TIME	; v = 0: -64 - 64: 0 - 127: +63	
c = 91	EFFECTS 1 DEPTH	; v = 0 - 127	
c = 94	EFFECTS 4 DEPTH	; v = 0 - 127	
c = 96	DATA ENTRY INC	; v = 127	*1
c = 97	DATA ENTRY DEC	; v = 127	*1
c = 1..95	ASSIGNABLE CONTROLLER	; v = 0 - 127	*4

All Control Change events can be recorded to the song/pattern.

*1 Used only when a value is set using RPN.
*2 Invalid with Drum Parts.
*3 Relation between BANK CHANGE and PROGRAM is as follows:

CATEGORY	MSB	LSB	PROGRAM No.
GM Voice	0	0	0..127 (1..128)
GM Drum Voice	127	0	0 (1)
Performance (Single Part) Preset 1	63	0	0..127 (1..128)
:	:	:	:
Preset 32	63	31	0..127 (1..128)
User 1	63	32	0..127 (1..128)
:	:	:	:
User 5	63	36	0..127 (1..128)
Library 1	63	40	0..127 (1..128)
:	:	:	:
Library 40	63	79	0..127 (1..128)
Performance (Multi Part) Preset 1	64	0	0..127 (1..128)
:	:	:	:
Preset 32	64	31	0..127 (1..128)
User 1	64	32	0..127 (1..128)
:	:	:	:
User 5	64	36	0..127 (1..128)
Library 1	64	40	0..127 (1..128)
:	:	:	:
Library 40	64	79	0..127 (1..128)

*4 The default CONTROL NUMBERS of ASSIGNABLE CONTROLLER are as follows:

BREATH CONTROLLER	2
FOOT CONTROLLER 1	11
FOOT CONTROLLER 2	Super Knob
ASSIGNABLE KNOB 1	17
ASSIGNABLE KNOB 2	18
ASSIGNABLE KNOB 3	19
ASSIGNABLE KNOB 4	20
ASSIGNABLE KNOB 5	21
ASSIGNABLE KNOB 6	22
ASSIGNABLE KNOB 7	23
ASSIGNABLE KNOB 8	24
RIBBON CONTROLLER	16
ASSIGNABLE FUNCTION 1	86
ASSIGNABLE FUNCTION 2	87
MOTION SEQ HOLD	88
MOTION SEQ TRIGGER	89
FOOT SWITCH	Arp SW

*5 When the sustain pedal is set to something other than "FC3 (Half On)," operating the sustain pedal transmits only values of 0 (off) or 127 (on).

PORTAMENTO TIME sets the time it takes for the pitch to reach the next note played when PORTAMENTO SWITCH is set to on.
PAN position relatively changes according to the preset value for each Part.

EFFECTS 1 DEPTH controls Reverb Send Level.
 EFFECTS 4 DEPTH controls Variation Send Level.
 HARMONIC CONTENT adjusts the Resonance preset for each Part.
 Setting a value adds to or subtracts from the center value, 64, since it is an offset parameter.
 The larger the value more resonant sound will be produced.
 The effective range may be narrower than the range you can designate depending on the selected Part.
 The parameters, EG ATTACK TIME, EG DECAY TIME, EG SUSTAIN LEVEL, EG RELEASE TIME adjust the envelopes preset for each Part.
 Setting these values add to or subtract from the center value, 64, since these are offset parameters.
 BRIGHTNESS adjusts the Cutoff Frequency preset for each Part.
 Setting a value adds to or subtracts from the center value, 64, since it is an offset parameter.
 The smaller the value the Cutoff Frequency will be lowered.
 The effective range may be narrower than the range you can designate depending on the selected voice.
 Bank Select will be actually executed when the Program Change message is received.
 Bank Select and Program Change numbers that are not supported by Yamaha will be ignored.

(3-1-4) PROGRAM CHANGE

STATUS	1100nnnn (CnH)	n = 0 - 15 CHANNEL NUMBER
PROGRAM NUMBER	0ppppppp	p = 0 - 127

(3-1-5) CHANNEL AFTER TOUCH

STATUS	1101nnnn (DnH)	n = 0 - 15 CHANNEL NUMBER
VALUE	0vvvvvvv	v = 0 - 127 AFTER TOUCH VALUE

(3-1-6) PITCH BEND CHANGE

STATUS	1110nnnn (EnH)	n = 0 - 15 CHANNEL NUMBER
LSB	0vvvvvvv	PITCH BEND CHANGE LSB
MSB	0vvvvvvv	PITCH BEND CHANGE MSB

Transmitted with a resolution of 7 bits.

(3-2) CHANNEL MODE MESSAGES

STATUS	1011nnnn (BnH)	n = 0 - 15 CHANNEL NUMBER
CONTROL NUMBER	0ccccccc	c = CONTROL NUMBER
CONTROL VALUE	0vvvvvvv	v = DATA VALUE

(3-2-1) ALL SOUND OFF (CONTROL NUMBER = 78H, DATA VALUE = 0)

All the sounds currently played including the Channel Messages such as Note-On and Hold-On in a certain channel are muted when receiving this message.

(3-2-2) RESET ALL CONTROLLERS (CONTROL NUMBER = 79H, DATA VALUE = 0)

Resets the values set for the following controllers.

PITCH BEND CHANGE	0 (center)
CHANNEL AFTER TOUCH	0 (minimum)
MODULATION	0 (minimum)
EXPRESSION	127 (maximum)
BREATH CONTROLLER	127 (maximum)
FOOT CONTROLLER 1	127 (maximum)
FOOT CONTROLLER 2	127 (maximum)
FOOT SWITCH	0 (off)
RIBBON CONTROLLER	0 (center)
ASSIGNABLE FUNCTION 1	0 (off)
ASSIGNABLE FUNCTION 2	0 (off)
MOTION SEQ HOLD	0 (off)
SUSTAIN SWITCH	0 (off)
SOSTENUTO SWITCH	0 (off)
MOTION SEQ LANE 1	0 (minimum when Polarity is set to Unipolar and center when Polarity is set to Bipolar)
MOTION SEQ LANE 2	0 (minimum when Polarity is set to Unipolar and center when Polarity is set to Bipolar)
MOTION SEQ LANE 3	0 (minimum when Polarity is set to Unipolar and center when Polarity is set to Bipolar)
MOTION SEQ LANE 4	0 (minimum when Polarity is set to Unipolar and center when Polarity is set to Bipolar)
RPN	Not assigned; No change

Doesn't reset the following data:

PROGRAM CHANGE, BANK SELECT MSB/LSB, VOLUME, PAN, HARMONIC CONTENT, SUSTAIN LEVEL, RELEASE TIME, ATTACK TIME, DECAY TIME, BRIGHTNESS, EFFECTS 1 DEPTH, EFFECTS 4 DEPTH, PORTAMENTO SWITCH, PITCH BEND SENSITIVITY, FINE TUNING, COARSE TUNING, ASSIGNABLE KNOB 1-8

(3-2-3) ALL NOTE OFF (CONTROL NUMBER = 7BH, DATA VALUE = 0)

All the notes currently set to on in certain channel(s) are muted when receiving this message. However, if Sustain or Sostenuto is on, notes will continue sounding until these are turned off.

(3-2-4) OMNI MODE OFF (CONTROL NUMBER = 7CH, DATA VALUE = 0)

Performs the same function as when receiving ALL NOTES OFF.

(3-2-5) OMNI MODE ON (CONTROL NUMBER = 7DH, DATA VALUE = 0)

Performs the same function as when receiving ALL NOTES OFF.

(3-2-6) MONO (CONTROL NUMBER = 7EH, DATA VALUE = 0..16)

Performs the same function as when receiving ALL SOUNDS OFF. If the 3rd byte (mono) is within 0 through 16, the channel will be Mode 4 (m = 1).

(3-2-7) POLY (CONTROL NUMBER = 7FH, DATA VALUE = 0)

Performs the same function as when receiving ALL SOUNDS OFF. The channel will be Mode 3.

(3-3) REGISTERED PARAMETER NUMBER

STATUS	1011nnnn (BnH)	n = 0 - 15 CHANNEL NUMBER
LSB	01100100 (64H)	
RPN LSB	0ppppppp	p = RPN LSB (Refer to the table as shown below.)
MSB	01100101 (65H)	
RPN MSB	0qqqqqqq	q = RPN MSB (Refer to the table as shown below.)
DATA ENTRY MSB	00000110 (06H)	
DATA VALUE	0mmmmmmm	m = Data Value
DATA ENTRY LSB	00100110 (26H)	
DATA VALUE	01111111	l = Data Value

First, designate the parameter using RPN MSB/LSB numbers. Then, set its value with data entry MSB/LSB.

RPN	D. ENTRY	
LSB MSB MSB LSB	PARAMETER NAME	DATA RANGE
00H 00H mmH ---	PITCH BEND SENSITIVITY	00H - 18H (0 - 24 semitones)
01H 00H mmH 11H	MASTER FINE TUNE	{mmH, 11H} = {00H, 00H} - {40H, 00H} - {7FH, 7FH} (-8192*100/8192) - 0 - (+8191*100/8192)
02H 00H mmH ---	MASTER COARSE TUNE	28H - 40H - 58H (-24 - 0 - +24 semitones)
7FH 7FH --- ---	RPN RESET	

RPN numbers will be left not designated.
 The internal values are not affected.

(3-4) SYSTEM REAL TIME MESSAGES**(3-4-1) ACTIVE SENSING**

STATUS	11111110 (FEH)
--------	----------------

Transmitted at every 200 msec.
 Once this code is received, the instrument starts sensing.
 When no status nor data is received for over approximately 350 ms, MIDI receiving buffer will be cleared, and the sounds currently played is forcibly turned off.

(3-5) SYSTEM EXCLUSIVE MESSAGE**(3-5-1) UNIVERSAL NON REALTIME MESSAGE****(3-5-1-1) GENERAL MIDI MODE ON**

FOH 7EH 7FH 09H 01H F7H

The internal tone generator block will receive this message except when the Compare function is activated.

(3-5-1-2) IDENTITY REQUEST (Receive only)

FOH 7EH 0nH 06H 01H F7H

("n" = Device No. However, this instrument receives under "omni.")

(3-5-1-3) IDENTITY REPLY (Transmit only)

FOH 7EH 7FH 06H 02H 43H 00H 41H ddH mmH 00H 00H 7FH F7H

dd:	Device family number/code
MONTAGE6:	4EH 06H
MONTAGE7:	4FH 06H
MONTAGE8:	50H 06H
mm:	version
mm =	(version no. - 1.0) * 10
e.g.)	version 1.0 mm = (1.0 - 1.0) * 10 = 0
	version 1.5 mm = (1.5 - 1.0) * 10 = 5

(3-5-2) UNIVERSAL REALTIME MESSAGE**(3-5-2-1) MIDI MASTER VOLUME**

FOH 7FH 7FH 04H 01H 11H mmH F7H

Sets the MASTER VOLUME value.
 The value "mm" is used to set the master volume (the value "11" should be ignored).

(3-5-3) PARAMETER CHANGE**(3-5-3-1) NATIVE PARAMETER CHANGE, MODE CHANGE**

11110000	F0	Exclusive Status
01000011	43	YAMAHA ID
0001nnnn	1n	Device Number
01111111	7F	Group ID High
00011100	1C	Group ID Low
00000010	02	Model ID
0aaaaaaaa	aaaaaaaa	Address High
0aaaaaaaa	aaaaaaaa	Address Mid
0aaaaaaaa	aaaaaaaa	Address Low
0ddddddd	ddddddd	Data
11110111	F7	End of Exclusive

For parameters with data size of 2 or more, the appropriate number of data bytes will be transmitted. See the following MIDI Data Table for Address.

(3-5-4) BULK DUMP

11110000	F0	Exclusive Status
01000011	43	YAMAHA ID
0001nnnn	0n	Device Number
01111111	7F	Group ID High
00011100	1C	Group ID Low
0bbbbbbb	bbbbbbb	Byte Count
0bbbbbbb	bbbbbbb	Byte Count
00000010	02	Model ID
0aaaaaaaa	aaaaaaaa	Address High
0aaaaaaaa	aaaaaaaa	Address Mid
0aaaaaaaa	aaaaaaaa	Address Low
0	0	Data
0ccccccc	ccccccc	Check-sum
11110111	F7	End of Exclusive

See the following BULK DUMP Table for Address and Byte Count.
 The Check sum is the value that results in a value of 0 for the lower 7 bits when the Byte Count, Start Address, Data and Check sum itself are added.

(3-5-5) DUMP REQUEST

11110000	F0	Exclusive Status
01000011	43	YAMAHA ID
0010nnnn	2n	Device Number
01111111	7F	Group ID High
00011100	1C	Group ID Low
00000010	02	Model ID
0aaaaaaaa	aaaaaaaa	Address High
0aaaaaaaa	aaaaaaaa	Address Mid
0aaaaaaaa	aaaaaaaa	Address Low
11110111	F7	End of Exclusive

See the following DUMP REQUEST Table for Address.

(3-5-6) PARAMETER REQUEST

11110000	F0	Exclusive Status
01000011	43	YAMAHA ID
0010nnnn	3n	Device Number
01111111	7F	Group ID High
00011100	1C	Group ID Low
00000010	02	Model ID
0aaaaaaaa	aaaaaaaa	Address High
0aaaaaaaa	aaaaaaaa	Address Mid
0aaaaaaaa	aaaaaaaa	Address Low
11110111	F7	End of Exclusive

See the following MIDI Data Table for Address.

(4) SYSTEM OVERVIEW (Keyboard, Sequencer and Tone Generator)

MIDI IN/OUT = MIDI

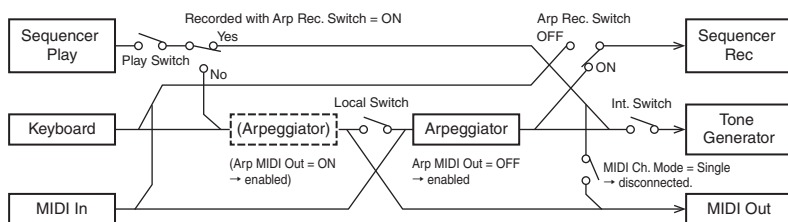

MIDI IN/OUT = USB

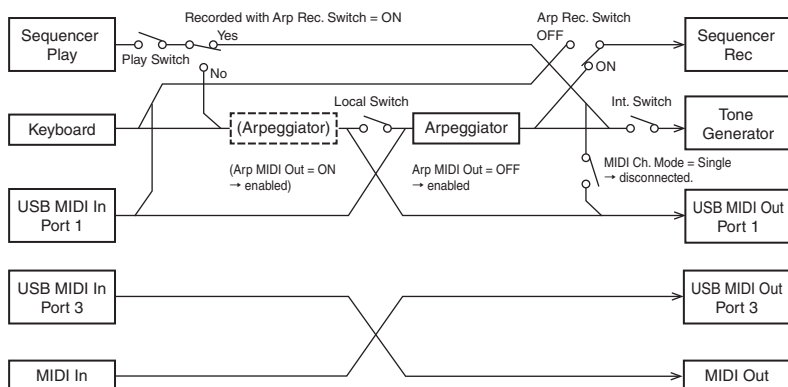

Although three types of note on/note off data, received via MIDI, played by the internal sequencer and played on the keyboard will be distinguished, the other controllers (channel messages) equally affect the entire notes.

ALL SOUND OFF clears all the sounds in the specific channel(s) played by both the keyboard and the data via MIDI.
 ALL NOTES OFF received via MIDI clears the sounds in the specific channel(s) played via MIDI.

MIDI Data Table

Bank Select

Available Bank Select/Program Change

MSB (HEX)	LSB (HEX)	Program No.	Type	Memory	Description
0	00	0 - 127	Normal Voice	GM Voice	
127	7F	0	Drum Voice	GM Drum	
63	3F	0 - 127	Performance (Single Part)	Preset 1 - 32	Can be used when only specified Part is changed.
		0		Preset 1	
		1		Preset 2	
		2		Preset 3	
		3		Preset 4	
		4		Preset 5	
		5		Preset 6	
		6		Preset 7	
		7		Preset 8	
		8		Preset 9	
		9		Preset 10	
		10		Preset 11	
		11		Preset 12	
		12		Preset 13	
		13		Preset 14	
		14		Preset 15	
		15		Preset 16	
		16		Preset 17	
		17		Preset 18	
		18		Preset 19	
		19		Preset 20	
		20		Preset 21	
		21		Preset 22	
		22		Preset 23	
		23		Preset 24	
		24		Preset 25	
		25		Preset 26	
		26		Preset 27	
		27		Preset 28	
		28		Preset 29	
		29		Preset 30	
		30		Preset 31	
		31		Preset 32	
		32		User 1	
		33		User 2	
		34		User 3	
		35		User 4	
		36		User 5	
		37		reserved	
		38		reserved	
		39		reserved	
		40		Library 1	
		41		Library 2	
		42		Library 3	
		43		Library 4	
		44		Library 5	
		45		Library 6	
		46		Library 7	
		47		Library 8	
		48		Library 9	
		49		Library 10	
		50		Library 11	
		51		Library 12	
		52		Library 13	
		53		Library 14	
		54		Library 15	
		55		Library 16	
		56		Library 17	
		57		Library 18	
		58		Library 19	
		59		Library 20	
		60		Library 21	
		61		Library 22	
		62		Library 23	
		63		Library 24	
		64		Library 25	
		65		Library 26	
		66		Library 27	
		67		Library 28	
		68		Library 29	
		69		Library 30	
		70		Library 31	
		71		Library 32	
		72		Library 33	
		73		Library 34	
		74		Library 35	

Available Bank Select/Program Change

MSB (HEX)	LSB (HEX)	Program No.	Type	Memory	Description
63	3F	75 - 79	Performance (Single Part)	Library 36 - 40	Can be used when only specified Part is changed.
		75		Library 36	
		76		Library 37	
		77		Library 38	
		78		Library 39	
		79		Library 40	
64	40	0 - 71	Performance (Multi Part)	Preset 1 - 32	Can be used when all Parts are changed.
		0		Preset 1	
		1		Preset 2	
		2		Preset 3	
		3		Preset 4	
		4		Preset 5	
		5		Preset 6	
		6		Preset 7	
		7		Preset 8	
		8		Preset 9	
		9		Preset 10	
		10		Preset 11	
		11		Preset 12	
		12		Preset 13	
		13		Preset 14	
		14		Preset 15	
		15		Preset 16	
		16		Preset 17	
		17		Preset 18	
		18		Preset 19	
		19		Preset 20	
		20		Preset 21	
		21		Preset 22	
		22		Preset 23	
		23		Preset 24	
		24		Preset 25	
		25		Preset 26	
		26		Preset 27	
		27		Preset 28	
		28		Preset 29	
		29		Preset 30	
		30		Preset 31	
		31		Preset 32	
		32		User 1	
		33		User 2	
		34		User 3	
		35		User 4	
		36		User 5	
		37		reserved	
		38		reserved	
		39		reserved	
		40		Library 1	
		41		Library 2	
		42		Library 3	
		43		Library 4	
		44		Library 5	
		45		Library 6	
		46		Library 7	
		47		Library 8	
		48		Library 9	
		49		Library 10	
		50		Library 11	
		51		Library 12	
		52		Library 13	
		53		Library 14	
		54		Library 15	
		55		Library 16	
		56		Library 17	
		57		Library 18	
		58		Library 19	
		59		Library 20	
		60		Library 21	
		61		Library 22	
		62		Library 23	
		63		Library 24	
		64		Library 25	
		65		Library 26	
		66		Library 27	
		67		Library 28	
		68		Library 29	
		69		Library 30	
		70		Library 31	
		71		Library 32	

Available Bank Select/Program Change

MSB (HEX)	LSB (HEX)	Program No.	Type	Memory	Description		
64	40	72	48	0 - 127	Performance (Multi Part)	Library 33 Library 34 Library 35 Library 36 Library 37 Library 38 Library 39 Library 40	Can be used when all Parts are changed.
		73	49	0 - 127			
		74	4A	0 - 127			
		75	4B	0 - 127			
		76	4C	0 - 127			
		77	4D	0 - 127			
		78	4E	0 - 127			
		79	4F	0 - 127			

Available Live Set Select/Program Change

MSB (HEX)	LSB (HEX)	Program No.	Live Set Slot		
62	3E	00	00	0 - 15	Page 1, Slot 1 - 16
		1	01	0 - 15	Page 2, Slot 1 - 16
		2	02	0 - 15	Page 3, Slot 1 - 16
		3	03	0 - 15	Page 4, Slot 1 - 16
		4	04	0 - 15	Page 5, Slot 1 - 16
		5	05	0 - 15	Page 6, Slot 1 - 16
		6	06	0 - 15	Page 7, Slot 1 - 16
		7	07	0 - 15	Page 8, Slot 1 - 16
		8	08	0 - 15	Page 9, Slot 1 - 16
		9	09	0 - 15	Page 10, Slot 1 - 16
		10	0A	0 - 15	Page 11, Slot 1 - 16
		11	0B	0 - 15	Page 12, Slot 1 - 16
		12	0C	0 - 15	Page 13, Slot 1 - 16
		13	0D	0 - 15	Page 14, Slot 1 - 16
		14	0E	0 - 15	Page 15, Slot 1 - 16
		15	0F	0 - 15	Page 16, Slot 1 - 16

Parameter Base Address

Parameter Block	Top Address			Description
	H	M	L	
SYSTEM	00	00	00	System
	00	05	00	Sequencer Setup
	00	3n	00	Micro Tuning User Table [nn: No. (0...7)]
	00	5n	00	Micro Tuning User Table Name [nn: No. (0...7)]
CURVE	01	nn	00	Curve User Table (including names)
LIVE SET	02	00	00	Live Set Bank Name
	03	0p	00	Live Set Page Name [p: Page No. (0...15)]
	04	ps	00	Live Set Page 1 - 8 Slot Table [p: Page No. (0...7), s: Slot No. (0...15)]
	05	ps	00	Live Set Page 9 - 16 Slot Table [p: Page No. (0...7), s: Slot No. (0...15)]
	BULK CONTROL	0E	00	00
	0F	00	00	Footer
PERFORMANCE COMMON	30	40	00	Performance Common
	30	41	00	Reverb
	30	42	00	Variation
	30	43	00	Insertion A for A/D
	30	44	00	Insertion B for A/D
	30	45	00	Master EQ
	30	46	00	Master Effect
	30	47	00	Arpeggio Common
	30	48	00	Motion Seq Common Settings
	30	49	00	Motion Seq AD Part Lane Settings
	30	1m	00	Motion Seq AD Part Lane Sequence [l: Lane No. (0...3), m: Motion Seq No. (0...7)]
	30	4A	00	Super Knob Lane Settings
	30	6m	00	Super Knob Sequence [m: Motion Sequence No. (0...7)]
	30	4B	00	Super Knob Settings
	30	4C	00	Scene Common
	30	4D	00	Audition
	30	4E	00	Audio In Part1 (A/D)
	30	4F	00	Audio In Part2 (USB)
	30	50	00	Assignable Knob Name
	30	51	00	Common/AD Controller 1 - 13
30	52	00	Common/AD Controller 14 - 16	
PERFORMANCE PART	31	0p	00	Performance Part [p: Part No. (0...15)]
	31	1p	00	Motion Seq Part/Lane Settings [p: Part No. (0...15)]
	31	2p	00	Insertion A [p: Part No. (0...15)]
	31	3p	00	Insertion B [p: Part No. (0...15)]
	31	4p	00	LFO [p: Part No. (0...15)]
	31	5p	00	Zone Setting [p: Part No. (0...15)]
	31	6p	00	Arpeggio Part [p: Part No. (0...15)]
	32	sp	00	Motion Seq Lane 1 Sequence [s: Sequence No. (0...7), p: Part No. (0...15)]
	33	sp	00	Motion Seq Lane 2 Sequence [s: Sequence No. (0...7), p: Part No. (0...15)]
	34	sp	00	Motion Seq Lane 3 Sequence [s: Sequence No. (0...7), p: Part No. (0...15)]
	35	sp	00	Motion Seq Lane 4 Sequence [s: Sequence No. (0...7), p: Part No. (0...15)]
	36	cp	00	Scene Part [c: Scene No. (0...7), p: Part No. (0...15)]
	37	0p	00	Assignable Knob Name [p: Part No. (0...15)]
	38	0p	00	Controller 1 - 13 [p: Part No. (0...15)]
	38	1p	00	Controller 14 - 16 [p: Part No. (0...15)]
	NORMAL PART ELEMENT GROUP 1	41	ep	00
NORMAL PART ELEMENT GROUP 2	42	ep	00	Filter + EQ + LFO [p: Part No. (0...15), e: Element No. (0...7)]
DRUM PART KEY GROUP 1	5p	kk	00	Key [kk: Key No. (0...72), p: Part No. (0...15)]
FM PART COMMON	48	0p	00	Common [p: Part No. (0...15)]
FM PART OPERATOR	49	op	00	Operator [o: Operator No. (0...7), p: Part No. (0...15)]

Bulk Dump Block

"Top Address" indicates the top address of each block designated by bulk dump operation.
 "Byte Count" indicates the data size contained in each block designated by bulk dump operation.

The Block from the Bulk Header to the Bulk Footer of the Performance can be received regardless of their order. They can be received even if all of them are not transmitted. They cannot be received if the irrelevant Block is included.

To execute 1 Performance bulk dump request, designate its corresponding Bulk Header address.

For the information about "mm" and "nn" shown in the following list, refer to MIDI PARAMETER CHANGE TABLE (BULK CONTROL) below.

Parameter Block	Description	Byte Count		Top Address		
		Dec	Hex	H	M	L
SYSTEM	System	60	003C	00	00	00
	Sequencer	22	0016	00	05	00
MICRO TUNING	Table 1	24	0018	00	30	00
	:	8 Blocks		:	:	:
MICRO TUNING NAME	Table 8	24	0018	00	37	00
	:	8 Blocks		:	:	:
CURVE	Bulk Header	0	0000	0E	40	00
	Curve [nn: User Curve No. (0...31)]	37	0025	01	00	00
	Bulk Footer	0	0000	0F	40	00

LIVE SET	Bulk Header	0	0000	0E	41	00
	Live Set Bank Name	20	0014	02	00	00
	Live Set Page Name [p: Page No. (0...15)]	20	0014	03	0p	00
	Live Set Page 1-8 Slot Table [p: Page No. (0...7), s: Slot No. (0...15)]	26	001A	04	ps	00
	Live Set Page 9-16 Slot Table [p: Page No. (0...7), s: Slot No. (0...15)]	26	001A	05	ps	00
	Bulk Footer	0	0000	0F	41	00

PERFORMANCE	Bulk Header	0	0000	0E	mm	nn
PERFORMANCE COMMON	Performance Common	94	005E	30	40	00
	Reverb	71	0047	30	41	00
	Variation	72	0048	30	42	00
	Insertion A for A/D	68	0044	30	43	00
	Insertion B for A/D	68	0044	30	44	00
	Master EQ	21	0015	30	45	00
	Master Effect	72	0048	30	46	00
	Arpeggio Common	13	000D	30	47	00
	Motion Seq Common Settings	6	0006	30	48	00
	Motion Seq AD Part Lane Settings	64	0040	30	49	00
	Motion Seq AD Part Lane Sequence [l: Lane No. (0...3), m: Motion Seq No. (0...7)]	50	0032	30	lm	00
	Super Knob Lane Settings	15	0000F	30	4A	00
	Super Knob Sequence [m: Motion Sequence No. (0...7)]	50	0032	30	6m	00
	Super Knob Settings	28	001C	30	4B	00
	Scene Common	128	0080	30	4C	00
	Audition	4	0004	30	4D	00
	Audio In Part1 (A/D)	28	001C	30	4E	00
	Audio In Part2 (USB)	23	0017	30	4F	00
	Assignable Knob Name	128	0080	30	50	00
	Common/AD Controller 1 - 13	117	0075	30	51	00
Common/AD Controller 14 - 16	27	001B	30	52	00	
PERFORMANCE PART	Performance Part [p: Part No. (0...15)]	121	0079	31	0p	00
	Motion Seq Part/Lane Settings [p: Part No. (0...15)]	64	0040	34	1p	00
	Insertion A [p: Part No. (0...15)]	68	0044	31	2p	00
	Insertion B [p: Part No. (0...15)]	68	0044	31	3p	00
	LFO [p: Part No. (0...15)]	39	0027	31	4p	00
	Zone Setting [p: Part No. (0...15)]	17	0011	31	5p	00
	Assignable Knob Name [p: Part No. (0...15)]	128	0080	37	0p	00
	Controller 1 - 13 [p: Part No. (0...15)]	117	0075	38	0p	00
	Controller 14 - 16 [p: Part No. (0...15)]	27	001B	38	1p	00

Parameter Block	Description	Byte Count		Top Address		
		Dec	Hex	H	M	L
PERFORMANCE PART	Arpeggio Part [p: Part No. (0...15)]	92	005C	31	6p	00
	Motion Seq Lane 1 Sequence [s: Sequence No. (0...7), p: Part No. (0...15)]	50	0032	32	sp	00
	Motion Seq Lane 2 Sequence [s: Sequence No. (0...7), p: Part No. (0...15)]	50	0032	33	sp	00
	Motion Seq Lane 3 Sequence [s: Sequence No. (0...7), p: Part No. (0...15)]	50	0032	34	sp	00
	Motion Seq Lane 4 Sequence [s: Sequence No. (0...7), p: Part No. (0...15)]	50	0032	35	sp	00
	Scene Part [c: Scene No. (0...7), p: Part No. (0...15)]	26	001A	36	cp	00
	:	Max 16 Parts				
NORMAL PART ELEMENT	Oscillator + Amplitude + Pitch [p: Part No. (0...15), e: Element No. (0...7)]	103	0067	41	ep	00
	Filter + EQ + LFO [p: Part No. (0...15), e: Element No. (0...7)]	70	0046	42	ep	00
	:	8 Blocks, Max 16 Parts				
DRUM PART KEY	Key [kk: Key No. (0...72), p: Part No. (0...15)]	47	002F	5p	kk	00
	:	73 Blocks, Max 16 Parts				
FM PART	Common [p: Part No. (0...15)]	86	0056	48	0p	00
FM PART OPERATOR	Operator [o: Operator No. (0...7), p: Part No. (0...15)]	47	002F	49	op	00
	:	8 Blocks, Max 16 Parts				
	Bulk Footer	0	00	0F	mm	nn

PERFORMANCE PART	Bulk Header	0	00	0E	42	nn	
PERFORMANCE PART	Performance Part [p: Part No. (0...15)]	121	0079	31	0p	00	
	Motion Seq Part/Lane Settings [p: Part No. (0...15)]	64	0040	31	1p	00	
	Insertion A [p: Part No. (0...15)]	68	0044	31	2p	00	
	Insertion B [p: Part No. (0...15)]	68	0044	31	3p	00	
	LFO [p: Part No. (0...15)]	39	0027	31	4p	00	
	Zone Setting [p: Part No. (0...15)]	17	0011	31	5p	00	
	Assignable Knob Name [p: Part No. (0...15)]	128	0080	37	0p	00	
	Controller 1 - 13 [p: Part No. (0...15)]	117	0075	38	0p	00	
	Controller 14 - 16 [p: Part No. (0...15)]	27	001B	38	1p	00	
	Arpeggio Part [p: Part No. (0...15)]	92	005C	31	6p	00	
	Motion Seq Lane 1 Sequence [s: Sequence No. (0...7), p: Part No. (0...15)]	50	0032	32	sp	00	
	Motion Seq Lane 2 Sequence [s: Sequence No. (0...7), p: Part No. (0...15)]	50	0032	33	sp	00	
	Motion Seq Lane 3 Sequence [s: Sequence No. (0...7), p: Part No. (0...15)]	50	0032	34	sp	00	
	Motion Seq Lane 4 Sequence [s: Sequence No. (0...7), p: Part No. (0...15)]	50	0032	35	sp	00	
	Scene Part [c: Scene No. (0...7), p: Part No. (0...15)]	26	001A	36	cp	00	
	NORMAL PART ELEMENT	Oscillator + Amplitude + Pitch [p: Part No. (0...15), e: Element No. (0...7)]	103	0067	41	ep	00
		Filter + EQ + LFO [p: Part No. (0...15), e: Element No. (0...7)]	70	0046	42	ep	00
	:	8 Blocks					
	DRUM PART KEY	Key [kk: Key No. (0...72), p: Part No. (0...15)]	47	002F	5p	kk	00
		:	73 Blocks				
FM PART	Common [p: Part No. (0...15)]	86	0056	48	0p	00	
FM PART OPERATOR	Operator [o: Operator No. (0...7), p: Part No. (0...15)]	47	002F	49	op	00	
	:	8 Blocks					
	Bulk Footer	0	00	0F	42	nn	

Address	Size	Range (HEX)	Parameter Name	Description	Default (HEX)	Notes
50	00	1	-	Bulk Footer	Curve Edit Buffer	-
51	00	1	-		Live Set Edit Buffer	-
52	nn	1	-		Performance Edit Buffer Part nn (nn = 0 – 15)	-
53	00	1	-		Performance Edit Buffer Common	-

MIDI PARAMETER CHANGE TABLE (SYSTEM)

Address	Size	Data Range (HEX)	Parameter Name	Description	Default (HEX)	Notes	
00 00 00	1	00 – 7F	Tone Generator Volume	0 – 127	7F	MIDI Master Volume	
	01	1	28 – 58	Tone Generator Note Shift	-24 – +24 semi	40	
	02	4	00 – 00 00 – 07 00 – 0F 00 – 0F	Tone Generator Tune	-102.4 – +102.3 1st bit3-0 → bit15-12 2nd bit3-0 → bit11-8 3rd bit3-0 → bit7-4 4th bit3-0 → bit3-0	00 04 00 00 (0400)	MIDI Master Tuning
	06	1	00 – 01	Controller Reset	Hold, Reset	01	
	07	1	35 – 4B	Keyboard Transpose	-11 – +11 semi	40	
	08	1	3D – 43	Keyboard Octave Shift	-3 – +3	40	
	09	1	00 – 01	Local Control	Off, On	01	
	0A	1		reserved			
	0B	1		reserved			
	0C	1	00 – 01	Touch Panel Sound Switch	Off, On	01	
	0D	1	00 – 03	Analog Output L&R Output Gain	00: -6dB, 01: +0dB, 02: +6dB, 03: +12dB	01	
	0E	1	00 – 03	Assignable Output L&R Output Gain	00: -6dB, 01: +0dB, 02: +6dB, 03: +12dB	01	
	0F	1	00 – 03	USB Main L&R Output Gain	00: -6dB, 01: +0dB, 02: +6dB, 03: +12dB	01	
	10	1	00 – 03	USB Individual Output Gain	00: -6dB, 01: +0dB, 02: +6dB, 03: +12dB	01	
	11	1	00 – 04	Keyboard Velocity Curve	Normal, Soft, Hard, Wide, Fixed	00	
	12	1	01 – 7F	Keyboard Fixed Velocity	1 – 127	40	
	13	1		reserved		00	
	14	1	00 – 01	Receive/Transmit Bank Select	Off, On	01	
	15	1	00 – 01	Receive/Transmit Program Change	Off, On	01	
	16	1	00 – 65	FS Assign Control Number	Off, 1 – 95, Arp SW, MS SW, Play/Stop, Live Set +, Live Set -, Oct reset	60	
	17	1	00 – 5F	Super Knob Control Number	Off, 1 – 95	5F	
	18	1	00 – 01	MIDI I/OUT	MIDI, USB	00	
	19	1	00 – 5F	Scene Select Control Number	Off, 1 – 95	5E	
	1A	1		reserved			
	1B	1		reserved			
	1C	1		reserved			
	1D	1	00 – 01	Audition Lock	Off, On	00	
	1E	1	00 – 01	Power on Mode	Perform, Live Set	01	
	1F	1	00 – 12	Bulk Interval	0 – 900ms	01	
	20	1	00 – 10	Power on Live Set Bank	Preset, User 1, ... User 8, Library 1, ... Library 8	01	
	21	1	00 – 0F	Power on Live Set Page	Page 1, ... Page 16	00	
	22	1	00 – 0F	Power on Live Set Slot	Slot 1, ... Slot 16	00	
	23	1		reserved			
	24	1	00 – 01	A/D Input Gain	Mic, Line	01	
	25	1	00 – 7F	USB Input Volume	0 – 127	7F	
	26	1	00 – 02	LED Half Glow Brightness	Off, 1/4, 1/2	01	
	27	1	00 – 01	Direct Monitor Switch	Off, On	00	
	28	1	00 – 01	Arpeggiator MIDI Out Switch	Off, On	00	
	29	1		reserved			
	2A	1		reserved			
	2B	1		reserved			
	2C	1		reserved			
	2D	1		reserved			
	2E	1		reserved			
	2F	1		reserved			
	30	1	00 – 01	MIDI I/O Mode	Multi, Single	00	
	31	1	00 – 0F	MIDI I/O Channel	ch1, ..., ch16	00	
	32	1		reserved			
	33	1		reserved			
	34	1		reserved			
	35	1		reserved			
	36	1		reserved			
	37	1		reserved			
	38	1		reserved			
	39	1		reserved			
	3A	1		reserved			
	3B	1	00 – 02	Sustain Pedal Select	FC3A (Half On), FC3A (Half Off), FC4A/FC5	00	

TOTAL SIZE = 60 3C (HEX)

MIDI PARAMETER CHANGE TABLE (CURVE)

Address	Size	Data Range (HEX)	Parameter Name	Description	Default (HEX)	Notes
00 05 00	1	00 - 03	Click Mode	Off, Rec, Rec/Play, Always	01	For SEQ
	01	00 - 5F	Click Output Select	0: MainL&R, 8: AsgnL&R, 9 - 23: USB1&2...USB29&30, 64 - 95: AsgnL, AsgnR, USB1...USB30	00	:
	02	00 - 7F	Click Volume	0 - 127	64	:
	03	00 - 09	Click Type	1 - 10	00	:
	04	00 - 04	Click Beat	16th, 8th, 4th, 2nd, Whole	02	:
	05	00 - 08	Recording Count	Off, 1 - 8meas	01	:
	06	1	reserved			
	07	00 - 01	Transmit Sequencer Control	Off, On	00	:
	08	00 - 01	Receive Sequencer Control	Off, On	00	:
	09	00 - 02	Song Event Chase	Off, PC, PC+PB+Ctrl	00	:
	0A	1	reserved			
	0B	00 - 02	MIDI Sync	Internal, MIDI, A/D In	01	:
	0C	00 - 01	MIDI Clock Out	Off, On	01	:
	0D	1	reserved			
	0E	4	reserved			
	12	2	reserved			
	14	2	reserved			

TOTAL SIZE = 22 16 (HEX)

Address	Size	Data Range (HEX)	Parameter Name	Description	Default (HEX)	Notes
00 3n 00	2	00 - 01 00 - 7F	Micro Tuning C# MSB Micro Tuning C# LSB	-99 - 0 - +99 [cent] 1st bit6-0 → bit13-7 2nd bit6-0 → bit6-0	01 00	
	02	00 - 01 00 - 7F	Micro Tuning C# MSB Micro Tuning C# LSB	:	01 00	
	04	00 - 01 00 - 7F	Micro Tuning D# MSB Micro Tuning D# LSB	:	01 00	
	06	00 - 01 00 - 7F	Micro Tuning D# MSB Micro Tuning D# LSB	:	01 00	
	08	00 - 01 00 - 7F	Micro Tuning E# MSB Micro Tuning E# LSB	:	01 00	
	0A	00 - 01 00 - 7F	Micro Tuning F# MSB Micro Tuning F# LSB	:	01 00	
	0C	00 - 01 00 - 7F	Micro Tuning F# MSB Micro Tuning F# LSB	:	01 00	
	0E	00 - 01 00 - 7F	Micro Tuning G# MSB Micro Tuning G# LSB	:	01 00	
	10	00 - 01 00 - 7F	Micro Tuning G# MSB Micro Tuning G# LSB	:	01 00	
	12	00 - 01 00 - 7F	Micro Tuning A# MSB Micro Tuning A# LSB	:	01 00	
	14	00 - 01 00 - 7F	Micro Tuning A# MSB Micro Tuning A# LSB	:	01 00	
	16	00 - 01 00 - 7F	Micro Tuning B# MSB Micro Tuning B# LSB	:	01 00	

TOTAL SIZE = 24 18 (HEX)

n = User Table number
00 - 07 Table 1 - 8

Address	Size	Data Range (HEX)	Parameter Name	Description	Default (HEX)	Notes
00 5n 00	1	00, 20 - 7E	Micro Tuning Table Name 1	0, 32 - 126 (ASCII)	Init Tuning 1 - 8 (same as the table number)	
	01	00, 20 - 7E	Micro Tuning Table Name 2	0, 32 - 126 (ASCII)		
	02	00, 20 - 7E	Micro Tuning Table Name 3	0, 32 - 126 (ASCII)		
	03	00, 20 - 7E	Micro Tuning Table Name 4	0, 32 - 126 (ASCII)		
	04	00, 20 - 7E	Micro Tuning Table Name 5	0, 32 - 126 (ASCII)		
	05	00, 20 - 7E	Micro Tuning Table Name 6	0, 32 - 126 (ASCII)		
	06	00, 20 - 7E	Micro Tuning Table Name 7	0, 32 - 126 (ASCII)		
	07	00, 20 - 7E	Micro Tuning Table Name 8	0, 32 - 126 (ASCII)		
	08	00, 20 - 7E	Micro Tuning Table Name 9	0, 32 - 126 (ASCII)		
	09	00, 20 - 7E	Micro Tuning Table Name 10	0, 32 - 126 (ASCII)		
	0A	00, 20 - 7E	Micro Tuning Table Name 11	0, 32 - 126 (ASCII)		
	0B	00, 20 - 7E	Micro Tuning Table Name 12	0, 32 - 126 (ASCII)		
	0C	00, 20 - 7E	Micro Tuning Table Name 13	0, 32 - 126 (ASCII)		
	0D	00, 20 - 7E	Micro Tuning Table Name 14	0, 32 - 126 (ASCII)		
	0E	00, 20 - 7E	Micro Tuning Table Name 15	0, 32 - 126 (ASCII)		
	0F	00, 20 - 7E	Micro Tuning Table Name 16	0, 32 - 126 (ASCII)		
	10	00, 20 - 7E	Micro Tuning Table Name 17	0, 32 - 126 (ASCII)		
	11	00, 20 - 7E	Micro Tuning Table Name 18	0, 32 - 126 (ASCII)		
	12	00, 20 - 7E	Micro Tuning Table Name 19	0, 32 - 126 (ASCII)		
	13	00, 20 - 7E	Micro Tuning Table Name 20	0, 32 - 126 (ASCII)		

TOTAL SIZE = 20 14 (HEX)

n = User Table number
00 - 07

Address	Size	Data Range (HEX)	Parameter Name	Description	Default (HEX)	Notes
01 nn 00	1	00, 20 - 7E	Curve Name 1	0, 32 - 126 (ASCII)	Initialized Curves	
	01	00, 20 - 7E	Curve Name 2	0, 32 - 126 (ASCII)		
	02	00, 20 - 7E	Curve Name 3	0, 32 - 126 (ASCII)		
	03	00, 20 - 7E	Curve Name 4	0, 32 - 126 (ASCII)		
	04	00, 20 - 7E	Curve Name 5	0, 32 - 126 (ASCII)		
	05	00, 20 - 7E	Curve Name 6	0, 32 - 126 (ASCII)		
	06	00, 20 - 7E	Curve Name 7	0, 32 - 126 (ASCII)		
	07	00, 20 - 7E	Curve Name 8	0, 32 - 126 (ASCII)		
	08	00, 20 - 7E	Curve Name 9	0, 32 - 126 (ASCII)		
	09	00, 20 - 7E	Curve Name 10	0, 32 - 126 (ASCII)		
	0A	00, 20 - 7E	Curve Name 11	0, 32 - 126 (ASCII)		
	0B	00, 20 - 7E	Curve Name 12	0, 32 - 126 (ASCII)		
	0C	00, 20 - 7E	Curve Name 13	0, 32 - 126 (ASCII)		
	0D	00, 20 - 7E	Curve Name 14	0, 32 - 126 (ASCII)		
	0E	00, 20 - 7E	Curve Name 15	0, 32 - 126 (ASCII)		
	0F	00, 20 - 7E	Curve Name 16	0, 32 - 126 (ASCII)		
	10	00, 20 - 7E	Curve Name 17	0, 32 - 126 (ASCII)		
	11	00, 20 - 7E	Curve Name 18	0, 32 - 126 (ASCII)		
	12	00, 20 - 7E	Curve Name 19	0, 32 - 126 (ASCII)		
	13	00, 20 - 7E	Curve Name 20	0, 32 - 126 (ASCII)		
	14	1	00	Curve Input 1	0	00 Fixed to "0"
	15	1	01 - 79	Curve Input 2	1 - 121	12
	16	1	02 - 7A	Curve Input 3	2 - 122	24
	17	1	03 - 7B	Curve Input 4	3 - 123	36
	18	1	04 - 7C	Curve Input 5	4 - 124	48
	19	1	05 - 7D	Curve Input 6	5 - 125	5A
	1A	1	06 - 7E	Curve Input 7	6 - 126	6C
	1B	1	07 - 7F	Curve Input 8	7 - 127	7F Fixed to 7F in the Linear Mode
	1C	1	00 - 7F	Curve Output 1	0 - 127	00
	1D	1	00 - 7F	Curve Output 2	0 - 127	12
	1E	1	00 - 7F	Curve Output 3	0 - 127	24
	1F	1	00 - 7F	Curve Output 4	0 - 127	36
	20	1	00 - 7F	Curve Output 5	0 - 127	48
	21	1	00 - 7F	Curve Output 6	0 - 127	5A
	22	1	00 - 7F	Curve Output 7	0 - 127	6C
	23	1	00 - 7F	Curve Output 8	0 - 127	7F
	24	1	00 - 01	Curve Type	00 = Linear, 01 = Step	00

TOTAL SIZE = 37 25 (HEX)

n = User Curve number
00 - 1F

MIDI PARAMETER CHANGE TABLE (LIVE SET)

Address	Size	Data Range (HEX)	Parameter Name	Description	Default (HEX)	Notes	
02	00	00	1	00, 20 - 7E	Live Set Bank Name 1	0, 32 - 126 (ASCII)	Initialized Bank
		01	1	00, 20 - 7E	Live Set Bank Name 2	0, 32 - 126 (ASCII)	
		02	1	00, 20 - 7E	Live Set Bank Name 3	0, 32 - 126 (ASCII)	
		03	1	00, 20 - 7E	Live Set Bank Name 4	0, 32 - 126 (ASCII)	
		04	1	00, 20 - 7E	Live Set Bank Name 5	0, 32 - 126 (ASCII)	
		05	1	00, 20 - 7E	Live Set Bank Name 6	0, 32 - 126 (ASCII)	
		06	1	00, 20 - 7E	Live Set Bank Name 7	0, 32 - 126 (ASCII)	
		07	1	00, 20 - 7E	Live Set Bank Name 8	0, 32 - 126 (ASCII)	
		08	1	00, 20 - 7E	Live Set Bank Name 9	0, 32 - 126 (ASCII)	
		09	1	00, 20 - 7E	Live Set Bank Name 10	0, 32 - 126 (ASCII)	
		0A	1	00, 20 - 7E	Live Set Bank Name 11	0, 32 - 126 (ASCII)	
		0B	1	00, 20 - 7E	Live Set Bank Name 12	0, 32 - 126 (ASCII)	
		0C	1	00, 20 - 7E	Live Set Bank Name 13	0, 32 - 126 (ASCII)	
		0D	1	00, 20 - 7E	Live Set Bank Name 14	0, 32 - 126 (ASCII)	
		0E	1	00, 20 - 7E	Live Set Bank Name 15	0, 32 - 126 (ASCII)	
		0F	1	00, 20 - 7E	Live Set Bank Name 16	0, 32 - 126 (ASCII)	
		10	1	00, 20 - 7E	Live Set Bank Name 17	0, 32 - 126 (ASCII)	
		11	1	00, 20 - 7E	Live Set Bank Name 18	0, 32 - 126 (ASCII)	
		12	1	00, 20 - 7E	Live Set Bank Name 19	0, 32 - 126 (ASCII)	
		13	1	00, 20 - 7E	Live Set Bank Name 20	0, 32 - 126 (ASCII)	

TOTAL SIZE = 20 14 (HEX)

Address	Size	Data Range (HEX)	Parameter Name	Description	Default (HEX)	Notes	
03	0p	00	1	00, 20 - 7E	Live Set Page Name 1	0, 32 - 126 (ASCII)	Initialized Page
		01	1	00, 20 - 7E	Live Set Page Name 2	0, 32 - 126 (ASCII)	
		02	1	00, 20 - 7E	Live Set Page Name 3	0, 32 - 126 (ASCII)	
		03	1	00, 20 - 7E	Live Set Page Name 4	0, 32 - 126 (ASCII)	
		04	1	00, 20 - 7E	Live Set Page Name 5	0, 32 - 126 (ASCII)	
		05	1	00, 20 - 7E	Live Set Page Name 6	0, 32 - 126 (ASCII)	
		06	1	00, 20 - 7E	Live Set Page Name 7	0, 32 - 126 (ASCII)	
		07	1	00, 20 - 7E	Live Set Page Name 8	0, 32 - 126 (ASCII)	
		08	1	00, 20 - 7E	Live Set Page Name 9	0, 32 - 126 (ASCII)	
		09	1	00, 20 - 7E	Live Set Page Name 10	0, 32 - 126 (ASCII)	
		0A	1	00, 20 - 7E	Live Set Page Name 11	0, 32 - 126 (ASCII)	
		0B	1	00, 20 - 7E	Live Set Page Name 12	0, 32 - 126 (ASCII)	
		0C	1	00, 20 - 7E	Live Set Page Name 13	0, 32 - 126 (ASCII)	
		0D	1	00, 20 - 7E	Live Set Page Name 14	0, 32 - 126 (ASCII)	
		0E	1	00, 20 - 7E	Live Set Page Name 15	0, 32 - 126 (ASCII)	
		0F	1	00, 20 - 7E	Live Set Page Name 16	0, 32 - 126 (ASCII)	
		10	1	00, 20 - 7E	Live Set Page Name 17	0, 32 - 126 (ASCII)	
		11	1	00, 20 - 7E	Live Set Page Name 18	0, 32 - 126 (ASCII)	
		12	1	00, 20 - 7E	Live Set Page Name 19	0, 32 - 126 (ASCII)	
		13	1	00, 20 - 7E	Live Set Page Name 20	0, 32 - 126 (ASCII)	

TOTAL SIZE = 20 14 (HEX)

p = Page number
00 - 0F Page 1 - 16

Address	Size	Data Range (HEX)	Parameter Name	Description	Default (HEX)	Notes	
04	ps	00	1	00, 20 - 7E	Live Set Slot Name 1	0, 32 - 126 (ASCII)	Initialized Slot
		01	1	00, 20 - 7E	Live Set Slot Name 2	0, 32 - 126 (ASCII)	
		02	1	00, 20 - 7E	Live Set Slot Name 3	0, 32 - 126 (ASCII)	
		03	1	00, 20 - 7E	Live Set Slot Name 4	0, 32 - 126 (ASCII)	
		04	1	00, 20 - 7E	Live Set Slot Name 5	0, 32 - 126 (ASCII)	
		05	1	00, 20 - 7E	Live Set Slot Name 6	0, 32 - 126 (ASCII)	
		06	1	00, 20 - 7E	Live Set Slot Name 7	0, 32 - 126 (ASCII)	
		07	1	00, 20 - 7E	Live Set Slot Name 8	0, 32 - 126 (ASCII)	
		08	1	00, 20 - 7E	Live Set Slot Name 9	0, 32 - 126 (ASCII)	
		09	1	00, 20 - 7E	Live Set Slot Name 10	0, 32 - 126 (ASCII)	
		0A	1	00, 20 - 7E	Live Set Slot Name 11	0, 32 - 126 (ASCII)	
		0B	1	00, 20 - 7E	Live Set Slot Name 12	0, 32 - 126 (ASCII)	
		0C	1	00, 20 - 7E	Live Set Slot Name 13	0, 32 - 126 (ASCII)	
		0D	1	00, 20 - 7E	Live Set Slot Name 14	0, 32 - 126 (ASCII)	
		0E	1	00, 20 - 7E	Live Set Slot Name 15	0, 32 - 126 (ASCII)	
		0F	1	00, 20 - 7E	Live Set Slot Name 16	0, 32 - 126 (ASCII)	
		10	1	00, 20 - 7E	Live Set Slot Name 17	0, 32 - 126 (ASCII)	
		11	1	00, 20 - 7E	Live Set Slot Name 18	0, 32 - 126 (ASCII)	
		12	1	00, 20 - 7E	Live Set Slot Name 19	0, 32 - 126 (ASCII)	
		13	1	00, 20 - 7E	Live Set Slot Name 20	0, 32 - 126 (ASCII)	
		14	1	00 - 0F	Live Set Slot Color	Black, Red, Yellow, Green, Blue, Azure, Pink, Orange, Purple, Sakura, Cream, Lime, Aqua, Beige, Mint, Lilac	00
		15	1	00 - 7F	Bank Select MSB	0 - 127	3F
		16	1	00 - 7F	Bank Select LSB	0 - 127	00
		17	1	00 - 7F	Performance Number	1 - 128	00
		18	1	00 - 7F	Performance Volume	0 - 127	64
		19	1	00 - 01	Slot Switch	Off, On	00

TOTAL SIZE = 26 1A (HEX)

p = Page number
00 - 07 Page 1 - 8
s = Slot number
00 - 0F Slot 1 - 16

Address	Size	Data Range (HEX)	Parameter Name	Description	Default (HEX)	Notes	
05	ps	00	1	00, 20 - 7E	Live Set Slot Name 1	0, 32 - 126 (ASCII)	Initialized Slot
		01	1	00, 20 - 7E	Live Set Slot Name 2	0, 32 - 126 (ASCII)	
		02	1	00, 20 - 7E	Live Set Slot Name 3	0, 32 - 126 (ASCII)	
		03	1	00, 20 - 7E	Live Set Slot Name 4	0, 32 - 126 (ASCII)	
		04	1	00, 20 - 7E	Live Set Slot Name 5	0, 32 - 126 (ASCII)	
		05	1	00, 20 - 7E	Live Set Slot Name 6	0, 32 - 126 (ASCII)	
		06	1	00, 20 - 7E	Live Set Slot Name 7	0, 32 - 126 (ASCII)	
		07	1	00, 20 - 7E	Live Set Slot Name 8	0, 32 - 126 (ASCII)	
		08	1	00, 20 - 7E	Live Set Slot Name 9	0, 32 - 126 (ASCII)	
		09	1	00, 20 - 7E	Live Set Slot Name 10	0, 32 - 126 (ASCII)	
		0A	1	00, 20 - 7E	Live Set Slot Name 11	0, 32 - 126 (ASCII)	
		0B	1	00, 20 - 7E	Live Set Slot Name 12	0, 32 - 126 (ASCII)	
		0C	1	00, 20 - 7E	Live Set Slot Name 13	0, 32 - 126 (ASCII)	
		0D	1	00, 20 - 7E	Live Set Slot Name 14	0, 32 - 126 (ASCII)	
		0E	1	00, 20 - 7E	Live Set Slot Name 15	0, 32 - 126 (ASCII)	
		0F	1	00, 20 - 7E	Live Set Slot Name 16	0, 32 - 126 (ASCII)	
		10	1	00, 20 - 7E	Live Set Slot Name 17	0, 32 - 126 (ASCII)	
		11	1	00, 20 - 7E	Live Set Slot Name 18	0, 32 - 126 (ASCII)	
		12	1	00, 20 - 7E	Live Set Slot Name 19	0, 32 - 126 (ASCII)	
		13	1	00, 20 - 7E	Live Set Slot Name 20	0, 32 - 126 (ASCII)	
		14	1	00 - 0F	Live Set Slot Color	Black, Red, Yellow, Green, Blue, Azure, Pink, Orange, Purple, Sakura, Cream, Lime, Aqua, Beige, Mint, Lilac	Black
		15	1	00 - 7F	Bank Select MSB	0 - 127	3F
		16	1	00 - 7F	Bank Select LSB	0 - 127	00
		17	1	00 - 7F	Performance Number	1 - 128	00
		18	1	00 - 7F	Performance Volume	0 - 127	64
		19	1	00 - 01	Slot Switch	Off, On	00

TOTAL SIZE = 26 1A (HEX)

p = Page number
00 - 07 Page 9 - 16
s = Slot number
00 - 0F Slot 1 - 16

MIDI PARAMETER CHANGE TABLE (PERFORMANCE COMMON)

Address	Size	Data Range (HEX)	Parameter Name	Description	Default (HEX)	Notes	
30	40	00	1	00, 20 - 7E	Performance Name 1	0, 32 - 126 (ASCII)	Initialized Perform
		01	1	00, 20 - 7E	Performance Name 2	0, 32 - 126 (ASCII)	
		02	1	00, 20 - 7E	Performance Name 3	0, 32 - 126 (ASCII)	
		03	1	00, 20 - 7E	Performance Name 4	0, 32 - 126 (ASCII)	
		04	1	00, 20 - 7E	Performance Name 5	0, 32 - 126 (ASCII)	
		05	1	00, 20 - 7E	Performance Name 6	0, 32 - 126 (ASCII)	
		06	1	00, 20 - 7E	Performance Name 7	0, 32 - 126 (ASCII)	
		07	1	00, 20 - 7E	Performance Name 8	0, 32 - 126 (ASCII)	
		08	1	00, 20 - 7E	Performance Name 9	0, 32 - 126 (ASCII)	
		09	1	00, 20 - 7E	Performance Name 10	0, 32 - 126 (ASCII)	
		0A	1	00, 20 - 7E	Performance Name 11	0, 32 - 126 (ASCII)	
		0B	1	00, 20 - 7E	Performance Name 12	0, 32 - 126 (ASCII)	
		0C	1	00, 20 - 7E	Performance Name 13	0, 32 - 126 (ASCII)	
		0D	1	00, 20 - 7E	Performance Name 14	0, 32 - 126 (ASCII)	
		0E	1	00, 20 - 7E	Performance Name 15	0, 32 - 126 (ASCII)	
		0F	1	00, 20 - 7E	Performance Name 16	0, 32 - 126 (ASCII)	
		10	1	00, 20 - 7E	Performance Name 17	0, 32 - 126 (ASCII)	
		11	1	00, 20 - 7E	Performance Name 18	0, 32 - 126 (ASCII)	
		12	1	00, 20 - 7E	Performance Name 19	0, 32 - 126 (ASCII)	
		13	1	00, 20 - 7E	Performance Name 20	0, 32 - 126 (ASCII)	
		14	1		reserved		
		15	1		reserved		
		16	1		reserved		
		17	1		reserved		
		18	1		reserved		
		19	1		reserved		
		1A	1		reserved		
		1B	1		reserved		
		1C	1		reserved		
		1D	1		reserved		
		1E	1	00 - 06	Knob Function Select	0= Tone, 1=EQ/FX, 2=ARP/MS, 3=Assign, 4=Pan, 5=Variation, 6=Reverb	03
		1F	1	01 - 7F	Performance Pan	L63 - C - R63	40
		20	1	00 - 02	Control Function Select	Performance Control, Part Control, Elem/Op Control	00
		21	1	00 - 7F	AEG Attack Time	-64 - +63	40
		22	1	00 - 7F	AEG Decay Time	-64 - +63	40
		23	1	00 - 7F	AEG Sustain Level	-64 - +63	40
		24	1	00 - 7F	AEG Release Time	-64 - +63	40
		25	1	00 - 7F	FEG Attack Time	-64 - +63	40
		26	1	00 - 7F	FEG Decay Time	-64 - +63	40
		27	1		reserved		
		28	1	00 - 7F	FEG Release Time	-64 - +63	40
		29	1	00 - 7F	FEG Depth	-64 - +63	40
		2A	1	00 - 7F	Cutoff Frequency	-64 - +63	40
		2B	1	00 - 7F	Resonance	-64 - +63	40
		2C	2	00 - 02 00 - 7F	Tempo	5 - 300 1st bit6-0 → bit13-7 2nd bit6-0 → bit6-0	00 5A
		2E	1		reserved		
		2F	1		reserved		
		30	1		reserved		
		31	1		reserved		
		32	1		reserved		
		33	1		reserved		
		34	1		reserved		
		35	1		reserved		
		36	1		reserved		
		37	1		reserved		
		38	1	00 - 7F	Performance Volume	0 - 127	7F
		39	1	00 - 7F	Portamento Time	-64 - +63	40
		3A	1	00 - 01	Portamento Switch	Off, On	01
		3B	1	00 - 7F	USB Main Monitor Volume	0 - 127	7F
		3C	1	00 - 7F	USB Assign Monitor Volume	0 - 127	7F
		3D	1	00 - 01	Assignable Switch 1 Mode	Momentary, Latch	01
		3E	1	00 - 01	Assignable Switch 2 Mode	Momentary, Latch	01
		3F	1	00 - 01	Motion Seq Hold Switch Mode	Momentary, Latch	01
		40	1		reserved		
		41	1	00 - 01	Ribbon Controller Mode	Hold, Reset	01
		42	1		reserved		
		43	1	00 - 5F	Ribbon Controller Control Number	Off, 1 - 95	10
		44	1	00 - 5F	Breath Controller Control Number	Off, 1 - 95	02
		45	1	00 - 605F	Foot Controller 1 Control Number	Off, 1 - 95, Super Knob	0B
		46	1	00 - 605F	Foot Controller 2 Control Number	Off, 1 - 95, Super Knob	04

Address	Size	Data Range (HEX)	Parameter Name	Description	Default (HEX)	Notes	
		47	1	00 - 5F	Assignable Switch 1 Control Number	Off, 1 - 95	56
		48	1	00 - 5F	Assignable Switch 2 Control Number	Off, 1 - 95	57
		49	1	00 - 5F	Motion Seq Hold Switch Control Number	Off, 1 - 95	58
		4A	1	00 - 5F	Motion Seq Trigger Switch Control Number	Off, 1 - 95	59
		4B	1	00 - 5F	Assignable Knob 1 Control Number	Off, 1 - 95	11
		4C	1	00 - 5F	Assignable Knob 2 Control Number	Off, 1 - 95	12
		4D	1	00 - 5F	Assignable Knob 3 Control Number	Off, 1 - 95	13
		4E	1	00 - 5F	Assignable Knob 4 Control Number	Off, 1 - 95	14
		4F	1	00 - 5F	Assignable Knob 5 Control Number	Off, 1 - 95	15
		50	1	00 - 5F	Assignable Knob 6 Control Number	Off, 1 - 95	16
		51	1	00 - 5F	Assignable Knob 7 Control Number	Off, 1 - 95	17
		52	1	00 - 5F	Assignable Knob 8 Control Number	Off, 1 - 95	18
		53	1	00 - 7F	Assignable Knob 1 Value	0 - 127	40
		54	1	00 - 7F	Assignable Knob 2 Value	0 - 127	40
		55	1	00 - 7F	Assignable Knob 3 Value	0 - 127	40
		56	1	00 - 7F	Assignable Knob 4 Value	0 - 127	40
		57	1	00 - 7F	Assignable Knob 5 Value	0 - 127	40
		58	1	00 - 7F	Assignable Knob 6 Value	0 - 127	40
		59	1	00 - 7F	Assignable Knob 7 Value	0 - 127	40
		5A	1	00 - 7F	Assignable Knob 8 Value	0 - 127	40
		5B	2	00 - 01 00 - 7F	Swing Offset	-120 - 0 - +120 1st bit6-0 → bit13-7 2nd bit6-0 → bit6-0	01 00
		5D	1	00 - 09	Unit Multiply	50%, 66%, 75%, 100%, 133%, 150%, 200%, 266%, 300%, 400%	03

TOTAL SIZE = 94 5E (HEX)

Address	Size	Data Range (HEX)	Parameter Name	Description	Default (HEX)	Notes	
30	41	00	2	00 - 7F 00 - 7F	Reverb Type	Refer to Effect Parameter List	01 00
		02	1	00 - 7F	Reverb Preset Number		00
		03	2	00 - 7F 00 - 7F	Reverb Parameter 1 MSB Reverb Parameter 1 LSB		Init value for Rev-X Hall / Basic
		05	2	00 - 7F 00 - 7F	Reverb Parameter 2 MSB Reverb Parameter 2 LSB		Init value for Rev-X Hall / Basic
		07	2	00 - 7F 00 - 7F	Reverb Parameter 3 MSB Reverb Parameter 3 LSB		Init value for Rev-X Hall / Basic
		09	2	00 - 7F 00 - 7F	Reverb Parameter 4 MSB Reverb Parameter 4 LSB		Init value for Rev-X Hall / Basic
		0B	2	00 - 7F 00 - 7F	Reverb Parameter 5 MSB Reverb Parameter 5 LSB		Init value for Rev-X Hall / Basic
		0D	2	00 - 7F 00 - 7F	Reverb Parameter 6 MSB Reverb Parameter 6 LSB		Init value for Rev-X Hall / Basic
		0F	2	00 - 7F 00 - 7F	Reverb Parameter 7 MSB Reverb Parameter 7 LSB		Init value for Rev-X Hall / Basic
		11	2	00 - 7F 00 - 7F	Reverb Parameter 8 MSB Reverb Parameter 8 LSB		Init value for Rev-X Hall / Basic
		13	2	00 - 7F 00 - 7F	Reverb Parameter 9 MSB Reverb Parameter 9 LSB		Init value for Rev-X Hall / Basic
		15	2	00 - 7F 00 - 7F	Reverb Parameter 10 MSB Reverb Parameter 10 LSB		Init value for Rev-X Hall / Basic
		17	2	00 - 7F 00 - 7F	Reverb Parameter 11 MSB Reverb Parameter 11 LSB		Init value for Rev-X Hall / Basic
		19	2	00 - 7F 00 - 7F	Reverb Parameter 12 MSB Reverb Parameter 12 LSB		Init value for Rev-X Hall / Basic
		1B	2	00 - 7F 00 - 7F	Reverb Parameter 13 MSB Reverb Parameter 13 LSB		Init value for Rev-X Hall / Basic
		1D	2	00 - 7F 00 - 7F	Reverb Parameter 14 MSB Reverb Parameter 14 LSB		Init value for Rev-X Hall / Basic
		1F	2	00 - 7F 00 - 7F	Reverb Parameter 15 MSB Reverb Parameter 15 LSB		Init value for Rev-X Hall / Basic
		21	2	00 - 7F 00 - 7F	Reverb Parameter 16 MSB Reverb Parameter 16 LSB		Init value for Rev-X Hall / Basic
		23	2	00 - 7F 00 - 7F	Reverb Parameter 17 MSB Reverb Parameter 17 LSB		Init value for Rev-X Hall / Basic
		25	2	00 - 7F 00 - 7F	Reverb Parameter 18 MSB Reverb Parameter 18 LSB		Init value for Rev-X Hall / Basic
		27	2	00 - 7F 00 - 7F	Reverb Parameter 19 MSB Reverb Parameter 19 LSB		Init value for Rev-X Hall / Basic
		29	2	00 - 7F 00 - 7F	Reverb Parameter 20 MSB Reverb Parameter 20 LSB		Init value for Rev-X Hall / Basic

Address	Size	Data Range (HEX)	Parameter Name	Description	Default (HEX)	Notes
	2B	2	00 - 7F 00 - 7F	Reverb Parameter 21 MSB Reverb Parameter 21 LSB	:	Init value for Rev-X Hall / Basic
	2D	2	00 - 7F 00 - 7F	Reverb Parameter 22 MSB Reverb Parameter 22 LSB	:	Init value for Rev-X Hall / Basic
	2F	2	00 - 7F 00 - 7F	Reverb Parameter 23 MSB Reverb Parameter 23 LSB	:	Init value for Rev-X Hall / Basic
	31	2	00 - 7F 00 - 7F	Reverb Parameter 24 MSB Reverb Parameter 24 LSB	:	Init value for Rev-X Hall / Basic
	33	2		reserved		
	35	2		reserved		
	37	2		reserved		
	39	2		reserved		
	3B	2		reserved		
	3D	2		reserved		
	3F	2		reserved		
	41	2		reserved		
	43	1		reserved		
	44	1	00 - 7F	Reverb Return	0 - 127	40
	45	1	01 - 7F	Reverb Pan	L63 - C - R63	40
	46	1	00 - 01	Reverb Switch	Off, On	01

TOTAL SIZE = 71 47 (HEX)

Address	Size	Data Range (HEX)	Parameter Name	Description	Default (HEX)	Notes		
30	42	00	2	00 - 7F 00 - 7F	Variation Type	Refer to Effect Parameter List	03 00	
	02	1	00 - 7F	Variation Preset Number		00		
	03	2	00 - 7F 00 - 7F	Variation Parameter 1 MSB Variation Parameter 1 LSB	:	Init value for G Chorus / Basic		
	05	2	00 - 7F 00 - 7F	Variation Parameter 2 MSB Variation Parameter 2 LSB	:	Init value for G Chorus / Basic		
	07	2	00 - 7F 00 - 7F	Variation Parameter 3 MSB Variation Parameter 3 LSB	:	Init value for G Chorus / Basic		
	09	2	00 - 7F 00 - 7F	Variation Parameter 4 MSB Variation Parameter 4 LSB	:	Init value for G Chorus / Basic		
	0B	2	00 - 7F 00 - 7F	Variation Parameter 5 MSB Variation Parameter 5 LSB	:	Init value for G Chorus / Basic		
	0D	2	00 - 7F 00 - 7F	Variation Parameter 6 MSB Variation Parameter 6 LSB	:	Init value for G Chorus / Basic		
	0F	2	00 - 7F 00 - 7F	Variation Parameter 7 MSB Variation Parameter 7 LSB	:	Init value for G Chorus / Basic		
	11	2	00 - 7F 00 - 7F	Variation Parameter 8 MSB Variation Parameter 8 LSB	:	Init value for G Chorus / Basic		
	13	2	00 - 7F 00 - 7F	Variation Parameter 9 MSB Variation Parameter 9 LSB	:	Init value for G Chorus / Basic		
	15	2	00 - 7F 00 - 7F	Variation Parameter 10 MSB Variation Parameter 10 LSB	:	Init value for G Chorus / Basic		
	17	2	00 - 7F 00 - 7F	Variation Parameter 11 MSB Variation Parameter 11 LSB	:	Init value for G Chorus / Basic		
	19	2	00 - 7F 00 - 7F	Variation Parameter 12 MSB Variation Parameter 12 LSB	:	Init value for G Chorus / Basic		
	1B	2	00 - 7F 00 - 7F	Variation Parameter 13 MSB Variation Parameter 13 LSB	:	Init value for G Chorus / Basic		
	1D	2	00 - 7F 00 - 7F	Variation Parameter 14 MSB Variation Parameter 14 LSB	:	Init value for G Chorus / Basic		
	1F	2	00 - 7F 00 - 7F	Variation Parameter 15 MSB Variation Parameter 15 LSB	:	Init value for G Chorus / Basic		
	21	2	00 - 7F 00 - 7F	Variation Parameter 16 MSB Variation Parameter 16 LSB	:	Init value for G Chorus / Basic		
	23	2	00 - 7F 00 - 7F	Variation Parameter 17 MSB Variation Parameter 17 LSB	:	Init value for G Chorus / Basic		
	25	2	00 - 7F 00 - 7F	Variation Parameter 18 MSB Variation Parameter 18 LSB	:	Init value for G Chorus / Basic		
	27	2	00 - 7F 00 - 7F	Variation Parameter 19 MSB Variation Parameter 19 LSB	:	Init value for G Chorus / Basic		
	29	2	00 - 7F 00 - 7F	Variation Parameter 20 MSB Variation Parameter 20 LSB	:	Init value for G Chorus / Basic		
	2B	2	00 - 7F 00 - 7F	Variation Parameter 21 MSB Variation Parameter 21 LSB	:	Init value for G Chorus / Basic		
	2D	2	00 - 7F 00 - 7F	Variation Parameter 22 MSB Variation Parameter 22 LSB	:	Init value for G Chorus / Basic		
	2F	2	00 - 7F 00 - 7F	Variation Parameter 23 MSB Variation Parameter 23 LSB	:	Init value for G Chorus / Basic		
	31	2	00 - 7F 00 - 7F	Variation Parameter 24 MSB Variation Parameter 24 LSB	:	Init value for G Chorus / Basic		
	33	2		reserved				
	35	2		reserved				
	37	2		reserved				
	39	2		reserved				
	3B	2		reserved				
	3D	2		reserved				
	3F	2		reserved				
	41	2		reserved				
	43	1	00 - 11, 7F	Variation Side Chain Part	0: Part 1, 1: Part 2 - 15: Part 16, 16: A/D, 17: Master, 127: Off	127		
	44	1	00 - 7F	Variation Return	0 - 127	60		

Address	Size	Data Range (HEX)	Parameter Name	Description	Default (HEX)	Notes
	45	1	01 - 7F	Variation Pan	L63 - C - R63	40
	46	1	00 - 7F	Send Variation To Reverb	0 - 127	00
	47	1	00 - 01	Variation Switch	Off, On	01

TOTAL SIZE = 72 48 (HEX)

Address	Size	Data Range (HEX)	Parameter Name	Description	Default (HEX)	Notes		
30	43	00	2	00 - 7F 00 - 7F	Insertion-A Type	Refer to Effect Parameter List	00 00	For A/D Part
	02	1	00 - 7F	Insertion-A Preset Number		00		
	03	2	00 - 7F 00 - 7F	Insertion-A Parameter 1 MSB Insertion-A Parameter 1 LSB	:	00 00		
	05	2	00 - 7F 00 - 7F	Insertion-A Parameter 2 MSB Insertion-A Parameter 2 LSB	:	00 00		
	07	2	00 - 7F 00 - 7F	Insertion-A Parameter 3 MSB Insertion-A Parameter 3 LSB	:	00 00		
	09	2	00 - 7F 00 - 7F	Insertion-A Parameter 4 MSB Insertion-A Parameter 4 LSB	:	00 00		
	0B	2	00 - 7F 00 - 7F	Insertion-A Parameter 5 MSB Insertion-A Parameter 5 LSB	:	00 00		
	0D	2	00 - 7F 00 - 7F	Insertion-A Parameter 6 MSB Insertion-A Parameter 6 LSB	:	00 00		
	0F	2	00 - 7F 00 - 7F	Insertion-A Parameter 7 MSB Insertion-A Parameter 7 LSB	:	00 00		
	11	2	00 - 7F 00 - 7F	Insertion-A Parameter 8 MSB Insertion-A Parameter 8 LSB	:	00 00		
	13	2	00 - 7F 00 - 7F	Insertion-A Parameter 9 MSB Insertion-A Parameter 9 LSB	:	00 00		
	15	2	00 - 7F 00 - 7F	Insertion-A Parameter 10 MSB Insertion-A Parameter 10 LSB	:	00 00		
	17	2	00 - 7F 00 - 7F	Insertion-A Parameter 11 MSB Insertion-A Parameter 11 LSB	:	00 00		
	19	2	00 - 7F 00 - 7F	Insertion-A Parameter 12 MSB Insertion-A Parameter 12 LSB	:	00 00		
	1B	2	00 - 7F 00 - 7F	Insertion-A Parameter 13 MSB Insertion-A Parameter 13 LSB	:	00 00		
	1D	2	00 - 7F 00 - 7F	Insertion-A Parameter 14 MSB Insertion-A Parameter 14 LSB	:	00 00		
	1F	2	00 - 7F 00 - 7F	Insertion-A Parameter 15 MSB Insertion-A Parameter 15 LSB	:	00 00		
	21	2	00 - 7F 00 - 7F	Insertion-A Parameter 16 MSB Insertion-A Parameter 16 LSB	:	00 00		
	23	2	00 - 7F 00 - 7F	Insertion-A Parameter 17 MSB Insertion-A Parameter 17 LSB	:	00 00		
	25	2	00 - 7F 00 - 7F	Insertion-A Parameter 18 MSB Insertion-A Parameter 18 LSB	:	00 00		
	27	2	00 - 7F 00 - 7F	Insertion-A Parameter 19 MSB Insertion-A Parameter 19 LSB	:	00 00		
	29	2	00 - 7F 00 - 7F	Insertion-A Parameter 20 MSB Insertion-A Parameter 20 LSB	:	00 00		
	2B	2	00 - 7F 00 - 7F	Insertion-A Parameter 21 MSB Insertion-A Parameter 21 LSB	:	00 00		
	2D	2	00 - 7F 00 - 7F	Insertion-A Parameter 22 MSB Insertion-A Parameter 22 LSB	:	00 00		
	2F	2	00 - 7F 00 - 7F	Insertion-A Parameter 23 MSB Insertion-A Parameter 23 LSB	:	00 00		
	31	2	00 - 7F 00 - 7F	Insertion-A Parameter 24 MSB Insertion-A Parameter 24 LSB	:	00 00		
	33	2		reserved				
	35	2		reserved				
	37	2		reserved				
	39	2		reserved				
	3B	2		reserved				
	3D	2		reserved				
	3F	2		reserved				
	41	2		reserved				
	43	1	00 - 11, 7F	Insertion-A Side Chain Part	0: Part 1, 1: Part 2 - 15: Part 16, 16: A/D, 17: Master, 127: Off	127		

TOTAL SIZE = 68 44 (HEX)

Address	Size	Data Range (HEX)	Parameter Name	Description	Default (HEX)	Notes
30 44 00	2	00 - 7F 00 - 7F	Insertion-B Type	Refer to Effect Parameter List	00 00	For A/D Part
	02	1 00 - 7F	Insertion-B Preset Number		00	
	03	2 00 - 7F 00 - 7F	Insertion-B Parameter 1 MSB Insertion-B Parameter 1 LSB	:	00 00	:
	05	2 00 - 7F 00 - 7F	Insertion-B Parameter 2 MSB Insertion-B Parameter 2 LSB	:	00 00	:
	07	2 00 - 7F 00 - 7F	Insertion-B Parameter 3 MSB Insertion-B Parameter 3 LSB	:	00 00	:
	09	2 00 - 7F 00 - 7F	Insertion-B Parameter 4 MSB Insertion-B Parameter 4 LSB	:	00 00	:
	0B	2 00 - 7F 00 - 7F	Insertion-B Parameter 5 MSB Insertion-B Parameter 5 LSB	:	00 00	:
	0D	2 00 - 7F 00 - 7F	Insertion-B Parameter 6 MSB Insertion-B Parameter 6 LSB	:	00 00	:
	0F	2 00 - 7F 00 - 7F	Insertion-B Parameter 7 MSB Insertion-B Parameter 7 LSB	:	00 00	:
	11	2 00 - 7F 00 - 7F	Insertion-B Parameter 8 MSB Insertion-B Parameter 8 LSB	:	00 00	:
	13	2 00 - 7F 00 - 7F	Insertion-B Parameter 9 MSB Insertion-B Parameter 9 LSB	:	00 00	:
	15	2 00 - 7F 00 - 7F	Insertion-B Parameter 10 MSB Insertion-B Parameter 10 LSB	:	00 00	:
	17	2 00 - 7F 00 - 7F	Insertion-B Parameter 11 MSB Insertion-B Parameter 11 LSB	:	00 00	:
	19	2 00 - 7F 00 - 7F	Insertion-B Parameter 12 MSB Insertion-B Parameter 12 LSB	:	00 00	:
	1B	2 00 - 7F 00 - 7F	Insertion-B Parameter 13 MSB Insertion-B Parameter 13 LSB	:	00 00	:
	1D	2 00 - 7F 00 - 7F	Insertion-B Parameter 14 MSB Insertion-B Parameter 14 LSB	:	00 00	:
	1F	2 00 - 7F 00 - 7F	Insertion-B Parameter 15 MSB Insertion-B Parameter 15 LSB	:	00 00	:
	21	2 00 - 7F 00 - 7F	Insertion-B Parameter 16 MSB Insertion-B Parameter 16 LSB	:	00 00	:
	23	2 00 - 7F 00 - 7F	Insertion-B Parameter 17 MSB Insertion-B Parameter 17 LSB	:	00 00	:
	25	2 00 - 7F 00 - 7F	Insertion-B Parameter 18 MSB Insertion-B Parameter 18 LSB	:	00 00	:
	27	2 00 - 7F 00 - 7F	Insertion-B Parameter 19 MSB Insertion-B Parameter 19 LSB	:	00 00	:
	29	2 00 - 7F 00 - 7F	Insertion-B Parameter 20 MSB Insertion-B Parameter 20 LSB	:	00 00	:
	2B	2 00 - 7F 00 - 7F	Insertion-B Parameter 21 MSB Insertion-B Parameter 21 LSB	:	00 00	:
	2D	2 00 - 7F 00 - 7F	Insertion-B Parameter 22 MSB Insertion-B Parameter 22 LSB	:	00 00	:
	2F	2 00 - 7F 00 - 7F	Insertion-B Parameter 23 MSB Insertion-B Parameter 23 LSB	:	00 00	:
	31	2 00 - 7F 00 - 7F	Insertion-B Parameter 24 MSB Insertion-B Parameter 24 LSB	:	00 00	:
	33	2	reserved			
	35	2	reserved			
	37	2	reserved			
	39	2	reserved			
	3B	2	reserved			
	3D	2	reserved			
	3F	2	reserved			
	41	2	reserved			
	43	1 00 - 11, 7F	Insertion-B Side Chain Part	0: Part 1, 1: Part 2 - 15: Part 16, 16: A/D, 17: Master, 127: Off	127	

TOTAL SIZE = 68 44 (HEX)

Address	Size	Data Range (HEX)	Parameter Name	Description	Default (HEX)	Notes
30 45 00	1	34 - 4C	Master EQ Low Gain	-12 - +12 [dB]	40	
	01	1 04 - 28	Master EQ Low Frequency	32 - 2000 [Hz]	0C	
	02	1 01 - 78	Master EQ Low Q	0.1 - 12.0	07	This is not available when "shelving" is selected.
	03	1 00 - 01	Master EQ Low Shape	Shelf, Peak	00	
	04	1 34 - 4C	Master EQ Low Mid Gain	-12 - +12 [dB]	40	
	05	1 0E - 36	Master EQ Low Mid Frequency	100 - 10.0 [kHz]	14	
	06	1 01 - 78	Master EQ Low Mid Q	0.1 - 12.0	07	
	07	1	reserved			
	08	1 34 - 4C	Master EQ Mid Gain	-12 - +12 [dB]	40	
	09	1 0E - 36	Master EQ Mid Frequency	100 - 10.0 [kHz]	1C	
	0A	1 01 - 78	Master EQ Mid Q	0.1 - 12.0	07	
	0B	1	reserved			
	0C	1 34 - 4C	Master EQ High Mid Gain	-12 - +12 [dB]	40	
	0D	1 0E - 36	Master EQ High Mid Frequency	100 - 10.0 [kHz]	2C	
	0E	1 01 - 78	Master EQ High Mid Q	0.1 - 12.0	07	
	0F	1	reserved			

Address	Size	Data Range (HEX)	Parameter Name	Description	Default (HEX)	Notes
	10	1 34 - 4C	Master EQ High Gain	-12 - +12 [dB]	40	
	11	1 1C - 3A	Master EQ High Frequency	0.5 - 16.0 [kHz]	34	
	12	1 01 - 78	Master EQ High Q	0.1 - 12.0	07	This is not available when "shelving" is selected.
	13	1 00 - 01	Master EQ High Shape	Shelf, Peak	00	
	14	1 00 - 01	Master EQ Switch	Off, On	01	

TOTAL SIZE = 21 15 (HEX)

Address	Size	Data Range (HEX)	Parameter Name	Description	Default (HEX)	Notes
30 46 00	2	00 - 7F 00 - 7F	Master Effect Type	Refer to Effect Parameter List	08 20	
	02	1 00 - 7F	Master Effect Preset Number		00	
	03	2 00 - 7F 00 - 7F	Master Effect Parameter 1 MSB Master Effect Parameter 1 LSB	:		Init value for Multi Band Comp / Basic
	05	2 00 - 7F 00 - 7F	Master Effect Parameter 2 MSB Master Effect Parameter 2 LSB	:		Init value for Multi Band Comp / Basic
	07	2 00 - 7F 00 - 7F	Master Effect Parameter 3 MSB Master Effect Parameter 3 LSB	:		Init value for Multi Band Comp / Basic
	09	2 00 - 7F 00 - 7F	Master Effect Parameter 4 MSB Master Effect Parameter 4 LSB	:		Init value for Multi Band Comp / Basic
	0B	2 00 - 7F 00 - 7F	Master Effect Parameter 5 MSB Master Effect Parameter 5 LSB	:		Init value for Multi Band Comp / Basic
	0D	2 00 - 7F 00 - 7F	Master Effect Parameter 6 MSB Master Effect Parameter 6 LSB	:		Init value for Multi Band Comp / Basic
	0F	2 00 - 7F 00 - 7F	Master Effect Parameter 7 MSB Master Effect Parameter 7 LSB	:		Init value for Multi Band Comp / Basic
	11	2 00 - 7F 00 - 7F	Master Effect Parameter 8 MSB Master Effect Parameter 8 LSB	:		Init value for Multi Band Comp / Basic
	13	2 00 - 7F 00 - 7F	Master Effect Parameter 9 MSB Master Effect Parameter 9 LSB	:		Init value for Multi Band Comp / Basic
	15	2 00 - 7F 00 - 7F	Master Effect Parameter 10 MSB Master Effect Parameter 10 LSB	:		Init value for Multi Band Comp / Basic
	17	2 00 - 7F 00 - 7F	Master Effect Parameter 11 MSB Master Effect Parameter 11 LSB	:		Init value for Multi Band Comp / Basic
	19	2 00 - 7F 00 - 7F	Master Effect Parameter 12 MSB Master Effect Parameter 12 LSB	:		Init value for Multi Band Comp / Basic
	1B	2 00 - 7F 00 - 7F	Master Effect Parameter 13 MSB Master Effect Parameter 13 LSB	:		Init value for Multi Band Comp / Basic
	1D	2 00 - 7F 00 - 7F	Master Effect Parameter 14 MSB Master Effect Parameter 14 LSB	:		Init value for Multi Band Comp / Basic
	1F	2 00 - 7F 00 - 7F	Master Effect Parameter 15 MSB Master Effect Parameter 15 LSB	:		Init value for Multi Band Comp / Basic
	21	2 00 - 7F 00 - 7F	Master Effect Parameter 16 MSB Master Effect Parameter 16 LSB	:		Init value for Multi Band Comp / Basic
	23	2 00 - 7F 00 - 7F	Master Effect Parameter 17 MSB Master Effect Parameter 17 LSB	:		Init value for Multi Band Comp / Basic
	25	2 00 - 7F 00 - 7F	Master Effect Parameter 18 MSB Master Effect Parameter 18 LSB	:		Init value for Multi Band Comp / Basic
	27	2 00 - 7F 00 - 7F	Master Effect Parameter 19 MSB Master Effect Parameter 19 LSB	:		Init value for Multi Band Comp / Basic
	29	2 00 - 7F 00 - 7F	Master Effect Parameter 20 MSB Master Effect Parameter 20 LSB	:		Init value for Multi Band Comp / Basic
	2B	2 00 - 7F 00 - 7F	Master Effect Parameter 21 MSB Master Effect Parameter 21 LSB	:		Init value for Multi Band Comp / Basic
	2D	2 00 - 7F 00 - 7F	Master Effect Parameter 22 MSB Master Effect Parameter 22 LSB	:		Init value for Multi Band Comp / Basic
	2F	2 00 - 7F 00 - 7F	Master Effect Parameter 23 MSB Master Effect Parameter 23 LSB	:		Init value for Multi Band Comp / Basic
	31	2 00 - 7F 00 - 7F	Master Effect Parameter 24 MSB Master Effect Parameter 24 LSB	:		Init value for Multi Band Comp / Basic
	33	2	reserved			
	35	2	reserved			
	37	2	reserved			
	39	2	reserved			
	3B	2	reserved			
	3D	2	reserved			
	3F	2	reserved			

Address	Size	Data Range (HEX)	Parameter Name	Description	Default (HEX)	Notes
	41	2		reserved		
	43	1	00 – 11, 7F	Master Effect Side Chain Part	0: Part 1, 1: Part 2 – 15: Part 16, 16: A/D, 17: Master, 127: Off	127
	44	1	10 – 70	Master Effect Envelope Follower Gain	-24dB – 0dB – +24dB	40
	45	1	00 – 13	Master Effect Envelope Follower Attack	1ms – 40ms	10
	46	1	00 – 0F	Master Effect Envelope Follower Release	10ms – 680ms	07
	47	1	00 – 01	Master Effect Switch	Off, On	00

TOTAL SIZE = 72 48 (HEX)

Address	Size	Data Range (HEX)	Parameter Name	Description	Default (HEX)	Notes		
30	47	00	1	00 – 07	Arpeggio Select	1 – 8	00	
	01	2			reserved			
	03	1	00 – 01	Arpeggio Master Switch	Off, On	00		
	04	1	00 – 07	Arpeggio Synchro Quantize Value	Off, 60, 80, 120, 160, 240, 320, 480	00		
	05	2			reserved			
	07	2	00 – 01 00 – 7F	Arpeggio Gate Time Rate Offset	-100 – 0 – +100 1st bit6-0 → bit13-7 2nd bit6-0 → bit6-0	01 00		
	09	2	00 – 01 00 – 7F	Arpeggio Velocity Rate Offset	:	01 00		
	0B	2			reserved			

TOTAL SIZE = 13 0D (HEX)

Address	Size	Data Range (HEX)	Parameter Name	Description	Default (HEX)	Notes		
30	48	00	1	00 – 01	Motion Seq Master Switch	Off, On	00	
	01	1	00 – 07	Motion Seq Select	1 – 8	01		
	02	1	00 – 7F	Motion Seq Amplitude Performance Offset	-64 – +63	40		
	03	1	0E – 72	Motion Seq Pulse Shape Performance Offset	-100, -98 – 0 – +98, +100	40		
	04	1	00 – 7F	Motion Seq Smoothness Performance Offset	-64 – +63	40		
	05	1	00 – 7F	Motion Seq Random Performance Offset	-64 – +63	40		

TOTAL SIZE = 6 06 (HEX)

Address	Size	Data Range (HEX)	Parameter Name	Description	Default (HEX)	Notes		
30	49	00	1	00 – 01	AD Part Motion Seq Lane 1 Switch	Off, On	00	
	01	1	00 – 01	AD Part Motion Seq Lane 1 FX Receive	Off, On	00		
	02	1	00 – 01	AD Part Motion Seq Lane 1 Trigger Receive	Off, On	00		
	03	1	00 – 03	AD Part Motion Seq Lane 1 Sync	Off, Tempo, Beat, Arp	00		
	04	1	00 – 7F	AD Part Motion Seq Lane 1 Speed	0 – 127	3F	This is available only when Sync is set to Off.	
	05	1	00 – 11	AD Part Motion Seq Lane 1 Unit	50%, 66%, 75%, 100%, 133%, 150%, 200%, 266%, 300%, 400%, 600%, 800%, 1200%, 1600%, 2400%, 3200%, 6400%, Common	03	This is not available when Sync is set to Off.	
	06	1	00 – 02	AD Part Motion Seq Lane 1 Key On Reset	Off, Each-On, 1st-On	00	This is not available when Sync is set to Arp.	
	07	1	00 – 01	AD Part Motion Seq Lane 1 Loop	Off, On	01		
	08	1	01 – 7F	AD Part Motion Seq Lane 1 Velocity Limit Low	1 – 127	01		
	09	1	01 – 7F	AD Part Motion Seq Lane 1 Velocity Limit High	1 – 127	7F		
	0A	1		reserved				
	0B	1		reserved				
	0C	1		reserved				
	0D	1		reserved				
	0E	1		reserved				
	0F	1		reserved				
	10	1	00 – 01	AD Part Motion Seq Lane 2 Switch	Off, On	00		
	11	1	00 – 01	AD Part Motion Seq Lane 2 FX Receive	Off, On	00		

Address	Size	Data Range (HEX)	Parameter Name	Description	Default (HEX)	Notes	
	12	1	00 – 01	AD Part Motion Seq Lane 2 Trigger Receive	Off, On	00	
	13	1	00 – 04	AD Part Motion Seq Lane 2 Sync	Off, Tempo, Beat, Arp, Lane 1	00	
	14	1	00 – 7F	AD Part Motion Seq Lane 2 Speed	0 – 127	3F	This is available only when Sync is set to Off.
	15	1	00 – 11	AD Part Motion Seq Lane 2 Unit	50%, 66%, 75%, 100%, 133%, 150%, 200%, 266%, 300%, 400%, 600%, 800%, 1200%, 1600%, 2400%, 3200%, 6400%, Common	03	This is not available when Sync is set to Off.
	16	1	00 – 02	AD Part Motion Seq Lane 2 Key On Reset	Off, Each-On, 1st-On	00	This is not available when Sync is set to Arp.
	17	1	00 – 01	AD Part Motion Seq Lane 2 Loop	Off, On	01	
	18	1	01 – 7F	AD Part Motion Seq Lane 2 Velocity Limit Low	1 – 127	01	
	19	1	01 – 7F	AD Part Motion Seq Lane 2 Velocity Limit High	1 – 127	7F	
	1A	1		reserved			
	1B	1		reserved			
	1C	1		reserved			
	1D	1		reserved			
	1E	1		reserved			
	1F	1		reserved			
	20	1	00 – 01	AD Part Motion Seq Lane 3 Switch	Off, On	00	
	21	1	00 – 01	AD Part Motion Seq Lane 3 FX Receive	Off, On	00	
	22	1	00 – 01	AD Part Motion Seq Lane 3 Trigger Receive	Off, On	00	
	23	1	00 – 04	AD Part Motion Seq Lane 3 Sync	Off, Tempo, Beat, Arp, Lane 1	00	
	24	1	00 – 7F	AD Part Motion Seq Lane 3 Speed	0 – 127	3F	This is available only when Sync is set to Off.
	25	1	00 – 11	AD Part Motion Seq Lane 3 Unit	50%, 66%, 75%, 100%, 133%, 150%, 200%, 266%, 300%, 400%, 600%, 800%, 1200%, 1600%, 2400%, 3200%, 6400%, Common	03	This is not available when Sync is set to Off.
	26	1	00 – 02	AD Part Motion Seq Lane 3 Key On Reset	Off, Each-On, 1st-On	00	This is not available when Sync is set to Arp.
	27	1	00 – 01	AD Part Motion Seq Lane 3 Loop	Off, On	01	
	28	1	01 – 7F	AD Part Motion Seq Lane 3 Velocity Limit Low	1 – 127	01	
	29	1	01 – 7F	AD Part Motion Seq Lane 3 Velocity Limit High	1 – 127	7F	
	2A	1		reserved			
	2B	1		reserved			
	2C	1		reserved			
	2D	1		reserved			
	2E	1		reserved			
	2F	1		reserved			
	30	1	00 – 01	AD Part Motion Seq Lane 4 Switch	Off, On	00	
	31	1	00 – 01	AD Part Motion Seq Lane 4 FX Receive	Off, On	00	
	32	1	00 – 01	AD Part Motion Seq Lane 4 Trigger Receive	Off, On	00	
	33	1	00 – 04	AD Part Motion Seq Lane 4 Sync	Off, Tempo, Beat, Arp, Lane 1	00	
	34	1	00 – 7F	AD Part Motion Seq Lane 4 Speed	0 – 127	3F	This is available only when Sync is set to Off.
	35	1	00 – 11	AD Part Motion Seq Lane 4 Unit	50%, 66%, 75%, 100%, 133%, 150%, 200%, 266%, 300%, 400%, 600%, 800%, 1200%, 1600%, 2400%, 3200%, 6400%, Common	03	This is not available when Sync is set to Off.
	36	1	00 – 02	AD Part Motion Seq Lane 4 Key On Reset	Off, Each-On, 1st-On	00	This is not available when Sync is set to Arp.
	37	1	00 – 01	AD Part Motion Seq Lane 4 Loop	Off, On	01	
	38	1	01 – 7F	AD Part Motion Seq Lane 4 Velocity Limit Low	1 – 127	01	
	39	1	01 – 7F	AD Part Motion Seq Lane 4 Velocity Limit High	1 – 127	7F	

Address	Size	Data Range (HEX)	Parameter Name	Description	Default (HEX)	Notes
	3A	1		reserved		
	3B	1		reserved		
	3C	1		reserved		
	3D	1		reserved		
	3E	1		reserved		
	3F	1		reserved		

TOTAL SIZE = 64 40 (HEX)

Address	Size	Data Range (HEX)	Parameter Name	Description	Default (HEX)	Notes
30	lm	00 1	00 - 7F	AD Part Motion Seq Amplitude	0 - 127	40
		01 1	00 - 7F	AD Part Motion Seq Smoothness	0 - 127	00
		02 1	00 - 0F	AD Part Motion Seq Cycle	1 - 16	0F
		03 1	00 - 01	AD Part Motion Seq Polarity	Uni, Bi	00
		04 1	00 - 7F	AD Part Motion Seq Step 1 Value	0 - 127	40
		05 1	00 - 7F	AD Part Motion Seq Step 2 Value	0 - 127	40
		06 1	00 - 7F	AD Part Motion Seq Step 3 Value	0 - 127	40
		07 1	00 - 7F	AD Part Motion Seq Step 4 Value	0 - 127	40
		08 1	00 - 7F	AD Part Motion Seq Step 5 Value	0 - 127	40
		09 1	00 - 7F	AD Part Motion Seq Step 6 Value	0 - 127	40
		0A 1	00 - 7F	AD Part Motion Seq Step 7 Value	0 - 127	40
		0B 1	00 - 7F	AD Part Motion Seq Step 8 Value	0 - 127	40
		0C 1	00 - 7F	AD Part Motion Seq Step 9 Value	0 - 127	40
		0D 1	00 - 7F	AD Part Motion Seq Step 10 Value	0 - 127	40
		0E 1	00 - 7F	AD Part Motion Seq Step 11 Value	0 - 127	40
		0F 1	00 - 7F	AD Part Motion Seq Step 12 Value	0 - 127	40
		10 1	00 - 7F	AD Part Motion Seq Step 13 Value	0 - 127	40
		11 1	00 - 7F	AD Part Motion Seq Step 14 Value	0 - 127	40
		12 1	00 - 7F	AD Part Motion Seq Step 15 Value	0 - 127	40
		13 1	00 - 7F	AD Part Motion Seq Step 16 Value	0 - 127	40
		14 1	00 - 01	AD Part Motion Seq Step 1 Type	A, B	00
		15 1	00 - 01	AD Part Motion Seq Step 2 Type	A, B	00
		16 1	00 - 01	AD Part Motion Seq Step 3 Type	A, B	00
		17 1	00 - 01	AD Part Motion Seq Step 4 Type	A, B	00
		18 1	00 - 01	AD Part Motion Seq Step 5 Type	A, B	00
		19 1	00 - 01	AD Part Motion Seq Step 6 Type	A, B	00
		1A 1	00 - 01	AD Part Motion Seq Step 7 Type	A, B	00
		1B 1	00 - 01	AD Part Motion Seq Step 8 Type	A, B	00
		1C 1	00 - 01	AD Part Motion Seq Step 9 Type	A, B	00
		1D 1	00 - 01	AD Part Motion Seq Step 10 Type	A, B	00
		1E 1	00 - 01	AD Part Motion Seq Step 11 Type	A, B	00
		1F 1	00 - 01	AD Part Motion Seq Step 12 Type	A, B	00
		20 1	00 - 01	AD Part Motion Seq Step 13 Type	A, B	00
		21 1	00 - 01	AD Part Motion Seq Step 14 Type	A, B	00
		22 1	00 - 01	AD Part Motion Seq Step 15 Type	A, B	00
		23 1	00 - 01	AD Part Motion Seq Step 16 Type	A, B	00
		24 1	00 - 09	AD Part Motion Seq Step Curve A Bank	0 = Preset, 1 = User, 2 = Library1, ... 9 = Library8	00
		25 1	00 - 1F	AD Part Motion Seq Step Curve A Type	0 - 31 (0 - 17 when Bank is set to Preset)	00
		26 1	00 - 7F	AD Part Motion Seq Step Curve A Parameter 1	0 - 127	05
		27 1	00 - 7F	AD Part Motion Seq Step Curve A Parameter 2	0 - 127	00
		28 1	00 - 01	AD Part Motion Seq Step Curve A Shape Control SW1	Off, On	00
		29 1	00 - 01	AD Part Motion Seq Step Curve A Shape Control SW2	Off, On	00
		2A 1	00 - 01	AD Part Motion Seq Step Curve A Direction	Forward, Reverse	00
		2B 1	00 - 09	AD Part Motion Seq Step Curve B Bank	0 = Preset, 1 = User, 2 = Library1, ... 9 = Library8	00
		2C 1	00 - 1F	AD Part Motion Seq Step Curve B Type	0 - 31 (0 - 17 when Bank is set to Preset)	00
		2D 1	00 - 7F	AD Part Motion Seq Step Curve B Parameter 1	0 - 127	05
		2E 1	00 - 7F	AD Part Motion Seq Step Curve B Parameter 2	0 - 127	00
		2F 1	00 - 01	AD Part Motion Seq Step Curve B Shape Control SW1	Off, On	00
		30 1	00 - 01	AD Part Motion Seq Step Curve B Shape Control SW2	Off, On	00
		31 1	00 - 01	AD Part Motion Seq Step Curve B Direction	Forward, Reverse	00

TOTAL SIZE = 50 32 (HEX)

l = Lane number
0 - 3

m = Motion Seq number
0 - 7

Address	Size	Data Range (HEX)	Parameter Name	Description	Default (HEX)	Notes
30	4A	00 1	00 - 01	Super Knob Motion Seq Switch	Off, On	00
		01 1	00 - 01	Super Knob Motion Seq FX Receive	Off, On	00
		02 1	00 - 01	Super Knob Motion Seq Trigger Receive	Off, On	00
		03 1	00 - 03	Super Knob Motion Seq Sync	Off, Tempo, Beat, Arp	00
		04 1	00 - 7F	Super Knob Motion Seq Speed	0 - 127	3F This is available only when Sync is set to Off.
		05 1	00 - 11	Super Knob Motion Seq Unit Multiply	50%, 66%, 75%, 100%, 133%, 150%, 200%, 266%, 300%, 400%, 600%, 800%, 1200%, 1600%, 2400%, 3200%, 6400%, Common	03 This is not available when Sync is set to Off.
		06 1	00 - 02	Super Knob Motion Seq Key On Reset	Off, Each-On, 1st-On	00 This is not available when Sync is set to Arp.
		07 1	00 - 01	Super Knob Motion Seq Loop	Off, On	01
		08 1	01 - 7F	Super Knob Motion Seq Velocity Limit Low	1 - 127	01
		09 1	01 - 7F	Super Knob Motion Seq Velocity Limit High	1 - 127	7F
		0A 1		reserved		
		0B 1		reserved		
		0C 1		reserved		
		0D 1		reserved		
		0E 1		reserved		

TOTAL SIZE = 15 0F (HEX)

Address	Size	Data Range (HEX)	Parameter Name	Description	Default (HEX)	Notes
30	6m	00 1	00 - 7F	Super Knob Motion Seq Amplitude	0 - 127	40
		01 1	00 - 7F	Super Knob Motion Seq Smoothness	0 - 127	00
		02 1	00 - 0F	Super Knob Motion Seq Cycle	1 - 16	0F
		03 1	00 - 01	Super Knob Motion Seq Polarity	00 = Unipolar, 01 = Bipolar	00
		04 1	00 - 7F	Super Knob Motion Seq Step 1 Value	0 - 127	40
		05 1	00 - 7F	Super Knob Motion Seq Step 2 Value	0 - 127	40
		06 1	00 - 7F	Super Knob Motion Seq Step 3 Value	0 - 127	40
		07 1	00 - 7F	Super Knob Motion Seq Step 4 Value	0 - 127	40
		08 1	00 - 7F	Super Knob Motion Seq Step 5 Value	0 - 127	40
		09 1	00 - 7F	Super Knob Motion Seq Step 6 Value	0 - 127	40
		0A 1	00 - 7F	Super Knob Motion Seq Step 7 Value	0 - 127	40
		0B 1	00 - 7F	Super Knob Motion Seq Step 8 Value	0 - 127	40
		0C 1	00 - 7F	Super Knob Motion Seq Step 9 Value	0 - 127	40
		0D 1	00 - 7F	Super Knob Motion Seq Step 10 Value	0 - 127	40
		0E 1	00 - 7F	Super Knob Motion Seq Step 11 Value	0 - 127	40
		0F 1	00 - 7F	Super Knob Motion Seq Step 12 Value	0 - 127	40
		10 1	00 - 7F	Super Knob Motion Seq Step 13 Value	0 - 127	40
		11 1	00 - 7F	Super Knob Motion Seq Step 14 Value	0 - 127	40
		12 1	00 - 7F	Super Knob Motion Seq Step 15 Value	0 - 127	40
		13 1	00 - 7F	Super Knob Motion Seq Step 16 Value	0 - 127	40
		14 1	00 - 01	Super Knob Motion Seq Step 1 Type	A, B	00
		15 1	00 - 01	Super Knob Motion Seq Step 2 Type	A, B	00
		16 1	00 - 01	Super Knob Motion Seq Step 3 Type	A, B	00
		17 1	00 - 01	Super Knob Motion Seq Step 4 Type	A, B	00
		18 1	00 - 01	Super Knob Motion Seq Step 5 Type	A, B	00
		19 1	00 - 01	Super Knob Motion Seq Step 6 Type	A, B	00
		1A 1	00 - 01	Super Knob Motion Seq Step 7 Type	A, B	00
		1B 1	00 - 01	Super Knob Motion Seq Step 8 Type	A, B	00

Address	Size	Data Range (HEX)	Parameter Name	Description	Default (HEX)	Notes	
	1C	1	00-01	Super Knob Motion Seq Step 9 Type	A, B	00	
	1D	1	00-01	Super Knob Motion Seq Step 10 Type	A, B	00	
	1E	1	00-01	Super Knob Motion Seq Step 11 Type	A, B	00	
	1F	1	00-01	Super Knob Motion Seq Step 12 Type	A, B	00	
	20	1	00-01	Super Knob Motion Seq Step 13 Type	A, B	00	
	21	1	00-01	Super Knob Motion Seq Step 14 Type	A, B	00	
	22	1	00-01	Super Knob Motion Seq Step 15 Type	A, B	00	
	23	1	00-01	Super Knob Motion Seq Step 16 Type	A, B	00	
	24	1	00-09	Super Knob Motion Seq Step Curve A Bank	0 = Preset, 1 = User, 2 = Library 1...9 = Library 8	00	
	25	1	00-1F	Super Knob Motion Seq Step Curve A Type	0-31 (0-17 when Bank is set to Preset)	00	
	26	1	00-7F	Super Knob Motion Seq Step Curve A Parameter 1	0-127	05	
	27	1	00-7F	Super Knob Motion Seq Step Curve A Parameter 2	0-127	00	
	28	1	00-01	Super Knob Motion Seq Step Curve A Shape Control SW1	Off, On	00	
	29	1	00-01	Super Knob Motion Seq Step Curve A Shape Control SW2	Off, On	00	
	2A	1	00-01	Super Knob Motion Seq Step Curve A Direction	Forward, Reverse	00	
	2B	1	00-09	Super Knob Motion Seq Step Curve B Bank	0 = Preset, 1 = User, 2 = Library 1...9 = Library 8	00	
	2C	1	00-1F	Super Knob Motion Seq Step Curve B Type	0-31 (0-17 when Bank is set to Preset)	00	
	2D	1	00-7F	Super Knob Motion Seq Step Curve B Parameter 1	0-127	05	
	2E	1	00-7F	Super Knob Motion Seq Step Curve B Parameter 2	0-127	00	
	2F	1	00-01	Super Knob Motion Seq Step Curve B Shape Control SW1	Off, On	00	
	30	1	00-01	Super Knob Motion Seq Step Curve B Shape Control SW2	Off, On	00	
	31	1	00-01	Super Knob Motion Seq Step Curve B Direction	Forward, Reverse	00	

TOTAL SIZE = 50 32 (HEX)

m = Motion Seq number
0-7

Address	Size	Data Range (HEX)	Parameter Name	Description	Default (HEX)	Notes		
30	4B	00	1	00-7F	Super Knob Value	0-127	40	
		01	1	00-7F	Assignable Knob 1 Destination Value 1	0-127	00	
		02	1	00-7F	Assignable Knob 1 Destination Value 2	0-127	7F	
		03	1	00-7F	Assignable Knob 2 Destination Value 1	0-127	00	
		04	1	00-7F	Assignable Knob 2 Destination Value 2	0-127	7F	
		05	1	00-7F	Assignable Knob 3 Destination Value 1	0-127	00	
		06	1	00-7F	Assignable Knob 3 Destination Value 2	0-127	7F	
		07	1	00-7F	Assignable Knob 4 Destination Value 1	0-127	00	
		08	1	00-7F	Assignable Knob 4 Destination Value 2	0-127	7F	
		09	1	00-7F	Assignable Knob 5 Destination Value 1	0-127	00	
		0A	1	00-7F	Assignable Knob 5 Destination Value 2	0-127	7F	
		0B	1	00-7F	Assignable Knob 6 Destination Value 1	0-127	00	
		0C	1	00-7F	Assignable Knob 6 Destination Value 2	0-127	7F	
		0D	1	00-7F	Assignable Knob 7 Destination Value 1	0-127	00	
		0E	1	00-7F	Assignable Knob 7 Destination Value 2	0-127	7F	
		0F	1	00-7F	Assignable Knob 8 Destination Value 1	0-127	00	
		10	1	00-7F	Assignable Knob 8 Destination Value 2	0-127	7F	
		11	1	00-11	Super Knob LED Pattern	Type 1, Type 2-1, Type 2-2, Type 3-1, Type 3-2, Type 4-1, Type 4-2, Type 5-1, Type 5-2, Type 6, Type 7-1, Type 7-2, Type 8-1, Type 8-2, Type 9, Type 10, Type 11, Off	00	
		12	1	00-0F	Super Knob / Common Motion Seq Sync Part	Part 1 - Part 16	00	

Address	Size	Data Range (HEX)	Parameter Name	Description	Default (HEX)	Notes		
		13	1	00-01	Assignable Knob 1 Independent Switch	Off, On	00	
		14	1	00-01	Assignable Knob 2 Independent Switch	Off, On	00	
		15	1	00-01	Assignable Knob 3 Independent Switch	Off, On	00	
		16	1	00-01	Assignable Knob 4 Independent Switch	Off, On	00	
		17	1	00-01	Assignable Knob 5 Independent Switch	Off, On	00	
		18	1	00-01	Assignable Knob 6 Independent Switch	Off, On	00	
		19	1	00-01	Assignable Knob 7 Independent Switch	Off, On	00	
		1A	1	00-01	Assignable Knob 8 Independent Switch	Off, On	00	
		1B	1	00-7F	Super Knob Motion Seq Random	0-127	00	

TOTAL SIZE = 28 1C (HEX)

Address	Size	Data Range (HEX)	Parameter Name	Description	Default (HEX)	Notes		
30	4C	00	1	00-07	Scene Select	1-8	00	
		01	1	00-07	Scene 1 Arpeggio Select	1-8	00	
		02	1	00-07	Scene 1 Motion Seq Select	1-8	00	
		03	1	00-01	Scene 1 Arpeggio Master Switch	Off, On	00	
		04	1	00-01	Scene 1 Motion Seq Master Switch	Off, On	00	
		05	1	00-01	Scene 1 Arpeggio Memorize Switch	Off, On	00	
		06	1	00-01	Scene 1 Motion Seq Memorize Switch	Off, On	00	
		07	1	00-01	Scene 1 Super Knob Memorize Switch	Off, On	00	
		08	1	00-01	Scene 1 Mixing Memorize Switch	Off, On	00	
		09	1	00-01	Scene 1 AEG Memorize Switch	Off, On	00	
		0A	1	00-01	Scene 1 Arp/MS FX Memorize Switch	Off, On	00	
		0B	1	00-7F	Scene 1 Super Knob Value	0-127	40	
		0C	1		reserved			
		0D	1		reserved			
		0E	1		reserved			
		0F	1		reserved			
		10	1		reserved			
		11	1	00-07	Scene 2 Arpeggio Select	1-8	00	
		12	1	00-07	Scene 2 Motion Seq Select	1-8	00	
		13	1	00-01	Scene 2 Arpeggio Master Switch	Off, On	00	
		14	1	00-01	Scene 2 Motion Seq Master Switch	Off, On	00	
		15	1	00-01	Scene 2 Arpeggio Memorize Switch	Off, On	00	
		16	1	00-01	Scene 2 Motion Seq Memorize Switch	Off, On	00	
		17	1	00-01	Scene 2 Super Knob Memorize Switch	Off, On	00	
		18	1	00-01	Scene 2 Mixing Memorize Switch	Off, On	00	
		19	1	00-01	Scene 2 AEG Memorize Switch	Off, On	00	
		1A	1	00-01	Scene 2 Arp/MS FX Memorize Switch	Off, On	00	
		1B	1	00-7F	Scene 2 Super Knob Value	0-127	40	
		1C	1		reserved			
		1D	1		reserved			
		1E	1		reserved			
		1F	1		reserved			
		20	1		reserved			
		21	1	00-07	Scene 3 Arpeggio Select	1-8	00	
		22	1	00-07	Scene 3 Motion Seq Select	1-8	00	
		23	1	00-01	Scene 3 Arpeggio Master Switch	Off, On	00	
		24	1	00-01	Scene 3 Motion Seq Master Switch	Off, On	00	
		25	1	00-01	Scene 3 Arpeggio Memorize Switch	Off, On	00	
		26	1	00-01	Scene 3 Motion Seq Memorize Switch	Off, On	00	
		27	1	00-01	Scene 3 Super Knob Memorize Switch	Off, On	00	
		28	1	00-01	Scene 3 Mixing Memorize Switch	Off, On	00	
		29	1	00-01	Scene 3 AEG Memorize Switch	Off, On	00	
		2A	1	00-01	Scene 3 Arp/MS FX Memorize Switch	Off, On	00	
		2B	1	00-7F	Scene 3 Super Knob Value	0-127	40	
		2C	1		reserved			
		2D	1		reserved			
		2E	1		reserved			
		2F	1		reserved			
		30	1		reserved			
		31	1	00-07	Scene 4 Arpeggio Select	1-8	00	
		32	1	00-07	Scene 4 Motion Seq Select	1-8	00	
		33	1	00-01	Scene 4 Arpeggio Master Switch	Off, On	00	
		34	1	00-01	Scene 4 Motion Seq Master Switch	Off, On	00	
		35	1	00-01	Scene 4 Arpeggio Memorize Switch	Off, On	00	
		36	1	00-01	Scene 4 Motion Seq Memorize Switch	Off, On	00	
		37	1	00-01	Scene 4 Super Knob Memorize Switch	Off, On	00	
		38	1	00-01	Scene 4 Mixing Memorize Switch	Off, On	00	
		39	1	00-01	Scene 4 AEG Memorize Switch	Off, On	00	
		3A	1	00-01	Scene 4 Arp/MS FX Memorize Switch	Off, On	00	
		3B	1	00-7F	Scene 4 Super Knob Value	0-127	40	

Address	Size	Data Range (HEX)	Parameter Name	Description	Default (HEX)	Notes
	3C	1		reserved		
	3D	1		reserved		
	3E	1		reserved		
	3F	1		reserved		
	40	1		reserved		
	41	1	00-07	Scene 5 Arpeggio Select	1-8	00
	42	1	00-07	Scene 5 Motion Seq Select	1-8	00
	43	1	00-01	Scene 5 Arpeggio Master Switch	Off, On	00
	44	1	00-01	Scene 5 Motion Seq Master Switch	Off, On	00
	45	1	00-01	Scene 5 Arpeggio Memorize Switch	Off, On	00
	46	1	00-01	Scene 5 Motion Seq Memorize Switch	Off, On	00
	47	1	00-01	Scene 5 Super Knob Memorize Switch	Off, On	00
	48	1	00-01	Scene 5 Mixing Memorize Switch	Off, On	00
	49	1	00-01	Scene 5 AEG Memorize Switch	Off, On	00
	4A	1	00-01	Scene 5 Arp/MS FX Memorize Switch	Off, On	00
	4B	1	00-7F	Scene 5 Super Knob Value	0-127	40
	4C	1		reserved		
	4D	1		reserved		
	4E	1		reserved		
	4F	1		reserved		
	50	1		reserved		
	51	1	00-07	Scene 6 Arpeggio Select	1-8	00
	52	1	00-07	Scene 6 Motion Seq Select	1-8	00
	53	1	00-01	Scene 6 Arpeggio Master Switch	Off, On	00
	54	1	00-01	Scene 6 Motion Seq Master Switch	Off, On	00
	55	1	00-01	Scene 6 Arpeggio Memorize Switch	Off, On	00
	56	1	00-01	Scene 6 Motion Seq Memorize Switch	Off, On	00
	57	1	00-01	Scene 6 Super Knob Memorize Switch	Off, On	00
	58	1	00-01	Scene 6 Mixing Memorize Switch	Off, On	00
	59	1	00-01	Scene 6 AEG Memorize Switch	Off, On	00
	5A	1	00-01	Scene 6 Arp/MS FX Memorize Switch	Off, On	00
	5B	1	00-7F	Scene 6 Super Knob Value	0-127	40
	5C	1		reserved		
	5D	1		reserved		
	5E	1		reserved		
	5F	1		reserved		
	60	1		reserved		
	61	1	00-07	Scene 7 Arpeggio Select	1-8	00
	62	1	00-07	Scene 7 Motion Seq Select	1-8	00
	63	1	00-01	Scene 7 Arpeggio Master Switch	Off, On	00
	64	1	00-01	Scene 7 Motion Seq Master Switch	Off, On	00
	65	1	00-01	Scene 7 Arpeggio Memorize Switch	Off, On	00
	66	1	00-01	Scene 7 Motion Seq Memorize Switch	Off, On	00
	67	1	00-01	Scene 7 Super Knob Memorize Switch	Off, On	00
	68	1	00-01	Scene 7 Mixing Memorize Switch	Off, On	00
	69	1	00-01	Scene 7 AEG Memorize Switch	Off, On	00
	6A	1	00-01	Scene 7 Arp/MS FX Memorize Switch	Off, On	00
	6B	1	00-7F	Scene 7 Super Knob Value	0-127	40
	6C	1		reserved		
	6D	1		reserved		
	6E	1		reserved		
	6F	1		reserved		
	70	1		reserved		
	71	1	00-07	Scene 8 Arpeggio Select	1-8	00
	72	1	00-07	Scene 8 Motion Seq Select	1-8	00
	73	1	00-01	Scene 8 Arpeggio Master Switch	Off, On	00
	74	1	00-01	Scene 8 Motion Seq Master Switch	Off, On	00
	75	1	00-01	Scene 8 Arpeggio Memorize Switch	Off, On	00
	76	1	00-01	Scene 8 Motion Seq Memorize Switch	Off, On	00
	77	1	00-01	Scene 8 Super Knob Memorize Switch	Off, On	00
	78	1	00-01	Scene 8 Mixing Memorize Switch	Off, On	00
	79	1	00-01	Scene 8 AEG Memorize Switch	Off, On	00
	7A	1	00-01	Scene 8 Arp/MS FX Memorize Switch	Off, On	00
	7B	1	00-7F	Scene 8 Super Knob Value	0-127	40
	7C	1		reserved		
	7D	1		reserved		
	7E	1		reserved		
	7F	1		reserved		

TOTAL SIZE = 128 80 (HEX)

Address	Size	Data Range (HEX)	Parameter Name	Description	Default (HEX)	Notes	
30	4D	00	2	00-03 00-7F	Audition Phrase Number	1-850	00 01
		02	1	28-58	Audition Note Shift	-24-24	40
		03	1	00-7F	Audition Velocity Shift	-64-63	40

TOTAL SIZE = 4 04 (HEX)

Address	Size	Data Range (HEX)	Parameter Name	Description	Default (HEX)	Notes	
30	4E	00	1	00-03	A/D Part Input Mode	L Mono, R Mono, L+R Mono, Stereo	03
		01	1	00-7F	A/D Part Volume	0-127	64
		02	1	01-7F	A/D Part Pan	L63-C-R63	40
		03	1	00-7F	A/D Part Reverb Send	0-127	00
		04	1	00-7F	A/D Part Variation Send	0-127	00
		05	1	01-02	A/D Part Insertion Connect Type	Ins A->B, Ins B->A	01
		06	1	00-03	A/D Part Insertion FX Switch	bit 0: Insertion A Off/On bit 1: Insertion B Off/On bit 2-6: reserved	03
		07	1	00-7F	A/D Part Dry Level	0-127	7F
		08	1	10-70	A/D Part Envelope Follower Gain	-24dB-0dB +24dB	40
		09	1	00-13	A/D Part Envelope Follower Attack	1ms-40ms	10
		0A	1	00-0F	A/D Part Envelope Follower Release	10ms-680ms	07
		0B	1	00-05	A/D Part 2-band EQ 1 Type	Thru, LPF, HPF, Low Shelf, Hi Shelf, Peak/Dip	00
		0C	2	00-01 00-7F	A/D Part 2-band EQ 1 Frequency	1st bit6-0 → bit13-7 2nd bit6-0 → bit6-0 63.0-18.0k	00 30
		0E	1	28-58	A/D Part 2-band EQ 1 Gain	-12.0dB +12.0dB	40
		0F	1	01-78	A/D Part 2-band EQ 1 Q	0.1-12.0	01
		10	1	00-05	A/D Part 2-band EQ 2 Type	Thru, LPF, HPF, Low Shelf Hi Shelf, Peak/Dip	00
		11	2	00-01 00-7F	A/D Part 2-band EQ 2 Frequency	1st bit6-0 → bit13-7 2nd bit6-0 → bit6-0 63.0-18.0k	00 30
		13	1	28-58	A/D Part 2-band EQ 2 Gain	-12.0dB +12.0dB	40
		14	1	01-78	A/D Part 2-band EQ 2 Q	0.1-12.0	01
		15	1	28-58	A/D Part 2-band EQ Output Gain	-12.0dB +12.0dB	40
		16	1	00-5F, 7D	A/D Part Output Select	0: MainL&R, 8: AsgnL&R, 9-23: USB1&2...USB29&30, 64-95: AsgnL, AsgnR, USB1...USB30, 125: Off	00
		17	1	00-01	A/D Part Motion Seq Part Switch	Off, On	01
		18	1		reserved		
		19	1		reserved		
		1A	1		reserved		
		1B	1	00-7F	A/D Part Motion Seq Random	0-127	00

TOTAL SIZE = 28 1C (HEX)

Address	Size	Data Range (HEX)	Parameter Name	Description	Default (HEX)	Notes	
30	4F	00	1	00-03	Digital Part Input Mode	L Mono, R Mono, L+R Mono, Stereo	03
		01	1	00-7F	Digital Part Volume	0-127	64
		02	1	01-7F	Digital Part Pan	L63-C-R63	40
		03	1	00-7F	Digital Part Reverb Send	0-127	00
		04	1	00-7F	Digital Part Variation Send	0-127	00
		05	1		reserved		
		06	1		reserved		
		07	1	00-7F	Digital Part Dry Level	0-127	7F
		08	1		reserved		
		09	1		reserved		
		0A	1		reserved		
		0B	1		reserved		
		0C	2		reserved		
		0E	1		reserved		
		0F	1		reserved		
		10	1		reserved		
		11	2		reserved		
		13	1		reserved		
		14	1		reserved		
		15	1		reserved		
		16	1	00-5F, 7D	Digital Part Output Select	0: MainL&R, 8: AsgnL&R, 9-23: USB1&2...USB29&30, 64-95: AsgnL, AsgnR, USB1...USB30, 125: Off	00

TOTAL SIZE = 23 17 (HEX)

Address	Size	Data Range (HEX)	Parameter Name	Description	Default (HEX)	Notes	
	OD	1	00 - 1F	Controller Set 2 Curve Type	0 - 31 (0 - 17 when Bank is set to Preset)	00	
	0E	1	00 - 7F	Controller Set 2 Curve Parameter 1	0 - 127	05	Fixed to "0" except when Bank is set to Preset.
	0F	1	00 - 7F	Controller Set 2 Curve Parameter 2	0 - 127	00	Fixed to "0" except when Bank is set to Preset.
	10	1	00 - 01	Controller Set 2 Curve Polarity	Uni, Bi	00	
	11	1	00 - 7F	Controller Set 2 Curve Ratio	-64 - +63	60	
	12	1	08 - 0F, 12 - 27	Controller Set 3 Source	8 - 15, 18 - 39 (Refer to Controller Box Source of Control List)	08	
	13	2	00 - 00, 00 - 7F	Controller Set 3 Destination	1st bit6-0 → bit13-7 2nd bit6-0 → bit6-0 0 - 251 (Refer to Controller Box Destination of Control List)	00 00	
	15	1	00 - 09	Controller Set 3 Curve Bank	0 = Preset, 1 = User, 2 = Library1, ... 9 = Library8	00	
	16	1	00 - 1F	Controller Set 3 Curve Type	0 - 31 (0 - 17 when Bank is set to Preset)	00	
	17	1	00 - 7F	Controller Set 3 Curve Parameter 1	0 - 127	05	Fixed to "0" except when Bank is set to Preset.
	18	1	00 - 7F	Controller Set 3 Curve Parameter 2	0 - 127	00	Fixed to "0" except when Bank is set to Preset.
	19	1	00 - 01	Controller Set 3 Curve Polarity	Uni, Bi	00	
	1A	1	00 - 7F	Controller Set 3 Curve Ratio	-64 - +63	60	
	1B	1	08 - 0F, 12 - 27	Controller Set 4 Source	8 - 15, 18 - 39 (Refer to Controller Box Source of Control List)	08	
	1C	2	00 - 00, 00 - 7F	Controller Set 4 Destination	1st bit6-0 → bit13-7 2nd bit6-0 → bit6-0 0 - 251 (Refer to Controller Box Destination of Control List)	00 00	
	1E	1	00 - 09	Controller Set 4 Curve Bank	0 = Preset, 1 = User, 2 = Library1, ... 9 = Library8	00	
	1F	1	00 - 1F	Controller Set 4 Curve Type	0 - 31 (0 - 17 when Bank is set to Preset)	00	
	20	1	00 - 7F	Controller Set 4 Curve Parameter 1	0 - 127	05	Fixed to "0" except when Bank is set to Preset.
	21	1	00 - 7F	Controller Set 4 Curve Parameter 2	0 - 127	00	Fixed to "0" except when Bank is set to Preset.
	22	1	00 - 01	Controller Set 4 Curve Polarity	Uni, Bi	00	
	23	1	00 - 7F	Controller Set 4 Curve Ratio	-64 - +63	60	
	24	1	08 - 0F, 12 - 27	Controller Set 5 Source	8 - 15, 18 - 39 (Refer to Controller Box Source of Control List)	08	
	25	2	00 - 00, 00 - 7F	Controller Set 5 Destination	1st bit6-0 → bit13-7 2nd bit6-0 → bit6-0 0 - 251 (Refer to Controller Box Destination of Control List)	00 00	
	27	1	00 - 09	Controller Set 5 Curve Bank	0 = Preset, 1 = User, 2 = Library1...9 = Library8	00	
	28	1	00 - 1F	Controller Set 5 Curve Type	0 - 31 (0 - 17 when Bank is set to Preset)	00	
	29	1	00 - 7F	Controller Set 5 Curve Parameter 1	0 - 127	05	Fixed to "0" except when Bank is set to Preset.
	2A	1	00 - 7F	Controller Set 5 Curve Parameter 2	0 - 127	00	Fixed to "0" except when Bank is set to Preset.
	2B	1	00 - 01	Controller Set 5 Curve Polarity	Uni, Bi	00	
	2C	1	00 - 7F	Controller Set 5 Curve Ratio	-64 - +63	60	
	2D	1	08 - 0F, 12 - 27	Controller Set 6 Source	8 - 15, 18 - 39 (Refer to Controller Box Source of Control List)	08	
	2E	2	00 - 00, 00 - 7F	Controller Set 6 Destination	1st bit6-0 → bit13-7 2nd bit6-0 → bit6-0 0 - 251 (Refer to Controller Box Destination of Control List)	00 00	
	30	1	00 - 09	Controller Set 6 Curve Bank	0 = Preset, 1 = User, 2 = Library1...9 = Library8	00	
	31	1	00 - 1F	Controller Set 6 Curve Type	0 - 31 (0 - 17 when Bank is set to Preset)	00	

Address	Size	Data Range (HEX)	Parameter Name	Description	Default (HEX)	Notes	
	32	1	00 - 7F	Controller Set 6 Curve Parameter 1	0 - 127	05	Fixed to "0" except when Bank is set to Preset.
	33	1	00 - 7F	Controller Set 6 Curve Parameter 2	0 - 127	00	Fixed to "0" except when Bank is set to Preset.
	34	1	00 - 01	Controller Set 6 Curve Polarity	Uni, Bi	00	
	35	1	00 - 7F	Controller Set 6 Curve Ratio	-64 - +63	60	
	36	1	08 - 0F, 12 - 27	Controller Set 7 Source	8 - 15, 18 - 39 (Refer to Controller Box Source of Control List)	08	
	37	2	00 - 00, 00 - 7F	Controller Set 7 Destination	1st bit6-0 → bit13-7 2nd bit6-0 → bit6-0 0 - 251 (Refer to Controller Box Destination of Control List)	00 00	
	39	1	00 - 09	Controller Set 7 Curve Bank	0 = Preset, 1 = User, 2 = Library1...9 = Library8	00	
	3A	1	00 - 1F	Controller Set 7 Curve Type	0 - 31 (0 - 17 when Bank is set to Preset)	00	
	3B	1	00 - 7F	Controller Set 7 Curve Parameter 1	0 - 127	05	Fixed to "0" except when Bank is set to Preset.
	3C	1	00 - 7F	Controller Set 7 Curve Parameter 2	0 - 127	00	Fixed to "0" except when Bank is set to Preset.
	3D	1	00 - 01	Controller Set 7 Curve Polarity	Uni, Bi	00	
	3E	1	00 - 7F	Controller Set 7 Curve Ratio	-64 - +63	60	
	3F	1	08 - 0F, 12 - 27	Controller Set 8 Source	8 - 15, 18 - 39 (Refer to Controller Box Source of Control List)	08	
	40	2	00 - 00, 00 - 7F	Controller Set 8 Destination	1st bit6-0 → bit13-7 2nd bit6-0 → bit6-0 0 - 251 (Refer to Controller Box Destination of Control List)	00 00	
	42	1	00 - 09	Controller Set 8 Curve Bank	0 = Preset, 1 = User, 2 = Library1, ... 9 = Library8	00	
	43	1	00 - 1F	Controller Set 8 Curve Type	0 - 31 (0 - 17 when Bank is set to Preset)	00	
	44	1	00 - 7F	Controller Set 8 Curve Parameter 1	0 - 127	05	Fixed to "0" except when Bank is set to Preset.
	45	1	00 - 7F	Controller Set 8 Curve Parameter 2	0 - 127	00	Fixed to "0" except when Bank is set to Preset.
	46	1	00 - 01	Controller Set 8 Curve Polarity	Uni, Bi	00	
	47	1	00 - 7F	Controller Set 8 Curve Ratio	-64 - +63	60	
	48	1	08 - 0F, 12 - 27	Controller Set 9 Source	8 - 15, 18 - 39 (Refer to Controller Box Source of Control List)	08	
	49	2	00 - 00, 00 - 7F	Controller Set 9 Destination	1st bit6-0 → bit13-7 2nd bit6-0 → bit6-0 0 - 251 (Refer to Controller Box Destination of Control List)	00 00	
	4B	1	00 - 09	Controller Set 9 Curve Bank	0 = Preset, 1 = User, 2 = Library1, ... 9 = Library8	00	
	4C	1	00 - 1F	Controller Set 9 Curve Type	0 - 31 (0 - 17 when Bank is set to Preset)	00	
	4D	1	00 - 7F	Controller Set 9 Curve Parameter 1	0 - 127	05	Fixed to "0" except when Bank is set to Preset.
	4E	1	00 - 7F	Controller Set 9 Curve Parameter 2	0 - 127	00	Fixed to "0" except when Bank is set to Preset.
	4F	1	00 - 01	Controller Set 9 Curve Polarity	Uni, Bi	00	
	50	1	00 - 7F	Controller Set 9 Curve Ratio	-64 - +63	60	
	51	1	08 - 0F, 12 - 27	Controller Set 10 Source	8 - 15, 18 - 39 (Refer to Controller Box Source of Control List)	08	
	52	2	00 - 00, 00 - 7F	Controller Set 10 Destination	1st bit6-0 → bit13-7 2nd bit6-0 → bit6-0 0 - 251 (Refer to Controller Box Destination of Control List)	00 00	
	54	1	00 - 09	Controller Set 10 Curve Bank	0 = Preset, 1 = User, 2 = Library1...9 = Library8	00	
	55	1	00 - 1F	Controller Set 10 Curve Type	0 - 31 (0 - 17 when Bank is set to Preset)	00	
	56	1	00 - 7F	Controller Set 10 Curve Parameter 1	0 - 127	05	Fixed to "0" except when Bank is set to Preset.

Address	Size	Data Range (HEX)	Parameter Name	Description	Default (HEX)	Notes
57	1	00 - 7F	Controller Set 10 Curve Parameter 2	0 - 127	00	Fixed to "0" except when Bank is set to Preset.
58	1	00 - 01	Controller Set 10 Curve Polarity	Uni, Bi	00	
59	1	00 - 7F	Controller Set 10 Curve Ratio	-64 - +63	60	
5A	1	08 - 0F, 12 - 27	Controller Set 11 Source	8 - 15, 18 - 39 (Refer to Controller Box Source of Control List)	08	
5B	2	00 - 00 00 - 7F	Controller Set 11 Destination	1st bit6-0 → bit13-7 2nd bit6-0 → bit6-0 0 - 251 (Refer to Controller Box Destination of Control List)	00 00	
5D	1	00 - 09	Controller Set 11 Curve Bank	0 = Preset, 1 = User, 2 = Library1...9 = Library8	00	
5E	1	00 - 1F	Controller Set 11 Curve Type	0 - 31 (0 - 17 when Bank is set to Preset)	00	
5F	1	00 - 7F	Controller Set 11 Curve Parameter 1	0 - 127	05	Fixed to "0" except when Bank is set to Preset.
60	1	00 - 7F	Controller Set 11 Curve Parameter 2	0 - 127	00	Fixed to "0" except when Bank is set to Preset.
61	1	00 - 01	Controller Set 11 Curve Polarity	Uni, Bi	00	
62	1	00 - 7F	Controller Set 11 Curve Ratio	-64 - +63	60	
63	1	08 - 0F, 12 - 27	Controller Set 12 Source	8 - 15, 18 - 39 (Refer to Controller Box Source of Control List)	08	
64	2	00 - 00 00 - 7F	Controller Set 12 Destination	1st bit6-0 → bit13-7 2nd bit6-0 → bit6-0 0 - 251 (Refer to Controller Box Destination of Control List)	00 00	
66	1	00 - 09	Controller Set 12 Curve Bank	0 = Preset, 1 = User, 2 = Library1...9 = Library8	00	
67	1	00 - 1F	Controller Set 12 Curve Type	0 - 31 (0 - 17 when Bank is set to Preset)	00	
68	1	00 - 7F	Controller Set 12 Curve Parameter 1	0 - 127	05	Fixed to "0" except when Bank is set to Preset.
69	1	00 - 7F	Controller Set 12 Curve Parameter 2	0 - 127	00	Fixed to "0" except when Bank is set to Preset.
6A	1	00 - 01	Controller Set 12 Curve Polarity	Uni, Bi	00	
6B	1	00 - 7F	Controller Set 12 Curve Ratio	-64 - +63	60	
6C	1	08 - 0F, 12 - 27	Controller Set 13 Source	8 - 15, 18 - 39 (Refer to Controller Box Source of Control List)	08	
6D	2	00 - 00 00 - 7F	Controller Set 13 Destination	1st bit6-0 → bit13-7 2nd bit6-0 → bit6-0 0 - 251 (Refer to Controller Box Destination of Control List)	00 00	
6F	1	00 - 09	Controller Set 13 Curve Bank	0 = Preset, 1 = User, 2 = Library1...9 = Library8	00	
70	1	00 - 1F	Controller Set 13 Curve Type	0 - 31 (0 - 17 when Bank is set to Preset)	00	
71	1	00 - 7F	Controller Set 13 Curve Parameter 1	0 - 127	05	Fixed to "0" except when Bank is set to Preset.
72	1	00 - 7F	Controller Set 13 Curve Parameter 2	0 - 127	00	Fixed to "0" except when Bank is set to Preset.
73	1	00 - 01	Controller Set 13 Curve Polarity	Uni, Bi	00	
74	1	00 - 7F	Controller Set 13 Curve Ratio	-64 - +63	60	

TOTAL SIZE = 117 75 (HEX)

Address	Size	Data Range (HEX)	Parameter Name	Description	Default (HEX)	Notes		
30	52	00	1	08 - 0F, 12 - 27	Controller Set 14 Source	8 - 15, 18 - 39 (Refer to Controller Box Source of Control List)	08	
		01	2	00 - 00 00 - 7F	Controller Set 14 Destination	1st bit6-0 → bit13-7 2nd bit6-0 → bit6-0 0 - 251 (Refer to Controller Box Destination of Control List)	00 00	
		03	1	00 - 09	Controller Set 14 Curve Bank	0 = Preset, 1 = User, 2 = Library1...9 = Library8	00	
		04	1	00 - 1F	Controller Set 14 Curve Type	0 - 31 (0 - 17 when Bank is set to Preset)	00	
		05	1	00 - 7F	Controller Set 14 Curve Parameter 1	0 - 127	05	Fixed to "0" except when Bank is set to Preset.
		06	1	00 - 7F	Controller Set 14 Curve Parameter 2	0 - 127	00	Fixed to "0" except when Bank is set to Preset.
		07	1	00 - 01	Controller Set 14 Curve Polarity	Uni, Bi	00	
		08	1	00 - 7F	Controller Set 14 Curve Ratio	-64 - +63	60	
		09	1	08 - 0F, 12 - 27	Controller Set 15 Source	8 - 15, 18 - 39 (Refer to Controller Box Source of Control List)	08	
		0A	2	00 - 00 00 - 7F	Controller Set 15 Destination	1st bit6-0 → bit13-7 2nd bit6-0 → bit6-0 0 - 251 (Refer to Controller Box Destination of Control List)	00 00	
		0C	1	00 - 09	Controller Set 15 Curve Bank	0 = Preset, 1 = User, 2 = Library1...9 = Library8	00	
		0D	1	00 - 1F	Controller Set 15 Curve Type	0 - 31 (0 - 17 when Bank is set to Preset)	00	
		0E	1	00 - 7F	Controller Set 15 Curve Parameter 1	0 - 127	05	Fixed to "0" except when Bank is set to Preset.
		0F	1	00 - 7F	Controller Set 15 Curve Parameter 2	0 - 127	00	Fixed to "0" except when Bank is set to Preset.
		10	1	00 - 01	Controller Set 15 Curve Polarity	Uni, Bi	00	
		11	1	00 - 7F	Controller Set 15 Curve Ratio	-64 - +63	60	
		12	1	08 - 0F, 12 - 27	Controller Set 16 Source	8 - 15, 18 - 39 (Refer to Controller Box Source of Control List)	08	
		13	2	00 - 00 00 - 7F	Controller Set 16 Destination	1st bit6-0 → bit13-7 2nd bit6-0 → bit6-0 0 - 251 (Refer to Controller Box Destination of Control List)	00 00	
		15	1	00 - 09	Controller Set 16 Curve Bank	0 = Preset, 1 = User, 2 = Library1...9 = Library8	00	
		16	1	00 - 1F	Controller Set 16 Curve Type	0 - 31 (0 - 17 when Bank is set to Preset)	00	
		17	1	00 - 7F	Controller Set 16 Curve Parameter 1	0 - 127	05	Fixed to "0" except when Bank is set to Preset.
		18	1	00 - 7F	Controller Set 16 Curve Parameter 2	0 - 127	00	Fixed to "0" except when Bank is set to Preset.
		19	1	00 - 01	Controller Set 16 Curve Polarity	Uni, Bi	00	
		1A	1	00 - 7F	Controller Set 16 Curve Ratio	-64 - +63	60	

TOTAL SIZE = 27 1B (HEX)

MIDI PARAMETER CHANGE TABLE (PERFORMANCE PART)

Address	Size	Data Range (HEX)	Parameter Name	Description	Default (HEX)	Notes		
31	Op	00	1	00, 20-7E	Part Name 1	0, 32 - 126 (ASCII)	Initialized Perform	
		01	1	00, 20-7E	Part Name 2	0, 32 - 126 (ASCII)		
		02	1	00, 20-7E	Part Name 3	0, 32 - 126 (ASCII)		
		03	1	00, 20-7E	Part Name 4	0, 32 - 126 (ASCII)		
		04	1	00, 20-7E	Part Name 5	0, 32 - 126 (ASCII)		
		05	1	00, 20-7E	Part Name 6	0, 32 - 126 (ASCII)		
		06	1	00, 20-7E	Part Name 7	0, 32 - 126 (ASCII)		
		07	1	00, 20-7E	Part Name 8	0, 32 - 126 (ASCII)		
		08	1	00, 20-7E	Part Name 9	0, 32 - 126 (ASCII)		
		09	1	00, 20-7E	Part Name 10	0, 32 - 126 (ASCII)		
		0A	1	00, 20-7E	Part Name 11	0, 32 - 126 (ASCII)		
		0B	1	00, 20-7E	Part Name 12	0, 32 - 126 (ASCII)		
		0C	1	00, 20-7E	Part Name 13	0, 32 - 126 (ASCII)		
		0D	1	00, 20-7E	Part Name 14	0, 32 - 126 (ASCII)		
		0E	1	00, 20-7E	Part Name 15	0, 32 - 126 (ASCII)		
		0F	1	00, 20-7E	Part Name 16	0, 32 - 126 (ASCII)		
		10	1	00, 20-7E	Part Name 17	0, 32 - 126 (ASCII)		
		11	1	00, 20-7E	Part Name 18	0, 32 - 126 (ASCII)		
		12	1	00, 20-7E	Part Name 19	0, 32 - 126 (ASCII)		
		13	1	00, 20-7E	Part Name 20	0, 32 - 126 (ASCII)		
		14	1	00-10	Part Main Category	0 - 16 Refer to Performance Category List	10 (NoAsg)	Refer to Performance Category List.
		15	1	00-07	Part Sub Category	0 - 7 Refer to Performance Category List	00 (-)	Refer to Performance Category List.
		16	1	00-01	Part Switch	Off, On	01	
		17	1	00-01	Keyboard Control Switch	Off, On	00	Fixed to "Off" for Part 9 or later.
		18	1	00-01	Mute Switch	Off, On	00	
		19	1		reserved			
		1A	1		reserved			
		1B	1		reserved			
		1C	1	01-7F	Velocity Limit Low	1 - 127	01	
		1D	1	01-7F	Velocity Limit High	1 - 127	7F	
		1E	1	00-7F	Note Limit Low	C-2 - G8	00	
		1F	1	00-7F	Note Limit High	C-2 - G8	7F	
		20	1	10-58	Pitch Bend Range Upper	-48 - +24	42	
		21	1	10-58	Pitch Bend Range Lower	-48 - +24	3E	
		22	1	00-7F	Velocity Sensitivity Depth	0 - 127	40	
		23	1	00-7F	Velocity Sensitivity Offset	0 - 127	40	
		24	1	00-7F	Volume	0 - 127	64	
		25	1	01-7F	Pan	L63 - C - R63	40	
		26	1	00-03	Insertion FX Switch	bit 0: Insertion A Off On, bit 1: Insertion B Off On, bit2-6: reserved	03	
		27	2	00-0F 00-0F	Detune	-12.8 - +12.7 [Hz] 1st bit3-0 → bit7-4 2nd bit3-0 → bit3-0	08 00 (80)	
		29	1	00-7F	Reverb Send	0 - 127	0C	
		2A	1	00-7F	Variation Send	0 - 127	00	
		2B	1		reserved			
		2C	1	00-7F	Dry Level	0 - 127	7F	
		2D	1	28-58	Note Shift	-24 - +24 [semitones]	40	Not available for Drum Part
		2E	1	10-70	Envelope Follower Gain	-24dB - 0dB - +24dB	40	
		2F	1	00-13	Envelope Follower Attack	1ms - 40ms	10	
		30	1	00-0F	Envelope Follower Release	10ms - 680ms	07	

Address	Size	Data Range (HEX)	Parameter Name	Description	Default (HEX)	Notes		
		31	1	00-01	Portamento Switch	Off, On	00	Not available for Drum Part
		32	1	00-7F	Portamento Time	0 - 127	40	Not available for Drum Part
		33	1	00-01	Portamento Mode	Fingered, Full-time	01	Not available for Drum Part
		34	1	00-03	Portamento Time Mode	Rate 1, Time 1, Rate 2, Time 2	00	Not available for Drum Part
		35	1	00-01	Key Assign Mode	Single, Multi	01	Not available for Drum Part
		36	1	00-01	Mono/Poly Mode	Mono, Poly	01	Not available for Drum Part
		37	2	00 00-54	Micro Tuning Scale	Equal Temperament, Pure Major, Pure Minor, Werckmeister, Kirnberger, Valloti&Young, 1/4 Shift, 1/4 tone, 1/8 tone, Indian, Arabic 1, Arabic 2, Arabic 3, User 1 - 8, Library 1 - 24	00 00	Not available for Drum Part
		39	1	00-0B	Micro Tuning Root	C - B	00	Not available for Drum Part
		3A	1	00-07	Legato Slope	0 - 7	00	Not available for Drum and FM Parts
		3B	1	00-02	Insertion Connection Type	Parallel, Ins A->B, Ins B->A	00	Parallel is not available for FM
		3C	1	00-7F	Insertion to Reverb Send Level	0 - 127	00	Drum Part only.
		3D	1	00-7F	Insertion to Variation Send Level	0 - 127	00	Drum Part only.
		3E	1		reserved			
		3F	1	00-7F	Part Output Select	0: MainL&R, 8: AsgnL&R, 9-23: USB1&2...USB29&30, 64-95: AsgnL, AsgnR, USB1...USB30, 125: Off, 127: Drum	00	When set to 127, "Drum" is only for Drum Part and "MainL&R" is for the other Parts
		40	1	18-7C	Receive Pitch Bend Receive After Touch Receive Program Change Receive Bank Select Receive Control Change	bit 6: Off, On PB bit 5: Off, On AT bit 4: Off, On Program Change bit 3: Off, On Bank Select bit 2: Off, On Control Change bit1-0: reserved	7C	
		41	1	00-7F	Receive Assignable Knob 8 Receive Assignable Knob 7 Receive Assignable Knob 6 Receive Assignable Knob 5 Receive Assignable Knob 4 Receive Assignable Knob 3 Receive Assignable Knob 2	bit 6: Off, On Assignable Knob 8 bit 5: Off, On Assignable Knob 7 bit 4: Off, On Assignable Knob 6 bit 3: Off, On Assignable Knob 5 bit 2: Off, On Assignable Knob 4 bit 1: Off, On Assignable Knob 3 bit 0: Off, On Assignable Knob 2	7F	
		42	1	00-7F	Receive Assignable Knob 1 Receive Foot Controller 2 Receive Foot Controller 1 Receive Modulation Wheel Receive Sustain / Sostenuto Receive Pan Receive Volume / Expression	bit 6: Off, On Assignable Knob 1 bit 5: Off, On FC2 bit 4: Off, On FC1 bit 3: Off, On MW bit 2: Off, On Sustain/ Sostenuto bit 1: Off, On Pan bit 0: Off, On Volume/ Expression	7F	
		43	1	00-70	Receive Ribbon Controller Receive Breath Controller Receive Foot Switch	bit 6: Off, On RB bit 5: Off, On BC bit 4: Off, On FS bit 3: reserved bit 2: reserved bit 1: reserved bit 0: reserved	70	

Address	Size	Data Range (HEX)	Parameter Name	Description	Default (HEX)	Notes
44	1	00 - 78	Receive Motion Seq Trigger Receive Motion Seq Hold Receive Assignable Function 2 Receive Assignable Function 1	bit 6: Off, On Motion Seq bit 5: Off, On Motion Seq bit 4: Off, On Assignable Function 2 bit 3: Off, On Assignable Function 1 bit 2: reserved bit 1: reserved bit 0: reserved	78	
45	1	00 - 01	Element Pan Switch	Off, On	01	
46	1	00 - 7F	AEG Attack Time	-64 - +63	40	
47	1	00 - 7F	AEG Decay Time	-64 - +63	40	
48	1	00 - 7F	AEG Sustain Level	-64 - +63	40	Not available for Drum Part
49	1	00 - 7F	AEG Release Time	-64 - +63	40	Not available for Drum Part
4A	1	00 - 7F	FEG Attack Time	-64 - +63	40	Not available for Drum Part
4B	1	00 - 7F	FEG Decay Time	-64 - +63	40	Not available for Drum Part
4C	1	00 - 7F	FEG Sustain Level	-64 - +63	40	Not available for Drum Part
4D	1	00 - 7F	FEG Release Time	-64 - +63	40	Not available for Drum Part
4E	1	00 - 7F	FEG Depth	-64 - +63	40	Not available for Drum Part
4F	1		reserved			
50	1	00 - 7F	Filter Cutoff Frequency	-64 - +63	40	
51	1	00 - 7F	Filter Resonance/Width	-64 - +63	40	
52	1		reserved			
53	2	00 - 01 00 - 7F	3-band EQ Low Frequency	50.1 - 2.00k 1st bit6-0 → bit13-7 2nd bit6-0 → bit6-0	00 36	
55	1	20 - 60	3-band EQ Low Gain	-12.00dB - +12.00dB	40	
56	1		reserved			
57	2	00 - 01 00 - 7F	3-band EQ Mid Frequency	139.7 - 10.1k 1st bit6-0 → bit13-7 2nd bit6-0 → bit6-0	01 0D	
59	1	20 - 60	3-band EQ Mid Gain	-12.00dB - +12.00dB	40	
5A	1	00 - 1F	3-band EQ Mid Q	0.7 - 10.3	00	
5B	2	01 03 - 7F	3-band EQ High Frequency	503.8 - 14.0k 1st bit6-0 → bit13-7 2nd bit6-0 → bit6-0	01 67	
5D	1	20 - 60	3-band EQ High Gain	-12.00dB - +12.00dB	40	
5E	1		reserved			
5F	1	00 - 05	2-band EQ 1 Type	Thru, LPF, HPF, Low Shelf, Hi Shelf, Peak/Dip	00	
60	2	00 - 01 00 - 7F	2-band EQ 1 Frequency	1st bit6-0 → bit13-7 2nd bit6-0 → bit6-0 63.0 - 18.0k	00 30	
62	1	28 - 58	2-band EQ 1 Gain	-12.0dB - +12.0dB	40	
63	1	01 - 78	2-band EQ 1 Q	0.1 - 12.0	01	
64	1	00 - 05	2-band EQ 2 Type	Thru, LPF, HPF, Low Shelf, Hi Shelf, Peak/Dip	00	
65	2	00 - 01 00 - 7F	2-band EQ 2 Frequency	1st bit6-0 → bit13-7 2nd bit6-0 → bit6-0 63.0 - 18.0k	00 30	
67	1	28 - 58	2-band EQ 2 Gain	-12.0dB - +12.0dB	40	
68	1	01 - 78	2-band EQ 2 Q	0.1 - 12.0	01	
69	1	28 - 58	2-band EQ Output Gain	-12.0dB - +12.0dB	40	
6A	1	00 - 7F	Assignable Knob 1 Value	0 - 127	40	
6B	1	00 - 7F	Assignable Knob 2 Value	0 - 127	40	
6C	1	00 - 7F	Assignable Knob 3 Value	0 - 127	40	
6D	1	00 - 7F	Assignable Knob 4 Value	0 - 127	40	
6E	1	00 - 7F	Assignable Knob 5 Value	0 - 127	40	
6F	1	00 - 7F	Assignable Knob 6 Value	0 - 127	40	
70	1	00 - 7F	Assignable Knob 7 Value	0 - 127	40	
71	1	00 - 7F	Assignable Knob 8 Value	0 - 127	40	
72	2	00 - 01 00 - 7F	Swing	-120 - 0 - +120 1st bit6-0 → bit13-7 2nd bit6-0 → bit6-0	01 00	
74	1	00 - 01	Motion Seq Part Switch	Off, On	01	
75	1	00 - 7F	Motion Seq Amplitude	-64 - +63	40	

Address	Size	Data Range (HEX)	Parameter Name	Description	Default (HEX)	Notes
76	1	0E - 72	Motion Seq Pulse Shape	-100, -98 - 0 - +98, +100	40	
77	1	00 - 7F	Motion Seq Smooth	-64 - +63	40	
78	1	00 - 7F	Motion Seq Random	0 - 127	00	

TOTAL SIZE = 121 79 (HEX)

p = Part number
0 - F

Address	Size	Data Range (HEX)	Parameter Name	Description	Default (HEX)	Notes		
31	1p	00	1	00 - 01	Lane 1 Switch	Off, On	00	
		01	1	00 - 01	Lane 1 FX Receive	Off, On	00	
		02	1	00 - 01	Lane 1 Trigger Receive	Off, On	00	
		03	1	00 - 03	Lane 1 Sync	Off, Tempo, Beat, Arp	00	
		04	1	00 - 7F	Lane 1 Speed	0 - 127	3F	This is available only when Sync is set to Off.
		05	1	00 - 12	Lane 1 Unit	50%, 66%, 75%, 100%, 133%, 150%, 200%, 266%, 300%, 400%, 600%, 800%, 1200%, 1600%, 2400%, 3200%, 6400%, Common, Arp	03	This is not available when Sync is set to Off.
		06	1	00 - 02	Lane 1 Key On Reset	Off, Each-On, 1st-On	00	This is not available when Sync is set to Arp.
		07	1	00 - 01	Lane 1 Loop	Off, On	01	
		08	1	01 - 7F	Lane 1 Velocity Limit Low	1 - 127	01	
		09	1	01 - 7F	Lane 1 Velocity Limit High	1 - 127	7F	
		0A	1		reserved			
		0B	1		reserved			
		0C	1		reserved			
		0D	1		reserved			
		0E	1		reserved			
		0F	1		reserved			
		10	1	00 - 01	Lane 2 Switch	Off, On	00	
		11	1	00 - 01	Lane 2 FX Receive	Off, On	00	
		12	1	00 - 01	Lane 2 Trigger Receive	Off, On	00	
		13	1	00 - 04	Lane 2 Sync	Off, Tempo, Beat, Arp, Lane1	00	
		14	1	00 - 7F	Lane 2 Speed	0 - 127	3F	This is available only when Sync is set to Off.
		15	1	00 - 12	Lane 2 Unit	50%, 66%, 75%, 100%, 133%, 150%, 200%, 266%, 300%, 400%, 600%, 800%, 1200%, 1600%, 2400%, 3200%, 6400%, Common, Arp	03	This is not available when Sync is set to Off.
		16	1	00 - 02	Lane 2 Key On Reset	Off, Each-On, 1st-On	00	This is not available when Sync is set to Arp.
		17	1	00 - 01	Lane 2 Loop	Off, On	01	
		18	1	01 - 7F	Lane 2 Velocity Limit Low	1 - 127	01	
		19	1	01 - 7F	Lane 2 Velocity Limit High	1 - 127	7F	
		1A	1		reserved			
		1B	1		reserved			
		1C	1		reserved			
		1D	1		reserved			
		1E	1		reserved			
		1F	1		reserved			
		20	1	00 - 01	Lane 3 Switch	Off, On	00	
		21	1	00 - 01	Lane 3 FX Receive	Off, On	00	
		22	1	00 - 01	Lane 3 Trigger Receive	Off, On	00	
		23	1	00 - 04	Lane 3 Sync	Off, Tempo, Beat, Arp, Lane1	00	
		24	1	00 - 7F	Lane 3 Speed	0 - 127	3F	This is available only when Sync is set to Off.
		25	1	00 - 12	Lane 3 Unit	50%, 66%, 75%, 100%, 133%, 150%, 200%, 266%, 300%, 400%, 600%, 800%, 1200%, 1600%, 2400%, 3200%, 6400%, Common, Arp	03	This is not available when Sync is set to Off.

Address	Size	Data Range (HEX)	Parameter Name	Description	Default (HEX)	Notes
26	1	00 - 02	Lane 3 Key On Reset	Off, Each-On, 1st-On	00	This is not available when Sync is set to Arp.
27	1	00 - 01	Lane 3 Loop	Off, On	01	
28	1	01 - 7F	Lane 3 Velocity Limit Low	1 - 127	01	
29	1	01 - 7F	Lane 3 Velocity Limit High	1 - 127	7F	
2A	1		reserved			
2B	1		reserved			
2C	1		reserved			
2D	1		reserved			
2E	1		reserved			
2F	1		reserved			
30	1	00 - 01	Lane 4 Switch	Off, On	00	
31	1	00 - 01	Lane 4 FX Receive	Off, On	00	
32	1	00 - 01	Lane 4 Trigger Receive	Off, On	00	
33	1	00 - 04	Lane 4 Sync	Off, Tempo, Beat, Arp, Lane1	00	
34	1	00 - 7F	Lane 4 Speed	0 - 127	3F	This is available only when Sync is set to Off.
35	1	00 - 12	Lane 4 Unit	50%, 66%, 75%, 100%, 133%, 150%, 200%, 266%, 300%, 400%, 600%, 800%, 1200%, 1600%, 2400%, 3200%, 6400%, Common, Arp	03	This is not available when Sync is set to Off.
36	1	00 - 02	Lane 4 Key On Reset	Off, Each-On, 1st-On	00	This is not available when Sync is set to Arp.
37	1	00 - 01	Lane 4 Loop	Off, On	01	
38	1	01 - 7F	Lane 4 Velocity Limit Low	1 - 127	01	
39	1	01 - 7F	Lane 4 Velocity Limit High	1 - 127	7F	
3A	1		reserved			
3B	1		reserved			
3C	1		reserved			
3D	1		reserved			
3E	1		reserved			
3F	1		reserved			

TOTAL SIZE = 64 40 (HEX)

p = Part number
0 - F

Address	Size	Data Range (HEX)	Parameter Name	Description	Default (HEX)	Notes
31	2p	00 - 7F 00 - 7F	Insertion-A Type	Refer to Effect Parameter List	00 00	
02	1	00 - 7F	Insertion-A Preset Number		00	
03	2	00 - 7F 00 - 7F	Insertion-A Parameter 1 MSB Insertion-A Parameter 1 LSB	:	00 00	
05	2	00 - 7F 00 - 7F	Insertion-A Parameter 2 MSB Insertion-A Parameter 2 LSB	:	00 00	
07	2	00 - 7F 00 - 7F	Insertion-A Parameter 3 MSB Insertion-A Parameter 3 LSB	:	00 00	
09	2	00 - 7F 00 - 7F	Insertion-A Parameter 4 MSB Insertion-A Parameter 4 LSB	:	00 00	
0B	2	00 - 7F 00 - 7F	Insertion-A Parameter 5 MSB Insertion-A Parameter 5 LSB	:	00 00	
0D	2	00 - 7F 00 - 7F	Insertion-A Parameter 6 MSB Insertion-A Parameter 6 LSB	:	00 00	
0F	2	00 - 7F 00 - 7F	Insertion-A Parameter 7 MSB Insertion-A Parameter 7 LSB	:	00 00	
11	2	00 - 7F 00 - 7F	Insertion-A Parameter 8 MSB Insertion-A Parameter 8 LSB	:	00 00	
13	2	00 - 7F 00 - 7F	Insertion-A Parameter 9 MSB Insertion-A Parameter 9 LSB	:	00 00	
15	2	00 - 7F 00 - 7F	Insertion-A Parameter 10 MSB Insertion-A Parameter 10 LSB	:	00 00	
17	2	00 - 7F 00 - 7F	Insertion-A Parameter 11 MSB Insertion-A Parameter 11 LSB	:	00 00	
19	2	00 - 7F 00 - 7F	Insertion-A Parameter 12 MSB Insertion-A Parameter 12 LSB	:	00 00	
1B	2	00 - 7F 00 - 7F	Insertion-A Parameter 13 MSB Insertion-A Parameter 13 LSB	:	00 00	
1D	2	00 - 7F 00 - 7F	Insertion-A Parameter 14 MSB Insertion-A Parameter 14 LSB	:	00 00	
1F	2	00 - 7F 00 - 7F	Insertion-A Parameter 15 MSB Insertion-A Parameter 15 LSB	:	00 00	
21	2	00 - 7F 00 - 7F	Insertion-A Parameter 16 MSB Insertion-A Parameter 16 LSB	:	00 00	
23	2	00 - 7F 00 - 7F	Insertion-A Parameter 17 MSB Insertion-A Parameter 17 LSB	:	00 00	

Address	Size	Data Range (HEX)	Parameter Name	Description	Default (HEX)	Notes
25	2	00 - 7F 00 - 7F	Insertion-A Parameter 18 MSB Insertion-A Parameter 18 LSB	:	00 00	
27	2	00 - 7F 00 - 7F	Insertion-A Parameter 19 MSB Insertion-A Parameter 19 LSB	:	00 00	
29	2	00 - 7F 00 - 7F	Insertion-A Parameter 20 MSB Insertion-A Parameter 20 LSB	:	00 00	
2B	2	00 - 7F 00 - 7F	Insertion-A Parameter 21 MSB Insertion-A Parameter 21 LSB	:	00 00	
2D	2	00 - 7F 00 - 7F	Insertion-A Parameter 22 MSB Insertion-A Parameter 22 LSB	:	00 00	
2F	2	00 - 7F 00 - 7F	Insertion-A Parameter 23 MSB Insertion-A Parameter 23 LSB	:	00 00	
31	2	00 - 7F 00 - 7F	Insertion-A Parameter 24 MSB Insertion-A Parameter 24 LSB	:	00 00	
33	2		reserved			
35	2		reserved			
37	2		reserved			
39	2		reserved			
3B	2		reserved			
3D	2		reserved			
3F	2		reserved			
41	2		reserved			
43	1	00 - 11, 7F	Insertion-A Side Chain Part	0: Part 1, 1: Part 2 - 15: Part 16, 16: A/D, 17: Master, 127: Off	127	

TOTAL SIZE = 68 44 (HEX)

p = Part number
0 - F

Address	Size	Data Range (HEX)	Parameter Name	Description	Default (HEX)	Notes		
31	3p	00	2	00 - 7F 00 - 7F	Insertion-B Type	Refer to Effect Parameter List	00 00	
02	1	00 - 7F		Insertion-B Preset Number		00		
03	2	00 - 7F 00 - 7F		Insertion-B Parameter 1 MSB Insertion-B Parameter 1 LSB	:	00 00		
05	2	00 - 7F 00 - 7F		Insertion-B Parameter 2 MSB Insertion-B Parameter 2 LSB	:	00 00		
07	2	00 - 7F 00 - 7F		Insertion-B Parameter 3 MSB Insertion-B Parameter 3 LSB	:	00 00		
09	2	00 - 7F 00 - 7F		Insertion-B Parameter 4 MSB Insertion-B Parameter 4 LSB	:	00 00		
0B	2	00 - 7F 00 - 7F		Insertion-B Parameter 5 MSB Insertion-B Parameter 5 LSB	:	00 00		
0D	2	00 - 7F 00 - 7F		Insertion-B Parameter 6 MSB Insertion-B Parameter 6 LSB	:	00 00		
0F	2	00 - 7F 00 - 7F		Insertion-B Parameter 7 MSB Insertion-B Parameter 7 LSB	:	00 00		
11	2	00 - 7F 00 - 7F		Insertion-B Parameter 8 MSB Insertion-B Parameter 8 LSB	:	00 00		
13	2	00 - 7F 00 - 7F		Insertion-B Parameter 9 MSB Insertion-B Parameter 9 LSB	:	00 00		
15	2	00 - 7F 00 - 7F		Insertion-B Parameter 10 MSB Insertion-B Parameter 10 LSB	:	00 00		
17	2	00 - 7F 00 - 7F		Insertion-B Parameter 11 MSB Insertion-B Parameter 11 LSB	:	00 00		
19	2	00 - 7F 00 - 7F		Insertion-B Parameter 12 MSB Insertion-B Parameter 12 LSB	:	00 00		
1B	2	00 - 7F 00 - 7F		Insertion-B Parameter 13 MSB Insertion-B Parameter 13 LSB	:	00 00		
1D	2	00 - 7F 00 - 7F		Insertion-B Parameter 14 MSB Insertion-B Parameter 14 LSB	:	00 00		
1F	2	00 - 7F 00 - 7F		Insertion-B Parameter 15 MSB Insertion-B Parameter 15 LSB	:	00 00		
21	2	00 - 7F 00 - 7F		Insertion-B Parameter 16 MSB Insertion-B Parameter 16 LSB	:	00 00		
23	2	00 - 7F 00 - 7F		Insertion-B Parameter 17 MSB Insertion-B Parameter 17 LSB	:	00 00		
25	2	00 - 7F 00 - 7F		Insertion-B Parameter 18 MSB Insertion-B Parameter 18 LSB	:	00 00		
27	2	00 - 7F 00 - 7F		Insertion-B Parameter 19 MSB Insertion-B Parameter 19 LSB	:	00 00		
29	2	00 - 7F 00 - 7F		Insertion-B Parameter 20 MSB Insertion-B Parameter 20 LSB	:	00 00		
2B	2	00 - 7F 00 - 7F		Insertion-B Parameter 21 MSB Insertion-B Parameter 21 LSB	:	00 00		
2D	2	00 - 7F 00 - 7F		Insertion-B Parameter 22 MSB Insertion-B Parameter 22 LSB	:	00 00		
2F	2	00 - 7F 00 - 7F		Insertion-B Parameter 23 MSB Insertion-B Parameter 23 LSB	:	00 00		
31	2	00 - 7F 00 - 7F		Insertion-B Parameter 24 MSB Insertion-B Parameter 24 LSB	:	00 00		
33	2			reserved				
35	2			reserved				
37	2			reserved				
39	2			reserved				
3B	2			reserved				
3D	2			reserved				
3F	2			reserved				
41	2			reserved				

Address	Size	Data Range (HEX)	Parameter Name	Description	Default (HEX)	Notes
	43	1	00 - 11, 7F	Insertion-B Side Chain Part	0: Part 1, 1: Part 2 - 15: Part 16, 16: A/D, 17: Master, 127: Off	127

TOTAL SIZE = 68 44 (HEX)

p = Part number
0 - F

Address	Size	Data Range (HEX)	Parameter Name	Description	Default (HEX)	Notes		
31	4p	00	1	00 - 05	LFO Phase	0, 90, 120, 180, 240, 270	00	LFO-related parameters hereinafter are not available for Drum Part.
		01	1	00 - 0C	LFO Wave	Triangle, Triangle+, Saw Up, Saw Down, Squ1/4, Squ1/3, Square, Squ2/3, Squ3/4, Trapezoid, S/H1, S/H2, User	00	
		02	1	00 - 3F	LFO Speed	0 - 63	20	This is available only when Tempo Sync is set to Off.
		03	1	05 - 18	LFO Tempo Speed	5 - 24 (16th, 8th/3, 16th., 8th, 4th/3, 8th., 4th, 2th/3, 4th., 2nd, Whole/3, 2nd., 4thX4, 4thX5, 4thX6, 4thX7, 4thX8, 4thX16, 4thX32, 4thX64)	0B	This is available only when Tempo Sync is set to On.
		04	1	00 - 01	LFO Tempo Sync	Off, On	00	
		05	1	00 - 7F	LFO Delay Time	0 - 127	00	
		06	1	00 - 7F	LFO Fade In Time	0 - 127	00	
		07	1	00 - 7F	LFO Hold Time	0 - 126, Hold	7F	
		08	1	00 - 7F	LFO Fade Out Time	0 - 127	40	
		09	1	00 - 02	LFO Key On Reset	Off, Each-On, 1st-On	02	
		0A	1	00 - 01	LFO Loop Switch	On, Off	00	
		0B	1	00 - 45	LFO Destination 1	0 - 69 (Refer to LFO Box Destination of Control List)	02	
		0C	1	00 - 7F	LFO Depth 1	0 - 127	00	
		0D	1		reserved			
		0E	1	00 - 45	LFO Destination 2	0 - 69 (Refer to LFO Box Destination of Control List)	04	
		0F	1	00 - 7F	LFO Depth 2	0 - 127	00	
		10	1		reserved			
		11	1	00 - 45	LFO Destination 3	0 - 69 (Refer to LFO Box Destination of Control List)	04	
		12	1	00 - 7F	LFO Depth 3	0 - 127	00	
		13	1		reserved			
		14	1	00 - 06	User LFO Cycle	2 steps, 3 steps, 4 steps, 6 steps, 8 steps, 12 steps, 16 steps	06	
		15	1	00 - 03	User LFO Slope	Off, Up, Down, Up&Down	00	
		16	1	00 - 7F	User LFO Step Value 1	-64 - +63	40	
		17	1	00 - 7F	User LFO Step Value 2	-64 - +63	40	
		18	1	00 - 7F	User LFO Step Value 3	-64 - +63	40	
		19	1	00 - 7F	User LFO Step Value 4	-64 - +63	40	
		1A	1	00 - 7F	User LFO Step Value 5	-64 - +63	40	
		1B	1	00 - 7F	User LFO Step Value 6	-64 - +63	40	
		1C	1	00 - 7F	User LFO Step Value 7	-64 - +63	40	
		1D	1	00 - 7F	User LFO Step Value 8	-64 - +63	40	
		1E	1	00 - 7F	User LFO Step Value 9	-64 - +63	40	
		1F	1	00 - 7F	User LFO Step Value 10	-64 - +63	40	
		20	1	00 - 7F	User LFO Step Value 11	-64 - +63	40	
		21	1	00 - 7F	User LFO Step Value 12	-64 - +63	40	
		22	1	00 - 7F	User LFO Step Value 13	-64 - +63	40	
		23	1	00 - 7F	User LFO Step Value 14	-64 - +63	40	
		24	1	00 - 7F	User LFO Step Value 15	-64 - +63	40	
		25	1	00 - 7F	User LFO Step Value 16	-64 - +63	40	
		26	1	00 - 7F	Part LFO Random Speed Depth	0 - 127	00	This is available only when Tempo Sync is set to Off.

TOTAL SIZE = 39 27 (HEX)

p = Part number
0 - F

Address	Size	Data Range (HEX)	Parameter Name	Description	Default (HEX)	Notes	
31	5p	00	1	00 - 01	Zone Switch	Off, On	00
		01	1	00 - 0F, 7F	MIDI Transmit Channel	Ch1 - 16, Off	7F
		02	1	3D - 43	Zone Octave Shift	-3 - +3	40
		03	1	35 - 4B	Zone Transpose	-11 - +11 (semitones)	40
		04	1	00 - 7F	Note Limit Low	C-2 - G8	00
		05	1	00 - 7F	Note Limit High	C-2 - G8	7F
		06	1	00 - 01	Zone Internal Switch	Off, On	01
		07	1	00 - 7F	MIDI Volume	0 - 127	64
		08	1	00 - 7F	MIDI Pan	L64 - C - R63	40
		09	1	00 - 7F	MIDI Bank MSB	0 - 127	00
		0A	1	00 - 7F	MIDI Bank LSB	0 - 127	00
		0B	1	00 - 7F	MIDI Program Number	1 - 128	00
		0C	1	00 - 7F	Transmit Pitch Bend Transmit After Touch Transmit Program Change Transmit Bank Select Transmit Control Change	bit 6: Off, On PB bit 5: Off, On AT bit 4: Off, On Program Change bit 3: Off, On Bank Select bit 2: Off, On Control Change bit1-0: reserved	7C
		0D	1	00 - 7F	Transmit Assignable Knob 8 Transmit Assignable Knob 7 Transmit Assignable Knob 6 Transmit Assignable Knob 5 Transmit Assignable Knob 4 Transmit Assignable Knob 3 Transmit Assignable Knob 2	bit 6: Off, On Assignable Knob 8 bit 5: Off, On Assignable Knob 7 bit 4: Off, On Assignable Knob 6 bit 3: Off, On Assignable Knob 5 bit 2: Off, On Assignable Knob 4 bit 1: Off, On Assignable Knob 3 bit 0: Off, On Assignable Knob 2	7F
		0E	1	00 - 7F	Transmit Assignable Knob 1 Transmit Foot Controller 2 Transmit Foot Controller 1 Transmit Modulation Wheel Transmit Sustain/Sostenuto Transmit Pan Transmit Volume/Expression	bit 6: Off, On Assignable Knob 1 bit 5: Off, On FC2 bit 4: Off, On FC1 bit 3: Off, On MW bit 2: Off, On Sustain/Sostenute bit 1: Off, On Pan bit 0: Off, On Volume/Expression	7F
		0F	1	00 - 7F	Transmit Ribbon Controller Transmit Breath Controller Transmit Foot Switch	bit 6: Off, On RB bit 5: Off, On BC bit 4: Off, On FS bit 3: reserved bit 2: reserved bit 1: reserved bit 0: reserved	70
		10	1	00 - 7F	Transmit Motion Seq Trigger Transmit Motion Seq Hold Transmit Assignable Function 2 Transmit Assignable Function 1	bit 6: Off, On Motion Seq Trigger bit 5: Off, On Motion Seq Hold bit 4: Off, On Assignable Function 2 bit 3: Off, On Assignable Function 1 bit 2: reserved bit 1: reserved bit 0: reserved	78

TOTAL SIZE = 17 11 (HEX)

p = Part number
0 - F

Address	Size	Data Range (HEX)	Parameter Name	Description	Default (HEX)	Notes		
31	6p	00	1	00 - 01	Part Arp Switch	Off, On	00	
		01	1		reserved			
		02	1		reserved			
		03	1	00 - 01	Arp Play Only	Off, On	00	
		04	1	00 - 01	Arp Fixed SD/BD	Off, On	00	Not available for Normal/FM Parts
		05	1		reserved			
		06	1	00 - 01	Arp Loop	Off, On	01	
		07	1	00 - 02	Arp Hold	Sync-Off, Off, On	01	
		08	1	00 - 0A	Part Unit Multiply	50%, 66%, 75%, 100%, 133%, 150%, 200%, 266%, 300%, 400%, Common	03	
		09	1	00 - 7F	Arp Note Limit Low	C-2 - G8	00	
		0A	1	00 - 7F	Arp Note Limit High	C-2 - G8	7F	
		0B	1	01 - 7F	Arp Velocity Limit Low	1 - 127	01	
		0C	1	01 - 7F	Arp Velocity Limit High	1 - 127	7F	
		0D	1	00 - 04	Arp Key Mode	Sort, Thru, Direct, Sort+Drct, Thru+Drct	00	
		0E	1	00 - 01	Arp Velocity Mode	Original, Thru	00	
		0F	1	00 - 01	Arp Change Timing	Real-time, Measure	01	
		10	1	01 - 07	Arp / Motion Seq Gird	60, 80, 120, 160, 240, 320, 480	03	
		11	1	00 - 64	Arp Quantize Strength	0 - 100%	00	

Address	Size	Data Range (HEX)	Parameter Name	Description	Default (HEX)	Notes
12	2	00-01 00-7F	Arp Velocity Rate	0-200% 1st bit6-0 → bit13-7 2nd bit6-0 → bit6-0	00 64	
14	2	00-01 00-7F	Arp Gate Time Rate	0-200% 1st bit6-0 → bit13-7 2nd bit6-0 → bit6-0	00 64	
16	2		reserved			
18	2		reserved			
1A	2		reserved			
1C	1	00-7F	Arp Accent Velocity Threshold	Off, 1-127	40	
1D	1	00-01	Arp Accent Start Quantize	Off, On	01	
1E	1	3D-43	Arp Octave Range	-3-0-+3	40	
1F	1	36-4A	Arp Output Octave Shift	-10-0-+10	40	
20	1	00-01	Arp Trigger Mode	Gate, Toggle	00	
21	1	00-01	Arp Random SFX	Off, On	01	
22	1	00-01	Arp Random SFX Key On Control	Off, On	01	
23	1	00-7F	Arp Random SFX Velocity Offset	-64-0-+63	40	
24	2	00-01 00-7F	Arp 1 Velocity Rate Offset	-100-0-+100 1st bit6-0 → bit13-7 2nd bit6-0 → bit6-0	01 00	
26	2	00-01 00-7F	Arp 1 Gate Time Rate Offset	:	01 00	
28	2	00-01 00-7F	Arp 2 Velocity Rate Offset	:	01 00	
2A	2	00-01 00-7F	Arp 2 Gate Time Rate Offset	:	01 00	
2C	2	00-01 00-7F	Arp 3 Velocity Rate Offset	:	01 00	
2E	2	00-01 00-7F	Arp 3 Gate Time Rate Offset	:	01 00	
30	2	00-01 00-7F	Arp 4 Velocity Rate Offset	:	01 00	
32	2	00-01 00-7F	Arp 4 Gate Time Rate Offset	:	01 00	
34	2	00-01 00-7F	Arp 5 Velocity Rate Offset	:	01 00	
36	2	00-01 00-7F	Arp 5 Gate Time Rate Offset	:	01 00	
38	2	00-01 00-7F	Arp 6 Velocity Rate Offset	:	01 00	
3A	2	00-01 00-7F	Arp 6 Gate Time Rate Offset	:	01 00	
3C	2	00-01 00-7F	Arp 7 Velocity Rate Offset	:	01 00	
3E	2	00-01 00-7F	Arp 7 Gate Time Rate Offset	:	01 00	
40	2	00-01 00-7F	Arp 8 Velocity Rate Offset	:	01 00	
42	2	00-01 00-7F	Arp 8 Gate Time Rate Offset	:	01 00	
			reserved			
44	1		reserved			
45	2	00-7F 00-7F	Arp 1 Number	Preset (0 = Off, 1-10000), User, Library (see the following chart) 1st bit6-0 → bit13-7 2nd bit6-0 → bit6-0	00 01	
47	1		reserved			
48	2	00-7F 00-7F	Arp 2 Number	Preset (0 = Off, 1-10000), User, Library (see the following chart) 1st bit6-0 → bit13-7 2nd bit6-0 → bit6-0	00 00	Off
4A	1		reserved			
4B	2	00-7F 00-7F	Arp 3 Number	Preset (0 = Off, 1-10000), User, Library (see the following chart) 1st bit6-0 → bit13-7 2nd bit6-0 → bit6-0	00 00	Off
4D	1		reserved			
4E	2	00-7F 00-7F	Arp 4 Number	Preset (0 = Off, 1-10000), User, Library (see the following chart) 1st bit6-0 → bit13-7 2nd bit6-0 → bit6-0	00 00	Off
50	1		reserved			
51	2	00-7F 00-7F	Arp 5 Number	Preset (0 = Off, 1-10000), User, Library (see the following chart) 1st bit6-0 → bit13-7 2nd bit6-0 → bit6-0	00 00	Off
53	1		reserved			
54	2	00-7F 00-7F	Arp 6 Number	Preset (0 = Off, 1-10000), User, Library (see the following chart) 1st bit6-0 → bit13-7 2nd bit6-0 → bit6-0	00 00	Off
56	1		reserved			
57	2	00-7F 00-7F	Arp 7 Number	Preset (0 = Off, 1-10000), User, Library (see the following chart) 1st bit6-0 → bit13-7 2nd bit6-0 → bit6-0	00 00	Off

Address	Size	Data Range (HEX)	Parameter Name	Description	Default (HEX)	Notes
59	1		reserved			
5A	2	00-7F 00-7F	Arp 8 Number	Preset (0 = Off, 1-10000), User, Library (see the following chart) 1st bit6-0 → bit13-7 2nd bit6-0 → bit6-0	00 00	Off

TOTAL SIZE = 92 5C (HEX)

p = Part number
0 - F

Bank	Data Range	Description
User	10240 ... 10495	001 ... 256
Library1	10496 ... 10751	001 ... 256
Library2	10752 ... 11007	001 ... 256
Library3	11008 ... 11263	001 ... 256
Library4	11264 ... 11519	001 ... 256
Library5	11520 ... 11775	001 ... 256
Library6	11776 ... 12031	001 ... 256
Library7	12032 ... 12287	001 ... 256
Library8	12288 ... 12543	001 ... 256

Address	Size	Data Range (HEX)	Parameter Name	Description	Default (HEX)	Notes	
32	sp	00	1	00-7F	Lane 1 Motion Seq Amplitude	0-127	40
		01	1	00-7F	Lane 1 Motion Seq Smoothness	0-127	00
		02	1	00-0F	Lane 1 Motion Seq Cycle	1-16	0F
		03	1	00-01	Lane 1 Motion Seq Polarity	Unipolar, Bipolar	00
		04	1	00-7F	Lane 1 Motion Seq Step 1 Value	0-127	40
		05	1	00-7F	Lane 1 Motion Seq Step 2 Value	0-127	40
		06	1	00-7F	Lane 1 Motion Seq Step 3 Value	0-127	40
		07	1	00-7F	Lane 1 Motion Seq Step 4 Value	0-127	40
		08	1	00-7F	Lane 1 Motion Seq Step 5 Value	0-127	40
		09	1	00-7F	Lane 1 Motion Seq Step 6 Value	0-127	40
		0A	1	00-7F	Lane 1 Motion Seq Step 7 Value	0-127	40
		0B	1	00-7F	Lane 1 Motion Seq Step 8 Value	0-127	40
		0C	1	00-7F	Lane 1 Motion Seq Step 9 Value	0-127	40
		0D	1	00-7F	Lane 1 Motion Seq Step 10 Value	0-127	40
		0E	1	00-7F	Lane 1 Motion Seq Step 11 Value	0-127	40
		0F	1	00-7F	Lane 1 Motion Seq Step 12 Value	0-127	40
		10	1	00-7F	Lane 1 Motion Seq Step 13 Value	0-127	40
		11	1	00-7F	Lane 1 Motion Seq Step 14 Value	0-127	40
		12	1	00-7F	Lane 1 Motion Seq Step 15 Value	0-127	40
		13	1	00-7F	Lane 1 Motion Seq Step 16 Value	0-127	40
		14	1	00-01	Lane 1 Motion Seq Step 1 Type	A, B	00
		15	1	00-01	Lane 1 Motion Seq Step 2 Type	A, B	00
		16	1	00-01	Lane 1 Motion Seq Step 3 Type	A, B	00
		17	1	00-01	Lane 1 Motion Seq Step 4 Type	A, B	00
		18	1	00-01	Lane 1 Motion Seq Step 5 Type	A, B	00
		19	1	00-01	Lane 1 Motion Seq Step 6 Type	A, B	00
		1A	1	00-01	Lane 1 Motion Seq Step 7 Type	A, B	00
		1B	1	00-01	Lane 1 Motion Seq Step 8 Type	A, B	00
		1C	1	00-01	Lane 1 Motion Seq Step 9 Type	A, B	00
		1D	1	00-01	Lane 1 Motion Seq Step 10 Type	A, B	00
		1E	1	00-01	Lane 1 Motion Seq Step 11 Type	A, B	00
		1F	1	00-01	Lane 1 Motion Seq Step 12 Type	A, B	00
		20	1	00-01	Lane 1 Motion Seq Step 13 Type	A, B	00
		21	1	00-01	Lane 1 Motion Seq Step 14 Type	A, B	00
		22	1	00-01	Lane 1 Motion Seq Step 15 Type	A, B	00
		23	1	00-01	Lane 1 Motion Seq Step 16 Type	A, B	00
		24	1	00-09	Lane 1 Motion Seq Step Curve A Bank	0 = Preset, 1 = User, 2 = Library 1...9 = Library 8	00
		25	1	00-1F	Lane 1 Motion Seq Step Curve A Type	0-31 (0-17 when Bank is set to Preset)	00
		26	1	00-7F	Lane 1 Motion Seq Step Curve A Parameter 1	0-127	05
		27	1	00-7F	Lane 1 Motion Seq Step Curve A Parameter 2	0-127	00
		28	1	00-01	Lane 1 Motion Seq Step Curve A Shape Control SW1	Off, On	00
		29	1	00-01	Lane 1 Motion Seq Step Curve A Shape Control SW2	Off, On	00
		2A	1	00-01	Lane 1 Motion Seq Step Curve A Direction	Forward, Reverse	00
		2B	1	00-09	Lane 1 Motion Seq Step Curve B Bank	0 = Preset, 1 = User, 2 = Library 1...9 = Library 8	00
		2C	1	00-1F	Lane 1 Motion Seq Step Curve B Type	0-31 (0-17 when Bank is set to Preset)	00
		2D	1	00-7F	Lane 1 Motion Seq Step Curve B Parameter 1	0-127	05
		2E	1	00-7F	Lane 1 Motion Seq Step Curve B Parameter 2	0-127	00

Address	Size	Data Range (HEX)	Parameter Name	Description	Default (HEX)	Notes
	2F	1	00 - 01	Lane 1 Motion Seq Step Curve B Shape Control SW1	Off, On	00
	30	1	00 - 01	Lane 1 Motion Seq Step Curve B Shape Control SW2	Off, On	00
	31	1	00 - 01	Lane 1 Motion Seq Step Curve B Direction	Forward, Reverse	00

TOTAL SIZE = 50 32 (HEX)

s = Sequence number
0 - 7

p = Part number
0 - F

Address	Size	Data Range (HEX)	Parameter Name	Description	Default (HEX)	Notes	
33	sp	00	1	00 - 7F	Lane 2 Motion Seq Amplitude	0 - 127	40
		01	1	00 - 7F	Lane 2 Motion Seq Smoothness	0 - 127	00
		02	1	00 - 07	Lane 2 Motion Seq Cycle	1 - 16	0F
		03	1	00 - 01	Lane 2 Motion Seq Polarity	Unipolar, Bipolar	00
		04	1	00 - 7F	Lane 2 Motion Seq Step 1 Value	0 - 127	40
		05	1	00 - 7F	Lane 2 Motion Seq Step 2 Value	0 - 127	40
		06	1	00 - 7F	Lane 2 Motion Seq Step 3 Value	0 - 127	40
		07	1	00 - 7F	Lane 2 Motion Seq Step 4 Value	0 - 127	40
		08	1	00 - 7F	Lane 2 Motion Seq Step 5 Value	0 - 127	40
		09	1	00 - 7F	Lane 2 Motion Seq Step 6 Value	0 - 127	40
		0A	1	00 - 7F	Lane 2 Motion Seq Step 7 Value	0 - 127	40
		0B	1	00 - 7F	Lane 2 Motion Seq Step 8 Value	0 - 127	40
		0C	1	00 - 7F	Lane 2 Motion Seq Step 9 Value	0 - 127	40
		0D	1	00 - 7F	Lane 2 Motion Seq Step 10 Value	0 - 127	40
		0E	1	00 - 7F	Lane 2 Motion Seq Step 11 Value	0 - 127	40
		0F	1	00 - 7F	Lane 2 Motion Seq Step 12 Value	0 - 127	40
		10	1	00 - 7F	Lane 2 Motion Seq Step 13 Value	0 - 127	40
		11	1	00 - 7F	Lane 2 Motion Seq Step 14 Value	0 - 127	40
		12	1	00 - 7F	Lane 2 Motion Seq Step 15 Value	0 - 127	40
		13	1	00 - 7F	Lane 2 Motion Seq Step 16 Value	0 - 127	40
		14	1	00 - 01	Lane 2 Motion Seq Step 1 Type	A, B	00
		15	1	00 - 01	Lane 2 Motion Seq Step 2 Type	A, B	00
		16	1	00 - 01	Lane 2 Motion Seq Step 3 Type	A, B	00
		17	1	00 - 01	Lane 2 Motion Seq Step 4 Type	A, B	00
		18	1	00 - 01	Lane 2 Motion Seq Step 5 Type	A, B	00
		19	1	00 - 01	Lane 2 Motion Seq Step 6 Type	A, B	00
		1A	1	00 - 01	Lane 2 Motion Seq Step 7 Type	A, B	00
		1B	1	00 - 01	Lane 2 Motion Seq Step 8 Type	A, B	00
		1C	1	00 - 01	Lane 2 Motion Seq Step 9 Type	A, B	00
		1D	1	00 - 01	Lane 2 Motion Seq Step 10 Type	A, B	00
		1E	1	00 - 01	Lane 2 Motion Seq Step 11 Type	A, B	00
		1F	1	00 - 01	Lane 2 Motion Seq Step 12 Type	A, B	00
		20	1	00 - 01	Lane 2 Motion Seq Step 13 Type	A, B	00
		21	1	00 - 01	Lane 2 Motion Seq Step 14 Type	A, B	00
		22	1	00 - 01	Lane 2 Motion Seq Step 15 Type	A, B	00
		23	1	00 - 01	Lane 2 Motion Seq Step 16 Type	A, B	00
		24	1	00 - 09	Lane 2 Motion Seq Step Curve A Bank	0 = Preset, 1 = User, 2 = Library 1...9 = Library 8	00
		25	1	00 - 1F	Lane 2 Motion Seq Step Curve A Type	0 - 31 (0 - 17 when Bank is set to Preset)	00
		26	1	00 - 7F	Lane 2 Motion Seq Step Curve A Parameter 1	0 - 127	05
		27	1	00 - 7F	Lane 2 Motion Seq Step Curve A Parameter 2	0 - 127	00
		28	1	00 - 01	Lane 2 Motion Seq Step Curve A Shape Control SW1	Off, On	00
		29	1	00 - 01	Lane 2 Motion Seq Step Curve A Shape Control SW2	Off, On	00
		2A	1	00 - 01	Lane 2 Motion Seq Step Curve A Direction	Forward, Reverse	00
		2B	1	00 - 09	Lane 2 Motion Seq Step Curve B Bank	0 = Preset, 1 = User, 2 = Library 1...9 = Library 8	00
		2C	1	00 - 1F	Lane 2 Motion Seq Step Curve B Type	0 - 31 (0 - 17 when Bank is set to Preset)	00
		2D	1	00 - 7F	Lane 2 Motion Seq Step Curve B Parameter 1	0 - 127	05
		2E	1	00 - 7F	Lane 2 Motion Seq Step Curve B Parameter 2	0 - 127	00
		2F	1	00 - 01	Lane 2 Motion Seq Step Curve B Shape Control SW1	Off, On	00
		30	1	00 - 01	Lane 2 Motion Seq Step Curve B Shape Control SW2	Off, On	00
		31	1	00 - 01	Lane 2 Motion Seq Step Curve B Direction	Forward, Reverse	00

TOTAL SIZE = 50 32 (HEX)

s = Sequence number
0 - 7

p = Part number
0 - F

Address	Size	Data Range (HEX)	Parameter Name	Description	Default (HEX)	Notes	
34	sp	00	1	00 - 7F	Lane 3 Motion Seq Amplitude	0 - 127	40
		01	1	00 - 7F	Lane 3 Motion Seq Smoothness	0 - 127	00
		02	1	00 - 07	Lane 3 Motion Seq Cycle	1 - 16	0F
		03	1	00 - 01	Lane 3 Motion Seq Polarity	Unipolar, Bipolar	00
		04	1	00 - 7F	Lane 3 Motion Seq Step 1 Value	0 - 127	40
		05	1	00 - 7F	Lane 3 Motion Seq Step 2 Value	0 - 127	40
		06	1	00 - 7F	Lane 3 Motion Seq Step 3 Value	0 - 127	40
		07	1	00 - 7F	Lane 3 Motion Seq Step 4 Value	0 - 127	40
		08	1	00 - 7F	Lane 3 Motion Seq Step 5 Value	0 - 127	40
		09	1	00 - 7F	Lane 3 Motion Seq Step 6 Value	0 - 127	40
		0A	1	00 - 7F	Lane 3 Motion Seq Step 7 Value	0 - 127	40
		0B	1	00 - 7F	Lane 3 Motion Seq Step 8 Value	0 - 127	40
		0C	1	00 - 7F	Lane 3 Motion Seq Step 9 Value	0 - 127	40
		0D	1	00 - 7F	Lane 3 Motion Seq Step 10 Value	0 - 127	40
		0E	1	00 - 7F	Lane 3 Motion Seq Step 11 Value	0 - 127	40
		0F	1	00 - 7F	Lane 3 Motion Seq Step 12 Value	0 - 127	40
		10	1	00 - 7F	Lane 3 Motion Seq Step 13 Value	0 - 127	40
		11	1	00 - 7F	Lane 3 Motion Seq Step 14 Value	0 - 127	40
		12	1	00 - 7F	Lane 3 Motion Seq Step 15 Value	0 - 127	40
		13	1	00 - 7F	Lane 3 Motion Seq Step 16 Value	0 - 127	40
		14	1	00 - 01	Lane 3 Motion Seq Step 1 Type	A, B	00
		15	1	00 - 01	Lane 3 Motion Seq Step 2 Type	A, B	00
		16	1	00 - 01	Lane 3 Motion Seq Step 3 Type	A, B	00
		17	1	00 - 01	Lane 3 Motion Seq Step 4 Type	A, B	00
		18	1	00 - 01	Lane 3 Motion Seq Step 5 Type	A, B	00
		19	1	00 - 01	Lane 3 Motion Seq Step 6 Type	A, B	00
		1A	1	00 - 01	Lane 3 Motion Seq Step 7 Type	A, B	00
		1B	1	00 - 01	Lane 3 Motion Seq Step 8 Type	A, B	00
		1C	1	00 - 01	Lane 3 Motion Seq Step 9 Type	A, B	00
		1D	1	00 - 01	Lane 3 Motion Seq Step 10 Type	A, B	00
		1E	1	00 - 01	Lane 3 Motion Seq Step 11 Type	A, B	00
		1F	1	00 - 01	Lane 3 Motion Seq Step 12 Type	A, B	00
		20	1	00 - 01	Lane 3 Motion Seq Step 13 Type	A, B	00
		21	1	00 - 01	Lane 3 Motion Seq Step 14 Type	A, B	00
		22	1	00 - 01	Lane 3 Motion Seq Step 15 Type	A, B	00
		23	1	00 - 01	Lane 3 Motion Seq Step 16 Type	A, B	00
		24	1	00 - 09	Lane 3 Motion Seq Step Curve A Bank	0 = Preset, 1 = User, 2 = Library 1...9 = Library 8	00
		25	1	00 - 1F	Lane 3 Motion Seq Step Curve A Type	0 - 31 (0 - 17 when Bank is set to Preset)	00
		26	1	00 - 7F	Lane 3 Motion Seq Step Curve A Parameter 1	0 - 127	05
		27	1	00 - 7F	Lane 3 Motion Seq Step Curve A Parameter 2	0 - 127	00
		28	1	00 - 01	Lane 3 Motion Seq Step Curve A Shape Control SW1	Off, On	00
		29	1	00 - 01	Lane 3 Motion Seq Step Curve A Shape Control SW2	Off, On	00
		2A	1	00 - 01	Lane 3 Motion Seq Step Curve A Direction	Forward, Reverse	00
		2B	1	00 - 09	Lane 3 Motion Seq Step Curve B Bank	0 = Preset, 1 = User, 2 = Library 1...9 = Library 8	00
		2C	1	00 - 1F	Lane 3 Motion Seq Step Curve B Type	0 - 31 (0 - 17 when Bank is set to Preset)	00
		2D	1	00 - 7F	Lane 3 Motion Seq Step Curve B Parameter 1	0 - 127	05
		2E	1	00 - 7F	Lane 3 Motion Seq Step Curve B Parameter 2	0 - 127	00
		2F	1	00 - 01	Lane 3 Motion Seq Step Curve B Shape Control SW1	Off, On	00
		30	1	00 - 01	Lane 3 Motion Seq Step Curve B Shape Control SW2	Off, On	00
		31	1	00 - 01	Lane 3 Motion Seq Step Curve B Direction	Forward, Reverse	00

TOTAL SIZE = 50 32 (HEX)

s = Sequence number
0 - 7

p = Part number
0 - F

Address	Size	Data Range (HEX)	Parameter Name	Description	Default (HEX)	Notes
35	sp	00 1	00-7F	Lane 4 Motion Seq Amplitude	0-127	40
		01 1	00-7F	Lane 4 Motion Seq Smoothness	0-127	00
		02 1	00-07	Lane 4 Motion Seq Cycle	1-16	0F
		03 1	00-01	Lane 4 Motion Seq Polarity	Unipolar, Bipolar	00
		04 1	00-7F	Lane 4 Motion Seq Step 1 Value	0-127	40
		05 1	00-7F	Lane 4 Motion Seq Step 2 Value	0-127	40
		06 1	00-7F	Lane 4 Motion Seq Step 3 Value	0-127	40
		07 1	00-7F	Lane 4 Motion Seq Step 4 Value	0-127	40
		08 1	00-7F	Lane 4 Motion Seq Step 5 Value	0-127	40
		09 1	00-7F	Lane 4 Motion Seq Step 6 Value	0-127	40
		0A 1	00-7F	Lane 4 Motion Seq Step 7 Value	0-127	40
		0B 1	00-7F	Lane 4 Motion Seq Step 8 Value	0-127	40
		0C 1	00-7F	Lane 4 Motion Seq Step 9 Value	0-127	40
		0D 1	00-7F	Lane 4 Motion Seq Step 10 Value	0-127	40
		0E 1	00-7F	Lane 4 Motion Seq Step 11 Value	0-127	40
		0F 1	00-7F	Lane 4 Motion Seq Step 12 Value	0-127	40
		10 1	00-7F	Lane 4 Motion Seq Step 13 Value	0-127	40
		11 1	00-7F	Lane 4 Motion Seq Step 14 Value	0-127	40
		12 1	00-7F	Lane 4 Motion Seq Step 15 Value	0-127	40
		13 1	00-7F	Lane 4 Motion Seq Step 16 Value	0-127	40
		14 1	00-01	Lane 4 Motion Seq Step 1 Type	A, B	00
		15 1	00-01	Lane 4 Motion Seq Step 2 Type	A, B	00
		16 1	00-01	Lane 4 Motion Seq Step 3 Type	A, B	00
		17 1	00-01	Lane 4 Motion Seq Step 4 Type	A, B	00
		18 1	00-01	Lane 4 Motion Seq Step 5 Type	A, B	00
		19 1	00-01	Lane 4 Motion Seq Step 6 Type	A, B	00
		1A 1	00-01	Lane 4 Motion Seq Step 7 Type	A, B	00
		1B 1	00-01	Lane 4 Motion Seq Step 8 Type	A, B	00
		1C 1	00-01	Lane 4 Motion Seq Step 9 Type	A, B	00
		1D 1	00-01	Lane 4 Motion Seq Step 10 Type	A, B	00
		1E 1	00-01	Lane 4 Motion Seq Step 11 Type	A, B	00
		1F 1	00-01	Lane 4 Motion Seq Step 12 Type	A, B	00
		20 1	00-01	Lane 4 Motion Seq Step 13 Type	A, B	00
		21 1	00-01	Lane 4 Motion Seq Step 14 Type	A, B	00
		22 1	00-01	Lane 4 Motion Seq Step 15 Type	A, B	00
		23 1	00-01	Lane 4 Motion Seq Step 16 Type	A, B	00
		24 1	00-09	Lane 4 Motion Seq Step Curve A Bank	0 = Preset, 1 = User, 2 = Library1..9 = Library8	00
		25 1	00-1F	Lane 4 Motion Seq Step Curve A Type	0-31 (0-17 when Bank is set to Preset)	00
		26 1	00-7F	Lane 4 Motion Seq Step Curve A Parameter 1	0-127	05
		27 1	00-7F	Lane 4 Motion Seq Step Curve A Parameter 2	0-127	00
		28 1	00-01	Lane 4 Motion Seq Step Curve A Shape Control SW1	Off, On	00
		29 1	00-01	Lane 4 Motion Seq Step Curve A Shape Control SW2	Off, On	00
		2A 1	00-01	Lane 4 Motion Seq Step Curve A Direction	Forward, Reverse	00
		2B 1	00-09	Lane 4 Motion Seq Step Curve B Bank	0 = Preset, 1 = User, 2 = Library1..9 = Library8	00
		2C 1	00-1F	Lane 4 Motion Seq Step Curve B Type	0-31 (0-17 when Bank is set to Preset)	00
		2D 1	00-7F	Lane 4 Motion Seq Step Curve B Parameter 1	0-127	05
		2E 1	00-7F	Lane 4 Motion Seq Step Curve B Parameter 2	0-127	00
		2F 1	00-01	Lane 4 Motion Seq Step Curve B Shape Control SW1	Off, On	00
		30 1	00-01	Lane 4 Motion Seq Step Curve B Shape Control SW2	Off, On	00
		31 1	00-01	Lane 4 Motion Seq Step Curve B Direction	Forward, Reverse	00

TOTAL SIZE = 50 32 (HEX)

s = Sequence number
0-7

p = Part number
0-F

Address	Size	Data Range (HEX)	Parameter Name	Description	Default (HEX)	Notes
36	cp	00 1	00-01	Part Mute	Off, On	00
		01 1	00-7F	Volume	0-127	64
		02 1	01-7F	Pan	L63-C-R63	40
		03 1	00-7F	Reverb Send	0-127	0C
		04 1	00-7F	Variation Send	0-127	00
		05 1	00-7F	Dry Level	0-127	7F
		06 1	00-7F	Filter Cutoff Frequency	-64-+63	40
		07 1	00-7F	Filter Resonance/Width	-64-+63	40
		08 1	00-7F	FEG Depth	-64-+63	40
		09 1	00-7F	AEG Attack Time	-64-+63	40
		0A 1	00-7F	AEG Decay Time	-64-+63	40
		0B 1	00-7F	AEG Sustain Level	-64-+63	40
		0C 1	00-7F	AEG Release Time	-64-+63	40
		0D 1		reserved		
		0E 1		reserved		
		0F 2	00-01 00-7F	Swing	-120-0-+120 1st bit6-0 → bit13-7 2nd bit6-0 → bit6-0	01 00
		11 1	00-0A	Unit Multiply	50%, 66%, 75%, 100%, 133%, 150%, 200%, 266%, 300%, 400%, Common	03
		12 2	00-01 00-7F	Arp Gate Time Rate	0-200% 1st bit6-0 → bit13-7 2nd bit6-0 → bit6-0	00 64
		14 2	00-01 00-7F	Arp Velocity Rate	0-200% 1st bit6-0 → bit13-7 2nd bit6-0 → bit6-0	00 64
		16 1	00-7F	Motion Seq Amplitude Part Offset	-64-+63	40
		17 1	0E-72	Motion Seq Pulse Shape Part Offset	-100, -98-0-+98, +100	40
		18 1	00-7F	Motion Seq Smoothness Part Offset	-64-+63	40
		19 1	00-7F	Motion Seq Random	0-127	00

TOTAL SIZE = 26 1A (HEX)

c = Scene number
0-7

p = Part number
0-F

Address	Size	Data Range (HEX)	Parameter Name	Description	Default (HEX)	Notes
37	0p	00 1	00, 20-7E	Assignable Knob1 Name 1	0, 32-126 (ASCII)	Assign 1
		01 1	00, 20-7E	Assignable Knob1 Name 2	0, 32-126 (ASCII)	
		02 1	00, 20-7E	Assignable Knob1 Name 3	0, 32-126 (ASCII)	
		03 1	00, 20-7E	Assignable Knob1 Name 4	0, 32-126 (ASCII)	
		04 1	00, 20-7E	Assignable Knob1 Name 5	0, 32-126 (ASCII)	
		05 1	00, 20-7E	Assignable Knob1 Name 6	0, 32-126 (ASCII)	
		06 1	00, 20-7E	Assignable Knob1 Name 7	0, 32-126 (ASCII)	
		07 1	00, 20-7E	Assignable Knob1 Name 8	0, 32-126 (ASCII)	
		08 1	00, 20-7E	Assignable Knob1 Name 9	0, 32-126 (ASCII)	
		09 1	00, 20-7E	Assignable Knob1 Name 10	0, 32-126 (ASCII)	
		0A 1	00, 20-7E	Assignable Knob1 Name 11	0, 32-126 (ASCII)	
		0B 1	00, 20-7E	Assignable Knob1 Name 12	0, 32-126 (ASCII)	
		0C 1	00, 20-7E	Assignable Knob1 Name 13	0, 32-126 (ASCII)	
		0D 1	00, 20-7E	Assignable Knob1 Name 14	0, 32-126 (ASCII)	
		0E 1	00, 20-7E	Assignable Knob1 Name 15	0, 32-126 (ASCII)	
		0F 1	00, 20-7E	Assignable Knob1 Name 16	0, 32-126 (ASCII)	
		10 1	00, 20-7E	Assignable Knob2 Name 1	0, 32-126 (ASCII)	Assign 2
		11 1	00, 20-7E	Assignable Knob2 Name 2	0, 32-126 (ASCII)	
		12 1	00, 20-7E	Assignable Knob2 Name 3	0, 32-126 (ASCII)	
		13 1	00, 20-7E	Assignable Knob2 Name 4	0, 32-126 (ASCII)	
		14 1	00, 20-7E	Assignable Knob2 Name 5	0, 32-126 (ASCII)	
		15 1	00, 20-7E	Assignable Knob2 Name 6	0, 32-126 (ASCII)	
		16 1	00, 20-7E	Assignable Knob2 Name 7	0, 32-126 (ASCII)	
		17 1	00, 20-7E	Assignable Knob2 Name 8	0, 32-126 (ASCII)	
		18 1	00, 20-7E	Assignable Knob2 Name 9	0, 32-126 (ASCII)	
		19 1	00, 20-7E	Assignable Knob2 Name 10	0, 32-126 (ASCII)	
		1A 1	00, 20-7E	Assignable Knob2 Name 11	0, 32-126 (ASCII)	
		1B 1	00, 20-7E	Assignable Knob2 Name 12	0, 32-126 (ASCII)	
		1C 1	00, 20-7E	Assignable Knob2 Name 13	0, 32-126 (ASCII)	
		1D 1	00, 20-7E	Assignable Knob2 Name 14	0, 32-126 (ASCII)	
		1E 1	00, 20-7E	Assignable Knob2 Name 15	0, 32-126 (ASCII)	
		1F 1	00, 20-7E	Assignable Knob2 Name 16	0, 32-126 (ASCII)	

Address	Size	Data Range (HEX)	Parameter Name	Description	Default (HEX)	Notes	
	20	1	00, 20 - 7E	Assignable Knob3 Name 1	0, 32 - 126 (ASCII)	Assign 3	
	21	1	00, 20 - 7E	Assignable Knob3 Name 2	0, 32 - 126 (ASCII)		
	22	1	00, 20 - 7E	Assignable Knob3 Name 3	0, 32 - 126 (ASCII)		
	23	1	00, 20 - 7E	Assignable Knob3 Name 4	0, 32 - 126 (ASCII)		
	24	1	00, 20 - 7E	Assignable Knob3 Name 5	0, 32 - 126 (ASCII)		
	25	1	00, 20 - 7E	Assignable Knob3 Name 6	0, 32 - 126 (ASCII)		
	26	1	00, 20 - 7E	Assignable Knob3 Name 7	0, 32 - 126 (ASCII)		
	27	1	00, 20 - 7E	Assignable Knob3 Name 8	0, 32 - 126 (ASCII)		
	28	1	00, 20 - 7E	Assignable Knob3 Name 9	0, 32 - 126 (ASCII)		
	29	1	00, 20 - 7E	Assignable Knob3 Name 10	0, 32 - 126 (ASCII)		
	2A	1	00, 20 - 7E	Assignable Knob3 Name 11	0, 32 - 126 (ASCII)		
	2B	1	00, 20 - 7E	Assignable Knob3 Name 12	0, 32 - 126 (ASCII)		
	2C	1	00, 20 - 7E	Assignable Knob3 Name 13	0, 32 - 126 (ASCII)		
	2D	1	00, 20 - 7E	Assignable Knob3 Name 14	0, 32 - 126 (ASCII)		
	2E	1	00, 20 - 7E	Assignable Knob3 Name 15	0, 32 - 126 (ASCII)		
	2F	1	00, 20 - 7E	Assignable Knob3 Name 16	0, 32 - 126 (ASCII)		
	30	1	00, 20 - 7E	Assignable Knob4 Name 1	0, 32 - 126 (ASCII)		Assign 4
	31	1	00, 20 - 7E	Assignable Knob4 Name 2	0, 32 - 126 (ASCII)		
	32	1	00, 20 - 7E	Assignable Knob4 Name 3	0, 32 - 126 (ASCII)		
	33	1	00, 20 - 7E	Assignable Knob4 Name 4	0, 32 - 126 (ASCII)		
	34	1	00, 20 - 7E	Assignable Knob4 Name 5	0, 32 - 126 (ASCII)		
	35	1	00, 20 - 7E	Assignable Knob4 Name 6	0, 32 - 126 (ASCII)		
	36	1	00, 20 - 7E	Assignable Knob4 Name 7	0, 32 - 126 (ASCII)		
	37	1	00, 20 - 7E	Assignable Knob4 Name 8	0, 32 - 126 (ASCII)		
	38	1	00, 20 - 7E	Assignable Knob4 Name 9	0, 32 - 126 (ASCII)		
	39	1	00, 20 - 7E	Assignable Knob4 Name 10	0, 32 - 126 (ASCII)		
	3A	1	00, 20 - 7E	Assignable Knob4 Name 11	0, 32 - 126 (ASCII)		
	3B	1	00, 20 - 7E	Assignable Knob4 Name 12	0, 32 - 126 (ASCII)		
	3C	1	00, 20 - 7E	Assignable Knob4 Name 13	0, 32 - 126 (ASCII)		
	3D	1	00, 20 - 7E	Assignable Knob4 Name 14	0, 32 - 126 (ASCII)		
	3E	1	00, 20 - 7E	Assignable Knob4 Name 15	0, 32 - 126 (ASCII)		
	3F	1	00, 20 - 7E	Assignable Knob4 Name 16	0, 32 - 126 (ASCII)		
	40	1	00, 20 - 7E	Assignable Knob5 Name 1	0, 32 - 126 (ASCII)	Assign 5	
	41	1	00, 20 - 7E	Assignable Knob5 Name 2	0, 32 - 126 (ASCII)		
	42	1	00, 20 - 7E	Assignable Knob5 Name 3	0, 32 - 126 (ASCII)		
	43	1	00, 20 - 7E	Assignable Knob5 Name 4	0, 32 - 126 (ASCII)		
	44	1	00, 20 - 7E	Assignable Knob5 Name 5	0, 32 - 126 (ASCII)		
	45	1	00, 20 - 7E	Assignable Knob5 Name 6	0, 32 - 126 (ASCII)		
	46	1	00, 20 - 7E	Assignable Knob5 Name 7	0, 32 - 126 (ASCII)		
	47	1	00, 20 - 7E	Assignable Knob5 Name 8	0, 32 - 126 (ASCII)		
	48	1	00, 20 - 7E	Assignable Knob5 Name 9	0, 32 - 126 (ASCII)		
	49	1	00, 20 - 7E	Assignable Knob5 Name 10	0, 32 - 126 (ASCII)		
	4A	1	00, 20 - 7E	Assignable Knob5 Name 11	0, 32 - 126 (ASCII)		
	4B	1	00, 20 - 7E	Assignable Knob5 Name 12	0, 32 - 126 (ASCII)		
	4C	1	00, 20 - 7E	Assignable Knob5 Name 13	0, 32 - 126 (ASCII)		
	4D	1	00, 20 - 7E	Assignable Knob5 Name 14	0, 32 - 126 (ASCII)		
	4E	1	00, 20 - 7E	Assignable Knob5 Name 15	0, 32 - 126 (ASCII)		
	4F	1	00, 20 - 7E	Assignable Knob5 Name 16	0, 32 - 126 (ASCII)		
	50	1	00, 20 - 7E	Assignable Knob6 Name 1	0, 32 - 126 (ASCII)	Assign 6	
	51	1	00, 20 - 7E	Assignable Knob6 Name 2	0, 32 - 126 (ASCII)		
	52	1	00, 20 - 7E	Assignable Knob6 Name 3	0, 32 - 126 (ASCII)		
	53	1	00, 20 - 7E	Assignable Knob6 Name 4	0, 32 - 126 (ASCII)		
	54	1	00, 20 - 7E	Assignable Knob6 Name 5	0, 32 - 126 (ASCII)		
	55	1	00, 20 - 7E	Assignable Knob6 Name 6	0, 32 - 126 (ASCII)		
	56	1	00, 20 - 7E	Assignable Knob6 Name 7	0, 32 - 126 (ASCII)		
	57	1	00, 20 - 7E	Assignable Knob6 Name 8	0, 32 - 126 (ASCII)		
	58	1	00, 20 - 7E	Assignable Knob6 Name 9	0, 32 - 126 (ASCII)		
	59	1	00, 20 - 7E	Assignable Knob6 Name 10	0, 32 - 126 (ASCII)		
	5A	1	00, 20 - 7E	Assignable Knob6 Name 11	0, 32 - 126 (ASCII)		
	5B	1	00, 20 - 7E	Assignable Knob6 Name 12	0, 32 - 126 (ASCII)		
	5C	1	00, 20 - 7E	Assignable Knob6 Name 13	0, 32 - 126 (ASCII)		
	5D	1	00, 20 - 7E	Assignable Knob6 Name 14	0, 32 - 126 (ASCII)		
	5E	1	00, 20 - 7E	Assignable Knob6 Name 15	0, 32 - 126 (ASCII)		
	5F	1	00, 20 - 7E	Assignable Knob6 Name 16	0, 32 - 126 (ASCII)		
	60	1	00, 20 - 7E	Assignable Knob7 Name 1	0, 32 - 126 (ASCII)	Assign 7	
	61	1	00, 20 - 7E	Assignable Knob7 Name 2	0, 32 - 126 (ASCII)		
	62	1	00, 20 - 7E	Assignable Knob7 Name 3	0, 32 - 126 (ASCII)		
	63	1	00, 20 - 7E	Assignable Knob7 Name 4	0, 32 - 126 (ASCII)		
	64	1	00, 20 - 7E	Assignable Knob7 Name 5	0, 32 - 126 (ASCII)		
	65	1	00, 20 - 7E	Assignable Knob7 Name 6	0, 32 - 126 (ASCII)		
	66	1	00, 20 - 7E	Assignable Knob7 Name 7	0, 32 - 126 (ASCII)		
	67	1	00, 20 - 7E	Assignable Knob7 Name 8	0, 32 - 126 (ASCII)		
	68	1	00, 20 - 7E	Assignable Knob7 Name 9	0, 32 - 126 (ASCII)		
	69	1	00, 20 - 7E	Assignable Knob7 Name 10	0, 32 - 126 (ASCII)		
	6A	1	00, 20 - 7E	Assignable Knob7 Name 11	0, 32 - 126 (ASCII)		
	6B	1	00, 20 - 7E	Assignable Knob7 Name 12	0, 32 - 126 (ASCII)		
	6C	1	00, 20 - 7E	Assignable Knob7 Name 13	0, 32 - 126 (ASCII)		
	6D	1	00, 20 - 7E	Assignable Knob7 Name 14	0, 32 - 126 (ASCII)		
	6E	1	00, 20 - 7E	Assignable Knob7 Name 15	0, 32 - 126 (ASCII)		
	6F	1	00, 20 - 7E	Assignable Knob7 Name 16	0, 32 - 126 (ASCII)		

Address	Size	Data Range (HEX)	Parameter Name	Description	Default (HEX)	Notes
	70	1	00, 20 - 7E	Assignable Knob8 Name 1	0, 32 - 126 (ASCII)	Assign 8
	71	1	00, 20 - 7E	Assignable Knob8 Name 2	0, 32 - 126 (ASCII)	
	72	1	00, 20 - 7E	Assignable Knob8 Name 3	0, 32 - 126 (ASCII)	
	73	1	00, 20 - 7E	Assignable Knob8 Name 4	0, 32 - 126 (ASCII)	
	74	1	00, 20 - 7E	Assignable Knob8 Name 5	0, 32 - 126 (ASCII)	
	75	1	00, 20 - 7E	Assignable Knob8 Name 6	0, 32 - 126 (ASCII)	
	76	1	00, 20 - 7E	Assignable Knob8 Name 7	0, 32 - 126 (ASCII)	
	77	1	00, 20 - 7E	Assignable Knob8 Name 8	0, 32 - 126 (ASCII)	
	78	1	00, 20 - 7E	Assignable Knob8 Name 9	0, 32 - 126 (ASCII)	
	79	1	00, 20 - 7E	Assignable Knob8 Name 10	0, 32 - 126 (ASCII)	
	7A	1	00, 20 - 7E	Assignable Knob8 Name 11	0, 32 - 126 (ASCII)	
	7B	1	00, 20 - 7E	Assignable Knob8 Name 12	0, 32 - 126 (ASCII)	
	7C	1	00, 20 - 7E	Assignable Knob8 Name 13	0, 32 - 126 (ASCII)	
	7D	1	00, 20 - 7E	Assignable Knob8 Name 14	0, 32 - 126 (ASCII)	
	7E	1	00, 20 - 7E	Assignable Knob8 Name 15	0, 32 - 126 (ASCII)	
	7F	1	00, 20 - 7E	Assignable Knob8 Name 16	0, 32 - 126 (ASCII)	

TOTAL SIZE = 128 80 (HEX)

p = Part number
0 - F

Address	Size	Data Range (HEX)	Parameter Name	Description	Default (HEX)	Notes		
38	0p	00	1	00 - 27	Controller Set 1 Source	01		
		01	2	00 - 00 00 - 74	Controller Set 1 Destination	1st bit6-0 → bit13-7 2nd bit6-0 → bit6-0 0 - 115 (Refer to Controller Box Destination of Control List)	00 00	
		03	1	00 - 09	Controller Set 1 Curve Bank	0 = Preset, 1 = User, 2 = Library1...9 = Library8	00	
		04	1	00 - 1F	Controller Set 1 Curve Type	0 - 31 (0 - 17 when Bank is set to Preset)	00	
		05	1	00 - 7F	Controller Set 1 Curve Parameter 1	0 - 127	05	Fixed to "0" except when Bank is set to Preset
		06	1	00 - 7F	Controller Set 1 Curve Parameter 2	0 - 127	00	Fixed to "0" except when Bank is set to Preset
		07	1	00 - 01	Controller Set 1 Curve Polarity	Uni, Bi	00	
		08	1	00 - 7F	Controller Set 1 Curve Ratio	-64 - +63	60	
		09	1	00 - 27	Controller Set 2 Source	0 - 39 (Refer to Controller Box Source of Control List)	01	
		0A	2	00 - 00 00 - 74	Controller Set 2 Destination	1st bit6-0 → bit13-7 2nd bit6-0 → bit6-0 0 - 115 (Refer to Controller Box Destination of Control List)	00 00	
		0C	1	00 - 09	Controller Set 2 Curve Bank	0 = Preset, 1 = User, 2 = Library1...9 = Library8	00	
		0D	1	00 - 1F	Controller Set 2 Curve Type	0 - 31 (0 - 17 when Bank is set to Preset)	00	
		0E	1	00 - 7F	Controller Set 2 Curve Parameter 1	0 - 127	05	Fixed to "0" except when Bank is set to Preset
		0F	1	00 - 7F	Controller Set 2 Curve Parameter 2	0 - 127	00	Fixed to "0" except when Bank is set to Preset
		10	1	00 - 01	Controller Set 2 Curve Polarity	Uni, Bi	00	
		11	1	00 - 7F	Controller Set 2 Curve Ratio	-64 - +63	60	
		12	1	00 - 27	Controller Set 3 Source	0 - 39 (Refer to Controller Box Source of Control List)	01	
		13	2	00 - 00 00 - 74	Controller Set 3 Destination	1st bit6-0 → bit13-7 2nd bit6-0 → bit6-0 0 - 115 (Refer to Controller Box Destination of Control List)	00 00	
		15	1	00 - 09	Controller Set 3 Curve Bank	0 = Preset, 1 = User, 2 = Library1...9 = Library8	00	
		16	1	00 - 1F	Controller Set 3 Curve Type	0 - 31 (0 - 17 when Bank is set to Preset)	00	
		17	1	00 - 7F	Controller Set 3 Curve Parameter 1	0 - 127	05	Fixed to "0" except when Bank is set to Preset
		18	1	00 - 7F	Controller Set 3 Curve Parameter 2	0 - 127	00	Fixed to "0" except when Bank is set to Preset
		19	1	00 - 01	Controller Set 3 Curve Polarity	Uni, Bi	00	
		1A	1	00 - 7F	Controller Set 3 Curve Ratio	-64 - +63	60	

Address	Size	Data Range (HEX)	Parameter Name	Description	Default (HEX)	Notes
1B	1	00-27	Controller Set 4 Curve Source	0-39 (Refer to Controller Box Source of Control List)	01	
1C	2	00-00 00-74	Controller Set 4 Destination	1st bit6-0 → bit13-7 2nd bit6-0 → bit6-0 0-115 (Refer to Controller Box Destination of Control List)	00 00	
1E	1	00-09	Controller Set 4 Curve Bank	0 = Preset, 1 = User, 2 = Library1...9 = Library8	00	
1F	1	00-1F	Controller Set 4 Curve Type	0-31 (0-17 when Bank is set to Preset)	00	
20	1	00-7F	Controller Set 4 Curve Parameter 1	0-127	05	Fixed to "0" except when Bank is set to Preset
21	1	00-7F	Controller Set 4 Curve Parameter 2	0-127	00	Fixed to "0" except when Bank is set to Preset
22	1	00-01	Controller Set 4 Curve Polarity	Uni, Bi	00	
23	1	00-7F	Controller Set 4 Curve Ratio	-64 - +63	60	
24	1	00-27	Controller Set 5 Source	0-39 (Refer to Controller Box Source of Control List)	01	
25	2	00-00 00-74	Controller Set 5 Destination	1st bit6-0 → bit13-7 2nd bit6-0 → bit6-0 0-115 (Refer to Controller Box Destination of Control List)	00 00	
27	1	00-09	Controller Set 5 Curve Bank	0 = Preset, 1 = User, 2 = Library1...9 = Library8	00	
28	1	00-1F	Controller Set 5 Curve Type	0-31 (0-17 when Bank is set to Preset)	00	
29	1	00-7F	Controller Set 5 Curve Parameter 1	0-127	05	Fixed to "0" except when Bank is set to Preset
2A	1	00-7F	Controller Set 5 Curve Parameter 2	0-127	00	Fixed to "0" except when Bank is set to Preset
2B	1	00-01	Controller Set 5 Curve Polarity	Uni, Bi	00	
2C	1	00-7F	Controller Set 5 Curve Ratio	-64 - +63	60	
2D	1	00-27	Controller Set 6 Source	0-39 (Refer to Controller Box Source of Control List)	01	
2E	2	00-00 00-74	Controller Set 6 Destination	1st bit6-0 → bit13-7 2nd bit6-0 → bit6-0 0-115 (Refer to Controller Box Destination of Control List)	00 00	
30	1	00-09	Controller Set 6 Curve Bank	0 = Preset, 1 = User, 2 = Library1...9 = Library8	00	
31	1	00-1F	Controller Set 6 Curve Type	0-31 (0-17 when Bank is set to Preset)	00	
32	1	00-7F	Controller Set 6 Curve Parameter 1	0-127	05	Fixed to "0" except when Bank is set to Preset
33	1	00-7F	Controller Set 6 Curve Parameter 2	0-127	00	Fixed to "0" except when Bank is set to Preset
34	1	00-01	Controller Set 6 Curve Polarity	Uni, Bi	00	
35	1	00-7F	Controller Set 6 Curve Ratio	-64 - +63	60	
36	1	00-27	Controller Set 7 Source	0-39 (Refer to Controller Box Source of Control List)	01	
37	2	00-00 00-74	Controller Set 7 Destination	1st bit6-0 → bit13-7 2nd bit6-0 → bit6-0 0-115 (Refer to Controller Box Destination of Control List)	00 00	
39	1	00-09	Controller Set 7 Curve Bank	0 = Preset, 1 = User, 2 = Library1...9 = Library8	00	
3A	1	00-1F	Controller Set 7 Curve Type	0-31 (0-17 when Bank is set to Preset)	00	
3B	1	00-7F	Controller Set 7 Curve Parameter 1	0-127	05	Fixed to "0" except when Bank is set to Preset
3C	1	00-7F	Controller Set 7 Curve Parameter 2	0-127	00	Fixed to "0" except when Bank is set to Preset
3D	1	00-01	Controller Set 7 Curve Polarity	Uni, Bi	00	
3E	1	00-7F	Controller Set 7 Curve Ratio	-64 - +63	60	
3F	1	00-27	Controller Set 8 Source	0-39 (Refer to Controller Box Source of Control List)	01	
40	2	00-00 00-74	Controller Set 8 Destination	1st bit6-0 → bit13-7 2nd bit6-0 → bit6-0 0-115 (Refer to Controller Box Destination of Control List)	00 00	

Address	Size	Data Range (HEX)	Parameter Name	Description	Default (HEX)	Notes
42	1	00-09	Controller Set 8 Curve Bank	0 = Preset, 1 = User, 2 = Library1...9 = Library8	00	
43	1	00-1F	Controller Set 8 Curve Type	0-31 (0-17 when Bank is set to Preset)	00	
44	1	00-7F	Controller Set 8 Curve Parameter 1	0-127	05	Fixed to "0" except when Bank is set to Preset
45	1	00-7F	Controller Set 8 Curve Parameter 2	0-127	00	Fixed to "0" except when Bank is set to Preset
46	1	00-01	Controller Set 8 Curve Polarity	Uni, Bi	00	
47	1	00-7F	Controller Set 8 Curve Ratio	-64 - +63	60	
48	1	00-27	Controller Set 9 Source	0-39 (Refer to Controller Box Source of Control List)	01	
49	2	00-00 00-74	Controller Set 9 Destination	1st bit6-0 → bit13-7 2nd bit6-0 → bit6-0 0-115 (Refer to Controller Box Destination of Control List)	00 00	
4B	1	00-09	Controller Set 9 Curve Bank	0 = Preset, 1 = User, 2 = Library1...9 = Library8	00	
4C	1	00-1F	Controller Set 9 Curve Type	0-31 (0-17 when Bank is set to Preset)	00	
4D	1	00-7F	Controller Set 9 Curve Parameter 1	0-127	05	Fixed to "0" except when Bank is set to Preset
4E	1	00-7F	Controller Set 9 Curve Parameter 2	0-127	00	Fixed to "0" except when Bank is set to Preset
4F	1	00-01	Controller Set 9 Curve Polarity	Uni, Bi	00	
50	1	00-7F	Controller Set 9 Curve Ratio	-64 - +63	60	
51	1	00-27	Controller Set 10 Source	0-39 (Refer to Controller Box Source of Control List)	01	
52	2	00-00 00-74	Controller Set 10 Destination	1st bit6-0 → bit13-7 2nd bit6-0 → bit6-0 0-115 (Refer to Controller Box Destination of Control List)	00 00	
54	1	00-09	Controller Set 10 Curve Bank	0 = Preset, 1 = User, 2 = Library1...9 = Library8	00	
55	1	00-1F	Controller Set 10 Curve Type	0-31 (0-17 when Bank is set to Preset)	00	
56	1	00-7F	Controller Set 10 Curve Parameter 1	0-127	05	Fixed to "0" except when Bank is set to Preset
57	1	00-7F	Controller Set 10 Curve Parameter 2	0-127	00	Fixed to "0" except when Bank is set to Preset
58	1	00-01	Controller Set 10 Curve Polarity	Uni, Bi	00	
59	1	00-7F	Controller Set 10 Curve Ratio	-64 - +63	60	
5A	1	00-27	Controller Set 11 Source	0-39 (Refer to Controller Box Source of Control List)	01	
5B	2	00-00 00-74	Controller Set 11 Destination	1st bit6-0 → bit13-7 2nd bit6-0 → bit6-0 0-115 (Refer to Controller Box Destination of Control List)	00 00	
5D	1	00-09	Controller Set 11 Curve Bank	0 = Preset, 1 = User, 2 = Library1...9 = Library8	00	
5E	1	00-1F	Controller Set 11 Curve Type	0-31 (0-17 when Bank is set to Preset)	00	
5F	1	00-7F	Controller Set 11 Curve Parameter 1	0-127	05	Fixed to "0" except when Bank is set to Preset
60	1	00-7F	Controller Set 11 Curve Parameter 2	0-127	00	Fixed to "0" except when Bank is set to Preset
61	1	00-01	Controller Set 11 Curve Polarity	Uni, Bi	00	
62	1	00-7F	Controller Set 11 Curve Ratio	-64 - +63	60	
63	1	00-27	Controller Set 12 Source	0-39 (Refer to Controller Box Source of Control List)	01	
64	2	00-00 00-74	Controller Set 12 Destination	1st bit6-0 → bit13-7 2nd bit6-0 → bit6-0 0-115 (Refer to Controller Box Destination of Control List)	00 00	
66	1	00-09	Controller Set 12 Curve Bank	0 = Preset, 1 = User, 2 = Library1...9 = Library8	00	
67	1	00-1F	Controller Set 12 Curve Type	0-31 (0-17 when Bank is set to Preset)	00	
68	1	00-7F	Controller Set 12 Curve Parameter 1	0-127	05	Fixed to "0" except when Bank is set to Preset

Address	Size	Data Range (HEX)	Parameter Name	Description	Default (HEX)	Notes
69	1	00 - 7F	Controller Set 12 Curve Parameter 2	0 - 127	00	Fixed to "0" except when Bank is set to Preset
6A	1	00 - 01	Controller Set 12 Curve Polarity	Uni, Bi	00	
6B	1	00 - 7F	Controller Set 12 Curve Ratio	-64 - +63	60	
6C	1	00 - 27	Controller Set 13 Source	0 - 39 (Refer to Controller Box Source of Control List)	01	
6D	2	00 - 00 00 - 74	Controller Set 13 Destination	1st bit6-0 → bit13-7 2nd bit6-0 → bit6-0 0 - 115 (Refer to Controller Box Destination of Control List)	00 00	
6F	1	00 - 09	Controller Set 13 Curve Bank	0 = Preset, 1 = User, 2 = Library1...9 = Library8	00	
70	1	00 - 1F	Controller Set 13 Curve Type	0 - 31 (0 - 17 when Bank is set to Preset)	00	
71	1	00 - 7F	Controller Set 13 Curve Parameter 1	0 - 127	05	Fixed to "0" except when Bank is set to Preset
72	1	00 - 7F	Controller Set 13 Curve Parameter 2	0 - 127	00	Fixed to "0" except when Bank is set to Preset
73	1	00 - 01	Controller Set 13 Curve Polarity	Uni, Bi	00	
74	1	00 - 7F	Controller Set 13 Curve Ratio	-64 - +63	60	

TOTAL SIZE = 117 75 (HEX)

p = Part number
0 - F

Address	Size	Range (HEX)	Parameter Name	Description	Default (HEX)	Notes	
	18	1	00 - 7F	Controller Set 16 Curve Parameter 2	0 - 127	00	Fixed to "0" except when Bank is set to Preset
	19	1	00 - 01	Controller Set 16 Curve Polarity	Uni, Bi	00	
	1A	1	00 - 7F	Controller Set 16 Curve Ratio	-64 - +63	60	

TOTAL SIZE = 27 1B (HEX)

p = Part number
0 - F

Address	Size	Range (HEX)	Parameter Name	Description	Default (HEX)	Notes		
38	1p	00	1	00 - 27	Controller Set 14 Source	0 - 39 (Refer to Controller Box Source of Control List)	01	
		01	2	00 - 00 00 - 74	Controller Set 14 Destination	1st bit6-0 → bit13-7 2nd bit6-0 → bit6-0 0 - 115 (Refer to Controller Box Destination of Control List)	00 00	
		03	1	00 - 09	Controller Set 14 Curve Bank	0 = Preset, 1 = User, 2 = Library1...9 = Library8	00	
		04	1	00 - 1F	Controller Set 14 Curve Type	0 - 31 (0 - 17 when Bank is set to Preset)	00	
		05	1	00 - 7F	Controller Set 14 Curve Parameter 1	0 - 127	05	Fixed to "0" except when Bank is set to Preset
		06	1	00 - 7F	Controller Set 14 Curve Parameter 2	0 - 127	00	Fixed to "0" except when Bank is set to Preset
		07	1	00 - 01	Controller Set 14 Curve Polarity	Uni, Bi	00	
		08	1	00 - 7F	Controller Set 14 Curve Ratio	-64 - +63	60	
		09	1	00 - 27	Controller Set 15 Source	0 - 39 (Refer to Controller Box Source of Control List)	01	
		0A	2	00 - 00 00 - 74	Controller Set 15 Destination	1st bit6-0 → bit13-7 2nd bit6-0 → bit6-0 0 - 115 (Refer to Controller Box Destination of Control List)	00 00	
		0C	1	00 - 09	Controller Set 15 Curve Bank	0 = Preset, 1 = User, 2 = Library1...9 = Library8	00	
		0D	1	00 - 1F	Controller Set 15 Curve Type	0 - 31 (0 - 17 when Bank is set to Preset)	00	
		0E	1	00 - 7F	Controller Set 15 Curve Parameter 1	0 - 127	05	Fixed to "0" except when Bank is set to Preset
		0F	1	00 - 7F	Controller Set 15 Curve Parameter 2	0 - 127	00	Fixed to "0" except when Bank is set to Preset
		10	1	00 - 01	Controller Set 15 Curve Polarity	Uni, Bi	00	
		11	1	00 - 7F	Controller Set 15 Curve Ratio	-64 - +63	60	
		12	1	00 - 27	Controller Set 16 Source	0 - 39 (Refer to Controller Box Source of Control List)	01	
		13	2	00 - 00 00 - 74	Controller Set 16 Destination	1st bit6-0 → bit13-7 2nd bit6-0 → bit6-0 0 - 115 (Refer to Controller Box Destination of Control List)	00 00	
		15	1	00 - 09	Controller Set 16 Curve Bank	0 = Preset, 1 = User, 2 = Library1...9 = Library8	00	
		16	1	00 - 1F	Controller Set 16 Curve Type	0 - 31 (0 - 17 when Bank is set to Preset)	00	
		17	1	00 - 7F	Controller Set 16 Curve Parameter 1	0 - 127	05	Fixed to "0" except when Bank is set to Preset

MIDI PARAMETER CHANGE TABLE (NORMAL PART ELEMENT)

Address	Size	Data Range (HEX)	Parameter Name	Description	Default (HEX)	Notes		
41	ep	00	1	00-01	Element Switch	Off, On	01 (EL1 only)	
		01	1	00-09	Wave Select	0 = Preset, 1 = User, 2-9 = Library1-8	00	
		02	1	00-07	Element Group Number	1-8	00	
		03	2	00-1F 00-7F	Wave Number	1-6347 (User, Library: 1-2048) 1st bit6-0 → bit13-7 2nd bit6-0 → bit6-0	00 01	
		05	1	01	reserved			
		06	1	01	reserved			
		07	1	00	reserved			
		08	1	01-7F	Element Pan	L63-C-R63	40	
		09	1	00-7F	Random Pan Depth	0-127	00	
		0A	1	00-7F	Alternate Pan Depth	L64-C-R63	40	
		0B	1	00-7F	Scaling Pan Depth	-64-+63	40	
		0C	1	00-07	XA Control	Normal, Legato, Key Off, Cycle, Random, A.SW Off, A.SW1 On, A.SW2 On	00	
		0D	1	00-7F	Note Limit Low	C-2-G8	00	
		0E	1	00-7F	Note Limit High	C-2-G8	7F	
		0F	1	01-7F	Velocity Limit Low	1-127	01	
		10	1	01-7F	Velocity Limit High	1-127	7F	
		11	1	00-7F	Velocity Cross Fade	0-127	00	
		12	1	00-7F	Key On Delay Time Length	0-127	00	This is available only when Tempo Sync is set to Off.
		13	1	00-01	Key On Delay Tempo Sync Switch	Off, On	00	
		14	1		reserved			
		15	1		reserved			
		16	1		reserved			
		17	1	00-02	Element Connection Switch	Thru, InsA, InsB	01	
		18	1	00	(reserved) Output Select	0=stereo out		Fixed to "stereo out"
		19	5	00-00 00-00 00-03 00-7F 00-7F	Controller Set 1-16 Element Switch	1st reserved 2nd reserved 3rd bit1-0 → bit15-14 4th bit6-0 → bit13-7 5th bit6-0 → bit6-0 0-0000FFFFh, bit0: Box1-bit15; Box16	00 00 03 7F 7F	
		1E	5		reserved			
		23	2	00 00-07	Part LFO Element Switch	1st bit6-0: reserved 2nd bit6-3: reserved 2nd bit2: off, on box3 2nd bit1: off, on box2 2nd bit0: off, on box1	00 07	
		25	1	05-15	Key On Delay Note Length	5-21 (16th, 8th/3, 16th., 8th, 4th/3, 8th., 4th, 2th/3, 4th., 2nd, Whole/3, 2nd., 4thX4, 4thX5, 4thX6, 4thX7, 4thX8)	0B	This is available only when Tempo Sync is set to On.
		26	1	00-01	Half Damper Switch	Off, On	00	
		27	1		reserved			
		28	1	00-7F	Element Level	0-127	7F	
		29	1	00-7F	Level Velocity Sensitivity	-64-+63	40	
		2A	1	00-7F	Level Velocity Offset	0-127	?	
		2B	1	00-04	Level Sensitivity Key Curve	00-04 □□□□□	03	
		2C	1		reserved			
		2D	1	00-7F	AEG Attack Time	0-127	00	
		2E	1	00-7F	AEG Decay 1 Time	0-127	40	
		2F	1	00-7F	AEG Decay 2 Time	0-127	40	
		30	1	00-7F	Half Damper Time	0-127	7F	
		31	1	00-7F	AEG Release Time	0-127	32	
		32	1	00-7F	AEG Initial Level	0-127	00	
		33	1	00-7F	AEG Attack Level	0-127	7F	
		34	1	00-7F	AEG Decay 1 Level	0-127	7F	
		35	1	00-7F	AEG Decay 2 Level	0-127	7F	
		36	1		reserved			
		37	1	00-04	AEG Time Velocity Segment	Attack, Atk+Dcy, Decay, Atk+Rls, All	04	
		38	1	00-7F	AEG Time Velocity Sensitivity	-64-+63	40	
		39	1	00-7F	AEG Time Key Follow Sensitivity	-64-+63	40	
		3A	1	00-7F	AEG Time Key Follow Center Note	C-2-G8	18	
		3B	1	00-7C	Level Scaling Break Point 1	C-2-E8	24	BP1 < BP2 < BP3 < BP4
		3C	1	01-7D	Level Scaling Break Point 2	C#-2-F8	30	BP1 < BP2 < BP3 < BP4
		3D	1	02-7E	Level Scaling Break Point 3	D-2-F#8	3C	BP1 < BP2 < BP3 < BP4
		3E	1	03-7F	Level Scaling Break Point 4	D#-2-G8	48	BP1 < BP2 < BP3 < BP4

Address	Size	Data Range (HEX)	Parameter Name	Description	Default (HEX)	Notes	
		3F	2	00-01 00-7F	Level Scaling Offset 1	-128-+127 1st bit6-0 → bit13-7 2nd bit6-0 → bit6-0	01 00
		41	2	00-01 00-7F	Level Scaling Offset 2	:	01 00
		43	2	00-01 00-7F	Level Scaling Offset 3	:	01 00
		45	2	00-01 00-7F	Level Scaling Offset 4	:	01 00
		47	1	00-7F	Level Key Follow Sensitivity	-64-+63	40
		48	1	00-7F	AEG Time Key Follow Sensitivity Release Adjustment	0-127	40
		49	1	10-70	Coarse Tune	-48-+48	40
		4A	1	00-7F	Fine Tune	-64-+63	40
		4B	1	00-7F	Pitch Velocity Sensitivity	-64-+63	40
		4C	1		reserved		00
		4D	1	00-7F	Random Pitch Depth	0-127	00
		4E	1	00-7F	Pitch Key Follow Sensitivity	-200%-+200%	60
		4F	1	00-7F	Pitch Key Follow Sensitivity Center Note	C-2-G8	3C
		50	1	00-7F	Fine Tune Key Follow Scaling Sensitivity	-64-+63	40
		51	1	00-7F	PEG Hold Time	0-127	00
		52	1	00-7F	PEG Attack Time	0-127	28
		53	1	00-7F	PEG Decay 1 Time	0-127	40
		54	1	00-7F	PEG Decay 2 Time	0-127	40
		55	1	00-7F	PEG Release Time	0-127	40
		56	2	00-01 00-7F	PEG Hold Level	-128-+127 (-4800-+4800 [cent]) 1st bit6-0 → bit13-7 2nd bit6-0 → bit6-0	01 00
		58	2	00-01 00-7F	PEG Attack Level	:	01 00
		5A	2	00-01 00-7F	PEG Decay 1 Level	:	01 00
		5C	2	00-01 00-7F	PEG Decay 2 Level	:	01 00
		5E	2	00-01 00-7F	PEG Release Level	:	01 00
		60	1	00-7F	PEG Depth	-64-+63	54
		61	1	00-04	PEG Time Velocity Sensitivity Segment	Attack, Atk+Dcy, Decay, Atk+Rls, All	04
		62	1	00-7F	PEG Time Velocity Sensitivity	-64-+63	40
		63	1	00-7F	PEG Depth Velocity Sensitivity	-64-+63	40
		64	1	00-04	PEG Depth Velocity Sensitivity Curve	00-04 □□□□□	02
		65	1	00-7F	PEG Time Key Follow Sensitivity	-64-+63	40
		66	1	00-7F	PEG Time Key Follow Sensitivity Center Note	C-2-G8	3C

TOTAL SIZE = 103 67 (HEX)

p = Part number
0-Fe = Element number
0-7

Address	Size	Data Range (HEX)	Parameter Name	Description	Default (HEX)	Notes		
42	ep	00	1	00 - 15	Filter Type	LPF24D, LPF24A, LPF18, LPF18s, LPF12+HPF12, LPF6+HPF12, HPF24D, HPF12, BPF12D, BPFw, BPF6, BEF12, BEF6, DualLPF, DualHPF, DualBPF, DualBEF, LPF12+BPF6, Thru	04	
		01	2	00 - 01 00 - 7F	Filter Cutoff Frequency	0 - 255 1st bit6-0 → bit13-7 2nd bit6-0 → bit6-0	01 20	
		03	1	00 - 7F	Filter Cutoff Velocity Sensitivity	-64 - +63	40	
		04	1		reserved			
		05	1	00 - 7F	Filter Resonance/Width	0 - 127	00	Not available for LPF6 and Thru
		06	1	00 - 7F	Filter Resonance Velocity Sensitivity	-64 - +63	40	
		07	2	00 - 01 00 - 7F	HPF Cutoff Frequency	0 - 255 1st bit6-0 → bit13-7 2nd bit6-0 → bit6-0	00 00	
		09	1		reserved			
		0A	2	00 - 01 00 - 7F	Distance	-128 - +127 1st bit6-0 → bit13-7 2nd bit6-0 → bit6-0	01 00	This is available when Filter Type is set to Dual.
		0C	2	00 - 01 00 - 7F	Filter Gain	0 - 255 1st bit6-0 → bit13-7 2nd bit6-0 → bit6-0	01 66	
		0E	1	00 - 7F	FEG Hold Time	0 - 127	00	
		0F	1	00 - 7F	FEG Attack Time	0 - 127	00	
		10	1	00 - 7F	FEG Decay 1 Time	0 - 127	40	
		11	1	00 - 7F	FEG Decay 2 Time	0 - 127	40	
		12	1	00 - 7F	FEG Release Time	0 - 127	50	
		13	2	00 - 01 00 - 7F	FEG Hold Level	-128 - +127 (-9600 - +9600 [cent]) 1st bit6-0 → bit13-7 2nd bit6-0 → bit6-0	01 00	
		15	2	00 - 01 00 - 7F	FEG Attack Level	:	01 7F	
		17	2	00 - 01 00 - 7F	FEG Decay 1 Level	:	01 7F	
		19	2	00 - 01 00 - 7F	FEG Decay 2 Level	:	01 7F	
		1B	2	00 - 01 00 - 7F	FEG Release Level	:	01 00	
		1D	1	00 - 7F	FEG Depth	-64 - +63	68	
		1E	1	00 - 04	FEG Time Velocity Sensitivity Segment	Attack, Atk+Dcy, Decay, Atk+Ris, All	04	
		1F	1	00 - 7F	FEG Time Velocity Sensitivity	-64 - +63	40	
		20	1	00 - 7F	FEG Depth Velocity Sensitivity	-64 - +63	40	
		21	1	00 - 04	FEG Depth Velocity Sensitivity Curve	00 - 04	02	
		22	1	00 - 7F	FEG Time Key Follow Sensitivity	-64 - +63	40	
		23	1	00 - 7F	FEG Time Key Follow Sensitivity Center Note	C-2 - G8	18	
		24	1	00 - 7C	Filter Cutoff Scaling Break Point 1	C -2 - E8	24	BP1 < BP2 < BP3 < BP4
		25	1	01 - 7D	Filter Cutoff Scaling Break Point 2	C#-2 - F8	30	BP1 < BP2 < BP3 < BP4
		26	1	02 - 7E	Filter Cutoff Scaling Break Point 3	D -2 - F#8	3C	BP1 < BP2 < BP3 < BP4
		27	1	03 - 7F	Filter Cutoff Scaling Break Point 4	D#-2 - G8	48	BP1 < BP2 < BP3 < BP4
		28	2	00 - 01 00 - 7F	Filter Cutoff Scaling Offset 1	-128 - +127 1st bit6-0 → bit13-7 2nd bit6-0 → bit6-0	01 00	
		2A	2	00 - 01 00 - 7F	Filter Cutoff Scaling Offset 2	:	01 00	
		2C	2	00 - 01 00 - 7F	Filter Cutoff Scaling Offset 3	:	01 00	
		2E	2	00 - 01 00 - 7F	Filter Cutoff Scaling Offset 4	:	01 00	
		30	1	00 - 7F	Filter Cutoff Key Follow Sensitivity	-200% - +200%	4A	
		31	1	00 - 7F	HPF Cutoff Key Follow Sensitivity	-200% - +200%	40	
		32	1	00 - 05	EQ Type	2-band, PEQ, Boost6, Boost12, Boost18, Thru	00	
		33	1	00 - 1F	EQ Q	0.7 - 10.3	00	This is available only when PEQ is selected for EQ Type.
		34	2	00 - 01 00 - 7F	EQ 1 Frequency	50.1 - 2.00k (2 Band) 139.7 - 12.9k (PEQ) 1st bit6-0 → bit13-7 2nd bit6-0 → bit6-0	00 36	This is available only when 2-band or PEQ is selected for EQ Type.

Address	Size	Data Range (HEX)	Parameter Name	Description	Default (HEX)	Notes		
		36	1	20 - 60	EQ 1 Gain	-12.00dB - +12.00dB	40	
		37	2	01 03 - 71	EQ 2 Frequency	503.8 - 10.1k 1st bit6-0 → bit13-7 2nd bit6-0 → bit6-0	01 67	This is available only when 2-band is selected for EQ Type.
		39	1	20 - 60	EQ 2 Gain	-12.00dB - +12.00dB	40	
		3A	1	00 - 02	LFO Wave	Saw, Triangle, Square	01	
		3B	1	00 - 01	LFO Key On Reset	Off, On	01	
		3C	1	00 - 7F	LFO Delay Time	0 - 127	00	
		3D	1	00 - 3F	LFO Speed	0 - 63	26	
		3E	1	00 - 7F	LFO Amplitude Modulation Depth	0 - 127	00	
		3F	1	00 - 7F	LFO Pitch Modulation Depth	0 - 127	00	
		40	1	00 - 7F	LFO Filter Modulation Depth	0 - 127	00	
		41	1	00 - 7F	LFO Fade In Time	0 - 127	00	
		42	1	00 - 05	Part LFO Phase Offset	+0, +90, +120, +180, +240, +270	00	
		43	1	00 - 7F	Part LFO Destination 1 Depth Ratio	0 - 127	7F	
		44	1	00 - 7F	Part LFO Destination 2 Depth Ratio	0 - 127	7F	
		45	1	00 - 7F	Part LFO Destination 3 Depth Ratio	0 - 127	7F	

TOTAL SIZE = 70 46 (HEX)

p = Part number
0 - Fe = Element number
0 - 7

MIDI PARAMETER CHANGE TABLE (DRUM VOICE KEY)

Address	Size	Data Range (HEX)	Parameter Name	Description	Default (HEX)	Notes
5p	kk	00 1	00 - 01	Drum Key Switch	Off, On	01
		01 1	00 - 09	Wave Select	0=Preset, 1=User, 2-9=Library1-8	00
		02 1		reserved		
		03 1	00 - 01	Receive Note Off	Off, On	00
		04 1	00 - 01	Key Assign Mode	Single, Multi	01
		05 1	00 - 7F	Alternate Group	0:Off, 1-127	00
		06 2	00 - 1F 00 - 7F	Wave Number	1-6347 (User, Library: 1-2048) 1st bit6-0 → bit13-7 2nd bit6-0 → bit6-0	00 01
		08 1	01 - 7F	Pan	L63 - C - R63	40
		09 1	00 - 7F	Random Pan Depth	0 - 127	00
		0A 1	00 - 7F	Alternate Pan Depth	L64 - C - R63	40
		0B 1	00 - 7F	Drum Key Reverb Send Level	0 - 127	5A
		0C 1	00 - 7F	Drum Key Variation Send Level	0 - 127	00
		0D 1		reserved		
		0E 1	00 - 02	Drum Key Connection Switch	Thru, InsA, InsB	00
		0F 1	00 - 5F	Drum Key Output Select	0: MainL&R, 8: AsgnL&R, 9-23: USB1&2...USB29&30, 64-95: AsgnL, AsgnR, USB1...USB30	00
		10 1	00 - 7F	Drum Key Level	0 - 127	7F
		11 1	00 - 7F	Level Velocity Sensitivity	-64 - +63	40
		12 1		reserved		
		13 1	00 - 7F	AEG Attack Time	0 - 127	00
		14 1	00 - 7F	AEG Decay 1 Time	0 - 127	60
		15 1	00 - 7F	AEG Decay 2 Time	0 - 126, Hold	50
		16 1		reserved		
		17 1		reserved		
		18 1		reserved		
		19 1	00 - 7F	AEG Decay 1 Level	0 - 127	7F
		1A 1		reserved		
		1B 1		reserved		
		1C 1	10 - 70	Coarse Tune	-48 - +48	40
		1D 1	00 - 7F	Fine Tune	-64 - +63	40
		1E 1	00 - 7F	Pitch Velocity Sensitivity	-64 - +63	40
		1F 1		reserved		
		20 2	00 - 01 00 - 7F	LPF Cutoff Frequency	0 - 255 1st bit6-0 → bit13-7 2nd bit6-0 → bit6-0	01 7F
		22 1	00 - 7F	LPF Cutoff Velocity Sensitivity	-64 - +63	40
		23 1	20 - 60	LPF Resonance	0 - 127	00
		24 1		reserved		
		25 2	00 - 01 00 - 7F	HPF Cutoff Frequency	0 - 255 1st bit6-0 → bit13-7 2nd bit6-0 → bit6-0	00 00
		27 1	00 - 05	EQ Type	2 Band, P.EQ, Boost6, Boost12, Boost18, Thru	00
		28 1	00 - 1F	EQ Q	0.7 - 10.3	00
		29 2	00 - 01 00 - 7F	EQ 1 Frequency	50.1 - 2.00k (2 Band) 139.7 - 12.9k (P.EQ) 1st bit6-0 → bit13-7 2nd bit6-0 → bit6-0	00 36
		2B 1	20 - 60	EQ 1 Gain	-12.00dB - +12.00dB	40
		2C 2	01 03 - 71	EQ 2 Frequency	503.8 - 10.1k 1st bit6-0 → bit13-7 2nd bit6-0 → bit6-0	01 67
		2E 1	20 - 60	EQ 2 Gain	-12.00dB - +12.00dB	40

TOTAL SIZE = 47 2F (HEX)

p = Part number
00 - 0F

kk = Key number
00 - 48

MIDI PARAMETER CHANGE TABLE (FM PART COMMON)

Address	Size	Data Range (HEX)	Parameter Name	Description	Default (HEX)	Notes
48	0p	00 1	00 - 7F	Random Pan Depth	0 - 127	00
		01 1	00 - 7F	Alternate Pan Depth	L64 - C - R63	40
		02 1	00 - 7F	Scaling Pan Depth	-64 - +63	40
		03 1	00 - 7F	Key On Delay Time Length	0 - 127	00
		04 1	00 - 01	Key On Delay Tempo Sync Switch	Off, On	00
		05 1	05 - 15	Key On Delay Note Length	5 - 21 (16th, 8th/3, 16th., 8th, 4th/3, 8th., 4th, 2th/3, 4th., 2nd, Whole/3, 2nd., 4thX4, 4thX5, 4thX6, 4thX7, 4thX8)	0E
		06 1	00 - 7F	Pitch Velocity Sensitivity	-64 - +63	40
		07 1	00 - 7F	Random Pitch Depth	0 - 127	00
		08 1	00 - 7F	Pitch Key Follow Sensitivity	-200% - +200%	60
		09 1	00 - 7F	Pitch Key Follow Sensitivity Center Note	C-2 - G8	3C
		0A 1		reserved		
		0B 1	00 - 15	Filter Type	LPF24D, LPF24A, LPF18, LPF18s, LPF12+HPF12, LPF6+HPF12, HPF24D, HPF12, BPF12D, BPFw, BPF6, BEF12, BEF6, DualLPF, DualHPF, DualBPF, DualBEF, LPF12+BPF6, Thru	15
		0C 2	00 - 01 00 - 7F	Filter Cutoff Frequency	0 - 255 1st bit6-0 → bit13-7 2nd bit6-0 → bit6-0	01 7F
		0E 1	00 - 7F	Filter Cutoff Velocity Sensitivity	-64 - +63	40
		0F 1	00 - 7F	Filter Resonance/Width	0 - 127	0A
		10 1	00 - 7F	Filter Resonance Velocity Sensitivity	-64 - +63	40
		11 2	00 - 01 00 - 7F	HPF Cutoff Frequency	0 - 255 1st bit6-0 → bit13-7 2nd bit6-0 → bit6-0	00 00
		13 2	00 - 01 00 - 7F	Distance	-128 - +127 1st bit6-0 → bit13-7 2nd bit6-0 → bit6-0	01 00
		15 2	00 - 01 00 - 7F	Filter Gain	0 - 255 1st bit6-0 → bit13-7 2nd bit6-0 → bit6-0	01 7F
		17 1	00 - 7F	FEG Hold Time	0 - 127	00
		18 1	00 - 7F	FEG Attack Time	0 - 127	00
		19 1	00 - 7F	FEG Decay 1 Time	0 - 127	00
		1A 1	00 - 7F	FEG Decay 2 Time	0 - 127	00
		1B 1	00 - 7F	FEG Release Time	0 - 127	00
		1C 2	00 - 01 00 - 7F	FEG Hold Level	-128 - +127 (-9600 - +9600 [cent]) 1st bit6-0 → bit13-7 2nd bit6-0 → bit6-0	01 00
		1E 2	00 - 01 00 - 7F	FEG Attack Level	:	01 00
		20 2	00 - 01 00 - 7F	FEG Decay 1 Level	:	01 00
		22 2	00 - 01 00 - 7F	FEG Decay 2 Level	:	01 00
		24 2	00 - 01 00 - 7F	FEG Release Level	:	01 00
		26 1	00 - 7F	FEG Depth	-64 - +63	68
		27 1	00 - 04	FEG Time Velocity Sensitivity Segment	Attack, Atk+Dcy, Decay, Atk+Ris, All	04
		28 1	00 - 7F	FEG Time Velocity Sensitivity	-64 - +63	40
		29 1	00 - 7F	FEG Depth Velocity Sensitivity	-64 - +63	40
		2A 1	00 - 04	FEG Depth Velocity Sensitivity Curve	00 - 04 □□□□	02
		2B 1	00 - 7F	FEG Time Key Follow Sensitivity	-64 - +63	40
		2C 1	00 - 7F	FEG Time Key Follow Sensitivity Center Note	C-2 - G8	18
		2D 1	00 - 7F	Filter Cutoff Key Follow Sensitivity	-200% - +200%	4A
		2E 1	00 - 7C	Filter Cutoff Scaling Break Point 1	C-2 - E8	24
		2F 1	01 - 7D	Filter Cutoff Scaling Break Point 2	C#-2 - F8	30
		30 1	02 - 7E	Filter Cutoff Scaling Break Point 3	D-2 - F#8	3C
		31 1	03 - 7F	Filter Cutoff Scaling Break Point 4	D#-2 - G8	48

**MIDI PARAMETER CHANGE TABLE
(FM PART OPERATOR)**

Address	Size	Data Range (HEX)	Parameter Name	Description	Default (HEX)	Notes
	32	2	00 - 01 00 - 7F	Filter Cutoff Scaling Offset 1	-128 - +127 1st bit6-0 → bit13-7 2nd bit6-0 → bit6-0	01 00
	34	2	00 - 01 00 - 7F	Filter Cutoff Scaling Offset 2	:	01 00
	36	2	00 - 01 00 - 7F	Filter Cutoff Scaling Offset 3	:	01 00
	38	2	00 - 01 00 - 7F	Filter Cutoff Scaling Offset 4	:	01 00
	3A	1	00 - 7F	HPF Cutoff Key Follow Sensitivity	-200% - +200%	40
	3B	1	00 - 64	PEG Initial Level	-50 - +50	32
	3C	1	00 - 64	PEG Attack Level	-50 - +50	32
	3D	1	00 - 64	PEG Decay 1 Level	-50 - +50	32
	3E	1	00 - 64	PEG Decay 2 Level	-50 - +50	32
	3F	1	00 - 64	PEG Release Level	-50 - +50	32
	40	1	00 - 63	PEG Attack Time	0 - 99	00
	41	1	00 - 63	PEG Decay 1 Time	0 - 99	00
	42	1	00 - 63	PEG Decay 2 Time	0 - 99	00
	43	1	00 - 63	PEG Release Time	0 - 99	00
	44	1	00 - 07	PEG Depth Velocity Sensitivity	0 - 7	00
	45	1	00 - 03	PEG Depth	8 oct, 2 oct, 1 oct, 0.5 oct	00
	46	1	00 - 07	PEG Time Key Follow Sensitivity	0 - 7	00
	47	1	00 - 05	2nd LFO Wave	Triangle, Saw Down, Saw Up, Square, Sine, S/H	00
	48	1	00 - 63	2nd LFO Speed	0 - 99	1E
	49	1	00 - 03	2nd LFO Phase	0°, 90°, 180°, 270°	00
	4A	1	00 - 63	2nd LFO Delay Time	0 - 99	00
	4B	1	00 - 01	2nd LFO Key On Reset	Off, On	00
	4C	1	00 - 63	2nd LFO Pitch Modulation Depth	0 - 99	00
	4D	1	00 - 63	2nd LFO Amplitude Modulation Depth	0 - 99	00
	4E	1	00 - 63	2nd LFO Filter Modulation Depth	0 - 99	00
	4F	1	00 - 57	Algorithm Number	1 - 88	00
	50	1	00 - 07	Feedback Level	0 - 7	00
	51	1		reserved		
	52	1		reserved		
	53	1		reserved		
	54	1		reserved		
	55	1		reserved		

TOTAL SIZE = 86 56 (HEX)

p = Part number
0 - F

Address	Size	Data Range (HEX)	Parameter Name	Description	Default (HEX)	Notes
49	op	00 1		reserved		
		01 1	00 - 01	Oscillator Key On Reset	Off, On	01
		02 1		reserved		
		03 1	00 - 01	Oscillator Frequency Mode	Ratio, Fixed	00
		04 1	00 - 1F	Tune Coarse	0 - 31	01
		05 1	00 - 7F	Tune Fine	0 - 127	00
		06 1	00 - 1E	Detune	-15 - 0 - 15	0F
		07 1	00 - 63	Pitch Key Follow Sensitivity	0 - 99	00
						This is available only when Oscillator Mode is set to Fixed.
		08 1	00 - 0E	Pitch Velocity Sensitivity	-7 - 0 - +7	07
		09 1	00 - 06	Spectral Form	Sine, All 1, All 2, Odd 1, Odd 2, Res 1, Res 2	00
		0A 1	00 - 07	Spectral Skirt	0 - 7	00
		0B 1	00 - 63	Spectral Resonance	0 - 99	00
		0C 1	00 - 64	PEG Initial Level	-50 - 0 - +50	32
		0D 1	00 - 64	PEG Attack Level	-50 - 0 - +50	32
		0E 1	00 - 63	PEG Attack Time	0 - 99	00
		0F 1	00 - 63	PEG Decay Time	0 - 99	00
		10 1	00 - 63	AEG Attack Level	0 - 99	63
		11 1	00 - 63	AEG Decay 1 Level	0 - 99	63
		12 1	00 - 63	AEG Decay 2 Level	0 - 99	63
		13 1	00 - 63	AEG Release (Hold) Level	0 - 99	00
		14 1	00 - 63	AEG Attack Time	0 - 99	00
		15 1	00 - 63	AEG Decay 1 Time	0 - 99	00
		16 1	00 - 63	AEG Decay 2 Time	0 - 99	00
		17 1	00 - 63	AEG Release Time	0 - 99	28
		18 1	00 - 63	AEG Hold Time	0 - 99	00
		19 1	00 - 07	AEG Time Key Follow Sensitivity	0 - 7	00
		1A 1	00 - 63	Operator Level	0 - 99	00
						When Operator number is "0," the initial value is 63 (Hex.)
		1B 1	00 - 63	Level Scaling Break Point	A-1 - C8	3C
		1C 1	00 - 63	Level Scaling Low Depth	0 - 99	00
		1D 1	00 - 63	Level Scaling High Depth	0 - 99	00
		1E 1	00 - 03	Level Scaling Low Curve	-Linear, -Exp, +Exp, +Linear	00
		1F 1	00 - 03	Level Scaling High Curve	-Linear, -Exp, +Exp, +Linear	00
		20 1	00 - 0E	Level Velocity Sensitivity	-7 - 0 - +7	07
		21 1	00 - 07	2nd LFO Pitch Modulation Depth Offset	0 - 7	03
		22 1	00 - 07	2nd LFO Amplitude Modulation Depth Offset	0 - 7	03
		23 1	00 - 0E	Pitch Controller Sensitivity	-7 - 0 - +7	07
		24 1	00 - 0E	Level Controller Sensitivity	-7 - 0 - +7	07
		25 5	00 - 00 00 - 00 00 - 03 00 - 7F 00 - 7F	Controller Set 1 - 16 Element Switch	1st reserved 2nd reserved 3rd bit1-0 → bit15-14 4th bit6-0 → bit13-7 5th bit6-0 → bit6-0 0 - 0000FFFFh, bit 0: Box1 - bit 15: Box16	00 00 03 7F 7F
		2A 5		reserved		

TOTAL SIZE = 47 2F (HEX)

o = Operator number
0 - 7

p = Part number
0 - F

Function...	Transmitted	Recognized	Remarks
Basic Channel Default Changed	1 - 16 1 - 16	1 - 16 X	Memorized
Mode Default Messages Altered	3 X *****	3 X X	Memorized
Note Number : True voice	0 - 127 *****	0 - 127 0 - 127	
Velocity Note ON Note OFF	O 9nH,v=1-127 X 9nH,v=0	O 9nH,v=1-127 X	
After Touch Key's Ch's	X O	X O	*1
Pitch Bend	O	O	*1
Control Change	0,32 O *1 1,11 O 7,10 O 5 O 6,38 X 64 O 65 X 66 X 71-75 O 91,94 O 96-97 X 100-101 X 1-95 O	O *1 O *1 O *1 O *1 O *1 O *1 O *1 O *1 O *1 O *1 O *1 O *1 O *1	Bank Select Portamento Time Data Entry Sustain Sw Portamento Sw Sostenuto Sound Controller Effect Depth RPN Inc,Dec RPN LSB,MSB Assignable Cntrl
Prog Change : True #	O 0 - 127 *1 *****	O 0 - 127 *1 0 - 127 *1	
System Exclusive	O	O	
Common : Song Pos. : Song Sel. : Tune	X X X	X X X	
System : Clock Real Time : Commands	X X	O *2 X	
Aux : All Sound Off : Reset All Cntrls : Local ON/OFF Mes- : All Notes OFF sages: Active Sense : Reset	X X X X O X	O (120,126,127) O (121) X O (123-125) O X	
Notes: *1 receive/transmit if switch is on. *2 if MIDI Sync is MIDI.			

Mode 1 : OMNI ON , POLY
 Mode 3 : OMNI OFF, POLY

Mode 2 : OMNI ON ,MONO
 Mode 4 : OMNI OFF,MONO

O : Yes
 X : No

Function...	Transmitted	Recognized	Remarks
Basic Channel Default Changed	1 - 16 X	1 - 16 X	Memorized
Mode Default Messages Altered	X X *****	X X X	
Note Number : True voice	0 - 127 *****	0 - 127 0 - 127	
Velocity Note ON Note OFF	O 9nH,v=1-127 X 9nH,v=0	O 9nH,v=1-127 X	
After Touch Key's Ch's	O O	O O	
Pitch Bend	O	O	
Control Change 0-121	O	O	
Prog Change : True #	O 0 - 127 *****	O 0 - 127	
System Exclusive	O	O	
Common : Song Pos. : Song Sel. : Tune	O X X	O X X	
System : Clock Real Time : Commands	O *2 O *1	O *3 O *1	
Aux : All Sound Off : Reset All Cntrls : Local ON/OFF Mes- : All Notes OFF sages: Active Sense : Reset	O O O O X X	O O O O X X	
Notes: *1 if Song Play/Stop Receive/Transmit is on. *2 if MIDI Clock Out is on. *3 if MIDI Sync is MIDI.			

Mode 1 : OMNI ON , POLY
 Mode 3 : OMNI OFF, POLY

Mode 2 : OMNI ON , MONO
 Mode 4 : OMNI OFF, MONO

O : Yes
 X : No

Yamaha Web Site (English only)
<https://www.yamahasyth.com/>

Yamaha Downloads
<http://download.yamaha.com/>