

MOXF6/MOXF8

Reference Manual

Contents

Using the MOXF6/MOXF8 Manuals	2	Master Mode.....	128
Basic Structure	3	Remote Mode	133
Functional Blocks	3	Utility Mode	140
Tone Generator Block	4	Quick Setup.....	151
A/D Input Block.....	8	File Mode	153
Sequencer Block.....	9	Supplementary Information	160
Arpeggio Block	11	File/Folder selection.....	160
Controller Block.....	17	Playing back a SMF (Standard MIDI file) from	
Effect Block.....	18	USB flash memory	160
Internal Memory	22	Formatting a USB flash memory device	161
Reference	24	Using iOS Applications	162
Voice Mode	25	Appendix	163
Supplementary Information	53	About MIDI.....	163
Voice Category List.....	53		
Setting examples of the Destination.....	53		
Functions of Knobs 1 – 8.....	54		
Performance Mode	55		
Supplementary Information	74		
Performance Category List	74		
Functions of Knobs 1 – 8.....	74		
Song Mode	76		
Supplementary Information	97		
Song Playback Types	97		
Song Track Loop – setting example.....	99		
Punch In/Out (Type = punch).....	100		
Basic Procedure in the Song Job Mode	100		
Pattern Mode	101		
Supplementary Information	112		
Pattern Playback Types	112		
Loop Recording (Pattern).....	113		
Mixing Mode	114		
Supplementary Information	124		
Editing a Performance by using the Knobs.....	124		
Creating an Arpeggio.....	125		
Storing the Mixing settings as a Mixing Template.....	126		

Using the MOXF6/MOXF8 Manuals

Your MOXF6/MOXF8 synthesizer comes with four different reference guides — the Owner's Manual, the Reference Manual (this document), the Synthesizer Parameter Manual, and the Data List. While the Owner's Manual is packaged together with the synthesizer as a hardcopy booklet, this Reference Manual, Synthesizer Parameter Manual, and the Data List are provided as PDF documents on the bundled CD-ROM.



Owner's Manual (hardcopy booklet)

Describes how to set up your MOXF6/MOXF8 and how to perform basic operations.

This manual explains the following operations.

- Playing in the Voice mode
- Creating a new Performance by using your favorite Voice (Performance Creator)
- Playing in the Performance mode
- Using a microphone and sounds from other audio devices
- Creating an original Song
- Making your own Patterns
- Connecting to a computer
- Using as a master keyboard (Master mode)
- Making global system settings (Utility mode)
- Saving/loading data (File mode)
- Installing optional hardware



Reference Manual (this PDF document)

Describes the internal design of your MOXF6/MOXF8 and the various parameters that can be adjusted and set.



Synthesizer Parameter Manual (PDF document)

Explains the voice parameters, effect types, effect parameters, and MIDI messages that are used for synthesizers incorporating the Yamaha AWM2 sound generators. Read the Owner's Manual and Reference Manual first and then use this parameter manual, if necessary, to learn more about parameters and terms that relate to Yamaha synthesizers.



Data List (PDF document)

Provides lists such as the Waveform List, Performance List, Effect Type List, Arpeggio Type List, as well as reference materials such as the MIDI Implementation Chart and Remote Control Function List.

Using the Reference Manual

- Using the mode tabs along the upper part of each page from the Reference section, you can jump to the page for parameter explanations of the corresponding mode. The list indicated at the right of each page in the selected mode is equivalent to the function tree. By clicking the desired item from this list, you can jump to the page for the corresponding function's explanations.
- You can click on any page number from the Table of Contents or within descriptive text to jump to the corresponding page.
- You can also click on desired items and topics you want to refer to in the "Bookmarks" index to the left of the main window, and jump to the corresponding page. (Click the "Bookmarks" tab to open the index if it is not displayed.)
- If you want to find information on a specific topic, function or feature, select "Find" or "Search" from the Adobe Reader "Edit" menu and enter a key word to locate the related information anywhere in the document.

NOTE The most-recent version of Adobe® Reader® can be downloaded from the following web page.

<http://www.adobe.com/products/reader/>

NOTE The names and positions of menu items may vary according to the version of Adobe Reader being used.

Information

- The illustrations and LCD screens as shown in this Reference Manual are for instructional purposes only, and may appear somewhat different from those on your instrument.
- All other trademarks are the property of their respective holders.

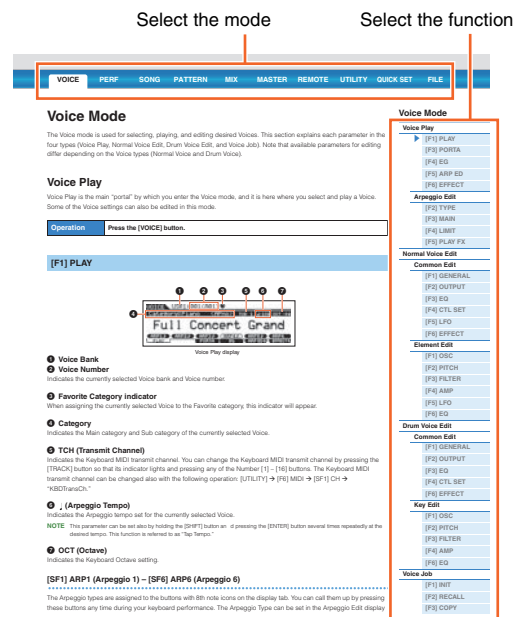

Basic Structure

Functional Blocks

The MOXF6/MOXF8 system consists of six main functional blocks: Tone Generator, A/D Input, Sequencer, Arpeggio, Controller, and Effect.

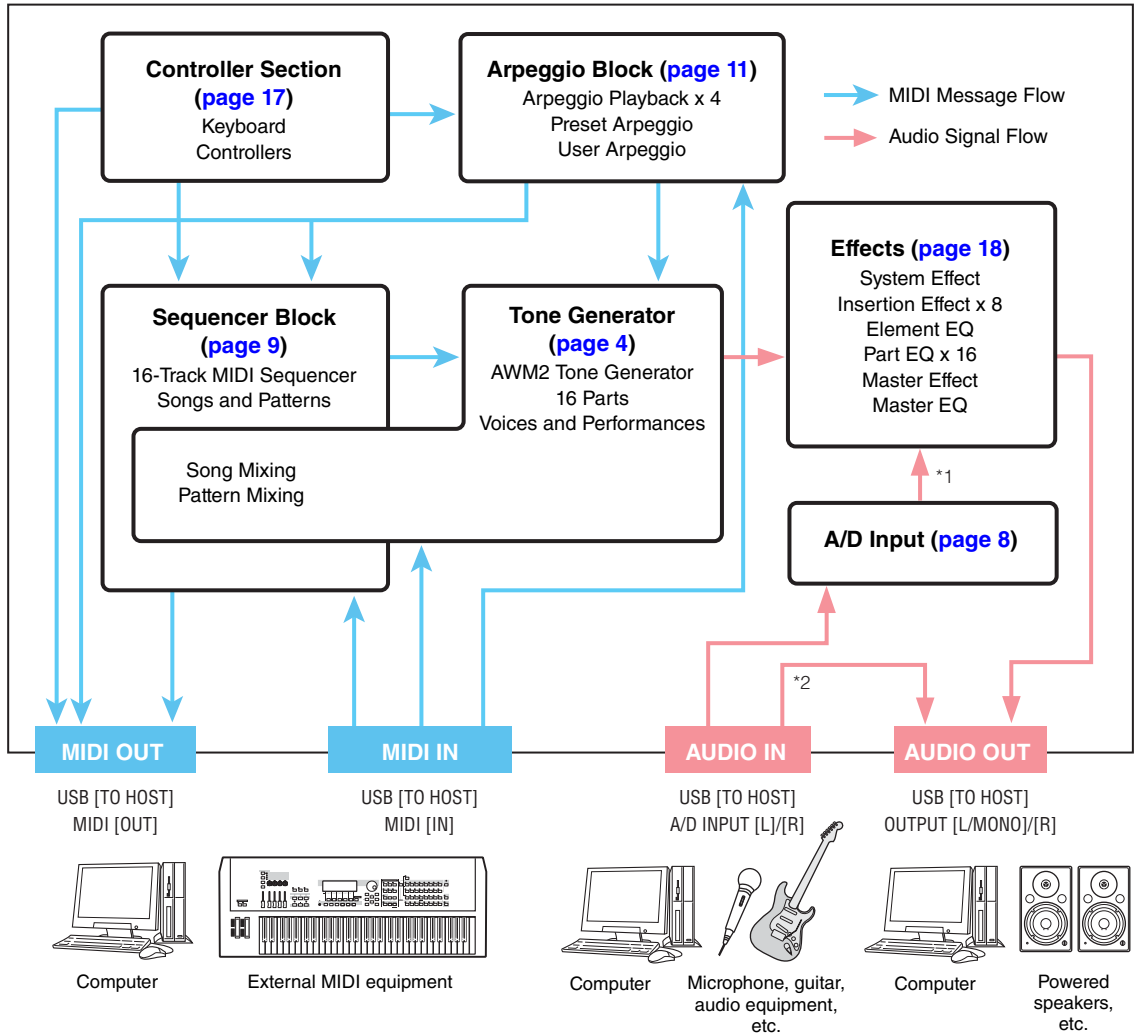

*1 Depending on the settings for the audio signal connections, the signals input via the A/D INPUT [L]/[R] jacks may not be sent to the system effect or master effect.
 *2 The audio signals input via the USB [TO HOST] terminal are output to the OUTPUT [L/MONO]/[R] jacks directly, bypassing the A/D Input block and Effect block.

Basic Structure

- ▶ Functional blocks
- Tone Generator block
- A/D Input block
- Sequencer block
- Arpeggio block
- Controller block
- Effect block
- Internal memory

Reference

- Voice mode
- Performance mode
- Song mode
- Pattern mode
- Mixing mode
- Master mode
- Remote mode
- Utility mode
- Quick setup
- File mode

Using iOS Applications

Appendix

MIDI

AWM2 (Advanced Wave Memory 2)

This instrument is equipped with a AWM2 tone generator block. AWM2 (Advanced Wave Memory 2) is a synthesis system based on sampled waves (sound material), and is used in many Yamaha synthesizers. For extra realism, each AWM2 Voice uses multiple samples of a real instrument's waveform. Furthermore, a wide variety of parameters—envelope generator, filter, modulation, and others—can be applied.

Tone Generator Block

The tone generator block is what actually produces sound in response to the MIDI messages received from the Sequencer block, Controller block, Arpeggio block and from the external MIDI instrument via the MIDI [IN] terminal or the USB [TO HOST] terminal. The MIDI messages are assigned to sixteen independent channels, and the instrument is capable of simultaneously playing sixteen separate Parts, via the sixteen MIDI channels. However, the sixteen-channel limit can be overcome by using separate MIDI “ports,” each supporting sixteen channels. The tone generator block of this instrument can handle MIDI messages over Port 1. The structure of the tone generator block differs depending on the mode.

Tone Generator block in the Voice Mode

Part structure in the Voice mode

Only one MIDI channel can be recognized in the Voice mode because only one part is available in this mode. This status is referred to as a “single timbre” tone generator. A Voice is played from the keyboard, using a single part. To set the MIDI receive channel for single timbre operation (Voice and Performance modes), use the “BasicRcvCh” parameter (page 147) in the Utility MIDI display. In the Voice mode, the instrument recognizes only data over MIDI Port 1.

NOTE If you want to play Song data on an external MIDI sequencer or computer consisting of multiple MIDI channels, make sure to use the Song/Pattern mode (page 76).

Voice

A program that contains the sonic elements for generating a specific musical instrument sound is referred to as a “Voice.” Internally, there are two Voice types: Normal Voices and Drum Voices. Normal Voices are mainly pitched musical instrument type sounds that can be played over the range of the keyboard. Each Voice consists of up to eight Elements (Normal Voice) or up to 73 keys (Drum Voice). An Element or Drum Key is the basic and the smallest unit for a Voice. This means that only one Element or key can produce a musical instrument sound. In addition, a Normal Voice can produce even more realistic sound or various types of sound by combining multiple Elements. Each Voice is created by editing parameters unique to each Element/Key (Element Edit parameters/Key Edit parameters) and parameters common to all the Elements/Keys (Common Edit parameters).

NOTE For instructions on editing a Normal Voice, see page 30. For instructions on editing a Drum Voice, see page 47.

Normal Voices and Drum Voices

Normal Voices

This is a Voice which is played conventionally from the keyboard, with standard pitches sounding for each key. A Normal Voice consists of up to eight Elements. Depending on the settings in the Voice Edit mode, these Elements are sounded simultaneously, or different Elements are sounded according to the note range, velocity range and the XA (Expanded Articulation) settings. The illustration is an example of a Normal Voice. Since the six Elements here are distributed across both the note range of the keyboard and the velocity range, a different Element sounds depending on which note you play and how strongly you play it. In the velocity distribution, Elements 1, 3 and 5 sound when playing the keyboard softly, while Elements 2, 4 and 6 sound when playing it strongly. In the note distribution, Elements 1 and 2 sound in the lower range of the keyboard, Elements 3 and 4 sound in the middle range, and Elements 5 and 6 sound in the higher range. In the velocity distribution, Elements 1, 3 and 5 sound when playing the keyboard softly, while Elements 2, 4 and 6 sound when playing it strongly. In a practical example of this in use, a piano Voice could be composed of six different samples. Elements 1, 3 and 5 would be the sounds of the piano played softly, over the respective note ranges, while Elements 2, 4 and 6 would be strongly played sounds, for each respective note range. Actually, the MOXF6/MOXF8 is even more flexible than this, since it allows up to eight independent Elements.

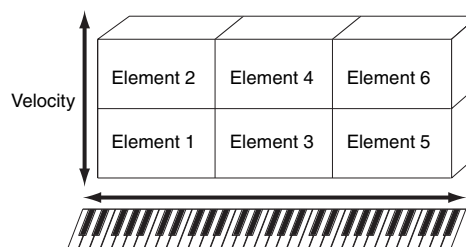

Basic Structure

Functional blocks

▶	Tone Generator block
	A/D Input block
	Sequencer block
	Arpeggio block
	Controller block
	Effect block
	Internal memory

Reference

Voice mode
Performance mode
Song mode
Pattern mode
Mixing mode
Master mode
Remote mode
Utility mode
Quick setup
File mode

Using iOS Applications

Appendix

MIDI

Drum Voices

Drum Voices are mainly percussion/drum sounds that are assigned to individual notes on the keyboard. Unlike Elements, a Drum key is equivalent to the corresponding note, meaning that you cannot change its range. Drum or percussion sounds are assigned to each Drum Key. You can create various types of Drum Voices by changing the drum or percussion sound assigned to each key and edit the parameters such as pitch and EG.

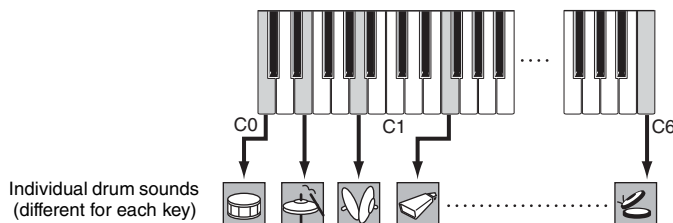

Expanded Articulation (XA)

Expanded Articulation (XA) is a specially designed tone generation system that provides greater performance flexibility and acoustic realism. It allows you to more effectively recreate realistic sound and natural performance techniques—such as legato and staccato—and provides other unique modes for random and alternate sound changes as you play.

Realistic legato performance

Conventional synthesizers recreate a legato effect by continuing the volume envelope of a previous note on to the next one, in the mono mode. However, this results in an unnatural sound different from that of an actual acoustic instrument. The MOXF more accurately reproduces a legato effect by allowing specific Elements to be sounded when playing legato and other Elements to be played normally (with the XA Control parameter settings “normal” and “legato”).

Authentic note release sound

Conventional synthesizers cannot adequately produce the sounds of notes on acoustic instruments being released. The MOXF6/MOXF8 reproduces these special, characteristic sounds by setting the XA Control parameter of certain Elements to “keyOffSound.”

Subtle sound variations for each note played

Conventional synthesizers attempt to reproduce this by randomly changing the pitch and/or filter. However, this produces an electronic effect and is different from the real sound changes on an acoustic instrument. The MOXF6/MOXF8 more accurately reproduces these subtle sound variations by using the XA Control parameter settings “waveCycle” and “waveRandom.”

Switching among different sounds to recreate the natural performance on an acoustic instrument

Acoustic instruments have their own unique characteristics—even specific, unique sounds that are produced only at certain times in a performance. These include the flutter tonguing on a flute or the playing of high harmonics on an acoustic guitar. Conventional synthesizers (before the MOTIF XS series) could realize such sounds, for example, by triggering them through high (strong) velocity. The MOXF6/MOXF8 recreates these by allowing you to switch between the sounds while you play—using the ASSIGNABLE FUNCTION [1]/[2] buttons and the XA Control parameter settings, “AF1 On,” “AF2 On” and “all AF off.”

NOTE You can turn the ASSIGNABLE FUNCTION [1]/[2] button on or off also by transmitting the Control Change number specified as “AF1”/“AF2” (page 146) in the Utility CTL ASN display from an external device.

New sounds and new styles of playing

The highly versatile functions above can be applied effectively not only to acoustic sounds but also to synthesizer and electronic Voices as well. The XA feature opens up enormous potential for realizing authentic sounds, performing expressively and coming up with creative new styles of playing.

Basic Structure

Functional blocks

▶ Tone Generator block
A/D Input block
Sequencer block
Arpeggio block
Controller block
Effect block
Internal memory

Reference

Voice mode
Performance mode
Song mode
Pattern mode
Mixing mode
Master mode
Remote mode
Utility mode
Quick setup
File mode

Using iOS Applications

Appendix

MIDI

Elements and Drum Keys

Elements and Drum Keys are the smallest “building blocks” in the MOXF6/MOXF8 that comprise a Voice; in fact, only one Element or one Drum Key could be used to create a Voice. These small sound units can be built, enhanced and processed by a variety of traditional synthesizer parameters, such as Oscillator, Pitch, Filter, Amplitude, and LFO (shown below).

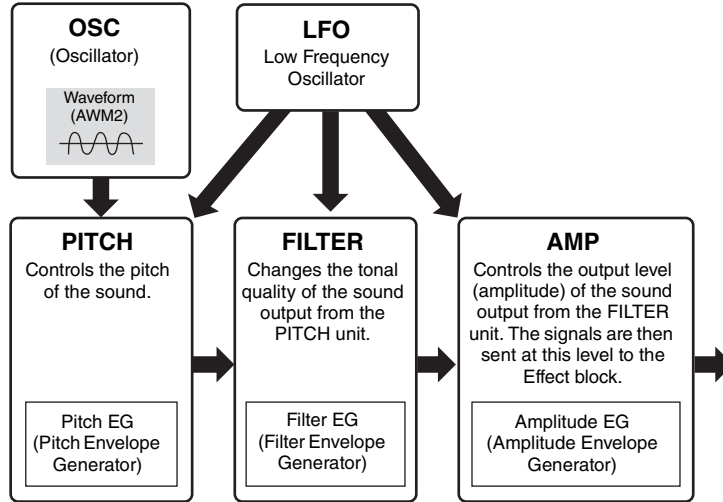

Oscillator

This unit outputs the wave which determines the basic pitch. You can assign the waveform (or basic sound material) to each Element of a Normal Voice or each Key of a Drum Voice. In the case of a Normal Voice, you can set the note range for the Element (the range of notes on the keyboard over which the Element will sound) as well as the velocity response (the range of note velocities within which the Element will sound). In addition, the XA related parameters of this unit can be set. Each waveform consists of sample(s) created by recording the sound of the actual instrument and assigning appropriate keyboard and velocity settings. Oscillator related parameters can be set in the Oscillator display (pages 38 and 48).

Pitch

This unit controls the pitch of the sound (wave) output from the Oscillator. In the case of a Normal Voice, you can detune separate Elements, apply Pitch Scaling and so on. Also, by setting the PEG (Pitch Envelope Generator), you can control how the pitch changes over time. Pitch related parameters can be set in the PITCH display (page 40) of the Voice Element Edit. Note that the Pitch related parameters of a Drum Voice can be set in the PITCH display (page 49) of Drum Voice Key Edit.

Filter

This unit modifies the tone of the sound output from Pitch by cutting the output of a specific frequency portion of the sound. Also, by setting the FEG (Filter Envelope Generator), you can control how the Cutoff Frequency of the Filter changes over time. Filter related parameters can be set in the FILTER display (pages 41 and 50) of Voice Element Edit or Drum Voice Key Edit.

Amplitude

This unit controls the output level (amplitude) of the sound output from the Filter block. The signals are then sent at this level to the Effect block. Also, by setting the AEG (Amplitude Envelope Generator), you can control how the volume changes over time. Amplitude related parameters can be set in the AMP display (pages 43 and 50) of Voice Element Edit or Drum Voice Key Edit.

LFO (Low Frequency Oscillator)

As its name suggests, the LFO produces a wave of a low frequency. These waves can be used to vary the pitch, filter or amplitude of each Element to create effects such as vibrato, wah and tremolo. LFO can be set independently for each Element; it can also be set globally for all Elements. LFO related parameters can be set in the LFO display (pages 33 and 45) of Voice Common Edit or Voice Element Edit.

Basic Structure

Functional blocks

- ▶ Tone Generator block
- A/D Input block
- Sequencer block
- Arpeggio block
- Controller block
- Effect block
- Internal memory

Reference

- Voice mode
- Performance mode
- Song mode
- Pattern mode
- Mixing mode
- Master mode
- Remote mode
- Utility mode
- Quick setup
- File mode

Using iOS Applications

Appendix

MIDI

Memory structure of Voices

Normal Voices

Preset Banks 1 – 9	1152 Normal Voices (128 Voices for each Bank)
User Banks 1 – 3	384 Voices (128 Voices for each Bank)
GM Bank	128 Voices

Drum Voices

Preset Drum Bank	72 Voices
User Drum Bank	32 Voices
GM Drum Bank	1 Voice

Basic Structure

Functional blocks

▶ Tone Generator block

A/D Input block

Sequencer block

Arpeggio block

Controller block

Effect block

Internal memory

Reference

Voice mode

Performance mode

Song mode

Pattern mode

Mixing mode

Master mode

Remote mode

Utility mode

Quick setup

File mode

Using iOS Applications

Appendix

MIDI

Tone Generator block in the Performance mode

Part structure in the Performance mode

In this mode, the tone generator block receives MIDI data over a single channel. This status is referred to as a “single timbre” tone generator. This mode lets you play a Performance (in which multiple Voices or Parts are combined—in a layer, or in other configurations) using the keyboard. Keep in mind that Song data on an external sequencer consisting of multiple MIDI channels will not play back properly in this mode. If you are using an external MIDI sequencer or computer to play the instrument, make sure to use the Song mode or Pattern mode.

Performance

A program in which multiple Voices (Parts) are combined in a layer, or in other configurations is referred to as a “Performance.” Each Performance can contain up to four different Parts (Voices). Each Performance can be created by editing parameters unique to each Part and parameters common to all Parts in Performance mode ([page 55](#)).

Performance Memory contents

Two User Banks are provided. Each Bank contains 128 Performances, for a total of 256 User Performances.

Tone Generator block in the Song mode/Pattern mode

Part structure of the tone generator block in the Song mode/Pattern mode

In these modes, multiple Parts are provided and different Voices and different melodies or phrases can be played back for each Part. A MIDI tone generator that simultaneously receives over multiple MIDI channels and plays multiple instrument Parts is referred to as a “multi-timbral” tone generator. The settings for the multi-timbral tone generator are collectively referred to as a “Mixing.” You can use the Mixing when playing the MOXF6/MOXF8 sounds by using an external MIDI sequencer as well as using the sequencer block of the instrument. In this case, you should use the Mixing of the Song or Pattern that does not contain any sequence data.

About Mixing

A program in which multiple Voices are assigned to Parts for multi-timbral play in the Song and Pattern modes is referred to as a “Mixing.” Each Mixing can contain up to 16 parts. Each Mixing can be created by editing parameters unique to each Part and parameters common to all Parts in the Mixing mode ([page 114](#)).

Also, one Mixing has up to sixteen memory locations for saving Normal Voices. These Voices which are saved are called Mixing Voices. Normally, the Voice stored in the Voice mode is assigned to each

Mixing Part. In this case, the sound of the Song/Pattern you created may change unexpectedly if you edit or delete the Voice used for the Song/Pattern Mixing in the Voice mode. Mixing Voices are provided to prevent these accidental sound changes.

Memory structure of Mixing

A Mixing program is provided for each Song or Pattern. Selecting a different Song/Pattern calls up a different Mixing program. A Mixing Voice provides 16 memories for each Mixing program (Song or Pattern). Selecting a different Song/Pattern calls up the different Mixing Voice as well as the Mixing program. If you wish to use a Mixing Voice of a certain Song/Pattern for another Song/Pattern, execute the Copy operation (page 123) in the Mixing Voice Job. Note that up to 256 Mixing Voices can be stored for all Songs and Patterns. If the memory for Mixing Voices is full, delete the Mixing Voices you don't need by executing the Delete job of the Mixing Voice job.

Maximum Polyphony

Maximum polyphony refers to the highest number of notes that can be sounded simultaneously from the internal tone generator of the instrument. The maximum polyphony of this synthesizer is 128. When the internal tone generator block receives a number of notes exceeding the maximum polyphony, previously played notes are cut off. Keep in mind this may be especially noticeable with Voices not having decay. Furthermore, the maximum polyphony applies to the number of Voice Elements used, not the number of Voices. When Normal Voices that include up to eight Elements are used, the maximum number of simultaneous notes may be less than 128.

A/D Input Block

This block handles the audio signal input from the A/D INPUT [L]/[R] jacks. Various parameters such as volume, pan, and effect can be set for the audio signal and the sound is output together with other Voices. The Insertion Effect as well as the System Effects can be applied to the audio signal input via the A/D INPUT [L]/[R] jacks. The A/D Input block related parameters can be set in the following display.

Mode	Display	Corresponding page in the Reference Manual
Voice mode	VCE A/D display in the Utility mode	Page 145
Performance mode	A/D IN display in Performance Common Edit	Page 62
Song/Pattern mode	A/D IN display in Mixing Common Edit	Page 116

The effect which is applied to the audio signal input from the A/D INPUT [L]/[R] jacks is set in the USB I/O display (page 146) of the Utility mode. The gain of the audio signal from the A/D INPUT [L]/[R] jacks can be adjusted via the A/D INPUT [GAIN] knob on the panel. Moreover, the on/off setting of the audio signal from the A/D INPUT [L]/[R] jacks can be set via the A/D INPUT [ON/OFF] button.

Basic Structure

Functional blocks

- ▶ Tone Generator block
- ▶ A/D Input block
- Sequencer block
- Arpeggio block
- Controller block
- Effect block
- Internal memory

Reference

- Voice mode
- Performance mode
- Song mode
- Pattern mode
- Mixing mode
- Master mode
- Remote mode
- Utility mode
- Quick setup
- File mode

Using iOS Applications

Appendix

MIDI

Sequencer Block

This lets you create Songs and Patterns by recording and editing your performances as MIDI data (from the controller block), allowing you to play the data back with the tone generator block.

Sequencer block in the Song mode

About Songs

A Song is created by recording your keyboard performance as MIDI sequence data to individual Tracks. A Song on this synthesizer is effectively the same as a Song on a MIDI sequencer, and playback automatically stops at the end of the recorded data.

Song Track structure

A Song consists of 16 separate Tracks, a Scene Track, and a Tempo Track. You can record these Tracks by using Realtime recording or Step recording (page 79). Moreover, you can insert or edit the recorded data using Song Edit (page 84).

Sequence Tracks 1 – 16

Lets you record MIDI data.

Scene Track

Lets you record Scene change settings, such as Track mute and solo. These can be set in the Song Play display (page 76) and recalled during Song playback. During Song playback, the Track mute and solo settings change automatically according to the settings you've recorded to the Scene Track.

Tempo Track

Lets you record Tempo change settings. During Song playback, the Tempo changes automatically according to the settings you've recorded to this Track.

Song Chain

This function allows Songs to be "chained" together for automatic sequential playback. You can set the playback order in Song Play (page 76).

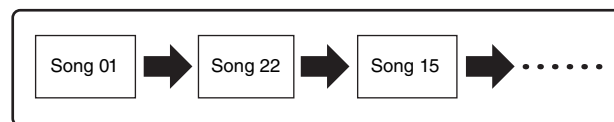

Sequencer block in the Pattern mode

About Patterns

In the MOXF6/MOXF8, the term "Pattern" refers to a relatively short musical or rhythmic Phrase—1 to 256 measures—which is used for looped playback. Therefore, once Pattern playback starts, it continues until you press the [■] (Stop) button.

Section

Patterns are more than just a single Phrase—they include 16 variations called "Sections." These Sections can be changed during playback and used as rhythmic/backing variations for the various parts of a Song. For example, you could use one Section for the verse, another for the chorus, and a third for the bridge. The Pattern related settings such as tempo and Mixing do not change even when the Section is switched, keeping the overall playback consistent in feel and rhythm through the changes. You can use the Section function as a convenient compositional tool, instantly creating the backing Pattern variations for a Song, such as melody A, melody B, and main theme. For instructions on changing Patterns and Sections, see the MOXF6/MOXF8 Owner's Manual.

Basic Structure

Functional blocks

Tone Generator block

A/D Input block

▶ Sequencer block

Arpeggio block

Controller block

Effect block

Internal memory

Reference

Voice mode

Performance mode

Song mode

Pattern mode

Mixing mode

Master mode

Remote mode

Utility mode

Quick setup

File mode

Using iOS Applications

Appendix

MIDI

Pattern Chain

Pattern Chain allows you to string several different Sections (within a single Pattern) together to make a single, complete Song. You can have the MOXF6/MOXF8 automatically change Sections by creating a Pattern Chain beforehand, recording Pattern playback with Section changes from the Pattern Chain display. One Pattern Chain can be created for each Pattern in the Pattern Chain display (page 103). You can also use this feature when creating Songs based on a certain Pattern, since the created Pattern Chain can be converted into a Song in Pattern Chain Edit (page 104).

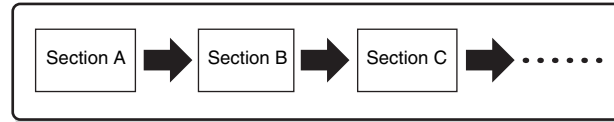

Phrase

This is the basic MIDI sequence data in a Track—and the smallest unit—used in creating a Pattern. “Phrases” are short musical/rhythmic passages for a single instrument, such as a rhythm pattern for the rhythm part, a bass line for the bass part, or a chord backing for the guitar part. This synthesizer features memory space for 256 of your own original User Phrases.

NOTE The MOXF6/MOXF8 provides no Preset Phrases.

Pattern Track Structure

A Pattern consists of 16 separate Tracks. See “Sequence Tracks 1 – 16” of “Song Track Structure.” (Page 9)

Pattern Tracks and Phrases

A Pattern consists of 16 Tracks to which the Phrase can be assigned. MIDI data cannot be directly recorded to each Track in the Pattern mode. Recording is done to an empty User Phrase. The newly created Phrase is automatically assigned to the recording Track.

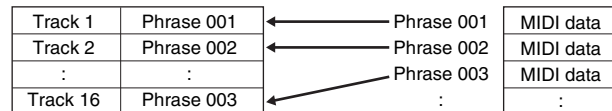

Sequencer block applied to both Songs and Patterns

MIDI Tracks and Mixing settings

MIDI Tracks are created by recording your keyboard performance in the Song Record mode/Pattern Record mode. MIDI sequence data is recorded to the MIDI Track and the Normal Voice or Drum Voice is assigned to the Mixing part corresponding to the Track. To edit the Mixing parameters such as Voice, volume and pan for each Track, press the [MIXING] button to enter the Mixing mode (page 114), then edit them for the Mixing Part corresponding to the desired Track. Note that Track 1 does not always correspond to Mixing Part 1. As illustrated below, each Track of the Song sequence data and each Mixing Part of the tone generator block are connected when the output channel (TxCH) equals the receive channel (RcvCH). In other words, the sequence data of each Track plays the corresponding Parts (those having the same MIDI channel assignment) in the tone generator block. The Transmit Channels of each Track can be set in the TRACK display (page 78) of the Song mode or Pattern mode while the Receive Channels of each Part can be set in the VOICE display (page 117) of Mixing Edit.

Basic Structure

Functional blocks

Tone Generator block

A/D Input block

▶ Sequencer block

Arpeggio block

Controller block

Effect block

Internal memory

Reference

Voice mode

Performance mode

Song mode

Pattern mode

Mixing mode

Master mode

Remote mode

Utility mode

Quick setup

File mode

Using iOS Applications

Appendix

MIDI

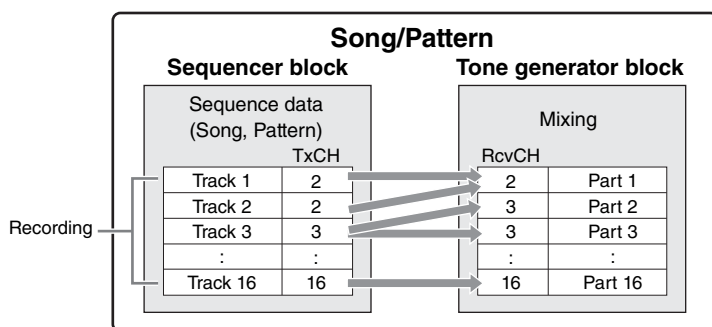

NOTE When you play the keyboard in the Mixing mode, the selected Part will not sound, but the Part assigned to the same numbered Track as the selected part will sound. For example, when setting as in the above illustration, playing the keyboard sounds Part 1 even if Part 2 is selected in the Mixing mode.

Basic Structure

- Functional blocks
- Tone Generator block
- A/D Input block
- ▶ Sequencer block
- ▶ Arpeggio block
- Controller block
- Effect block
- Internal memory

Reference

- Voice mode
- Performance mode
- Song mode
- Pattern mode
- Mixing mode
- Master mode
- Remote mode
- Utility mode
- Quick setup
- File mode

Using iOS Applications

Appendix

MIDI

Sequencer block applied to the Performance mode

Performance Recording

You can record your keyboard performance in the Performance mode to the Song or Pattern. You can record knob operations, controller operations and Arpeggio playback as well as your keyboard playing to the specified Track as MIDI events.

NOTE In Performance recording, operating the knobs only result in the Control Change messages being recorded; Parameter Change messages cannot be recorded. For details regarding Control Change messages, see the "Synthesizer Parameter Manual" PDF document.

Arpeggio playback data for Parts 1 – 4 of the Performance will be recorded to the specified four Tracks (in the REC TR display of Performance Record) of the Song/Pattern respectively. Your keyboard performance and controller/knob operations (common to Parts 1 – 4) will be recorded to Tracks 1 – 4 separately.

NOTE For details on operation, refer to the MOXF6/MOXF8 Owner's Manual.

Arpeggio Block

This block lets you automatically trigger musical and rhythmic phrases using the current Voice by simply pressing a note or notes on the keyboard. The Arpeggio sequence also changes in response to the actual notes or chords you play, giving you a wide variety of inspiring musical phrases and ideas—both in composing and performing. Four Arpeggio types can be played back at the same time even in the Song mode and Pattern mode.

Arpeggio categories

The Arpeggio types are divided into 16 categories (excepting "NoAsg") as listed below. The categories are based on instrument type.

Category List

ApKb	Acoustic Piano & Keyboard
Organ	Organ
GtPl	Guitar / Plucked
GtMG	Guitar for "Mega Voice"
Bass	Bass
BaMG	Bass for "Mega Voice"
Strng	Strings
Brass	Brass
RdPp	Reed / Pipe

Lead	Synth Lead
PdMe	Synth Pad / Musical Effect
CPrC	Chromatic Percussion
DrPc	Drum / Percussion
Seq	Synth Seq
Hybrd	Hybrid Seq
Cntr	Control
NoAsg	No Assignment

NOTE Categories named "GtMG" and "BaMG" include Arpeggio types appropriate for using with a Mega Voice.

Mega Voices and Mega Voice Arpeggios

Normal Voices use velocity switching to make the sound quality and/or level of a Voice change according to how strongly or softly you play the keyboard—giving greater authenticity and natural response to these Voices. However Mega Voices have a very complex structure with many different layers that is not suitable for playing manually. Mega Voices were developed specifically to be played by Mega Voice arpeggios to produce incredibly realistic results. You should always use Mega Voices with Mega Voice Arpeggios (included in “GtMG” and “BaMG” category). For details regarding the Mega Voice Arpeggios, see the “Voice Type” of the “Arpeggio Type List” in the “Data List” PDF document.

Basic Structure

Functional blocks

Tone Generator block

A/D Input block

Sequencer block

▶ Arpeggio block

Controller block

Effect block

Internal memory

Sub categories

The Arpeggio categories are divided into the sub categories listed below. Because the sub categories are listed based on the music genre, it is easy to find the sub category appropriate for your desired music style.

Sub Category List

Rock	Rock
PopRk	Pop Rock
Balad	Ballad
HipHp	Hip Hop
R&B-M	R&B Modern
R&B-C	R&B Classic
Funk	Funk
Tekno	Techno / Trance
House	House / Dance Pop
D&B	D&B / Breakbeats
Chill	Chillout / Ambient
Jazz	Jazz / Swing
Latin	Latin

World	World
Genrl	General
Comb	Combination
Zone	Zone Velocity*
Z.Pad	Zone Velocity for Pad*
Filtr	Filter
Exprs	Expression
Pan	Pan
Mod	Modulation
Pbend	Pitch Bend
Asign	Assign 1/2
---	No Assignment

NOTE Arpeggio types belonging to the Sub Categories marked with an asterisk (*) contain some velocity ranges, to which each has a different phrase assigned. When a type of these categories is selected in the Voice mode, it is a good idea to set the Velocity Limit of each Element to the same range as below.

Velocity ranges of each Arpeggio type.

2Z_****: 1 – 90, 91 – 127

4Z_****: 1 – 70, 71 – 90, 91 – 110, 111 – 127

8Z_****: 1 – 16, 17 – 32, 33 – 48, 49 – 64, 65 – 80, 81 – 96, 97 – 108, 109 – 127

PadL_****: 1 – 1, 2 – 2, 3 – 127

PadH_****: 1 – 112, 113 – 120, 121 – 127

Reference

Voice mode

Performance mode

Song mode

Pattern mode

Mixing mode

Master mode

Remote mode

Utility mode

Quick setup

File mode

Using iOS Applications

Appendix

MIDI

Arpeggio Type Name

The Arpeggio Types are named according to certain rules and abbreviations. Once you understand these rules and abbreviations, you'll find it easy to browse through and select the desired Arpeggio Types.

Arpeggio type with “_ES” at the end of the type name (example: HipHop1_ES)

These Arpeggio types use the same multi Track Arpeggio architecture as the MOTIF ES. This ES type of arpeggio has the following benefits: 1) These arpeggios can create complex notes and chords even when triggered by one note. 2) The arpeggio closely follows the notes played on the keyboard (only in the area where the arpeggio is assigned), allowing a good deal of harmonic freedom and the possibility to “solo” using these arpeggios.

Arpeggio type with “_XS” at the end of the type name (example: Rock1_XS)

These Arpeggios use a newly developed chord recognition technology to determine what notes should be played back by the Arpeggio. This XS type of arpeggio has the following benefits: 1) The arpeggios respond only to an area on the keyboard where an XS type of arpeggio is assigned. Other areas of the keyboard do not affect the chord recognition. This allows very natural keyboard playing across the entire keyboard with arpeggio generated bass and backing parts. 2) The arpeggio will always play harmonically correct parts. These are especially useful for bass and chordal backing parts.

Arpeggio type with a normal name (example: UpOct1)

In addition to the above types, there are three playback types: the Arpeggios created for use of Normal Voices and played back using only the played notes and their octave notes (page 15), the Arpeggios created for use of Drum Voices (page 16), and Arpeggios containing mainly non-note events (page 16).

Arpeggio type with “_AF1,” “_AF2,” or “_AF1&AF2” (example: Electro Pop AF1)

When this Type is triggered, the ASSIGNABLE FUNCTION [1] button, [2] button, or both buttons will be turned on during playback.

How to use the Arpeggio Type List

The Arpeggio Type list in the “Data List” PDF document contains the following columns.

1	2	3	4	5	6	7	8	9	10
Main Category	Sub Category	ARP No.	ARP Name	Time Signature	Length	Original Tempo	Accent	Random SFX	Voice Type
ApKb	Rock	1	MA_70s Rock_ES	4 / 4	2	130			Acoustic Piano
ApKb	Rock	2	MB_70s Rock_ES	4 / 4	1	130			:
ApKb	Rock	3	MC_70s Rock	4 / 4	2	130			
ApKb	Rock	4	MD_70s Rock	4 / 4	4	130			
ApKb	Rock	5	FA_70s Rock	4 / 4	1	130			
ApKb	Rock	6	FB_70s Rock_ES	4 / 4	1	130			
ApKb	Rock	7	FC_70s Rock_ES	4 / 4	2	130			

NOTE Note that this list is for illustration purposes only. For a complete listing of the Arpeggio Types, see the “Data List” PDF document.

1 Main Category

Indicates an Arpeggio Main Category.

2 Sub Category

Indicates an Arpeggio Sub Category.

3 ARP No (Arpeggio Number)

Indicates the Arpeggio type number.

4 ARP Name (Arpeggio Name)

Indicates the Arpeggio Name.

5 Time Signature

Indicates the time signature or meter of the Arpeggio type.

6 Length

Indicates the data length (amount of measures) of the Arpeggio type. When the Loop parameter ^{*1} is set to “off,” the Arpeggio plays back for this length and stops.

7 Original Tempo

Indicates the appropriate tempo value of the Arpeggio type. Note that this tempo is not set automatically when selecting an Arpeggio type.

8 Accent

The circle indicates that the Arpeggio uses the Accent Phrase feature (page 14).

9 Random SFX

The circle indicates that the Arpeggio uses the SFX feature (page 15).

10 Voice Type

Indicates the voice type appropriate for the Arpeggio Type. When the “VoiceWithARP” (Voice with Arpeggio) ^{*2} is set to “on” in the Song/Pattern Record, the voice of this type is automatically selected.

^{*1} The Loop parameter can be set in the PLAY FX display of Arpeggio Edit for Voice mode (page 28), Performance mode (page 58), and Song/Pattern mode (page 83).

^{*2} The “VoiceWithARP” parameter can be set in the MAIN display of the Arpeggio Edit for Song/Pattern mode (page 83).

Basic Structure

Functional blocks

Tone Generator block

A/D Input block

Sequencer block

▶ Arpeggio block

Controller block

Effect block

Internal memory

Reference

Voice mode

Performance mode

Song mode

Pattern mode

Mixing mode

Master mode

Remote mode

Utility mode

Quick setup

File mode

Using iOS Applications

Appendix

MIDI

Arpeggio related settings

There are several methods for triggering and stopping the Arpeggio playback. In addition, you can set whether or not SFX sounds and special Accent Phrases are triggered along with the normal sequence data. This section covers the Arpeggio related parameters which can be set in the Voice, Performance and Mixing modes.

Turning Arpeggio playback on/off

The following three settings are available for turning the Arpeggio playback on/off.

To play the Arpeggio only when the note is pressed:	Set the "Hold" parameter to "off" and the "TriggerMode" parameter to "gate."
To continue the Arpeggio even if the note is released:	Set the "Hold" parameter to "on" and the "TriggerMode" parameter to "gate."
To toggle the Arpeggio playback on/off whenever the note is pressed:	Set the "TriggerMode" parameter to "toggle." The "Hold" parameter can be set to either "on" or "off."

NOTE For the displays including the "Hold" and "TriggerMode" parameters, see MAIN display and PLAY FX display of the Arpeggio Edit for Voice mode (page 28), Performance mode (page 58), and Song/Pattern mode (page 83).

NOTE When receiving the MIDI sustain message (control change #64) with "Arp Sw" set to "on," you can obtain the same result by setting "Common Switch" and "Part Switch" to "on."

Using the knobs to control Arpeggios

When the ARP lamp is turned on by pressing the Knob Function 2 button a few times, you can use knobs 5 – 8 to control Arpeggio playback. Try this out and listen for the changes in the sound. For details regarding the effect of the knobs 5 – 8, see "Knob Functions" of the Voice mode (page 54).

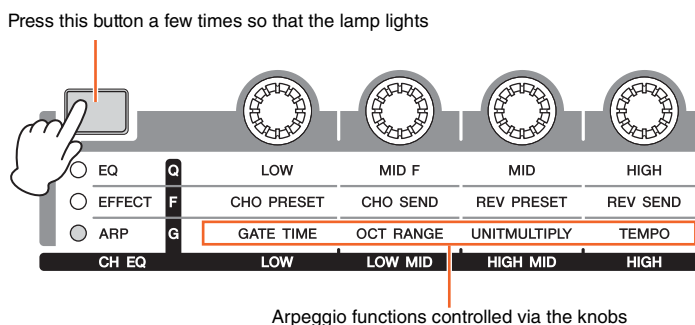

Accent Phrase

Accent Phrases are composed of sequence data included in some Arpeggio types, sounding only when you play notes at a velocity higher (stronger) than that specified in the Accent Velocity Threshold parameter. If it is hard to play at velocities necessary to trigger the Accent Phrase, set the "AccntVelTh" (Accent Velocity Threshold) parameter to a lower value.

NOTE For the displays including the "AccntVelTh" parameters, see PLAY FX display of the Arpeggio Edit for Voice mode (page 28), Performance mode (page 58), and Song/Pattern mode (page 83).

NOTE For information on Arpeggio types that use this function, refer to the "Arpeggio Type List" in the "Data List" PDF document.

Basic Structure

Functional blocks

Tone Generator block

A/D Input block

Sequencer block

▶ Arpeggio block

Controller block

Effect block

Internal memory

Reference

Voice mode

Performance mode

Song mode

Pattern mode

Mixing mode

Master mode

Remote mode

Utility mode

Quick setup

File mode

Using iOS Applications

Appendix

MIDI

Random SFX

Some Arpeggio types feature a Random SFX function which will trigger special sounds (such as guitar fret noises) when the note is released. The following parameters affecting Random SFX are provided.

For turning the Random SFX on/off:	Random SFX parameter
For setting the volume of the SFX sound:	SFXVelOffset (Random SFX Velocity Offset) parameter
For determining whether or not the volume of the SFX sound is controlled by velocity:	SFXKeyOnCtrl (Random SFX Key on Control) parameter

NOTE For the displays including the “RandomSFX,” “SFXVelOffset,” and “SFXKeyOnCtrl” parameters, see PLAY FX display of the Arpeggio Edit for Voice mode (page 28), for Performance mode (page 58), for Song/Pattern mode (page 83).

NOTE For information on Arpeggio types that use this function, refer to the “Arpeggio Type List” in the “Data List” PDF document.

Arpeggio setting displays

Each mode has one Arpeggio Edit display for the Arpeggio settings. If you press the ARP [EDIT] button in any of the modes, the Arpeggio Edit display will be shown.

Arpeggio playback types

There are three main Arpeggio playback types as described below.

Arpeggios for Normal Voices

Arpeggio types (belonging to all categories except for DrPC and Cntr) created for use of Normal Voices have the following three playback types.

Playback of played notes only

The Arpeggio is played back using only the played note(s) and octave notes.

Playback of a programmed sequence according to the played notes

These Arpeggio types have the several sequences each of which is suited for a certain chord type. Even if you press only one note, the Arpeggio is played back using the programmed sequence—meaning that notes other than the ones you play may be sounded. Pressing another note triggers a transposed sequence using the pressed note as the new root note. Adding notes to those already held changes the sequence accordingly. Arpeggios with this playback type have “_ES” at the end of the type name.

Playback of a programmed sequence according to the played chord

These Arpeggio types created for use with Normal Voices are played back to match the chord type determined by detecting the notes you play on the keyboard. Arpeggios with this playback type have “_XS” at the end of the type name.

NOTE When the “KeyMode” parameter is set to “sort” or “sortdirect,” the same sequence is played back no matter what order you play the notes. When the “KeyMode” parameter is set to “thru” or “thrudirect,” a different sequence is played back depending on the order you play the notes.

NOTE Since these types are programmed for Normal Voices, using them with Drum Voices may not produce musically appropriate results.

Basic Structure

Functional blocks

Tone Generator block

A/D Input block

Sequencer block

▶ Arpeggio block

Controller block

Effect block

Internal memory

Reference

Voice mode

Performance mode

Song mode

Pattern mode

Mixing mode

Master mode

Remote mode

Utility mode

Quick setup

File mode

Using iOS Applications

Appendix

MIDI

Arpeggios for Drum/Percussion Voices (Category: DrPc)

These Arpeggio types are programmed specifically for use with Drum Voices, giving you instant access to various rhythm patterns. Three different playback types are available.

Playback of a drum pattern

Pressing any note(s) will trigger the same rhythm pattern.

Playback of a drum pattern, plus additional played notes (assigned drum instruments)

Pressing any note will trigger the same rhythm pattern. Adding notes to the one already held produces additional sounds (assigned drum instruments) for the drum pattern.

Playback only of the played notes (assigned drum instruments)

Playing a note or notes will trigger a rhythm pattern using only the notes played (assigned drum instruments). Keep in mind that even if you play the same notes, the triggered rhythm pattern differs depending on the order of the notes played. This gives you access to different rhythm patterns using the same instruments simply by changing the order in which you play the notes, when the “KeyMode” parameter is set to “thru” or “thrudirect.”

NOTE The three playback types above are not distinguished by category name or type name. You'll have to actually play the types and hear the difference.

NOTE Since these types are programmed for Drum Voices, using them with Normal Voices may not produce musically appropriate results.

Arpeggios containing mainly non-note events (Category: Cntr)

These arpeggio types are programmed primarily with Control Change and Pitch Bend data. They are used to change the tone or pitch of the sound, rather than play specific notes. In fact, some types contain no note data at all. When using a type of this category, set the “KeyMode” parameter to “direct,” “thrudirect,” or “sortdirect.”

NOTE For the displays including the “KeyMode” parameters, see the PLAY FX display of the Arpeggio Edit for Voice mode ([page 28](#)), Performance mode ([page 58](#)), or for Song/Pattern mode ([page 83](#)).

Tips for Arpeggio playback

Arpeggios not only provide inspiration and full rhythmic passages over which you can perform, they give you quality MIDI data you can use in creating Songs, or fully formed backing parts to be used in your live performances. For instructions on using Arpeggio, see the “Quick Guide” in the Owner's Manual.

Basic Structure

Functional blocks

Tone Generator block

A/D Input block

Sequencer block

▶ Arpeggio block

Controller block

Effect block

Internal memory

Reference

Voice mode

Performance mode

Song mode

Pattern mode

Mixing mode

Master mode

Remote mode

Utility mode

Quick setup

File mode

Using iOS Applications

Appendix

MIDI

Controller Block

This block consists of the keyboard, Pitch Bend and Modulation Wheels, Ribbon Controller, Knobs, Sliders and so on. The keyboard itself doesn't generate sounds, but instead generates/transmits note on/off, velocity and other information (MIDI messages) to the synthesizer's tone generator block when you play notes. The controllers also generate/transmit MIDI messages. The synthesizer's tone generator block produces sound according to the MIDI messages transmitted from the keyboard and controllers.

Keyboard

The keyboard transmits the note on/off messages to the Tone Generator Block (for sounding) and Sequencer Block (for recording). The keyboard is also used for triggering Arpeggio playback. You can change the note range of the keyboard in octaves by using the OCTAVE [-]/[+] buttons, transpose the notes by using the TRANSPOSE [-]/[+] buttons, and set how the actual velocity is generated according to the strength with which you play notes.

Pitch Bend wheel

Use the Pitch Bend wheel to bend notes up (roll the wheel away from you) or down (roll the wheel toward you) while playing the keyboard. Roll the wheel upward/downward to bend the pitch upward/downward. This wheel is self-centering and will automatically return to normal pitch when released. Each preset Voice has its own default Pitch Bend Range setting. The Pitch Bend Range setting can be changed in the GENERAL display (page 30) of Voice Common Edit, the VOICE display (page 64) of Performance Part Edit, or the VOICE display (page 117) of Mixing Part Edit. From these displays you can also reverse the Pitch Bend function—so that moving the wheel up lowers the pitch, and moving it down raises the pitch. Functions other than Pitch Bend can be assigned to the Pitch Bend wheel in the CTL SET display (page 32) of Voice Edit.

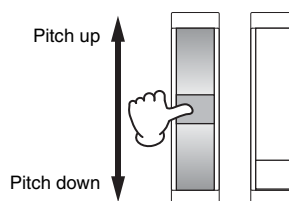

Modulation wheel

Even though the Modulation wheel is conventionally used to apply vibrato to the sound, many of the preset Voices have other functions and effects assigned to the wheel. The more you move this wheel up, the greater the effect that is applied to the sound. To avoid accidentally applying effects to the current Voice, make sure the Modulation wheel is set to minimum before you start playing. Various functions can be assigned to the Modulation wheel in the CTL SET display (page 32) of the Voice Common Edit.

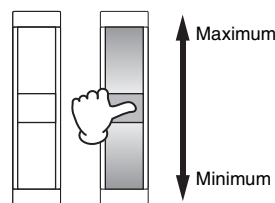

Assignable Function buttons

According to the XA (Expanded Articulation) Control settings in the OSC display (page 38) of Voice Element Edit, you can call up specific Elements of the current Voice by pressing each of these buttons during your keyboard performance. You can select how the on/off status of these buttons is switched by using the Assignable Function 1 Mode and Assignable Function 2 Mode parameters in the GENERAL display (page 30) of Voice Common Edit. Furthermore, you can assign various functions (other than calling up specific Elements) to these buttons in the CTL SET display (page 32) of Voice Edit.

Knobs

These eight knobs let you change various aspects of the Voice's sound in real time—while you play. The eight sliders let you adjust the volume of the Voice Elements, Performance Parts and Mixing Parts. For instructions on using the knobs in the Voice/Performance mode, see the Owner's Manual. For instructions on using the knobs in the Song/Pattern mode, see page 124.

Basic Structure

Functional blocks
Tone Generator block
A/D Input block
Sequencer block
Arpeggio block
▶ Controller block
Effect block
Internal memory

Reference

Voice mode
Performance mode
Song mode
Pattern mode
Mixing mode
Master mode
Remote mode
Utility mode
Quick setup
File mode

Using iOS Applications

Appendix

MIDI

DAW Remote

Press the [DAW REMOTE] to enter the Remote mode. Entering the Remote mode will change the functions of the panel buttons—with the exception of the A/D INPUT [ON/OFF], OCTAVE [-]/[+], TRANSPOSE [-]/[+] and [UTILITY] buttons—to those exclusive to this mode. For details, see the Remote mode of the "Reference" section on page 133.

Effect Block

This block applies effects to the output of the tone generator block as well as audio input block, processing and enhancing the sound. Effects are applied in the final stages of editing, letting you change the sound as desired.

Effect structure

System Effects – Reverb and Chorus

System Effects are applied to the overall sound. With System Effects, the sound of each Part is sent to the effect according to the Effect Send Level for each Part. The processed sound (referred to as “wet”) is sent back to the mixer according to the Return Level, and output—after being mixed with the unprocessed “dry” sound. This instrument is equipped with Reverb and Chorus as System Effects. In addition, you can set the Send Level from Chorus to Reverb. This parameter is used to apply Reverb to the signals output from the Chorus. You can get a natural effect by applying Reverb depth to the Chorus sound with the same level as that of the dry sound.

Insertion Effects

Insertion Effects can be applied individually to each of specified parts before merging signals of all parts. It should be used for sounds for which you want to drastically change the character. Each Voice features one set which has A and B units. You can set different Effect types to the Insertion Effects A and B, or apply one Vocoder effect to Insertion Effects A and B. These settings can be set in the CONNECT display (page 35) of the Voice Common Edit.

This synthesizer features eight sets of Insertion Effects (one set has A and B units). They can be applied to all Parts of the Performance, and applied to eight Parts (maximum) of the Song/Pattern. Another important Insertion Effect is the Vocoder, which can be applied only to one Part.

Master Effect

This block applies effects to the final stereo output signal of the entire sound. Multiple Effect types are available.

Element EQ

Element EQ is applied to each Element of the Normal Voice and each key of the Drum Voice. You can specify one of three different EQ shapes, including shelving and peaking.

NOTE Element EQ does not affect the Input signals from the A/D INPUT [L]/[R] jacks.

Part EQ/Common EQ

This 3-band parametric EQ is applied to each part of the Performance/Mixing. The high band and low band are of the shelving type. The middle band is the peaking type. The Common EQ parameters offset the settings of the Part EQ parameters.

NOTE Part EQ and Common EQ do not affect the Input signals from the A/D INPUT [L]/[R] jacks.

Master EQ

Master EQ is applied to the final (post-effect), overall sound of the instrument. In this EQ, all five bands can be set to peaking, with shelving being available also for the lowest and highest bands.

Basic Structure

Functional blocks

Tone Generator block

A/D Input block

Sequencer block

Arpeggio block

Controller block

▶ Effect block

Internal memory

Reference

Voice mode

Performance mode

Song mode

Pattern mode

Mixing mode

Master mode

Remote mode

Utility mode

Quick setup

File mode

Using iOS Applications

Appendix

MIDI

Effect connection in each mode

In the Voice mode

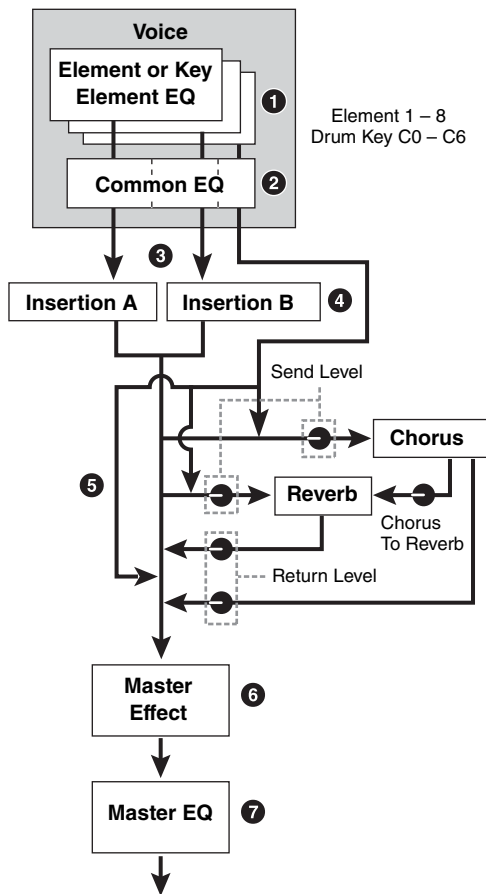

1 Element EQ applied to each Element (for a Normal Voice) and each Key (for a Drum Voice)

Settings: Can be set in the EQ display (pages 46 and 51) of Voice Element Edit/Voice Key Edit.

2 Common EQ applied to all Elements and Keys

Settings: Set in the EQ display (page 32) of Voice Common Edit.

3 Selection of which Insertion Effect, A or B, is applied to each Element/Key

Settings: Set in "EL: OUT" (page 35) or "KEY: OUT" (page 48) in the EFFECT display of Voice Common Edit, or set in "InsEffectOut" (page 39) in the OSC display of Voice Element Edit (or Key Edit).

NOTE These two display types are linked and feature the same settings, only in different formats.

4 Insertion Effect A/B related parameters

Settings: Set in the CONNECT display (page 35) and the INSA display/INSB display (page 36) of Voice Common Edit.

5 Reverb and Chorus related parameters

Settings: Set in the CONNECT display (page 35) and the CHORUS display/REVERB display (page 36) of Voice Common Edit.

6 Master Effect related parameters

Settings: Set in the MFX display (page 143) of the Utility mode.

7 Master EQ related parameters

Settings: Set in the MEQ display (page 143) of the Utility mode.

NOTE Regarding the audio input signal from the A/D INPUT [L]/[R] jacks in the Voice mode, the effect is set in the VCE A/D display of the Utility mode. First, set the Insertion Effects. Then, making sure "Mode" (page 146) is set to "1StereoRec" in the USB I/O display of the Utility mode, set the level of the signal sent to Chorus and Reverb. When "Mode" is set to "VST" or "2StereoRec," the signal which is output from the Insertion Effect will be directly output to the USB [TO HOST] terminal or OUTPUT [L/MONO]/[R] jacks.

Basic Structure

Functional blocks

Tone Generator block

A/D Input block

Sequencer block

Arpeggio block

Controller block

▶ Effect block

Internal memory

Reference

Voice mode

Performance mode

Song mode

Pattern mode

Mixing mode

Master mode

Remote mode

Utility mode

Quick setup

File mode

Using iOS Applications

Appendix

MIDI

In the Performance mode

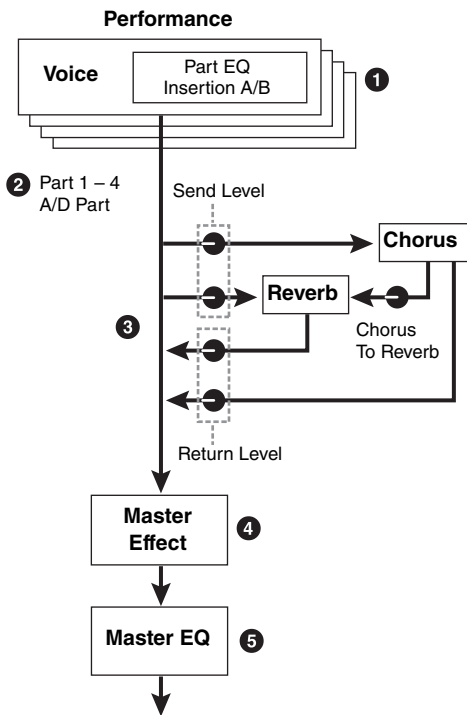

- 1 Part EQ applied to each Part**
Settings: Set in the EQ display (page 67) of Performance Part Edit.
- 2 Selection of the Parts to which the Insertion Effect is applied**
Settings: Set in the INS SW display (page 64) of Performance Common Edit.
- 3 Reverb and Chorus related parameters**
Settings: Set in the CONNECT display (page 63), CHORUS display and REVERB display (page 64) of Performance Common Edit, and the EF SEND display (page 66) of Performance Part Edit.
- 4 Master Effect related parameters**
Settings: Set in the MFX display (page 60) of Performance Common Edit.
- 5 Master EQ related parameters**
Settings: Set in the MEQ display (page 61) of Performance Common Edit.

NOTE Regarding the audio input signal from the A/D INPUT [L]/[R] jacks in the Performance mode, the effect is set in the A/D IN display of Performance Common Edit. First, set the Insertion Effects. Then, making sure that "Mode" (page 146) is set to "1StereoRec" in the USB I/O display of the Utility mode, set the level of the signal sent to Chorus and Reverb. When "Mode" is set to "VST" or "2StereoRec," the signal which is output from the Insertion Effect will be directly output to the USB [TO HOST] terminal or OUTPUT [L/MONO]/[R] jacks.

In the Mixing mode

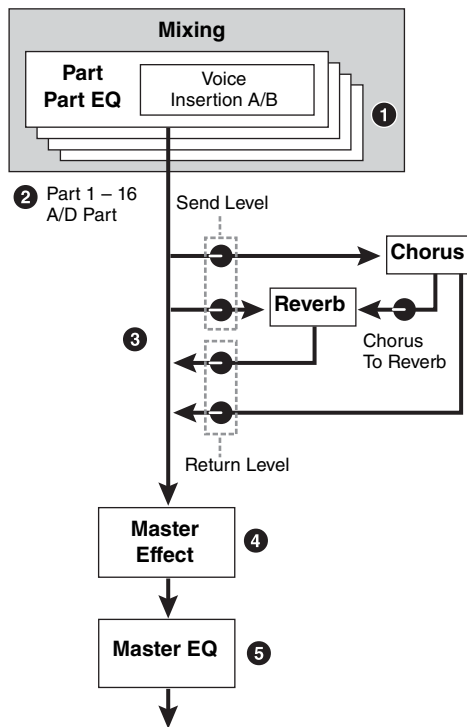

- 1 Part EQ applied to each Part**
Settings: Set in the EQ display (page 118) of Mixing Part Edit.
- 2 Selection of the Parts to which the Insertion Effect is applied**
Settings: Set in the EFFECT display (page 116) of Mixing Common Edit.
- 3 Reverb and Chorus related parameters**
Settings: Set in the EFFECT display (page 116) of Mixing Common Edit.
- 4 Master Effect related parameters**
Settings: Set in the MFX display (page 116) of Mixing Common Edit.
- 5 Master EQ related parameters**
Settings: Set in the MEQ display (page 116) of Mixing Common Edit.

NOTE Regarding the audio input signal from the A/D INPUT [L]/[R] jacks in the Song/Pattern mode, the effect is set in the A/D IN display of the Mixing Common Edit. First, set the Insertion Effects. Then, making sure that "Mode" (page 146) is set to "1StereoRec" in the USB I/O display of the Utility mode, set the level of the signal sent to Chorus and Reverb. When "Mode" is set to "VST" or "2StereoRec," the signal which is output from the Insertion Effect will be directly output to the USB [TO HOST] terminal or OUTPUT [L/MONO]/[R] jacks.

Basic Structure

Functional blocks
Tone Generator block
A/D Input block
Sequencer block
Arpeggio block
Controller block
▶ Effect block
Internal memory

Reference

Voice mode
Performance mode
Song mode
Pattern mode
Mixing mode
Master mode
Remote mode
Utility mode
Quick setup
File mode

Using iOS Applications

Appendix

MIDI

About the Vocoder Effect

MOXF6/MOXF8 features a Vocoder effect. Vocoder is a distinctive, “robot voice” effect which extracts the characteristic of the microphone sound and adds it to the sound via your keyboard performance. The human voice consists of sounds generated from the vocal cords, and filtered by the throat, nose and mouth. These resonant sections have specific frequency characteristics and they function effectively as a filter, creating many formants (harmonic content). The Vocoder effect extracts the filter characteristics of the voice from the microphone input and recreates the vocal formants by the use of multiple band pass filters. The machine-like ‘robot’ voice is created by passing the pitched sounds of musical instruments (such as a synthesizer sound) through the filters. For instructions on using the Vocoder effect, see the Owner’s Manual.

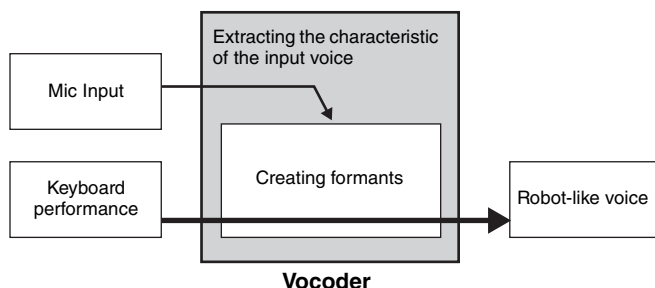

About Effect categories, Effect types, and Effect parameters

For information regarding the effect categories of this instrument and the effect types contained in their categories, see the “Effect Type List” in the “Data List” PDF document. For information on the effect parameters which can be set in the each effect type, see the “Effect Parameter List” in the “Data List” PDF document. For information on the descriptions of each effect category, each effect type, and each effect parameter, see the “Synthesizer Parameters Manual” PDF documentation.

About Preset settings

Preset settings for parameters of each effect type are provided as templates and can be selected in the Effect Type selection display. To get a desired effect sound, try first selecting one of the Presets close to your imagined sound, then change the parameters as necessary. Preset settings can be determined by setting “Preset” in each effect parameter display. For information on each effect type, see the “Data List” PDF document.

Basic Structure

Functional blocks

Tone Generator block

A/D Input block

Sequencer block

Arpeggio block

Controller block

▶ Effect block

Internal memory

Reference

Voice mode

Performance mode

Song mode

Pattern mode

Mixing mode

Master mode

Remote mode

Utility mode

Quick setup

File mode

Using iOS Applications

Appendix

MIDI

Internal Memory

The MOXF6/MOXF8 creates a variety of different kinds of data, including Voice, Performance, Song, and Pattern. This section describes how to maintain the various types of data and use the memory devices/media for storing them.

Internal memory of the MOXF6/MOXF8

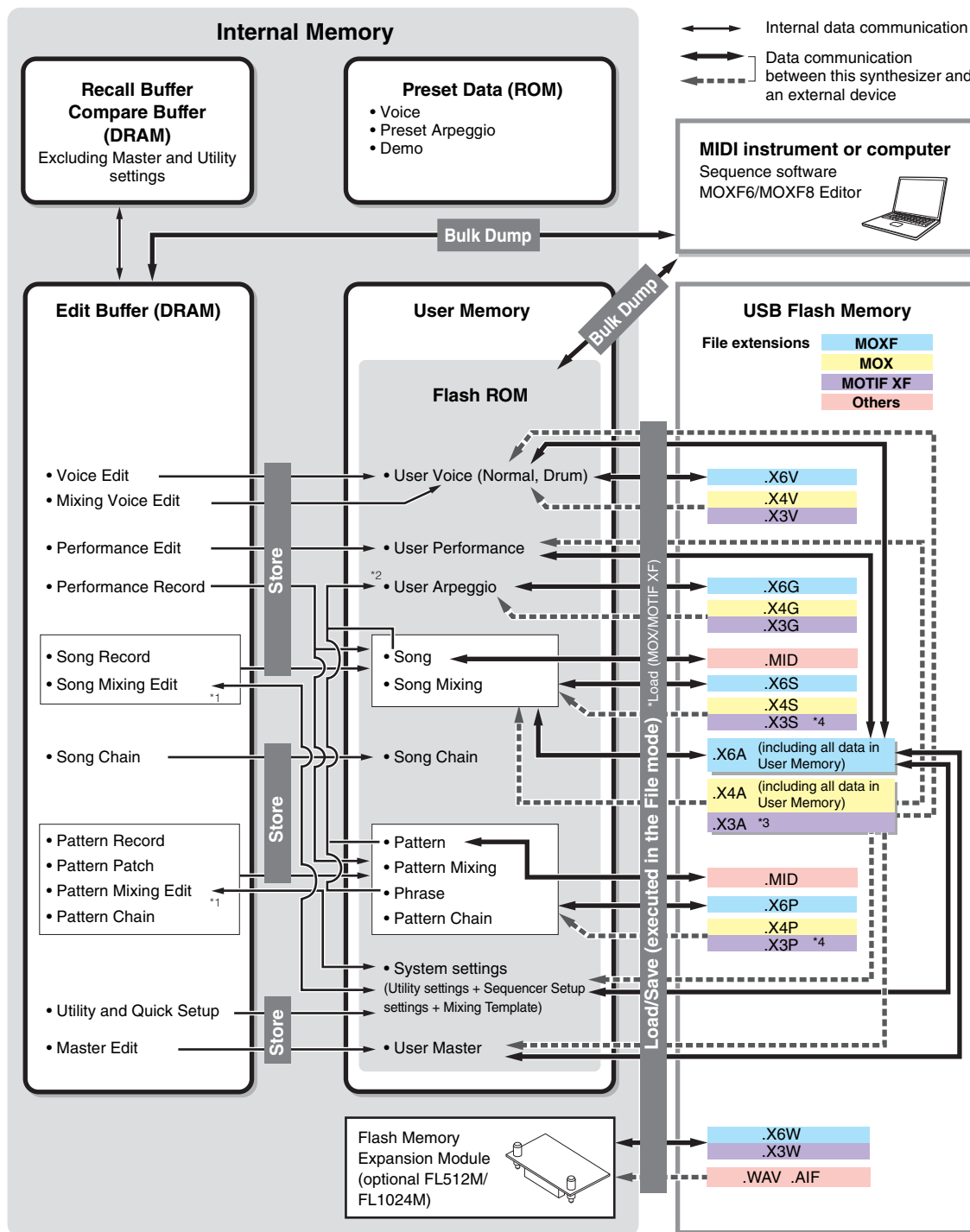

*1 The Mixing settings can be stored/recalled as a template in the Song Mixing Job/Pattern Mixing Job.

*2 You can convert the MIDI sequence data recorded in the Song Record/Pattern Record to Arpeggio data. This can be executed with the following operations: [SONG] → [JOB] → [F5] Track → 07: Put Track to Arpeggio or [PATTERN] → [JOB] → [F5] Track → 07: Put Track to Arpeggio

*3 Only Voice, Performance, Arpeggio, Mixing Template, and Waveform data.

*4 Only Waveform data.

Basic Structure

Functional blocks
Tone Generator block
A/D Input block
Sequencer block
Arpeggio block
Controller block
Effect block
Internal memory

Reference

Voice mode
Performance mode
Song mode
Pattern mode
Mixing mode
Master mode
Remote mode
Utility mode
Quick setup
File mode

Using iOS Applications

Appendix

MIDI

Flash ROM

ROM (Read Only Memory) is memory designed specifically for reading out data, and as such data cannot be written to it. Unlike conventional ROM, Flash ROM can be overwritten—allowing you to store your own original data. The contents of Flash ROM are maintained even when the power is turned off.

DRAM

RAM (Random Access Memory) is memory designed specifically for data writing and data reading operations. There are two different kinds of RAM, depending on the condition for storing the data: SRAM (Static RAM) and DRAM (Dynamic RAM). The MOXF6/MOXF8 is equipped with only DRAM. Because data contained in DRAM is lost when the power is turned off, you should always store any data residing in DRAM to the Flash ROM or a USB flash memory before turning off the power.

Flash Memory Expansion Module (optional FL512M/FL1024M)

The samples that you make can be stored as Waveforms by installing the optional Flash Memory Expansion Module FL512M/FL1024M to the MOXF. Samples on the Flash Memory Expansion Module will be maintained even if the power is turned off and can immediately be called up as Waveforms. This is convenient when using a User Voice containing a Waveform.

NOTE The optional FL512M/FL1024M can handle only Waveform data.

Edit buffer & User memory

The edit buffer is the memory location for edited data of these types: Voice, Performance, Master, Song Mixing, and Pattern Mixing. Data edited in this location will be stored to the User Memory. In Voice/Performance/Master/Mixing mode, the edit buffer is the memory location only for one program. Therefore, if you select another Voice, Performance, Master, Song, or Pattern, the entire contents of the edit buffer will be rewritten with the newly selected Voice/Performance/Mixing data. Make sure to store any important data before selecting another Voice, etc. In Song/Pattern mode, the edit buffer for the sequencer settings is the memory location for the entire programs of both modes (64 x 2). Therefore, even if you select another mode (Song mode or Pattern mode) or another Song or Pattern, the sequence data of old Songs/Patterns will be kept. Make sure to store the sequence data before turning off the power, because the kept sequence data will be lost when the power is turned off. If you store the sequence data, all Song data and all Pattern data including the Mixing settings will be stored to User memory.

Edit buffer and Recall buffer

If you've selected another Voice/Performance/Song/Pattern without storing the one you were editing, you can recall your original edits, since the edit buffer's contents are stored on backup memory. If you've selected another Voice/Performance/Song/Pattern without storing the one you were editing, you can recall your original edits.

NOTE Keep in mind that the recall buffer is not available in the Master Edit mode.

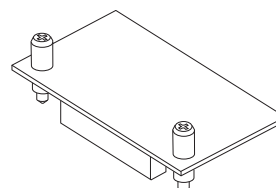

Basic Structure

Functional blocks
Tone Generator block
A/D Input block
Sequencer block
Arpeggio block
Controller block
Effect block
▶ Internal memory

Reference

Voice mode
Performance mode
Song mode
Pattern mode
Mixing mode
Master mode
Remote mode
Utility mode
Quick setup
File mode

Using iOS Applications

Appendix

MIDI

Reference

This section provides a detailed description of the parameters used to configure your MOXF6/MOXF8.

Display's Basic Configuration

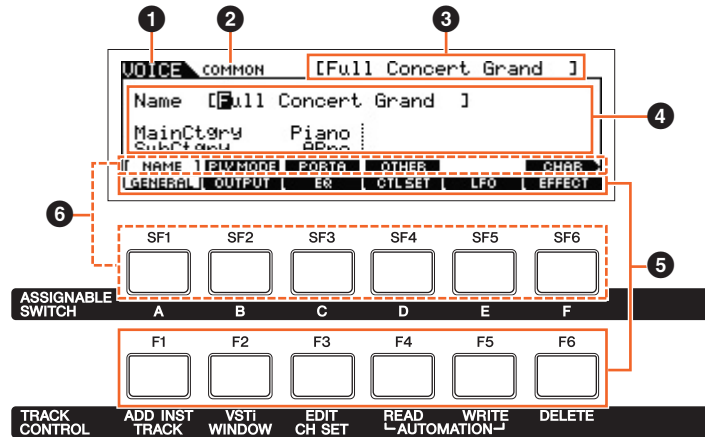

- ❶ Indicates the selected Track.
- ❷ Indicates the current edit status; for example, Common edit or Part edit.
- ❸ Indicates the Voice/Performance/Song/Pattern/Master that is currently selected for editing.
- ❹ Indicates the currently editable parameters.
- ❺ Indicates the various displays categorized by function in tab format. Pressing the [F1] – [F6] (Function button) allows you to jump to the display for the corresponding function.
- ❻ Indicates the various displays categorized by the sub function in tab format (when the tab you selected in ❺ above has sub functions). Pressing the [SF1] – [SF6] (Sub Function button) allows you to jump to the display for the corresponding sub function.

About the icons

In the Reference section, the parameters marked by this icon can be changed directly via the appropriate Knob on the panel.

Voice Mode

The Voice mode is used for selecting, playing, and editing desired Voices. This section explains each parameter in the four types (Voice Play, Normal Voice Edit, Drum Voice Edit, and Voice Job). Note that available parameters for editing differ depending on the Voice types (Normal Voice and Drum Voice).

Voice Play

Voice Play is the main “portal” by which you enter the Voice mode, and it is here where you select and play a Voice. Some of the Voice settings can also be edited in this mode.

Operation

Press the [VOICE] button.

[F1] PLAY

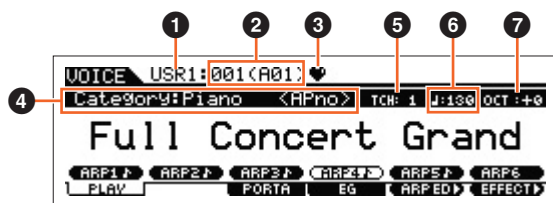

Voice Play display

1 Voice Bank

2 Voice Number

Indicates the currently selected Voice bank and Voice number.

3 Favorite Category indicator

When assigning the currently selected Voice to the Favorite category, this indicator will appear.

4 Category

Indicates the Main category and Sub category of the currently selected Voice.

5 TCH (Transmit Channel)

Indicates the Keyboard MIDI transmit channel. You can change the Keyboard MIDI transmit channel by pressing the [TRACK] button so that its indicator lights and pressing any of the Number [1] – [16] buttons. The Keyboard MIDI transmit channel can be changed also with the following operation: [UTILITY] → [F6] MIDI → [SF1] CH → “KBDTransCh.”

6 J (Arpeggio Tempo)

Indicates the Arpeggio tempo set for the currently selected Voice.

NOTE This parameter can be set also by holding the [SHIFT] button and pressing the [ENTER] button several times repeatedly at the desired tempo. This function is referred to as “Tap Tempo.”

7 OCT (Octave)

Indicates the Keyboard Octave setting.

[SF1] ARP1 (Arpeggio 1) – [SF6] ARP6 (Arpeggio 6)

The Arpeggio types are assigned to the buttons with 8th note icons on the display tab. You can call them up by pressing these buttons any time during your keyboard performance. The Arpeggio Type can be set in the Arpeggio Edit display (page 27).

Voice Mode

Voice Play

- ▶ [F1] PLAY
- [F3] PORTA
- [F4] EG
- [F5] ARP ED
- [F6] EFFECT

Arpeggio Edit

- [F2] TYPE
- [F3] MAIN
- [F4] LIMIT
- [F5] PLAY FX

Normal Voice Edit

Common Edit

- [F1] GENERAL
- [F2] OUTPUT
- [F3] EQ
- [F4] CTL SET
- [F5] LFO
- [F6] EFFECT

Element Edit

- [F1] OSC
- [F2] PITCH
- [F3] FILTER
- [F4] AMP
- [F5] LFO
- [F6] EQ

Drum Voice Edit

Common Edit

- [F1] GENERAL
- [F2] OUTPUT
- [F3] EQ
- [F4] CTL SET
- [F6] EFFECT

Key Edit

- [F1] OSC
- [F2] PITCH
- [F3] FILTER
- [F4] AMP
- [F6] EQ

Voice Job

- [F1] INIT
- [F2] RECALL
- [F3] COPY
- [F4] BULK

Supplementary Information

[F3] PORTA (Portamento)

From this display you can select monophonic or polyphonic playback and set the Portamento parameters. The setting made here will be applied to the same parameter in Voice Common Edit.

NOTE When a Drum Voice is selected, the Portamento parameters are not available.

Mono/Poly

Selects monophonic or polyphonic.

Settings: mono, poly

PortaSW (Portamento Switch) Knob

Determines whether Portamento is applied to the current Voice or not.

Settings: off, on

PortaTime (Portamento Time) Knob

Determines the pitch transition time or rate when Portamento is applied.

Settings: 0 – 127

PortaMode (Portamento Mode)

Determines how Portamento is applied to your keyboard performance. For details on settings, see the “Synthesizer Parameter Manual” PDF document.

Settings: fingered, fulltime

[F4] EG (Envelope Generator)

In this section, set the offset value for the Amplitude EG and Filter EG of all Elements that make up the Voice.

AEG (Amplitude EG) Knob

ATK (Attack Time)

Determines how quickly the sound reaches its maximum level after a key is pressed.

DCY (Decay Time)

Determines how fast the volume falls from maximum attack level to the sustain level.

SUS (Sustain Level)

Determines the sustain level at which the volume will continue while a note is held, after the initial attack and decay.

REL (Release Time)

Determines how quickly the sound decays to silence after the key is released.

Settings: -64 – +0 – +63

NOTE When a Drum Voice is selected, the Sustain Level and Release Time are not available. “---” appears at each of the corresponding columns and these parameters cannot be edited.

FEG (Filter EG)

ATK (Attack Time)

Determines the speed of filter variation from the time a note is played until the maximum initial level of the Cutoff Frequency is reached.

DCY (Decay Time)

Determines how fast the Cutoff Frequency falls from maximum attack level to the sustain level.

REL (Release Time)

Determines how fast the Cutoff Frequency falls from the sustain level to zero when a note is released.

DEPTH Knob

Determines the range over which the cutoff frequency of the Filter EG changes.

CUTOFF (Cutoff) Knob

Determines the Cutoff Frequency for the Filter. When the Low Pass Filter is selected, for example, the larger the value the brighter the decay.

RESO (Resonance) Knob

Determines the emphasis given to the Cutoff Frequency.

Settings: -64 – +0 – +63

Voice Mode

Voice Play

- [F1] PLAY
- ▶ [F3] PORTA
- ▶ [F4] EG
- [F5] ARP ED
- [F6] EFFECT

Arpeggio Edit

- [F2] TYPE
- [F3] MAIN
- [F4] LIMIT
- [F5] PLAY FX

Normal Voice Edit

Common Edit

- [F1] GENERAL
- [F2] OUTPUT
- [F3] EQ
- [F4] CTL SET
- [F5] LFO
- [F6] EFFECT

Element Edit

- [F1] OSC
- [F2] PITCH
- [F3] FILTER
- [F4] AMP
- [F5] LFO
- [F6] EQ

Drum Voice Edit

Common Edit

- [F1] GENERAL
- [F2] OUTPUT
- [F3] EQ
- [F4] CTL SET
- [F6] EFFECT

Key Edit

- [F1] OSC
- [F2] PITCH
- [F3] FILTER
- [F4] AMP
- [F6] EQ

Voice Job

- [F1] INIT
- [F2] RECALL
- [F3] COPY
- [F4] BULK

Supplementary Information

[F5] ARP ED (Arpeggio Edit)

Indicates the Arpeggio Edit display (page 27) in the Voice mode.

[F6] EFFECT

Indicates the EFFECT display (page 35) of Voice Common Edit.

Arpeggio Edit

Sets the Arpeggio-related parameters. Press the [SF1] ARP1 – [SF6] ARP6 in the each display to select the Arpeggio for editing.

Operation

[VOICE] → Voice selection → [F5] ARP ED
Voice mode → ARP [EDIT]

[F2] TYPE

Bank (Arpeggio Bank)

Category (Arpeggio Category)

SubCategory (Arpeggio Sub Category)

Type (Arpeggio Type)

Determines the desired Arpeggio Type number from the specified Bank and Category.

Settings: Bank pre (preset), user
Category/SubCategory See the Category List (page 11).
Type See the "Data List" PDF document.

VeloRateOfs (Velocity Rate Offset)

Determines the offset value for the Velocity Rate of Arpeggio playback. If the resultant velocity value is less than zero it will be set to 1, and if the resultant velocity is greater than 128 it will be set to 127.

Settings: -100% – +0% – +100%

GateRateOfs (Gate Time Rate Offset)

Determines the offset value for the Gate Time Rate of Arpeggio playback. The Gate Time cannot be decreased beyond its normal minimum of 1; any values outside that range will automatically be limited to the minimum.

Settings: -100% – +0% – +100%

[F3] MAIN

Tempo (Arpeggio Tempo) Knob

Determines the Arpeggio Tempo.

Settings: 5 – 300

NOTE If you are using this instrument with an external sequencer, DAW software, or MIDI device, and you want to synchronize it with that device, set the "MIDI Sync" parameter (page 148) in the MIDI display of the Utility mode to "external" or "auto." When "MIDI Sync" is set to "auto" (only when MIDI clock is transmitted continuously) or "external," the Tempo parameter here indicates "external" and cannot be changed.

NOTE This parameter can be set also by holding the [SHIFT] button and pressing the [ENTER] button several times repeatedly at the desired tempo. This function is referred to as "Tap Tempo."

Switch (Arpeggio Switch)

Determines whether Arpeggio is on or off.

Settings: off, on

Hold (Arpeggio Hold)

Determines whether the Arpeggio continues cycling after the keys are released. For details on settings, see the "Synthesizer Parameter Manual" PDF document.

Settings: sync-off, off, on

Voice Mode

Voice Play

[F1] PLAY
[F3] PORTA
[F4] EG
▶ [F5] ARP ED
▶ [F6] EFFECT

Arpeggio Edit

▶ [F2] TYPE
▶ [F3] MAIN
[F4] LIMIT
[F5] PLAY FX

Normal Voice Edit

Common Edit

[F1] GENERAL
[F2] OUTPUT
[F3] EQ
[F4] CTL SET
[F5] LFO
[F6] EFFECT

Element Edit

[F1] OSC
[F2] PITCH
[F3] FILTER
[F4] AMP
[F5] LFO
[F6] EQ

Drum Voice Edit

Common Edit

[F1] GENERAL
[F2] OUTPUT
[F3] EQ
[F4] CTL SET
[F6] EFFECT

Key Edit

[F1] OSC
[F2] PITCH
[F3] FILTER
[F4] AMP
[F6] EQ

Voice Job

[F1] INIT
[F2] RECALL
[F3] COPY
[F4] BULK

Supplementary Information

ChgTiming (Change Timing)

Determines the actual timing at which the Arpeggio type is switched when you select another type during Arpeggio playback. When set to “realtime,” the Arpeggio type is switched immediately. When set to “measure,” the Arpeggio type is switched at the top of the next measure.

Settings: realtime, measure

KeyMode

Determines how the Arpeggio plays back when playing the keyboard. For details on settings, see the “Synthesizer Parameter Manual” PDF document.

Settings: sort, thru, direct, sortdirect, thruirect

NOTE Some Arpeggio types belonging to the “Cntr” Category may not have note events (page 16). When such an Arpeggio type is selected and “KeyMode” is set to “sort” or “thru,” no sound is produced, even if the MOXF6/MOXF8 receives Note On messages.

VelMode (Velocity Mode)

Adjusts the velocity of the Arpeggio notes.

Settings: original, thru

OutOctShift (Output Octave Shift)

Shifts the pitch of the Arpeggio up or down in octaves.

Settings: -10 – +0 – +10

[F4] LIMIT

NoteLimit (Arpeggio Note Limit)

Determines the lowest and highest notes in the Arpeggio's note range.

Settings: C -2 – G8

VelocityLimit (Arpeggio Velocity Limit)

Determines the lowest and highest velocity which can trigger Arpeggio playback.

Settings: 1 – 127

[F5] PLAY FX (Play Effect)

Swing

Delays notes on even-numbered beats (backbeats) to produce a swing feel.

Settings: -120 – +0 – +120







UnitMultiply Knob

Adjusts the Arpeggio playback time based on tempo.

Settings: 50%, 66%, 75%, 100%, 133%, 150%, 200%

QtzValue (Quantize Value)

Determines to which beats the note data in the Arpeggio will be aligned, or to which beats in the Arpeggio swing is applied. The number shown at right of each value indicates the resolution of quarter notes in clocks.

Settings:  60 (32nd note),  80 (16th note triplet),  120 (16th note),  160 (8th note triplet),  240 (8th note),  320 (1/4 note triplet),  480 (1/4 note)

QtzStrength (Quantize Strength)

Sets the “strength” by which note events are pulled toward the nearest quantize beats.

Settings: 0% – 100%

VelocityRate

Determines how much the velocity of Arpeggio playback is offset from the original value.

Settings: 0% – 200%

GateTimeRate Knob

Determines how much the Gate Time (length) of the Arpeggio notes is offset from the original value.

Settings: 0% – 200%

Voice Mode

Voice Play

[F1] PLAY
[F3] PORTA
[F4] EG
[F5] ARP ED
[F6] EFFECT

Arpeggio Edit

[F2] TYPE
▶ [F3] MAIN
▶ [F4] LIMIT
▶ [F5] PLAY FX

Normal Voice Edit

Common Edit

[F1] GENERAL
[F2] OUTPUT
[F3] EQ
[F4] CTL SET
[F5] LFO
[F6] EFFECT

Element Edit

[F1] OSC
[F2] PITCH
[F3] FILTER
[F4] AMP
[F5] LFO
[F6] EQ

Drum Voice Edit

Common Edit

[F1] GENERAL
[F2] OUTPUT
[F3] EQ
[F4] CTL SET
[F6] EFFECT

Key Edit

[F1] OSC
[F2] PITCH
[F3] FILTER
[F4] AMP
[F6] EQ

Voice Job

[F1] INIT
[F2] RECALL
[F3] COPY
[F4] BULK

Supplementary Information

OctaveRange  Knob

Specifies the maximum Arpeggio range in octaves.

Settings: -3 – +0 – +3

Loop

Determines whether the Arpeggio plays through a single time or continuously, while notes are held.

Settings: off, on

TriggerMode

When this is set to “gate,” pressing the note starts Arpeggio playback and releasing the note stops it. When this is set to “toggle,” pressing the note starts/stops Arpeggio playback and releasing the note does not affect Arpeggio playback.

Settings: gate, toggle

AccntVelTh (Accent Velocity Threshold)

Determines the minimum velocity that will trigger the Accent Phrase.

Settings: off, 1 – 127

AccntStrtQtz (Accent Start Quantize)

Determines the start timing of the Accent Phrase when the Velocity specified in Accent Velocity Threshold above is received. When this is set to off, the Accent Phrase starts as soon as the Velocity is received. When this is set to on, the Accent Phrase starts on the beat specified for each Arpeggio type after the Velocity is received.

Settings: off, on

RandomSFX

Determines whether Random SFX is active or not.

Settings: off, on

SFXVelOffset (Random SFX Velocity Offset)

Determines the offset value by which the Random SFX notes will be shifted from their original velocities.

Settings: -64 – +0 – +63

SFXKeyOnCtrl (Random SFX Key on Control)

When this is set to “on,” a special Random SFX sound is played at a pre-programmed velocity. When this is set to “off,” the Random SFX sound is played at the velocity generated by the playing of each note.

Settings: off, on

Fixed SD/BD

This parameter is available only when a Drum Voice is assigned. When this parameter is set to on, C1 will be used as the note of the Bass Drum and D1 will be used as the note of the Snare Drum in Arpeggio playback.

Settings: off, on

Voice Mode**Voice Play**

[F1] PLAY
[F3] PORTA
[F4] EG
[F5] ARP ED
[F6] EFFECT

Arpeggio Edit

[F2] TYPE
[F3] MAIN
[F4] LIMIT
▶ [F5] PLAY FX

Normal Voice Edit**Common Edit**

[F1] GENERAL
[F2] OUTPUT
[F3] EQ
[F4] CTL SET
[F5] LFO
[F6] EFFECT

Element Edit

[F1] OSC
[F2] PITCH
[F3] FILTER
[F4] AMP
[F5] LFO
[F6] EQ

Drum Voice Edit**Common Edit**

[F1] GENERAL
[F2] OUTPUT
[F3] EQ
[F4] CTL SET
[F6] EFFECT

Key Edit

[F1] OSC
[F2] PITCH
[F3] FILTER
[F4] AMP
[F6] EQ

Voice Job

[F1] INIT
[F2] RECALL
[F3] COPY
[F4] BULK

Supplementary Information

Normal Voice Edit

A Normal Voice, which contains pitched musical instrument-type sounds that can be played over the range of the keyboard, can consist of up to eight Elements. There are two types of Normal Voice Edit displays: those for Common Edit to edit the settings common to all Elements, and those for Element Edit to edit individual Elements. This section explains the parameters for Common Edit and Element Edit.

Common Edit

Operation

[VOICE] → Normal Voice selection → [EDIT] → [COMMON]

[F1] GENERAL

[SF1] NAME

Name (Voice Name)

Enters the desired name for the Voice. If you press the [SF6] CHAR when the cursor is located at "Name," the name dialog will be displayed. Voice names can contain up to 20 characters. You can set the name by using the [DATA] dial and Cursor [<]/[>] buttons while holding the [SF6] CHAR button. For detailed instructions on naming, see the "Basic Operation" section of the Owner's Manual.

MainCtgr (Main Category)

SubCtgr (Sub Category)

Determines the Main Category and Sub Category of the Voice. The categories are keywords representing the general characteristics of the Voices. Selecting the appropriate category makes it easy to find the desired Voice from the huge variety of Voices available. There are 17 Main Categories which indicate types of instruments. There are up to six Sub Categories for each Main Category, indicating more detailed types of instruments.

Settings: See the "Voice Category List" on [page 53](#).

[SF2] PLY MODE (Play Mode)

Mono/Poly

Selects monophonic or polyphonic.

For details on settings, see the "Synthesizer Parameter Manual" PDF document.

Settings: mono, poly

KeyAsgnMode (Key Assign Mode)

Determines the playing method when the same notes are received continuously over the same channel, and without corresponding note off messages. For details on settings, see the "Synthesizer Parameter Manual" PDF document.

Settings: single, multi

NoteShift

Determines the transpose setting for the amount (in semitones) by which the pitch is raised or lowered.

Settings: -24 – +0 – +24

M. TuningNo. (Micro Tuning Number)

Determines the tuning system for the Voice. For information on the various tuning systems, see the "Synthesizer Parameter Manual" PDF document.

Settings: 01 (Equal Temp), 02 (PureMaj), 03 (PureMin), 04 (Werckmeist), 05 (Kirnberger), 06 (Vallot&Yng), 07 (1/4 Shift), 08 (1/4 Tone), 09 (1/8 Tone), 10 (Indian), 11 (Arabic 1), 12 (Arabic 2), 13 (Arabic 3)

M. TuningRoot (Micro Tuning Root)

Determines the root note for the Micro Tuning function.

Settings: C – B

Voice Mode

Voice Play

[F1] PLAY
[F3] PORTA
[F4] EG
[F5] ARP ED
[F6] EFFECT

Arpeggio Edit

[F2] TYPE
[F3] MAIN
[F4] LIMIT
[F5] PLAY FX

Normal Voice Edit

Common Edit

▶ [F1] GENERAL
[F2] OUTPUT
[F3] EQ
[F4] CTL SET
[F5] LFO
[F6] EFFECT

Element Edit

[F1] OSC
[F2] PITCH
[F3] FILTER
[F4] AMP
[F5] LFO
[F6] EQ

Drum Voice Edit

Common Edit

[F1] GENERAL
[F2] OUTPUT
[F3] EQ
[F4] CTL SET
[F6] EFFECT

Key Edit

[F1] OSC
[F2] PITCH
[F3] FILTER
[F4] AMP
[F6] EQ

Voice Job

[F1] INIT
[F2] RECALL
[F3] COPY
[F4] BULK

Supplementary Information

[SF3] PORTA (Portamento)

Switch (Portamento Switch)

Determines whether or not Portamento is applied to your keyboard performance using the current Voice.

Settings: off, on

Time (Portamento Time)

Determines the pitch transition time or rate when Portamento is applied.

Settings: 0 – 127

Mode (Portamento Mode)

Determines how Portamento is applied to your keyboard performance.

Settings: fingered, fulltime

TimeMode (Portamento Time Mode)

Determines how the pitch changes in time.

Settings: rate1, time1, rate2, time2

LegatoSlope (Portamento Legato Slope)

Determines the speed of the attack of legato notes, when Portamento Switch above is set to on and “Mono/Poly” is set to “mono.” (Legato notes “overlap” each other, the next being played before the previous is released.)

Settings: 0 – 7

[SF4] OTHER

A.Func1 (Assignable Function 1 Mode)

A.Func2 (Assignable Function 2 Mode)

Determines whether the ASSIGNABLE FUNCTION [1] and [2] buttons function as latch (hold) type or momentary type. For details on settings, see the “Synthesizer Parameter Manual” PDF document.

Settings: momentary, latch

PB Upper (Pitch Bend Range Upper)

PB Lower (Pitch Bend Range Lower)

Determines the maximum Pitch Bend Range in semitones.

Settings: -48 – +0 – +24

Assign1 (Assign 1 Value) Knob

Assign2 (Assign 2 Value) Knob

Determines the offset value by which the functions assigned to the Assign 1/2 will be shifted from their original settings.

Settings: -64 – +0 – +63

NOTE The functions assigned to the ASSIGN 1/2 Knobs can be set in the CTL SET display ([page 32](#)).

[F2] OUTPUT

Volume Knob

Determines the output level of the selected Voice.

Settings: 0 – 127

Pan Knob

Determines the stereo pan position of the selected Voice.

Settings: L63 (far left) – C (center) – R63 (far right)

ChoSend (Chorus Send) Knob

RevSend (Reverb Send) Knob

Determines the Send level of the signal sent from Insertion Effect A/B (or the bypassed signal) to the Chorus/Reverb effect.

Settings: 0 – 127

NOTE For details about effect connections, see [page 19](#).

Voice Mode

Voice Play

[F1] PLAY
[F3] PORTA
[F4] EG
[F5] ARP ED
[F6] EFFECT

Arpeggio Edit

[F2] TYPE
[F3] MAIN
[F4] LIMIT
[F5] PLAY FX

Normal Voice Edit

Common Edit

▶ [F1] GENERAL
▶ [F2] OUTPUT
[F3] EQ
[F4] CTL SET
[F5] LFO
[F6] EFFECT

Element Edit

[F1] OSC
[F2] PITCH
[F3] FILTER
[F4] AMP
[F5] LFO
[F6] EQ

Drum Voice Edit

Common Edit

[F1] GENERAL
[F2] OUTPUT
[F3] EQ
[F4] CTL SET
[F6] EFFECT

Key Edit

[F1] OSC
[F2] PITCH
[F3] FILTER
[F4] AMP
[F6] EQ

Voice Job

[F1] INIT
[F2] RECALL
[F3] COPY
[F4] BULK

Supplementary Information

[F3] EQ

This is a parametric EQ featuring three bands (High, Mid and Low). You can attenuate or boost the level of each frequency band (High, Mid, Low) to change the Voice sound.

FREQ (Frequency)

Determines the frequency for each frequency band.

Settings: Low: 50.1Hz – 2.00kHz
Mid: 139.7Hz – 10.1kHz
High: 503.8Hz – 14.0kHz

GAIN

Determines the level gain for the Frequency (set above), or the amount the selected frequency band is attenuated or boosted.

Settings: -12.00dB – +0.00dB – +12.00dB

Q

Determines the Q (bandwidth) for the Mid band.

Settings: 0.7 – 10.3

[F4] CTL SET (Controller Set)

[SF1] SET1/2 – [SF3] SET5/6

Since up to six Controller Sets can be assigned to each Voice, three pages (Sets 1/2, Sets 3/4 and Sets 5/6) are available. For details on Controller Set, see [page 53](#).

ElmSw (Element Switch)

Selects whether the controller will affect each individual Element or not.

Settings: Elements 1 to 8 enabled ("1" to "8") or disabled ("-").

NOTE This parameter is disabled when the Dest (Destination) described below is set to a parameter unrelated to the Voice Elements.

Source

Determines which controller is to be assigned to and used for the selected Controller Set. This controller then is used to control the parameter set in Destination below.

Settings: PB (Pitch Bend wheel), MW (Modulation wheel), AT (Aftertouch), FC1/FC2 (Foot controller 1/2), FS (Foot Switch), RB (Ribbon Controller), BC (Breath controller), AS1 (ASSIGN 1), AS2 (ASSIGN 2), FC2 (Foot Controller 2), AF1 (ASSIGNABLE FUNCTION [1]), AF2 (ASSIGNABLE FUNCTION [2])

NOTE When the foot switch is set to a Control Change number of 96 or higher in the CTL ASN display of the Utility mode, the foot switch will not be available as a "Source" of the Controller Set for the selected Voice.

Dest (Destination)

Determines the function that is controlled by the controller set in "Source."

Settings: See the "Control List" in the "Data List" PDF document.

Depth

Determines the degree to which the Source controller affects the Destination.

Settings: -64 – +0 – +63

Voice Mode

Voice Play

[F1] PLAY
[F3] PORTA
[F4] EG
[F5] ARP ED
[F6] EFFECT

Arpeggio Edit

[F2] TYPE
[F3] MAIN
[F4] LIMIT
[F5] PLAY FX

Normal Voice Edit

Common Edit

[F1] GENERAL
[F2] OUTPUT
▶ [F3] EQ
▶ [F4] CTL SET
[F5] LFO
[F6] EFFECT

Element Edit

[F1] OSC
[F2] PITCH
[F3] FILTER
[F4] AMP
[F5] LFO
[F6] EQ

Drum Voice Edit

Common Edit

[F1] GENERAL
[F2] OUTPUT
[F3] EQ
[F4] CTL SET
[F6] EFFECT

Key Edit

[F1] OSC
[F2] PITCH
[F3] FILTER
[F4] AMP
[F6] EQ

Voice Job

[F1] INIT
[F2] RECALL
[F3] COPY
[F4] BULK

Supplementary Information

[F5] LFO (Low Frequency Oscillator)

[SF1] WAVE

Wave

Selects the LFO waveform.

Settings: tri, tri+, sawup, sawdwn, squ1/4, squ1/3, squ, squ2/3, squ3/4, trpzd, S/H 1, S/H 2, user

Speed

Adjusts the speed (frequency) of LFO variation.

Settings: 0 – 63

TempoSync

Determines whether or not the LFO is synchronized to the tempo of the Arpeggio or sequencer (Song or Pattern).

Settings: off (not synchronized), on (synchronized)

TempoSpeed

This parameter is available only when “TempoSync” above has been set to “on.” It allows you to make detailed note value settings that determine how the LFO pulses in sync with the Arpeggio.

Settings: 16th, 8th/3 (eighth-note triplets), 16th. (dotted sixteenth notes), 8th, 4th/3 (quarter-note triplets), 8th. (dotted eighth notes), 4th (quarter notes), 2nd/3 (half-note triplets), 4th. (dotted quarter notes), 2nd (half notes), whole/3 (whole-note triplets), 2nd. (dotted half notes), 4th x 4 (quarter-note quadruplets; four quarter notes to the beat), 4th x 5 (quarter-note quintuplets; five quarter notes to the beat), 4th x 6 (quarter-note sextuplets; six quarter notes to the beat), 4th x 7 (quarter-note septuplets; seven quarter notes to the beat), 4th x 8 (quarter-note octuplets; eight quarter notes to the beat), 4th x 16 (sixteen quarter-notes to the beat), 4th x 32 (32 quarter notes to the beat), 4th x 64 (64 quarter notes to the beat)

NOTE The actual length of the note depends on the internal or external MIDI tempo setting.

PlayMode

Determines whether the LFO cycles repeatedly (loop) or only once (one shot).

Settings: loop, one shot

KeyOnReset

Determines whether or not the LFO is reset each time a note is pressed.

Settings: off, each-on, 1st-on

RandomSpeed

Determines the degree to which the LFO speed changes at random.

Settings: 0 – 127

[SF2] DELAY

Delay

Determines the delay time between the moment you press a key on the keyboard and the moment the LFO comes into effect.

Settings: 0 – 127

FadeIn (Fade In Time)

Determines the amount of time for the LFO effect to fade in (after the “Delay” time has elapsed).

Settings: 0 – 127

Hold

Determines the length of time during which the LFO is held at its maximum level.

Settings: 0 – 126, hold

FadeOut (Fade Out Time)

Determines the time over which the LFO effect is faded out (after the “Hold” time has elapsed).

Settings: 0 – 127

Voice Mode

Voice Play

[F1] PLAY
[F3] PORTA
[F4] EG
[F5] ARP ED
[F6] EFFECT

Arpeggio Edit

[F2] TYPE
[F3] MAIN
[F4] LIMIT
[F5] PLAY FX

Normal Voice Edit

Common Edit

[F1] GENERAL
[F2] OUTPUT
[F3] EQ
[F4] CTL SET
▶ [F5] LFO
[F6] EFFECT

Element Edit

[F1] OSC
[F2] PITCH
[F3] FILTER
[F4] AMP
[F5] LFO
[F6] EQ

Drum Voice Edit

Common Edit

[F1] GENERAL
[F2] OUTPUT
[F3] EQ
[F4] CTL SET
[F6] EFFECT

Key Edit

[F1] OSC
[F2] PITCH
[F3] FILTER
[F4] AMP
[F6] EQ

Voice Job

[F1] INIT
[F2] RECALL
[F3] COPY
[F4] BULK

Supplementary Information

[SF3] PHASE

Phase

Determines the starting phase point for the LFO Wave when it is reset.

Settings: 0, 90, 120, 180, 240, 270

OFFSET EL1 – EL8

Determines the offset values of the “Phase” parameter (above) for the respective Elements.

Settings: +0, +90, +120, +180, +240, +270

[SF4] BOX

From this display you can select the destination parameter for the LFO (in other words, which aspect of the sound the LFO controls), the Elements to be affected by the LFO, and the LFO Depth. The available three pages (boxes) for setting the destination let you assign multiple destinations.

ElmSw (LFO Element Switch)

Determines whether or not each Element is to be affected by the LFO.

Dest (Control Destination)

Determines the functions which will be controlled by the LFO Wave.

Settings: See the “Control List” in the “Data List” PDF document.

NOTE Regarding “Insertion Effect A Parameter 1 - 16,” “Insertion Effect B Parameter 1 - 16” and “Insertion Effect L Parameter 1 - 32” described in the Control List, the actual parameter names of the selected Effect type are shown on the display. If one of these names is shown, no function is assigned to that parameter.

Depth

Set the LFO Wave Depth (amplitude).

Settings: 0 – 127

DPTRATIO (Depth Ratio) EL1 – EL8

Determines the offset values of the “Depth” parameter (above) for the respective Elements.

Settings: 0 – 127

[SF5] USER

This menu is available only when the “Wave” parameter is set to “user.” You can create a custom LFO wave consisting of up to sixteen steps.

Template

This includes pre-programmed settings for creating an original LFO. You can set the wave randomly by pressing the [SF1] RANDOM button.

Settings: all-64..... Values of all steps are set to -64.
all0..... Values of all steps are set to 0.
all+64..... Values of all steps are set to +63.
sawup..... Creates a saw shaped upward wave.
sawdown..... Creates a saw shaped downward wave
evnstep..... Values of all even steps are set to -64, and values of all odd steps are set to +63.
oddstep..... Values of all odd steps are set to -64, and values of all even steps are set to +63.

Slope

Determines the slope or ramp characteristics of the LFO wave.

Settings: off (no slope), up, down, up&down

Value (Step Value)

Determines the level for each step set in the “Step” parameter.

Settings: -64 – +0 – +63

Step

Numerator: Selects the desired step.

Settings: 1 – 16

Denominator: Determines the maximum number of steps.

Settings: 2, 3, 4, 6, 8, 12, 16

Voice Mode

Voice Play

[F1] PLAY
[F3] PORTA
[F4] EG
[F5] ARP ED
[F6] EFFECT

Arpeggio Edit

[F2] TYPE
[F3] MAIN
[F4] LIMIT
[F5] PLAY FX

Normal Voice Edit

Common Edit

[F1] GENERAL
[F2] OUTPUT
[F3] EQ
[F4] CTL SET
▶ [F5] LFO
[F6] EFFECT

Element Edit

[F1] OSC
[F2] PITCH
[F3] FILTER
[F4] AMP
[F5] LFO
[F6] EQ

Drum Voice Edit

Common Edit

[F1] GENERAL
[F2] OUTPUT
[F3] EQ
[F4] CTL SET
[F6] EFFECT

Key Edit

[F1] OSC
[F2] PITCH
[F3] FILTER
[F4] AMP
[F6] EQ

Voice Job

[F1] INIT
[F2] RECALL
[F3] COPY
[F4] BULK

Supplementary Information

[F6] EFFECT

[SF1] CONNECT

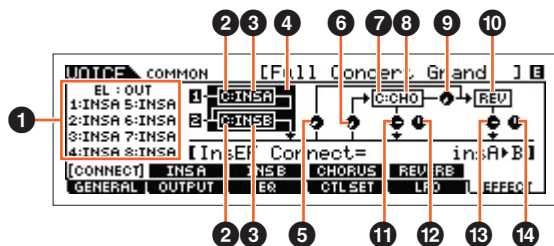

1 EL: OUT 1 – 8 (Element Out 1 – 8)

Determines which Insertion Effect (A or B) is used to process each individual Element. The “THRU” setting lets you bypass the Insertion Effects for the specified element. When the “InsEF Connect” (Insertion Effect Connection) is set to “vocoder,” the output is specified even if “EL: OUT” is set to either “INSA” or “INSB.”

Settings: THRU, INSA (Insertion Effect A), INSB (Insertion Effect B)

2 InsA Ctgr (Insertion Effect A Category)/InsB Ctgr (Insertion Effect B Category)

3 InsA Type (Insertion Effect A Type)/InsB Type (Insertion Effect B Type)

Determines the category and type for the Insertion Effect A/B. When the “InsEF Connect” is set to “vocoder,” this parameter indicates the “Vocoder Type” and determines the Effect type for the Vocoder.

Settings: For details on the editable Effect categories and types, see the “Data List” PDF document. Also, for details on the description for each Effect type, see the “Synthesizer Parameter Manual” PDF document.

4 InsEF Connect (Insertion Effect Connection)

Determines the effect routing for Insertion Effects A and B. The setting changes are shown on the diagram in the display, giving you a clear picture of how the signal is routed. For details, see the section “Effect connection in each mode” of the “Basic Structure” (page 19).

Settings: parallel, insA>B, insB>A, vocoder

NOTE When “vocoder” is selected, “VOCODER” is shown in the tab menu of the [SF2] and the tab menu of [SF3] disappears.

NOTE When “vocoder” is selected, the audio signal will be output from this instrument in mono.

NOTE For detailed instructions on using the Vocoder, see the Owner’s Manual.

5 Reverb Send

Adjusts the Reverb send level.

Settings: 0 – 127

6 Chorus Send

Adjusts the Chorus send level.

Settings: 0 – 127

7 Chorus Ctg (Chorus Effect Category)

8 Chorus Typ (Chorus Effect Type)

Determines the Chorus Effect category and type.

Settings: For details on the editable Effect categories and types, see the “Data List” PDF document. Also, for details on the description for each Effect type, see the “Synthesizer Parameter Manual” PDF document.

9 Chorus to Reverb

Determines the Send level of the signal sent from the Chorus Effect to the Reverb Effect.

Settings: 0 – 127

Voice Mode

Voice Play

- [F1] PLAY
- [F3] PORTA
- [F4] EG
- [F5] ARP ED
- [F6] EFFECT

Arpeggio Edit

- [F2] TYPE
- [F3] MAIN
- [F4] LIMIT
- [F5] PLAY FX

Normal Voice Edit

Common Edit

- [F1] GENERAL
- [F2] OUTPUT
- [F3] EQ
- [F4] CTL SET
- [F5] LFO
- [F6] EFFECT

Element Edit

- [F1] OSC
- [F2] PITCH
- [F3] FILTER
- [F4] AMP
- [F5] LFO
- [F6] EQ

Drum Voice Edit

Common Edit

- [F1] GENERAL
- [F2] OUTPUT
- [F3] EQ
- [F4] CTL SET
- [F6] EFFECT

Key Edit

- [F1] OSC
- [F2] PITCH
- [F3] FILTER
- [F4] AMP
- [F6] EQ

Voice Job

- [F1] INIT
- [F2] RECALL
- [F3] COPY
- [F4] BULK

Supplementary Information

10 Reverb Type

Selects the Reverb Effect type.

Settings: For details on the editable Effect categories and types, see the "Data List" PDF document. Also, for details on the description for each Effect type, see the "Synthesizer Parameter Manual" PDF document.

11 Chorus Return

Determines the return level of the Chorus effect.

Settings: 0 – 127

12 Chorus Pan

Determines the pan position of the Chorus effect sound.

Settings: L63 (far left) – C (center) – R63 (far right)

13 Reverb Return

Determines the return level of the Reverb effect.

Settings: 0 – 127

14 Reverb Pan

Determines the pan position of the Reverb effect sound.

Settings: L663 (far left) – C (center) – R63 (far right)

[SF2] INS A (Insertion Effect A)

[SF3] INS B (Insertion Effect B)

[SF4] CHORUS

[SF5] REVERB

From these displays, you can set the Effect related parameters when the "InsEF Connect" (Insertion Effect Connection) in the CONNECT display is set to "parallel," "insA>B," or "insB>A." These displays consist of multiple pages and can be selected by pressing the Cursor [<]/[>] buttons. From these displays, you can also set each parameter of the selected Effect type individually and manually.

1 Category

2 Type

Determines the category and type for the selected effect.

Settings: For details on the editable Effect categories and types, see the "Data List" PDF document. Also, for details on the description for each Effect type, see the "Synthesizer Parameter Manual" PDF document.

NOTE "Category" indication is not shown in the REVERB display.

3 Preset

Allows you to call up pre-programmed settings for each Effect type, designed to be used for specific applications and situations. You can change how the sound is affected by the selected pre-programmed settings.

NOTE For a list of all Preset Performances, see the "Data List" PDF document.

4 Effect Parameters

The Effect parameter differs depending on the currently selected effect type. For information on the editable Effect parameters in each Effect type, see the "Data List" PDF document. Also, for details on the description for the each Effect parameter, see the "Synthesizer Parameter Manual" PDF document.

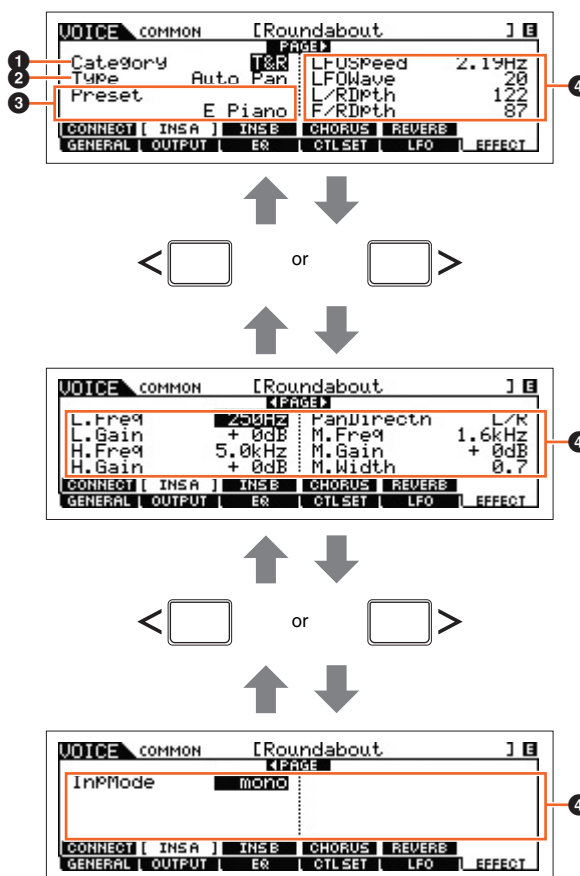

Voice Mode

Voice Play

- [F1] PLAY
- [F3] PORTA
- [F4] EG
- [F5] ARP ED
- [F6] EFFECT

Arpeggio Edit

- [F2] TYPE
- [F3] MAIN
- [F4] LIMIT
- [F5] PLAY FX

Normal Voice Edit

Common Edit

- [F1] GENERAL
- [F2] OUTPUT
- [F3] EQ
- [F4] CTL SET
- [F5] LFO
- [F6] EFFECT

Element Edit

- [F1] OSC
- [F2] PITCH
- [F3] FILTER
- [F4] AMP
- [F5] LFO
- [F6] EQ

Drum Voice Edit

Common Edit

- [F1] GENERAL
- [F2] OUTPUT
- [F3] EQ
- [F4] CTL SET
- [F6] EFFECT

Key Edit

- [F1] OSC
- [F2] PITCH
- [F3] FILTER
- [F4] AMP
- [F6] EQ

Voice Job

- [F1] INIT
- [F2] RECALL
- [F3] COPY
- [F4] BULK

Supplementary Information

[SF2] VOCODER

This display is called up via the [SF2] is available only when the “InsEF Connect” is set to “vocoder” in the [SF1] CONNECT display. The Vocoder-related parameters in this display determine the way in which the Vocoder is applied.

NOTE For more details about the Vocoder function, see [page 21](#).

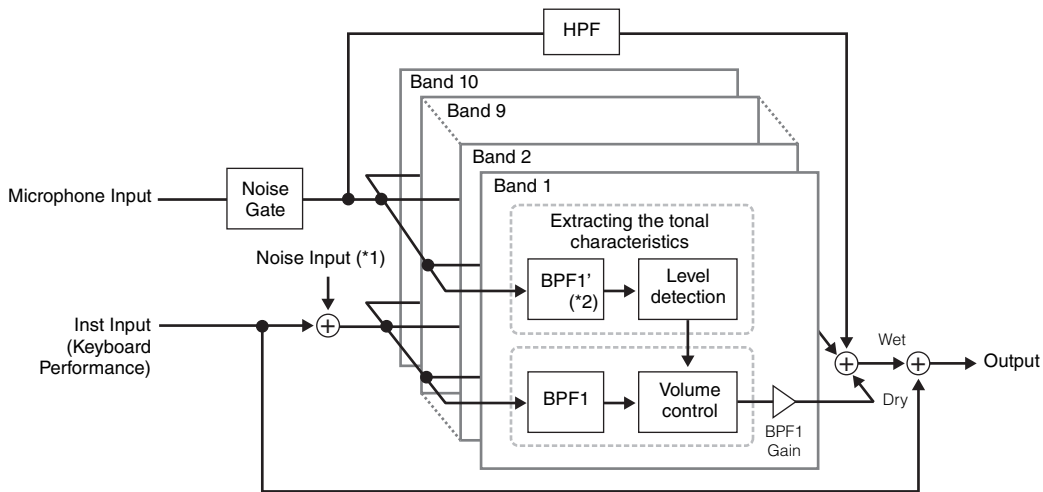

*1 The noise generated in the Vocoder unit is used.

*2 The cutoff frequency of the BPF1' may not be same as the one of the BPF1. This depends on the settings of Formant Shift and Formant Offset.

Type

Determines whether or not the Vocoder is applied to the current Voice. When set to “Thru,” the Vocoder is not applied to the Voice.

Settings: Thru, Vocoder

Attack (Vocoder Attack Time)

Determines the attack time of the Vocoder sound.

Settings: 1ms – 200ms

Release (Vocoder Release Time)

Determines the release time of the Vocoder sound.

Settings: 10ms – 3000ms

MicGateTh (Mic Gate Threshold)

Determines the threshold level of the noise gate for the microphone sound.

Settings: -72dB – -30dB

GateSw (Gate Switch)

Determines whether or not the microphone sound will be output at the level set in the “HPFOutLvl” parameter when you release the notes. Normally, you should set this to “on.”

Settings: off, on
 off: The microphone sound always will be output.
 on: The microphone sound will be output only while a note is pressed the note.

HPF (High Pass Filter)

Determines the HPF cutoff frequency for the microphone input sound. Setting this to higher values emphasizes the higher frequency consonant and sibilant sounds (which make words easier to understand).

Settings: thru, 500Hz – 16.0kHz

HPFOutLvl (High Pass Filter Output Level)

Determines the level of the microphone sound that is output from the HPF (High Pass Filter).

Settings: 0 – 127

FormantShift

Determines the amount (in BPF) by which the cutoff frequency value of the BPFs (for the Inst Input) is shifted. This parameter can be used to adjust the pitch of the Vocoder sound.

Settings: -2, -1, +0, +1, +2

Voice Mode

Voice Play

- [F1] PLAY
- [F3] PORTA
- [F4] EG
- [F5] ARP ED
- [F6] EFFECT

Arpeggio Edit

- [F2] TYPE
- [F3] MAIN
- [F4] LIMIT
- [F5] PLAY FX

Normal Voice Edit

Common Edit

- [F1] GENERAL
- [F2] OUTPUT
- [F3] EQ
- [F4] CTL SET
- [F5] LFO
- [F6] EFFECT

Element Edit

- [F1] OSC
- [F2] PITCH
- [F3] FILTER
- [F4] AMP
- [F5] LFO
- [F6] EQ

Drum Voice Edit

Common Edit

- [F1] GENERAL
- [F2] OUTPUT
- [F3] EQ
- [F4] CTL SET
- [F6] EFFECT

Key Edit

- [F1] OSC
- [F2] PITCH
- [F3] FILTER
- [F4] AMP
- [F6] EQ

Voice Job

- [F1] INIT
- [F2] RECALL
- [F3] COPY
- [F4] BULK

Supplementary Information

FormantOffset

Finely adjusts the cutoff frequencies of all BPFs (for the Inst Input). This parameter can be used to fine-tune the pitch of the Vocoder sound.

Settings: -63 – +0 – +63

MicLvl (Mic Level)

Determines the level of the microphone sound which is to be input to the Vocoder.

Settings: 0 – 127

InstInpLvl (Inst Input Level)

Determines the level of the keyboard performance sound which is to be input to the Vocoder.

Settings: 0 – 127

NoisInpLvl (Noise Input Level)

Determines the level of the noise sound which is input to the Vocoder. This can be used to emphasize sibilant and plosive sounds, and make speech-like characteristics more pronounced.

Settings: 0 – 127

OutLvl (Output Level)

Determines the output level of the Vocoder.

Settings: 0 – 127

Dry/Wet (Dry/Wet Balance)

Determines the balance between the dry sound (no effect applied) and the wet sound (effect applied).

Settings: D63>W – D=W – D<W63

BPF1 – 10Gain (Band Pass Filter 1 – 10 Gain)

Determines the output gain of each Band Pass Filter (1 – 10) for the Inst Input (keyboard performance sound). BPF1 corresponds to the lowest Formant while BPF 10 corresponds to the highest Formant.

Settings: -18dB – +18dB

Element Edit

Operation

[VOICE] → Normal Voice selection → [EDIT] → Element selection

[F1] OSC (Oscillator)**[SF1] WAVE (Waveform)**

From this display you can select the desired waveform or sound used for the Element.

ElementSw (Element Switch)

Determines whether the currently selected Element is on or off.

Settings: off (inactive), on (active)

ElementGroup

Determines the group of the XA feature (page 5) so that the Elements of the same group are called up in order or randomly. The setting here is not available when the XA Control parameters of all Elements are set to "normal."

Settings: 1 – 8

XACtrl (XA Control)

Determines the functioning of the Expanded Articulation (XA) feature of an Element.

Settings: normal, legato, keyOffSound, waveCycle, waveRandom, all AF off (all Assignable Function off), AF1 On (Assignable Function 1 on), AF2 On (Assignable Function 2 on)

Voice Mode**Voice Play**

[F1] PLAY
[F3] PORTA
[F4] EG
[F5] ARP ED
[F6] EFFECT

Arpeggio Edit

[F2] TYPE
[F3] MAIN
[F4] LIMIT
[F5] PLAY FX

Normal Voice Edit**Common Edit**

[F1] GENERAL
[F2] OUTPUT
[F3] EQ
[F4] CTL SET
[F5] LFO
▶ [F6] EFFECT

Element Edit

▶ [F1] OSC
[F2] PITCH
[F3] FILTER
[F4] AMP
[F5] LFO
[F6] EQ

Drum Voice Edit**Common Edit**

[F1] GENERAL
[F2] OUTPUT
[F3] EQ
[F4] CTL SET
[F6] EFFECT

Key Edit

[F1] OSC
[F2] PITCH
[F3] FILTER
[F4] AMP
[F6] EQ

Voice Job

[F1] INIT
[F2] RECALL
[F3] COPY
[F4] BULK

Supplementary Information

Wave Bank

Determines the Waveform Bank assigned to the Element. The available Banks are Preset (“pre”) and User (“user”). The Preset Bank includes the preset Waveforms while the User Bank includes the User Waveforms (stored to the optional Flash Memory Expansion Module).

Settings: pre, user

WaveCategory (Waveform Category)

WaveNumber (Waveform Number)

Determines the Waveform for the selected Element. See the “Waveform List” in the “Data List” PDF document.

[SF2] OUTPUT

From this display you can set certain output parameters for the selected Element.

KeyOnDelay

Determines the time (or elapsed delay) between the moment you press a note on the keyboard and the point at which the sound is actually played. You can set different delay times for each Element.

Settings: 0 – 127

DelayTempoSync

Determines whether or not “KeyOnDelay” is synchronized to the tempo of the Arpeggio or sequencer (Song or Pattern).

Settings: off (not synchronized), on (synchronized)

DelayTempo

Determines the timing of “KeyOnDelay” when “DelayTempoSync” is set to on.

Settings: 16th, 8th/3 (eighth-note triplets), 16th. (dotted sixteenth notes), 8th, 4th/3 (quarter-note triplets), 8th. (dotted eighth notes), 4th (quarter notes), 2nd/3 (half-note triplets), 4th. (dotted quarter notes), 2nd (half notes), whole/3 (whole-note triplets), 2nd. (dotted half notes), 4thx4 (quarter-note quadruplets; four quarter notes to the beat), 4thx5 (quarter-note quintuplets; five quarter notes to the beat), 4thx6 (quarter-note sextuplets; six quarter notes to the beat), 4thx7 (quarter-note septuplets; seven quarter notes to the beat), 4thx8 (quarter-note octuplets; eight quarter notes to the beat)

InsEffectOut (Insertion Effect Out)

Determines which Insertion Effect (A or B) is used to process each individual Element. This parameter is the same as “EL: OUT” (page 35) on the [F6] EFFECT → [SF1] CONNECT display in Normal Voice Common Edit. Making a setting here automatically changes the setting of that parameter as well.

Settings: thru (through), ins A (insertion A), ins B (insertion B)

[SF3] LIMIT

NoteLimit

Determines the lowest and highest notes of the keyboard range for each Element.

Settings: C -2 – G8

NOTE You can also set the note directly from the keyboard, by holding down the [SF6] KBD button and pressing the desired key.

VelocityLimit

Determines the minimum and maximum values of the velocity range within which each Element will respond.

Settings: 1 – 127

VelCrossFade (Velocity Cross Fade)

Determines how gradually the sound of an Element decreases in volume in proportion to the distance of velocity changes outside the Velocity Limit setting (above).

Settings: 0 – 127

Voice Mode

Voice Play

- [F1] PLAY
- [F3] PORTA
- [F4] EG
- [F5] ARP ED
- [F6] EFFECT

Arpeggio Edit

- [F2] TYPE
- [F3] MAIN
- [F4] LIMIT
- [F5] PLAY FX

Normal Voice Edit

Common Edit

- [F1] GENERAL
- [F2] OUTPUT
- [F3] EQ
- [F4] CTL SET
- [F5] LFO
- [F6] EFFECT

Element Edit

- ▶ [F1] OSC
- [F2] PITCH
- [F3] FILTER
- [F4] AMP
- [F5] LFO
- [F6] EQ

Drum Voice Edit

Common Edit

- [F1] GENERAL
- [F2] OUTPUT
- [F3] EQ
- [F4] CTL SET
- [F6] EFFECT

Key Edit

- [F1] OSC
- [F2] PITCH
- [F3] FILTER
- [F4] AMP
- [F6] EQ

Voice Job

- [F1] INIT
- [F2] RECALL
- [F3] COPY
- [F4] BULK

Supplementary Information

[F2] PITCH

[SF1] TUNE

From this display you can set various pitch-related parameters for the selected Element.

Coarse (Coarse Tuning)

Determines the pitch of each Element in semitones.

Settings: -48 – +0 – +48

Fine (Fine Tuning)

Determines the fine tuning for the pitch of each Element.

Settings: -64 – +0 – +63

FineScaling (Fine Scaling Sensitivity)

Determines the degree to which the notes (specifically, their position or octave range) affect the pitch in Fine Tuning (above) of the selected Element, regarding C3 as the basic pitch.

Settings: -64 – +0 – +63

Random

Allows you to randomly vary the pitch of the Element for each note played.

Settings: 0 – 127

[SF2] VEL SENS (Velocity Sensitivity)

From this display you can determine how the PEG (Pitch EG) responds to velocity.

EGTime (EG Time Velocity Sensitivity)

Segment (EG Time Velocity Sensitivity Segment)

Determines the velocity sensitivity of the PEG Time parameters. Select the Segment, and then set its Time parameter.

Settings: EGTime: -64 – +0 – +63

Settings: Segment: atk, atk+dcy, dcy, atk+rls, all

- atk (attack)..... EG Time parameter affects Attack time.
- atk+dcy (attack + decay)..... EG Time Value affects Attack/Decay1 time.
- dcy (decay)..... EG Time parameter affects Decay Time
- atk+rls (attack + release)..... EG Time Value affects Attack/Release time.
- all..... EG Time affects all PEG Time parameters.

EGDepth (EG Depth Velocity Sensitivity)

Curve (EG Depth Velocity Sensitivity Curve)

Determines the velocity sensitivity of the PEG Depth. The Curve parameter lets you select from five different preset velocity curves (graphically indicated in the display) that determine how velocity affects the Pitch EG Depth.

Settings: EGDepth: -64 – +0 – +63

Settings: Curve: 0 – 4

Pitch (Pitch Velocity Sensitivity)

Determines the velocity sensitivity of the pitch.

Settings: -64 – +0 – +63

[SF3] PEG (Pitch Envelope Generator)

From this display you can make all time and level settings for the Pitch EG, which determine how the pitch of the sound changes over time. These can be used to control the change in pitch from the moment a note is pressed on the keyboard to the moment the sound stops. The full names of the available parameters are shown in the chart below, as they appear in the display.

	HOLD	ATK (Attack)	DCY1 (Decay 1)	DCY2 (Decay 2)	REL (Release)	DEPTH
TIME	Hold Time	Attack Time	Decay 1 Time	Decay 2 Time	Release Time	
LEVEL	Hold Level	Attack Level	Decay 1 Level	Decay 2 Level	Release Level	Depth

Settings: TIME: 0 – 127

LEVEL: -128 – +0 – +127

DEPTH: -64 – +0 – +63

NOTE For details on PEG, see the "Synthesizer Parameter Manual" PDF document.

Voice Mode

Voice Play

- [F1] PLAY
- [F3] PORTA
- [F4] EG
- [F5] ARP ED
- [F6] EFFECT

Arpeggio Edit

- [F2] TYPE
- [F3] MAIN
- [F4] LIMIT
- [F5] PLAY FX

Normal Voice Edit

Common Edit

- [F1] GENERAL
- [F2] OUTPUT
- [F3] EQ
- [F4] CTL SET
- [F5] LFO
- [F6] EFFECT

Element Edit

- [F1] OSC
- [F2] PITCH
- [F3] FILTER
- [F4] AMP
- [F5] LFO
- [F6] EQ

Drum Voice Edit

Common Edit

- [F1] GENERAL
- [F2] OUTPUT
- [F3] EQ
- [F4] CTL SET
- [F6] EFFECT

Key Edit

- [F1] OSC
- [F2] PITCH
- [F3] FILTER
- [F4] AMP
- [F6] EQ

Voice Job

- [F1] INIT
- [F2] RECALL
- [F3] COPY
- [F4] BULK

Supplementary Information

[SF4] KEY FLW (Key Follow)

From this display you can set the Key Follow effect—in other words, how the pitch of the Element and its Pitch EG respond to the particular notes (or octave range) you play.

PitchSens (Pitch Key Follow Sensitivity)

Determines the sensitivity of the Key Follow effect (the pitch interval of adjacent notes). The Center Key (next parameter) is used as the basic pitch for this parameter.

Settings: -200% – +0% – +200%

CenterKey (Pitch Key Follow Sensitivity Center Key)

Determines the central note or pitch for the Key Follow effect on pitch.

Settings: C -2 – G8

NOTE You can also set the note directly from the keyboard, by holding down the [SF6] KBD button and pressing the desired key.

EGTimeSens (EG Time Key Follow Sensitivity)

Determines the degree to which the notes (specifically, their position or octave range) affect the Pitch EG times of the selected Element. The Center Key (next parameter) is used as the basic pitch for this parameter.

Settings: -64 – +0 – +63

CenterKey (EG Time Key Follow Sensitivity Center Key)

Determines the central note or pitch for the Key Follow effect on Pitch EG.

Settings: C -2 – G8

NOTE You can also set the note directly from the keyboard, by holding down the [SF6] KBD button and pressing the desired key.

[F3] FILTER

[SF1] TYPE

These allow you to make comprehensive settings for the Filter unit. The available parameters differ depending on which Filter type is selected here.

Type

Determines the Filter Type for the current Element. Basically, there are four different filters: LPF (Low Pass Filter), HPF (High Pass Filter), BPF (Band Pass Filter) and BEF (Band Elimination Filter). For details on settings, see the “Synthesizer Parameter Manual” PDF document.

Settings: LPF24D, LPF24A, LPF18, LPF18s, LPF12+HPF12, LPF6+HPF12, HPF24D, HPF12, BPF12D, BPFw, BPF6, BEF12, BEF6, DualLPF, DualHPF, DualBPF, DualBEF, LPF12+BPF6, thru

Gain

Sets the Gain (the amount of boost applied to the signal sent to the Filter Unit).

Settings: 0 – 255

Cutoff (Cutoff Frequency)

Determines the cutoff frequency for the Filter. This is used as the basic frequency for the selected Filter Type.

Settings: 0 – 255

Resonance/Width

This parameter's function varies according to the selected Filter Type. If the selected filter is an LPF, HPF, BPF (excluding BPFw), or BEF, this parameter is used to set the Resonance. For the BPFw, it is used to adjust the frequency bandwidth. This parameter is used to set the amount of Resonance (harmonic emphasis) applied to the signal at the cutoff frequency. This can be used in combination with the “Cutoff” parameter to add further character to the sound. For the BPFw, this parameter is used to adjust the width of the band of signal frequencies passed by the filter.

Settings: 0 – 127

Distance

Determines the distance between the Cutoff Frequencies for the Dual Filter types (two filters connected in parallel fashion) and the LPF12+BPF6 filter.

Settings: -128 – +0 – +127

Voice Mode

Voice Play

[F1] PLAY
[F3] PORTA
[F4] EG
[F5] ARP ED
[F6] EFFECT

Arpeggio Edit

[F2] TYPE
[F3] MAIN
[F4] LIMIT
[F5] PLAY FX

Normal Voice Edit

Common Edit

[F1] GENERAL
[F2] OUTPUT
[F3] EQ
[F4] CTL SET
[F5] LFO
[F6] EFFECT

Element Edit

[F1] OSC
▶ [F2] PITCH
▶ [F3] FILTER
[F4] AMP
[F5] LFO
[F6] EQ

Drum Voice Edit

Common Edit

[F1] GENERAL
[F2] OUTPUT
[F3] EQ
[F4] CTL SET
[F6] EFFECT

Key Edit

[F1] OSC
[F2] PITCH
[F3] FILTER
[F4] AMP
[F6] EQ

Voice Job

[F1] INIT
[F2] RECALL
[F3] COPY
[F4] BULK

Supplementary Information

HPFCutoff (High Pass Filter Cutoff Frequency)

Determines the central frequency for the Key Follow parameter (below) of the HPF. When one of the filter types "LPF12+HPF12" or "LPF6+HPF12" is selected, this parameter is available.

Settings: 0 – 255

HPFKeyFlw (High Pass Filter Cutoff Key Follow)

Sets the Key Follow function for the frequency of the "HPF Cutoff" parameter. This parameter is available only when one of the filter types "LPF12+HPF12" or "LPF6+HPF12" is selected.

Settings: -200% – +0% – +200%

CenterKey (High Pass Filter Cutoff Key Follow Sensitivity Center Key)

This indicates that the central note for "HPFKeyFlw" above is C3. Keep in mind that this is for display purposes only; the value cannot be changed.

[SF2] VEL SENS (Velocity Sensitivity)

From this display you can determine how the Filter and the FEG respond to velocity.

EGTime (EG Time Velocity Sensitivity)

Segment (EG Time Velocity Sensitivity Segment)

Determines the velocity sensitivity of the FEG's Time parameters. Select the Segment, and then set its Time parameter.

Settings: Time: -64 – +0 – +63

Settings: Segment: atk, atk+dcy, dcy, atk+rls, all

- atk (attack)..... EG Time parameter affects Attack time.
- atk+dcy (attack + decay)..... EG Time Value affects Attack/Decay1 time.
- dcy (decay) EG Time parameter affects Decay Time
- atk+rls (attack + release) EG Time Value affects Attack/Release time.
- all EG Time affects all FEG Time parameters.

EGDepth (EG Depth Velocity Sensitivity)

Curve (EG Depth Velocity Sensitivity Curve)

Determines the velocity sensitivity of the FEG Depth parameter.

Settings: EGDepth: -64 – +0 – +63

Settings: Curve: 0 – 4

Cutoff (Cutoff Velocity Sensitivity)

Determines the degree to which velocity affects the Cutoff frequency of the Filter EG.

Settings: -64 – +0 – +63

Resonance (Resonance Velocity Sensitivity)

Determines the degree to which velocity affects the Resonance of the Filter EG.

Settings: -64 – +0 – +63

[SF3] FEG (Filter Envelope Generator)

This allows you to make all the time and level settings for the Filter EG, which determine how the tonal quality of the sound changes over time. These parameters can be used to control the change in Cutoff Frequency from the moment a note is pressed on the keyboard to the moment the sound stops. The full names of the available parameters are shown in the chart below, as they appear in the display.

	HOLD	ATK (Attack)	DCY1 (Decay 1)	DCY2 (Decay 2)	REL (Release)	DEPTH
TIME	Hold Time	Attack Time	Decay 1 Time	Decay 2 Time	Release Time	
LEVEL	Hold Level	Attack Level	Decay 1 Level	Decay 2 Level	Release Level	Depth

Settings: TIME: 0 – 127

LEVEL: -128 – +0 – +127

DEPTH: -64 – +0 – +63

NOTE For details on FEG, see the "Synthesizer Parameter Manual" PDF document.

Voice Mode

Voice Play

- [F1] PLAY
- [F3] PORTA
- [F4] EG
- [F5] ARP ED
- [F6] EFFECT

Arpeggio Edit

- [F2] TYPE
- [F3] MAIN
- [F4] LIMIT
- [F5] PLAY FX

Normal Voice Edit

Common Edit

- [F1] GENERAL
- [F2] OUTPUT
- [F3] EQ
- [F4] CTL SET
- [F5] LFO
- [F6] EFFECT

Element Edit

- [F1] OSC
- [F2] PITCH
- [F3] FILTER
- [F4] AMP
- [F5] LFO
- [F6] EQ

Drum Voice Edit

Common Edit

- [F1] GENERAL
- [F2] OUTPUT
- [F3] EQ
- [F4] CTL SET
- [F6] EFFECT

Key Edit

- [F1] OSC
- [F2] PITCH
- [F3] FILTER
- [F4] AMP
- [F6] EQ

Voice Job

- [F1] INIT
- [F2] RECALL
- [F3] COPY
- [F4] BULK

Supplementary Information

[SF4] KEY FLW (Key Follow)

From this display you can set the Key Follow effect for the Filter—in other words, how the tonal qualities of the Element and its Filter EG respond to the particular notes (or octave range) you play.

CutoffSens (Cutoff Key Follow Sensitivity)

Determines the degree to which the notes (specifically, their position or octave range) affect the Cutoff Frequency (above) of the selected Element, assuming C3 as the basic pitch.

Settings: -200% – +0% – +200%

CenterKey (Cutoff Key Follow Sensitivity Center Key)

This indicates that the central note for “CutoffSens” above is C3. Keep in mind that this is for display purposes only; the value cannot be changed.

EGTimeSens (EG Time Key Follow Sensitivity)

Determines the degree to which the notes (specifically, their position or octave range) affect the Filter EG times of the selected Element. The basic speed of change for the FEG is at the note specified in CenterKey (below).

Settings: -64 – +0 – +63

CenterKey (EG Time Key Follow Sensitivity Center Key)

Determines the central note for the “EGTimeSens” parameter above.

Settings: C -2 – G8

NOTE You can also set the note directly from the keyboard, by holding down the [SF6] KBD button and pressing the desired key.

[SF5] SCALE (Filter Scaling)

Break Point 1 – 4

Determines the four Break Points by specifying the respective note numbers.

Settings: C -2 – G8

NOTE You can also set the Break Point directly from the keyboard, by holding down the [SF6] KBD button and pressing the desired key.

NOTE Break Point 1 to Break Point 4 will be automatically be arranged in ascending order across the keyboard.

Offset 1 – 4

Determines the offset value to the Cutoff Frequency at each Break Point.

Settings: -128 – +0 – +127

NOTE Regardless of the size of these Offsets, the minimum and maximum Cutoff limits (values of 0 and 127, respectively) cannot be exceeded.

NOTE Any note played below the Break Point 1 note results in the Break Point 1 Level setting. Likewise, any note played above the Break Point 4 note results in the Break Point 4 Level setting.

NOTE For information on setting examples for Filter Scaling, see the “Synthesizer Parameter Manual” PDF document.

[F4] AMP (Amplitude)

[SF1] LVL/PAN (Level/Pan)

This display not only lets you make basic Level and Pan settings for each individual Element, it also gives you some detailed and unusual parameters for affecting Pan position.

Level

Use these to set the level of each Element.

Settings: 0 – 127

Pan

Determines the stereo Pan position for the selected Element.

Settings: L63 (far left) – C (center) – R63 (far right)

AlternatePan

Determines the amount by which the sound of the selected Drum key is panned alternately left and right for each note you press. The Pan setting (above) is used as the basic Pan position.

Settings: L64 – C – R63

Voice Mode

Voice Play

[F1] PLAY
[F3] PORTA
[F4] EG
[F5] ARP ED
[F6] EFFECT

Arpeggio Edit

[F2] TYPE
[F3] MAIN
[F4] LIMIT
[F5] PLAY FX

Normal Voice Edit

Common Edit

[F1] GENERAL
[F2] OUTPUT
[F3] EQ
[F4] CTL SET
[F5] LFO
[F6] EFFECT

Element Edit

[F1] OSC
[F2] PITCH
▶ [F3] FILTER
▶ [F4] AMP
[F5] LFO
[F6] EQ

Drum Voice Edit

Common Edit

[F1] GENERAL
[F2] OUTPUT
[F3] EQ
[F4] CTL SET
[F6] EFFECT

Key Edit

[F1] OSC
[F2] PITCH
[F3] FILTER
[F4] AMP
[F6] EQ

Voice Job

[F1] INIT
[F2] RECALL
[F3] COPY
[F4] BULK

Supplementary Information

RandomPan

Determines the amount by which the sound of the selected Element is panned randomly left and right for each note you press. The Pan setting (above) is used as the Center Pan position.

Settings: 0 – 127

ScalingPan

Determines the degree to which the notes (specifically, their position or octave range) affect the Pan position, left and right, of the selected Element. At note C3, the main Pan setting (above) is used for the basic Pan position.

Settings: -64 – +0 – +63

[SF2] VEL SENS (Velocity Sensitivity)

From this display you can determine how the Amplitude (volume) EG responds to velocity.

EGTime (EG Time Velocity Sensitivity)

Segment (EG Time Velocity Sensitivity Segment)

Determines the velocity sensitivity of the AEG's Time parameters. Select the "Segment," and then set its "EGTime" parameter.

Settings: Time: -64 – +0 – +63

Settings: Segment: atk, atk+dcy, dcy, atk+r/s, all

- atk (attack)..... EG Time parameter affects Attack time.
- atk+dcy (attack + decay)..... EG Time Value affects Attack/Decay1 time.
- dcy (decay) EG Time parameter affects Decay Time.
- atk+r/s (attack + release) EG Time Value affects Attack/Release time.
- all EG Time affects all AEG Time parameters.

Level (Level Velocity Sensitivity)

Offset (Level Velocity Sensitivity Offset)

Curve (Level Velocity Sensitivity Curve)

Determines the velocity sensitivity of the Amplitude EG Level. The "Offset" parameter raises or lowers the level specified at the "Level." The "Curve" parameter determines how velocity affects the Amplitude EG.

Settings: Level: -64 – +0 – +63

Settings: Offset: 0 – 127

Settings: Curve: 0 – 4

[SF3] AEG (Amplitude EG)

This allows you to make all the time and level settings for the Amplitude EG, which determine how the volume of the sound changes over time. Using the AEG, you can control the transition in volume from the moment the sound starts is to the moment the sound stops. The full names of the available parameters are shown in the chart below, as they appear in the display.

	INT (Initial)	ATK (Attack)	DCY1 (Decay 1)	DCY2 (Decay 2)	REL (Release)	SUS (Sustain)
TIME	---	Attack Time	Decay 1 Time	Decay 2 Time	Release Time	Half Damper Time
LEVEL	Initial Level	Attack Level	Decay 1 Level	Decay 2 Level	---	Half Damper Switch

Initial Level, Attack Time/Level, Decay 1 Time/Level, Decay 2 Time/Level, Release Time

Settings: TIME: 0 – 127

LEVEL: -128 – +0 – +127

Half Damper Time

Determines how quickly the sound decays to silence after the key is released while holding down the Foot Controller FC3 with the Half Damper Switch parameter turned on.

Settings: 0 – 127

Half Damper Switch

When the Half Damper Switch is set to on, you can produce a "half-pedal" effect just as on a real acoustic piano by using the optional FC3 Foot Controller connected to the FOOT SWITCH [SUSTAIN] jack on the rear panel.

Settings: off, on

NOTE When you wish to recreate a half-damper effect using the optional FC3, set the "Sustain Pedal" (Foot Switch Sustain Pedal Select) parameter to "FC3 (Half On)" in the CTL ASN display (page 145) of the Utility mode. Note that this setting is not necessary when controlling the half-damper by sending Control Change messages from an external MIDI device to the instrument.

NOTE For details on AEG, see the "Synthesizer Parameter Manual" PDF document.

Voice Mode

Voice Play	
[F1] PLAY	
[F3] PORTA	
[F4] EG	
[F5] ARP ED	
[F6] EFFECT	
Arpeggio Edit	
[F2] TYPE	
[F3] MAIN	
[F4] LIMIT	
[F5] PLAY FX	
Normal Voice Edit	
Common Edit	
[F1] GENERAL	
[F2] OUTPUT	
[F3] EQ	
[F4] CTL SET	
[F5] LFO	
[F6] EFFECT	
Element Edit	
[F1] OSC	
[F2] PITCH	
[F3] FILTER	
[F4] AMP	
[F5] LFO	
[F6] EQ	
Drum Voice Edit	
Common Edit	
[F1] GENERAL	
[F2] OUTPUT	
[F3] EQ	
[F4] CTL SET	
[F6] EFFECT	
Key Edit	
[F1] OSC	
[F2] PITCH	
[F3] FILTER	
[F4] AMP	
[F6] EQ	
Voice Job	
[F1] INIT	
[F2] RECALL	
[F3] COPY	
[F4] BULK	
Supplementary Information	

[SF4] KEY FLW (Key Follow)

From this display you can set the Key Follow effect for Amplitude; in other words, how the volume of the Element and its Amplitude EG respond to the particular notes (or octave range) you play.

LevelSens (Level Key Follow Sensitivity)

Determines the degree to which the notes (specifically, their position or octave range) affect the volume of the selected Element. A Center Key setting of C3 is used as the basic setting.

Settings: -200% – +0% – +200%

CenterKey (Level Key Follow Sensitivity Center Key)

This indicates that the central note for "LevelSens" above is C3. Keep in mind that this is for display purposes only; the value cannot be changed.

EGTimeSens (EG Time Key Follow Sensitivity)

Determines the degree to which the notes (specifically, their position or octave range) affect the Amplitude EG times of the selected Element. The Center Key (next parameter) is used as the basic amplitude for this parameter.

Settings: -64 – +0 – +63

CenterKey (EG Time Key Follow Sensitivity Center Key)

Determines the central note for the "EGTimeSens" parameter above.

Settings: C -2 – G8

NOTE You can also set the note directly from the keyboard, by holding down the [SF6] KBD button and pressing the desired key.

RelAdjust (EG Time Key Follow Sensitivity Release Adjustment)

Determines the sensitivity of "EGTimeSens" to EG Release.

Settings: -64 – +0 – +63

[SF5] SCALE (Amplitude Scaling)

Break Point 1 – 4

Determines the four Break Points by specifying the note numbers respectively.

Settings: C -2 – G8

NOTE You can also set the Break Point directly from the keyboard, by holding down the [SF6] KBD button and pressing the desired key.

NOTE Break Point 1 to Break Point 4 will be automatically be arranged in ascending order across the keyboard.

Offset 1 – 4

Determines the offset value to the "Level" setting for each Break Point.

Settings: -128 – +0 – +127

NOTE For details on setting example of the Amplitude Scaling, see the "Synthesizer Parameter Manual" PDF document.

[F5] LFO (Low Frequency Oscillator)

Wave

Selects the LFO waveform that is used to vary the sound.

Settings: saw, tri, squ

saw (sawtooth wave)

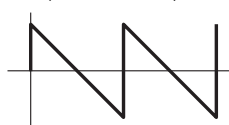

tri (triangle wave)



squ (square wave)

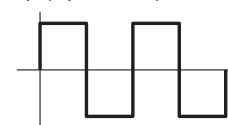

Speed

Adjusts the speed (frequency) of LFO variation. The larger the setting, the faster the speed.

Settings: 0 – 63

Voice Mode

Voice Play

- [F1] PLAY
- [F3] PORTA
- [F4] EG
- [F5] ARP ED
- [F6] EFFECT

Arpeggio Edit

- [F2] TYPE
- [F3] MAIN
- [F4] LIMIT
- [F5] PLAY FX

Normal Voice Edit

Common Edit

- [F1] GENERAL
- [F2] OUTPUT
- [F3] EQ
- [F4] CTL SET
- [F5] LFO
- [F6] EFFECT

Element Edit

- [F1] OSC
- [F2] PITCH
- [F3] FILTER
- ▶ [F4] AMP
- ▶ [F5] LFO
- [F6] EQ

Drum Voice Edit

Common Edit

- [F1] GENERAL
- [F2] OUTPUT
- [F3] EQ
- [F4] CTL SET
- [F6] EFFECT

Key Edit

- [F1] OSC
- [F2] PITCH
- [F3] FILTER
- [F4] AMP
- [F6] EQ

Voice Job

- [F1] INIT
- [F2] RECALL
- [F3] COPY
- [F4] BULK

Supplementary Information

KeyOnReset

Determines whether or not the LFO is reset each time a note is played.

Settings: off, on

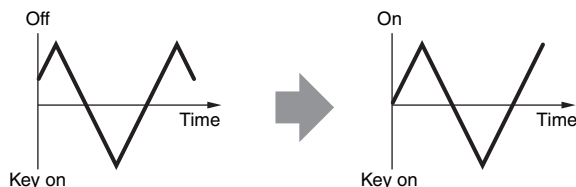

KeyOnDelay

Determines the delay time between the moment that a Note On message is received and the moment the LFO comes into effect.

Settings: 0 – 127

PMod (Pitch Modulation Depth)

Determines the amount (depth) by which the LFO waveform varies (modulates) the pitch of the sound.

Settings: 0 – 127

FMod (Filter Modulation Depth)

Determines the amount (depth) by which the LFO waveform varies (modulates) the Filter Cutoff frequency.

Settings: 0 – 127

AMod (Amplitude Modulation Depth)

Determines the amount (depth) by which the LFO waveform varies (modulates) the amplitude or volume of the sound.

Settings: 0 – 127

FadeInTime

Determines the amount of time for the LFO effect to fade in (after the “KeyOnDelay” time has elapsed).

Settings: 0 – 127

[F6] EQ (Equalizer)

Type

Determines the Equalizer Type.

Settings: 2 Band, P.EQ (Parametric EQ), Boost6 (boost 6dB), Boost12 (boost 12dB), Boost18 (boost 18dB), thru 2 Band This is a “shelving” equalizer, which combines separate high and low frequency bands. P.EQ (Parametric EQ) The Parametric EQ is used to attenuate or boost signal levels (gain) around the Frequency. This type features 32 different “Q” settings, which determine the frequency band width of the equalizer. Boost6 (boost 6dB)/Boost12 (boost 12dB)/Boost18 (boost 18dB) These can be used to boost the level of the entire signal by 6dB, 12dB and 18dB, respectively. thru This setting bypasses the equalizers leaving the entire signal unaffected.

When set to 2 Band

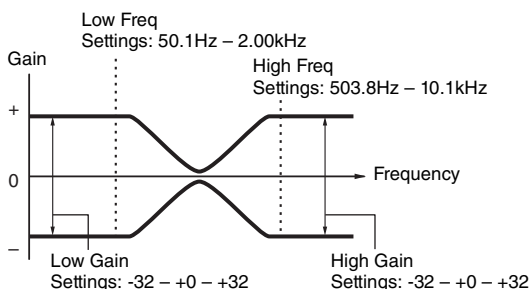

When set to P.EQ

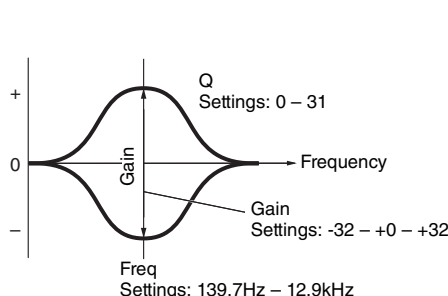

Voice Mode

Voice Play

- [F1] PLAY
- [F3] PORTA
- [F4] EG
- [F5] ARP ED
- [F6] EFFECT

Arpeggio Edit

- [F2] TYPE
- [F3] MAIN
- [F4] LIMIT
- [F5] PLAY FX

Normal Voice Edit

Common Edit

- [F1] GENERAL
- [F2] OUTPUT
- [F3] EQ
- [F4] CTL SET
- [F5] LFO
- [F6] EFFECT

Element Edit

- [F1] OSC
- [F2] PITCH
- [F3] FILTER
- [F4] AMP
- [F5] LFO
- [F6] EQ

Drum Voice Edit

Common Edit

- [F1] GENERAL
- [F2] OUTPUT
- [F3] EQ
- [F4] CTL SET
- [F6] EFFECT

Key Edit

- [F1] OSC
- [F2] PITCH
- [F3] FILTER
- [F4] AMP
- [F6] EQ

Voice Job

- [F1] INIT
- [F2] RECALL
- [F3] COPY
- [F4] BULK

Supplementary Information

Drum Voice Edit

Each Drum Voice can consist of up to 73 Drum Keys, assigned to notes spread across the keyboard (C0 to C6). There are two types of Drum Voice Edit: those for Common Edit to edit the settings common to all keys, and those for Key Edit to edit individual keys. This section explains the parameters for Common Edit and Key Edit.

Common Edit

Operation

[VOICE] → Drum Voice selection → [EDIT] → [COMMON]

[F1] GENERAL

[SF1] NAME

[SF4] OTHER

This is the same as in Normal Voice Common Edit. See [page 30](#).

[F2] OUTPUT

Same as in Normal Voice Common Edit. See [page 31](#)). In addition, the following two parameters are also available.

InsChoSend (Insertion Chorus Send)

Determines the Send level for the entire Drum voice (all keys), sent from Insertion Effect A/B or Vocoder to the Chorus effect.

Settings: 0 – 127

InsRevSend (Insertion Reverb Send)

Determines the Send level for the entire Drum voice (all keys), sent from Insertion Effect A/B or Vocoder to the Reverb effect.

Settings: The setting of the “InsChoSend” or “InsRevSend” is common to all keys. When you set the drum key so that the Insertion A/B or Vocoder is bypassed, the Chorus /Reverb Send Level can be set individually for each drum key. Also, the above parameter does not affect the key. In that case, you can set the Chorus/Reverb Send Level for each key in the “ChoSend”/“RevSend” in the [SF2] OUTPUT display of the [F1] OSC display in Key edit.

[F3] EQ

This is the same as in Normal Voice Common Edit. See [page 32](#).

[F4] CTL SET (Controller Set)

This is the same as in Normal Voice Common Edit. See [page 32](#). Please note that the Element Switch parameter is not available in Drum Voice Common Edit.

Voice Mode

Voice Play

[F1] PLAY
[F3] PORTA
[F4] EG
[F5] ARP ED
[F6] EFFECT

Arpeggio Edit

[F2] TYPE
[F3] MAIN
[F4] LIMIT
[F5] PLAY FX

Normal Voice Edit

Common Edit

[F1] GENERAL
[F2] OUTPUT
[F3] EQ
[F4] CTL SET
[F5] LFO
[F6] EFFECT

Element Edit

[F1] OSC
[F2] PITCH
[F3] FILTER
[F4] AMP
[F5] LFO
[F6] EQ

Drum Voice Edit

Common Edit

▶ [F1] GENERAL
▶ [F2] OUTPUT
▶ [F3] EQ
▶ [F4] CTL SET
[F6] EFFECT

Key Edit

[F1] OSC
[F2] PITCH
[F3] FILTER
[F4] AMP
[F6] EQ

Voice Job

[F1] INIT
[F2] RECALL
[F3] COPY
[F4] BULK

Supplementary Information

[F6] EFFECT

This is the same as in Normal Voice Common Edit. See [page 35](#). Please note that the “EL: OUT” (Element Out) parameter in the [SF1] CONNECT display is not available.

KEY: OUT

Determines which Insertion Effect (A or B) is used to process each individual Drum Key, and which is bypassed (thru). When the “InsEF Connect” (Insertion Effect Connection) is set to “vocoder,” the output is specified even if “EL: OUT” is set to either “insA” or “insB.”

Settings: thru, insA (insertion A), insB (insertion B)

Key Edit

Operation

[VOICE] → Drum Voice selection → [EDIT] → Key selection

[F1] OSC (Oscillator)

[SF1] WAVE

From this display you can select the desired wave or Normal voice used for the individual Drum key.

KEY

Determines the desired drum key. You can select the desired percussion instrument by pressing the note.

Settings: C0 – C6

ElementSw (Element Switch)

Determines whether the currently selected key is on or off, or in other words, whether the wave for the key is active or inactive.

Settings: off, on

WaveBank

Determines the Waveform Bank assigned to the Element.

Settings: pre, user

WaveCategory (Waveform Category)

WaveNumber (Waveform Number)

Determines the Waveform assigned to the Drum Key by selecting the Waveform Category and Number.

Settings: See the “Waveform List” in the “Data List” PDF document.

[SF2] OUTPUT

From this display you can set certain output parameters for the selected Drum key.

InsEffOut (Insertion Effect Output)

Determines which Insertion Effect (A or B) is used to process each individual Drum key. The Insertion Effect is bypassed if “thru” is selected. This parameter is same as the “KEY: OUT” parameter of the [F6] EFFECT display in Voice Common Edit. Making a setting here automatically changes the setting of that parameter as well.

Settings: thru, insA (Insertion Effect A), insB (Insertion Effect B)

RevSend (Reverb Send)

Determines the level of the Drum key sound (the bypassed signal) that is sent to Reverb effect. This is available only when “InsEffOut” (above) is set to “thru.”

Settings: 0 – 127

ChoSend (Chorus Send)

Determines the level of the Drum key sound (the bypassed signal) that is sent to the Chorus effect. This is available only when Insertion Effect Output (above) is set to “thru.”

Settings: 0 – 127

Voice Mode

Voice Play

- [F1] PLAY
- [F3] PORTA
- [F4] EG
- [F5] ARP ED
- [F6] EFFECT

Arpeggio Edit

- [F2] TYPE
- [F3] MAIN
- [F4] LIMIT
- [F5] PLAY FX

Normal Voice Edit

Common Edit

- [F1] GENERAL
- [F2] OUTPUT
- [F3] EQ
- [F4] CTL SET
- [F5] LFO
- [F6] EFFECT

Element Edit

- [F1] OSC
- [F2] PITCH
- [F3] FILTER
- [F4] AMP
- [F5] LFO
- [F6] EQ

Drum Voice Edit

Common Edit

- [F1] GENERAL
- [F2] OUTPUT
- [F3] EQ
- [F4] CTL SET
- ▶ [F6] EFFECT

Key Edit

- ▶ [F1] OSC
- [F2] PITCH
- [F3] FILTER
- [F4] AMP
- [F6] EQ

Voice Job

- [F1] INIT
- [F2] RECALL
- [F3] COPY
- [F4] BULK

Supplementary Information

[SF4] OTHER

From this display you can set various parameters related to how the individual notes of the Drum voice respond to the keyboard and MIDI data.

AssignMode

Determines the playing method when the same notes are received continuously over the same channel, and without a corresponding note off message. For details on settings, see the "Synthesizer Parameter Manual" PDF document.

Settings: single, multi

RcvNoteOff (Receive Note Off)

Select whether MIDI Note Off messages are received by each Drum Key.

Settings: off, on

AltnateGroup (Alternate Group)

Set the Alternate Group to which the key is assigned. This setting helps to reproduce the sounds of a real drum kit, in which some drum sounds cannot physically be played simultaneously, such as open and closed hi-hats.

Settings: off, 1 – 127

[SF6] HOLD

In the Key Edit displays, the desired Drum Key can be changed by pressing a key on the keyboard. When setting this [SF6] HOLD to on (**HOLD ON**), the desired Drum Key is maintained even when pressing any other keys on the keyboard. When setting the [SF6] HOLD to off (**HOLD OFF**), the desired Drum Key can be changed by pressing another key on the keyboard.

[F2] PITCH

[SF1] TUNE

From this display you can set various pitch-related parameters for the selected key.

Coarse (Coarse Tuning)

Determines the pitch of each Drum Key Wave in semitones.

Settings: -48 – +0 – +48

Fine (Fine Tuning)

Determines the fine tuning for the pitch of each Drum Key Wave.

Settings: -64 – +0 – +63

[SF2] VEL SENS (Velocity Sensitivity)

Pitch (Pitch Velocity Sensitivity)

Determines how the pitch of the selected Drum key responds to velocity.

Settings: -64 – +0 – +63

Voice Mode

Voice Play

- [F1] PLAY
- [F3] PORTA
- [F4] EG
- [F5] ARP ED
- [F6] EFFECT

Arpeggio Edit

- [F2] TYPE
- [F3] MAIN
- [F4] LIMIT
- [F5] PLAY FX

Normal Voice Edit

Common Edit

- [F1] GENERAL
- [F2] OUTPUT
- [F3] EQ
- [F4] CTL SET
- [F5] LFO
- [F6] EFFECT

Element Edit

- [F1] OSC
- [F2] PITCH
- [F3] FILTER
- [F4] AMP
- [F5] LFO
- [F6] EQ

Drum Voice Edit

Common Edit

- [F1] GENERAL
- [F2] OUTPUT
- [F3] EQ
- [F4] CTL SET
- [F6] EFFECT

Key Edit

- ▶ [F1] OSC
- ▶ [F2] PITCH
- [F3] FILTER
- [F4] AMP
- [F6] EQ

Voice Job

- [F1] INIT
- [F2] RECALL
- [F3] COPY
- [F4] BULK

Supplementary Information

[F3] FILTER**[SF1] CUTOFF**

You can apply filter settings to the Drum Voice. The MOXF6/MOXF8 lets you apply a low pass filter and high pass filter to each individual Drum key.

LPFCutoff (Low Pass Filter Cutoff)

Use this parameter to set a cutoff frequency for the low-pass filter.

Settings: 0 – 255

LPFReso (Low Pass Filter Resonance)

Determines the amount of Resonance (harmonic emphasis) applied to the signal at the Cutoff Frequency.

Settings: 0 – 127

HPFCutoff (High Pass Filter Cutoff)

Determines the Cutoff frequency of the High Pass Filter.

Settings: 0 – 255

[SF2] VEL SENS (Velocity Sensitivity)**LPFCutoff (Low Pass Filter Cutoff)**

Set the velocity sensitivity of the Low Pass Filter Cutoff frequency. Positive settings will cause the Cutoff Frequency to rise the harder you play the keyboard. A negative setting will have the opposite effect.

Settings: -64 – +0 – +63

[F4] AMP (Amplitude)**[SF1] LVL/PAN (Level/Pan)**

This display not only lets you make basic Level and Pan settings for the sound of each individual Drum key, it also gives you some detailed and unusual parameters for affecting Pan position.

Level

Determines the output for the selected Drum key (Wave). This lets you make detailed balance adjustments among the various sounds of the Drum voice.

Settings: 0 – 127

Pan

Sets the pan position (stereo position) of each wave. This will also be used as the basic Pan position for the Alternate and Random settings.

Settings: L63 (far left) – C (center) – R63 (far right)

AlternatePan

Determines the amount by which the sound of the selected Drum key is panned alternately left and right for each note you press. The Pan setting (above) is used as the basic Pan position.

Settings: L64 – C – R63

RandomPan

Determines the amount by which the sound of the selected Drum Key is panned randomly left and right for each note you press. The Pan setting (above) is used as the Center Pan position.

Settings: 0 – 127

[SF2] VEL SENS (Velocity Sensitivity)**Level (Level Velocity Sensitivity)**

Determines the velocity sensitivity of the Amplitude Envelope Generator's output level.

Settings: -64 – +0 – +63

Voice Mode**Voice Play**

[F1] PLAY
[F3] PORTA
[F4] EG
[F5] ARP ED
[F6] EFFECT

Arpeggio Edit

[F2] TYPE
[F3] MAIN
[F4] LIMIT
[F5] PLAY FX

Normal Voice Edit**Common Edit**

[F1] GENERAL
[F2] OUTPUT
[F3] EQ
[F4] CTL SET
[F5] LFO
[F6] EFFECT

Element Edit

[F1] OSC
[F2] PITCH
[F3] FILTER
[F4] AMP
[F5] LFO
[F6] EQ

Drum Voice Edit**Common Edit**

[F1] GENERAL
[F2] OUTPUT
[F3] EQ
[F4] CTL SET
[F6] EFFECT

Key Edit

[F1] OSC
[F2] PITCH
▶ [F3] FILTER
▶ [F4] AMP
[F6] EQ

Voice Job

[F1] INIT
[F2] RECALL
[F3] COPY
[F4] BULK

Supplementary Information

[SF3] AEG (Amplitude EG)**AttackTime**

Settings: 0 – 127

Decay1Time

Settings: 0 – 127

Decay1Level

Settings: 0 – 127

Decay2Time

Settings: 0 – 126, hold

Decay 2 Time = 0 – 126

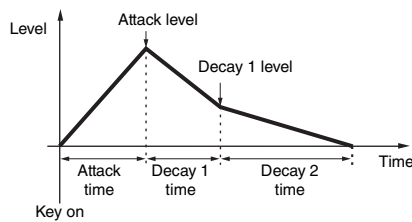

Decay 2 Time = hold

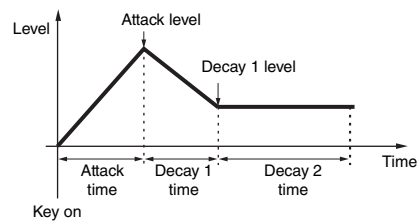
**[F6] EQ (Equalizer)**Same as in Normal Element Edit. See [page 46](#).**Voice Mode****Voice Play**

- [F1] PLAY
- [F3] PORTA
- [F4] EG
- [F5] ARP ED
- [F6] EFFECT

Arpeggio Edit

- [F2] TYPE
- [F3] MAIN
- [F4] LIMIT
- [F5] PLAY FX

Normal Voice Edit**Common Edit**

- [F1] GENERAL
- [F2] OUTPUT
- [F3] EQ
- [F4] CTL SET
- [F5] LFO
- [F6] EFFECT

Element Edit

- [F1] OSC
- [F2] PITCH
- [F3] FILTER
- [F4] AMP
- [F5] LFO
- [F6] EQ

Drum Voice Edit**Common Edit**

- [F1] GENERAL
- [F2] OUTPUT
- [F3] EQ
- [F4] CTL SET
- [F6] EFFECT

Key Edit

- [F1] OSC
- [F2] PITCH
- [F3] FILTER
- ▶ [F4] AMP
- ▶ [F6] EQ

Voice Job

- [F1] INIT
- [F2] RECALL
- [F3] COPY
- [F4] BULK

Supplementary Information

Voice Job

Voice Job features several basic operations, such as Initialize and Copy. After setting parameters as required in the selected display, press the [ENTER] button to execute the Job.

Operation

[VOICE] → Voice selection → [JOB]

[F1] INIT (Initialize)

This resets (initializes) all Voice parameters to their default settings. It also allows you to selectively initialize certain parameters, such as Common settings, settings for each Element/Drum key, and so on—very useful when creating a completely new voice from scratch.

Parameter Type to be initialized

ALL: All data in Common Edit and Element (Key) Edit

Common: Data in Common Edit

EL: Data of the corresponding Element Edit (or Key Edit) parameters

with WaveNo.: If this is checked, the Wave Bank/Wave Number assigned to the Elements (Keys) will be initialized.

NOTE In order to select “Common” or “EL,” the “ALL” box must be unchecked.

NOTE If you turn the check mark on when a Drum voice is selected, you can select a Drum key.

[F2] RECALL (Edit Recall)

If you are editing a Voice and select a different Voice without storing your edited one, all the edits you've made will be erased. If this happens, you can use Edit Recall to restore the Voice with your latest edits intact.

[F3] COPY

From this display you can copy Common and Element/Drum Key parameter settings from any Voice to the Voice you are editing. This is useful if you are creating a Voice and wish to use some parameter settings from another Voice.

Data type to be copied (Type)

Common: Data in the Common Edit

Element (1 – 8): Data of the corresponding Element Edit parameters

Key C0 – C6: Data of the corresponding Key Edit parameters

Copy procedure

1. Select the Source Voice.
When “Current” is selected in the Source Voice, the Source Voice will be same as the Destination Voice. If you wish to copy one Element to another Element in the same Voice, select “Current.”
2. Select the Destination Voice (Current Voice).
3. When “Element” or “Key” is selected in the Source Voice, select the Part/Key to be copied in the Destination Voice.
4. Press the [ENTER] button.

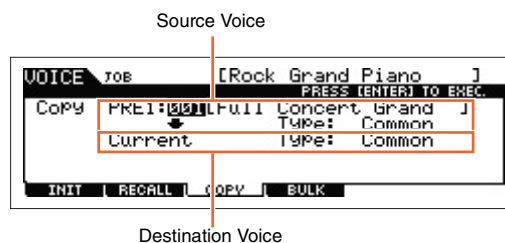

[F4] BULK (Bulk Dump)

Allows you to send all your edited parameter settings for the currently selected Voice to a computer or another MIDI instrument for data archiving. Press the [ENTER] button to execute the Bulk Dump.

NOTE In order to execute Bulk Dump, you will need to set the correct MIDI Device Number, with the following operation: [UTILITY] → [F6] MIDI → [SF1] CH → DeviceNo.

Voice Mode

Voice Play

- [F1] PLAY
- [F3] PORTA
- [F4] EG
- [F5] ARP ED
- [F6] EFFECT

Arpeggio Edit

- [F2] TYPE
- [F3] MAIN
- [F4] LIMIT
- [F5] PLAY FX

Normal Voice Edit

Common Edit

- [F1] GENERAL
- [F2] OUTPUT
- [F3] EQ
- [F4] CTL SET
- [F5] LFO
- [F6] EFFECT

Element Edit

- [F1] OSC
- [F2] PITCH
- [F3] FILTER
- [F4] AMP
- [F5] LFO
- [F6] EQ

Drum Voice Edit

Common Edit

- [F1] GENERAL
- [F2] OUTPUT
- [F3] EQ
- [F4] CTL SET
- [F6] EFFECT

Key Edit

- [F1] OSC
- [F2] PITCH
- [F3] FILTER
- [F4] AMP
- [F6] EQ

Voice Job

- ▶ [F1] INIT
- ▶ [F2] RECALL
- ▶ [F3] COPY
- ▶ [F4] BULK

Supplementary Information

Supplementary Information

■ Voice Category List

This is the list of the Main Categories and their Sub Categories to which the respective Voices of the MOXF6/MOXF8 belong.

Main Category (abbreviation)	Sub Category (abbreviation)						
	All	Acoustic Piano	Layer	Modern	Vintage	Arpeggio	---
Acoustic Piano (Pn)	All	Acoustic Piano	Layer	Modern	Vintage	Arpeggio	---
Keyboard (Kb)	All	Electric Piano	FM Piano	Clavi	Synth	Arpeggio	---
Organ (Or)	All	Tone Wheel	Combo	Pipe	Synth	Arpeggio	---
Guitar (Gt)	All	Acoustic Guitar	Electric Clean	Electric Distortion	Synth	Arpeggio	---
Bass (Bs)	All	Acoustic Bass	Electric Bass	Synth Bass	Arpeggio	---	---
Strings (St)	All	Solo	Ensemble	Pizzicato	Synth	Arpeggio	---
Brass (Br)	All	Solo	Brass Ensemble	Orchestra	Synth	Arpeggio	---
Sax/Woodwind (SW)	All	Saxophone	Flute	Woodwind	Reed / Pipe	Arpeggio	---
Synth Lead (Ld)	All	Analog	Digital	Hip Hop	Dance	Arpeggio	---
Synth Pad/Choir (Pd)	All	Analog	Warm	Bright	Choir	Arpeggio	---
Synth Comping (Sc)	All	Analog	Digital	Fade	Hook	Arpeggio	---
Chromatic Percussion (Cp)	All	Mallet Percussion	Bell	Synth Bell	Pitched Drum	Arpeggio	---
Drum/Percussion (Dr)	All	Drums	Percussion	Synth	Arpeggio	---	---
Sound Effect (Se)	All	Moving	Ambient	Nature	Sci-Fi	Arpeggio	---
Musical Effect (Me)	All	Moving	Ambient	Sweep	Hit	Arpeggio	---
Ethnic (Et)	All	Bowed	Plucked	Struck	Blown	Arpeggio	---
Vocoder (Vc)	---						
No Assign	---						

■ Setting examples of the Destination

In this section, we'll show you some useful examples how to set the "Dest" (Destination) assignments of the CTL SET display in the Voice Common Edit parameters

To control the volume:	Volume
To apply vibrato to the Voice:	Common LFO Depth1 - 3 (CLFO-D1 - 3) ^{*1}
To change the pitch:	Element Pitch (PCH-Crs) ^{*2}
To control the brightness of the Voice:	Element Filter Frequency (FLT-Frq) ^{*2}
To change the speed of the Rotary Speaker:	Insertion A/B Parameter 1 (INSA/INSB: EfLfoSp) ^{*3}
To apply a wah pedal effect to the Voice:	Insertion A/B Parameter 1 (ins A/B Pedal Ctrl) ^{*4}

Concerning *1 - *4, the following settings are necessary in addition to the above settings.

- *1 "Play Mode" = "loop" in the [SF1] WAVE display of the [F5] LFO display of the Voice Common Edit
"Dest" (Control Destination 1 - 3) = "Pmod" in the [SF4] BOX display of the [F5] LFO display of Voice Common Edit.
- *2 "ElmSw" (Controller Set Element Switch) = on
- *3 "InsA/B Type" = "Rotary Sp" in the [F6] EFFECT display of Voice Common Edit
"EL: OUT" / "KEY: OUT" = "INSA"/"INSB" (assigned to "Rotary Speaker" Type) in the [F6] EFFECT display of Voice Common Edit
- *4 "InsA/B Type" = "VCM Pedal Wah" in the [F6] EFFECT display of Voice Common Edit
"EL: OUT" / "KEY: OUT" = "INSA"/"INSB" (assigned to "VCM Pedal Wah" Type) in the [F6] EFFECT display of Voice Common Edit

Voice Mode

Voice Play

- [F1] PLAY
- [F3] PORTA
- [F4] EG
- [F5] ARP ED
- [F6] EFFECT

Arpeggio Edit

- [F2] TYPE
- [F3] MAIN
- [F4] LIMIT
- [F5] PLAY FX

Normal Voice Edit

Common Edit

- [F1] GENERAL
- [F2] OUTPUT
- [F3] EQ
- [F4] CTL SET
- [F5] LFO
- [F6] EFFECT

Element Edit

- [F1] OSC
- [F2] PITCH
- [F3] FILTER
- [F4] AMP
- [F5] LFO
- [F6] EQ

Drum Voice Edit

Common Edit

- [F1] GENERAL
- [F2] OUTPUT
- [F3] EQ
- [F4] CTL SET
- [F6] EFFECT

Key Edit

- [F1] OSC
- [F2] PITCH
- [F3] FILTER
- [F4] AMP
- [F6] EQ

Voice Job

- [F1] INIT
- [F2] RECALL
- [F3] COPY
- [F4] BULK

Supplementary Information

■ Functions of Knobs 1 – 8

This section explains the functions assigned to Knobs 1 – 8 in the Voice mode. For instructions, see the Owner's Manual.

When the [TONE 1] lamp is turned on:

Knob 1	CUTOFF	[VOICE] → [F4] EG → FEG "CUTOFF"	page 26
Knob 2	RESONANCE	[VOICE] → [F4] EG → FEG "RESO"	page 26
Knob 3	FEG DEPTH	[VOICE] → [F4] EG → FEG "DEPTH"	page 26
Knob 4	PORTAMENTO	[VOICE] → [F3] PORTA → "PortaTime"	page 26

When the [TONE 2] lamp is turned on:

Knob 1	ATTACK	[VOICE] → [F4] EG → AEG "ATK"	page 26
Knob 2	DECAY	[VOICE] → [F4] EG → AEG "DCY"	page 26
Knob 3	SUSTAIN	[VOICE] → [F4] EG → AEG "SUS"	page 26
Knob 4	RELEASE	[VOICE] → [F4] EG → AEG "REL"	page 26

When the [TONE 3] lamp is turned on:

Knob 1	VOLUME	[VOICE] → [EDIT] → [COMMON] → [F2] OUTPUT → "Volume"	page 31
Knob 2	PAN	[VOICE] → [EDIT] → [COMMON] → [F2] OUTPUT → "Pan"	page 31
Knob 3	ASSIGN 1	[VOICE] → [EDIT] → [COMMON] → [F4] CTL SET → function that is set in "Dest" when "Source" is set to "AS1"/"AS2"	page 32
Knob 4	ASSIGN 2		

When the [EQ] lamp is turned on:

Knob 5	LOW	[VOICE] → [EDIT] → [COMMON] → [F3] EQ → "LOW GAIN"	page 32
Knob 6	MID F	[VOICE] → [EDIT] → [COMMON] → [F3] EQ → "MID FREQ"	
Knob 7	MID	[VOICE] → [EDIT] → [COMMON] → [F3] EQ → "MID GAIN"	
Knob 8	HIGH	[VOICE] → [EDIT] → [COMMON] → [F3] EQ → "HIGH GAIN"	

When the [EFFECT] lamp is turned on:

Knob 5	CHO PRESET	[VOICE] → [F6] EFFECT → [SF4] CHORUS → "Preset"	page 36
Knob 6	CHO SEND	[VOICE] → [F6] EFFECT → [SF1] CONNECT → "Chorus Send"	page 35
Knob 7	REV PRESET	[VOICE] → [F6] EFFECT → [SF5] REVERB → "Preset"	page 36
Knob 8	REV SEND	[VOICE] → [F6] EFFECT → [SF1] CONNECT → "Reverb Send"	page 35

When the [ARP] lamp is turned on:

Knob 5	GATE TIME	[VOICE] → ARP [EDIT] → [F5] PLY FX → "GateTimeRate"	page 28
Knob 6	OCT RANGE	[VOICE] → ARP [EDIT] → [F5] PLY FX → "OctaveRange"	page 29
Knob 7	UNITMULTIPLY	[VOICE] → ARP [EDIT] → [F5] PLY FX → "UnitMultiply"	page 28
Knob 8	TEMPO	[VOICE] → ARP [EDIT] → [F3] MAIN → "Tempo"	page 27

Voice Mode

Voice Play

- [F1] PLAY
- [F3] PORTA
- [F4] EG
- [F5] ARP ED
- [F6] EFFECT

Arpeggio Edit

- [F2] TYPE
- [F3] MAIN
- [F4] LIMIT
- [F5] PLAY FX

Normal Voice Edit

Common Edit

- [F1] GENERAL
- [F2] OUTPUT
- [F3] EQ
- [F4] CTL SET
- [F5] LFO
- [F6] EFFECT

Element Edit

- [F1] OSC
- [F2] PITCH
- [F3] FILTER
- [F4] AMP
- [F5] LFO
- [F6] EQ

Drum Voice Edit

Common Edit

- [F1] GENERAL
- [F2] OUTPUT
- [F3] EQ
- [F4] CTL SET
- [F6] EFFECT

Key Edit

- [F1] OSC
- [F2] PITCH
- [F3] FILTER
- [F4] AMP
- [F6] EQ

Voice Job

- [F1] INIT
- [F2] RECALL
- [F3] COPY
- [F4] BULK

Supplementary Information

Performance Mode

The Performance mode is used for selecting, playing, and editing the desired Performance. Performances can be made up of a maximum of four Parts (Voices), selected from the internal tone generator Parts 1 – 4. This section explains each parameter in four types (Performance Play, Performance Edit, Performance Job, and Performance Record).

Performance Play

Performance Play is the main “portal” by which you enter the Performance mode, and it is here where you select and play a Performance.

Operation

Press the [PERFORM] button.

[F1] PLAY



Performance Play display

1 Performance Bank

2 Performance Number

Indicates the Bank and Number of the selected Performance.

3 Favorite Category indicator

When setting the currently selected Performance to the Favorite category, this indicator will appear.

4 Category

Indicates the Main category and Sub category of the currently selected Performance.

5 TCH (Transmit Channel)

Indicates the Keyboard MIDI transmit channel. You can change the Keyboard MIDI transmit channel by pressing the [TRACK] button so that its indicator lights and pressing any of the Number [1] – [16] buttons. The Keyboard MIDI transmit channel can be changed also with the following operation: [UTILITY] → [F6] MIDI → [SF1] CH → “KBDTransCh.”

6 J (Arpeggio Tempo)

Indicates the arpeggio tempo set for the currently selected Performance.

NOTE This parameter can be set also by holding the [SHIFT] button and pressing the [ENTER] button several times repeatedly at the desired tempo. This function is referred to as “Tap Tempo.”

7 OCT (Octave)

Indicates the Keyboard Octave setting.

[SF1] ARP1 (Arpeggio 1) – [SF6] ARP6 (Arpeggio 6)

The Arpeggio types are assigned to the buttons with 8th note icons on the display tab. You can call them up by pressing these buttons any time during your keyboard performance. The Arpeggio Type can be set in the Arpeggio Edit display (page 57).

Performance Mode

Performance Play

- ▶ [F1] PLAY
- [F2] VOICE
- [F3] PORTA
- [F4] EG
- [F5] ARP ED
- [F6] EFFECT

Arpeggio Edit

- [F1] COMMON
- [F2] TYPE
- [F3] MAIN
- [F4] LIMIT
- [F5] PLAY FX
- [F6] OUT CH

Performance Edit

Common Edit

- [F1] GENERAL
- [F2] OUT/MFX
- [F3] MEQ
- [F4] USB I/O
- [F5] A/D IN
- [F6] EFFECT

Part Edit

- [F1] VOICE
- [F2] OUTPUT
- [F3] EQ
- [F4] TONE
- [F5] RCV SW

Performance Job

- [F1] INIT
- [F2] RECALL
- [F3] COPY
- [F4] BULK

Performance Record

- [F1] SETUP
- [F2] REC TR
- [F3] OTHER
- [F5] CLICK
- [F6] INFO

Supplementary Information

[F2] VOICE

From this mode you can select a Voice for each Part and determine the note range it can be played from.

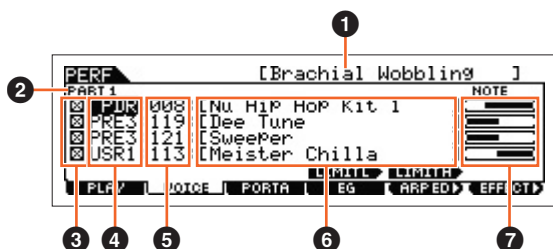

1 Performance Name

Indicates the selected Performance name.

2 Part

Indicates the selected part.

3 Part Switch

Determines whether the Part is used (on) or not used (off). Setting this parameter to on () enables the Part to sound. Meanwhile, setting this parameter to off () disables sound for the Part, and the Part indication will disappear from the VOICE display.

4 Voice Bank

5 Voice Number

6 Voice Name

Indicates the bank and number of the Voices assigned to Parts 1 – 4.

7 Note Limit

Determines the lowest and highest notes in the Part's note range. Simultaneously hold down [SF4] LIMIT L (Limit Low) and press the desired key on the keyboard to set the note. This sets the lowest note of the range over which the Voice of the selected Part sounds. Simultaneously hold down [SF5] LIMIT H (Limit High) and press the desired key on the keyboard to set the note. This sets the highest note of the range over which the voice of the selected part sounds. You can also create a lower and an upper range for the Voice, with a note range "hole" in the middle, by specifying the highest note first. For example, setting a Note Limit of "C5 – C4" lets you play the Voice from two separate ranges: C -2 to C4 and C5 to C8. Notes played between C4 and C5 do not play the selected Voice

[F3] PORTA (Portamento)

PortaSw (Portamento Switch)

Determines whether Portamento is on or off for all Parts.

Settings: off, on

PortaTime (Portamento Time) Knob

Determines the pitch transition time or rate when Portamento is applied. The settings are applied as offsets to same parameter in Performance Part Edit ([page 65](#)).

Settings: 0 – 127

PartSwitch

Determines whether Portamento is on or off for each individual Part. This is available only when the PortaSw (above) is set to on.

[F4] EG

This display contains the basic EG settings, both volume and filter. The settings made here are applied as offsets to the AEG and FEG settings in the Performance Part Edit ([page 68](#)). The parameters are the same as in the [F4] EG display of Voice Play. See [page 26](#).

Performance Mode

Performance Play

- [F1] PLAY
- [F2] VOICE
- [F3] PORTA
- [F4] EG
- [F5] ARP ED
- [F6] EFFECT

Arpeggio Edit

- [F1] COMMON
- [F2] TYPE
- [F3] MAIN
- [F4] LIMIT
- [F5] PLAY FX
- [F6] OUT CH

Performance Edit

Common Edit

- [F1] GENERAL
- [F2] OUT/MFX
- [F3] MEQ
- [F4] USB I/O
- [F5] A/D IN
- [F6] EFFECT

Part Edit

- [F1] VOICE
- [F2] OUTPUT
- [F3] EQ
- [F4] TONE
- [F5] RCV SW

Performance Job

- [F1] INIT
- [F2] RECALL
- [F3] COPY
- [F4] BULK

Performance Record

- [F1] SETUP
- [F2] REC TR
- [F3] OTHER
- [F5] CLICK
- [F6] INFO

Supplementary Information

[F5] ARP ED (Arpeggio Edit)

Pressing this button calls up the Arpeggio Edit display of the Performance mode.

[F6] EFFECT

Pressing this button calls up the EFFECT display (page 63) of Performance Common Edit.

Arpeggio Edit

This display contains the basic settings for Arpeggio playback, including Type and Tempo in the Performance mode. The MOXF6/MOXF8 has four arpeggiators. In the Performance mode, the different Arpeggio types can be assigned to up to four parts, and the up to four arpeggio types can be simultaneously played. The parameters are the same as in the Voice mode (page 27), except for the following parameters.

Operation

[PERFORM] → Performance selection → [F5] ARP ED
Performance mode → ARP [EDIT]

[F1] COMMON

Tempo (Arpeggio Tempo) Knob

Determines the tempo for the Arpeggio.

Settings: 5 – 300

NOTE If you are using this instrument with an external sequencer, DAW software, or MIDI device, and you want to synchronize it with that device, set the “MIDI Sync” parameter in the MIDI display of the Utility mode (page 148) to “external” or “auto.” When “MIDI Sync” is set to “auto” (only when MIDI clock is transmitted continuously) or “external,” the Tempo parameter here indicates “external” and cannot be changed.

NOTE This parameter can be set also by holding the [SHIFT] button and pressing the [ENTER] button several times repeatedly at the desired tempo. This function is referred to as “Tap Tempo.”







Switch (Common Switch)

Determines whether Arpeggio is on or off for all Parts. This setting is applied to the ARP [ON/OFF] button on the panel.

Settings: off, on

SyncQtzValue (Sync Quantize Value)

Determines the actual timing at which the next Arpeggio playback starts when you trigger it while the Arpeggio of a certain Part is played back. When set to “off,” the next Arpeggio starts as soon as you trigger it. The number shown at right of each value indicates the resolution of the 1/4 note in clocks.

Settings: off,  60 (32nd note),  80 (16th note triplet),  120 (16th note),  160 (8th note triplet),  240 (8th note),  320 (1/4 note triplet),  480 (1/4 note)

QtzStrength (Quantize Strength)

Determines the offset value for “QtzStrength” in the [F5] PLAY FX display. This parameter is applied to all parts.

Settings: -100 – +0 – +100

VelocityRate

Determines the offset value for “VelocityRate” in the [F5] PLAY FX display. This parameter is applied to all parts.

Settings: -100 – +0 – +100

GateTimeRate Knob

Determines the offset value for “GateTimeRate” in the [F5] PLAY FX display. This parameter is applied to all parts.

Settings: -100 – +0 – +100

Swing

Determines the offset value for “Swing” in the [F5] PLAY FX display. This parameter is applied to all parts.

Settings: -120 – +0 – +120

Performance Mode

Performance Play

[F1] PLAY
[F2] VOICE
[F3] PORTA
[F4] EG
▶ [F5] ARP ED
▶ [F6] EFFECT

Arpeggio Edit

▶ [F1] COMMON
[F2] TYPE
[F3] MAIN
[F4] LIMIT
[F5] PLAY FX
[F6] OUT CH

Performance Edit

Common Edit

[F1] GENERAL
[F2] OUT/MFX
[F3] MEQ
[F4] USB I/O
[F5] A/D IN
[F6] EFFECT

Part Edit

[F1] VOICE
[F2] OUTPUT
[F3] EQ
[F4] TONE
[F5] RCV SW

Performance Job

[F1] INIT
[F2] RECALL
[F3] COPY
[F4] BULK

Performance Record

[F1] SETUP
[F2] REC TR
[F3] OTHER
[F5] CLICK
[F6] INFO

Supplementary Information

[F2] TYPE

These are the same as in the Arpeggio Edit display (page 27) of the Voice mode.

[F3] MAIN

These are the same as in the Arpeggio Edit display (page 27) of the Voice mode. However the “Tempo” parameter is not in the MAIN display of the Performance mode, and the following parameter is contained in the display. The tempo setting for Arpeggio is in the COMMON display of the Arpeggio Edit.

VoiceWithARP (Voice with Arpeggio)

Each Arpeggio type is assigned a specific Voice best suited to the type. This parameter determines whether or not the appropriate Voice registered to each Arpeggio type is assigned to the edited Part. When set to “on,” the appropriate Voice is assigned to the edited Part in place of the currently assigned Voice. When set to “off,” the appropriate Voice is not assigned to the edited Part. The currently assigned Voice is maintained.

[F4] LIMIT

These are the same as in the Arpeggio Edit display (page 28) of the Voice mode.

[F5] PLAY FX (Play Effect)

These are the same as in the Arpeggio Edit display (page 28) of the Voice mode.

[F6] OUT CH (Output Channel)

OutputSwitch

When this is set to on, Arpeggio playback data is output via MIDI.

Settings: off, on

TransmitCh (Transmit Channel)

Determines the MIDI transmit channel for Arpeggio playback data. When set to “KbdCh,” the Arpeggio playback data is output via the MIDI Keyboard Transmit Channel ([UTILITY] → [F6] MIDI → [SF1] CH → “KBDTransCh”).

Settings: 1 – 16, KbdCh (Keyboard Channel)

Performance Mode

Performance Play

- [F1] PLAY
- [F2] VOICE
- [F3] PORTA
- [F4] EG
- [F5] ARP ED
- [F6] EFFECT

Arpeggio Edit

- [F1] COMMON
- ▶ [F2] TYPE
- ▶ [F3] MAIN
- ▶ [F4] LIMIT
- ▶ [F5] PLAY FX
- ▶ [F6] OUT CH

Performance Edit

Common Edit

- [F1] GENERAL
- [F2] OUT/MFX
- [F3] MEQ
- [F4] USB I/O
- [F5] A/D IN
- [F6] EFFECT

Part Edit

- [F1] VOICE
- [F2] OUTPUT
- [F3] EQ
- [F4] TONE
- [F5] RCV SW

Performance Job

- [F1] INIT
- [F2] RECALL
- [F3] COPY
- [F4] BULK

Performance Record

- [F1] SETUP
- [F2] REC TR
- [F3] OTHER
- [F5] CLICK
- [F6] INFO

Supplementary Information

Performance Edit

Each performance can contain a maximum of four Parts. There are two types of Performance Edit displays: those for Common Edit to edit the settings common to all four Parts, and those for Part Edit to edit the individual Parts. This section explains the parameters for Common Edit and Part Edit.

Common Edit

Operation

[PERFORM] → Performance selection → [EDIT] → [COMMON]

[F1] GENERAL

[SF1] NAME

From this display you can assign the category (sub and main) of the selected Performance, and create a name for the Performance. The Performance name can contain up to 20 characters. For detailed instructions on naming, see the "Basic Operation" of the Owner's Manual.

[SF2] PLY MODE (Play Mode)

SplitPoint

Determines the note number of the Split point, which divides the keyboard into two different sections.

Settings: C#-2 – G8

NOTE When the "SplitLo/Up" parameter of each Part is set to "both," this parameter will have no effect.

NOTE Sound is produced only when you play notes within the area that matches both the Split setting and Note Limit setting.

NOTE You can also set the note directly from the keyboard, by holding down the [SF6] KBD button and pressing the desired key.

SplitSwitch

Determines whether the settings of the Split Point and the Split Lower/Upper position in the Part parameter are enabled (on) or disabled (off).

Settings: off, on

[SF3] EQ OFS (EQ Offset)

This is a parametric EQ featuring three bands (High, Mid and Low). You can attenuate or boost the level of each frequency band (High, Mid, Low) to change the Voice sound. Determines the offset value for the same parameters in the [F3] EQ display ([page 67](#)).

FREQ (Frequency)

Determines the frequency for each frequency band.

GAIN

Determines the level gain for the Frequency (above), or the amount the selected frequency band is attenuated or boosted. The higher the value, the greater the Gain. The lower the value, the lesser the Gain.

Q

Determines the Q (bandwidth) for the Mid band. The higher the value, the smaller the bandwidth. The lower the value, the wider the bandwidth.

Settings: -64 – +0 – +63

[SF4] PORTA (Portamento)

This display allows you to set the Portamento-related parameters. The parameters are the same as in Performance Play. See [page 56](#).

Performance Mode

Performance Play

[F1] PLAY
[F2] VOICE
[F3] PORTA
[F4] EG
[F5] ARP ED
[F6] EFFECT

Arpeggio Edit

[F1] COMMON
[F2] TYPE
[F3] MAIN
[F4] LIMIT
[F5] PLAY FX
[F6] OUT CH

Performance Edit

Common Edit

▶ [F1] GENERAL
[F2] OUT/MFX
[F3] MEQ
[F4] USB I/O
[F5] A/D IN
[F6] EFFECT

Part Edit

[F1] VOICE
[F2] OUTPUT
[F3] EQ
[F4] TONE
[F5] RCV SW

Performance Job

[F1] INIT
[F2] RECALL
[F3] COPY
[F4] BULK

Performance Record

[F1] SETUP
[F2] REC TR
[F3] OTHER
[F5] CLICK
[F6] INFO

Supplementary Information

[SF5] OTHER**A.Func1 (Assignable Function 1 Mode)****A.Func2 (Assignable Function 2 Mode)**

Determines whether the ASSIGNABLE FUNCTION [1] and [2] buttons function as latch (hold) type or momentary type. For details on settings, see the "Synthesizer Parameter Manual" PDF document.

Settings: momentary, latch

[F2] OUT/MFX (Output/Master Effect)**[SF1] OUT (Output)****Volume**  Knob

Determines the output level of the selected Performance. You can adjust the overall volume, maintaining the balance between all Parts.

Settings: 0 – 127

Pan  Knob

Determines the stereo pan position of the selected Performance. This parameter offsets the same parameter in the Part Edit setting.

Settings: L63 (far left) – C (center) – R63 (far right)

NOTE A setting of "C" (center) maintains the individual Pan settings of each Part.

ChoSend (Chorus Send)  Knob

Determines the Send level of the signal sent from Insertion Effect A/B (or the bypassed signal) to the Chorus effect.

Settings: 0 – 127

RevSend (Reverb Send)  Knob

Determines the Send level of the signal sent from Insertion Effect A/B (or the bypassed signal) to the Reverb effect.

Settings: 0 – 127

NOTE For details about the effect connection in the Performance mode, see [page 20](#).

[SF2] MFX (Master Effect)**Switch**

Determines whether Master Effect is applied or not to the selected Performance.

Settings: off, on

Type

Determines the Master Effect type.

Settings: See the "Data List" PDF document.

NOTE The available parameters (except for the above two) differ depending on the currently selected effect type. For more details, see the "Data List" PDF document.

Preset

This lets you call up pre-programmed settings for each Effect type, designed to be used for specific applications and situations. You can change how the sound is affected by the selected pre-programmed settings.

NOTE For a list of all Preset Effect Types, see the "Data List" PDF document.

Effect Parameters

The effect parameter differs depending on the currently selected effect type. For details on the editable Effect parameters in each Effect type, see the "Data List" PDF document. Also, for details on the description for each Effect parameter, see the "Synthesizer Parameter Manual" PDF document.

Performance Mode**Performance Play**

[F1] PLAY
[F2] VOICE
[F3] PORTA
[F4] EG
[F5] ARP ED
[F6] EFFECT

Arpeggio Edit

[F1] COMMON
[F2] TYPE
[F3] MAIN
[F4] LIMIT
[F5] PLAY FX
[F6] OUT CH

Performance Edit**Common Edit**

▶ [F1] GENERAL
▶ [F2] OUT/MFX
[F3] MEQ
[F4] USB I/O
[F5] A/D IN
[F6] EFFECT

Part Edit

[F1] VOICE
[F2] OUTPUT
[F3] EQ
[F4] TONE
[F5] RCV SW

Performance Job

[F1] INIT
[F2] RECALL
[F3] COPY
[F4] BULK

Performance Record

[F1] SETUP
[F2] REC TR
[F3] OTHER
[F5] CLICK
[F6] INFO

Supplementary Information

[F3] MEQ (Master EQ)

From this display you can apply five-band equalization (LOW, LOW MID, MID, HIGH MID, HIGH) to all Parts of the selected Performance, or to all Voices.

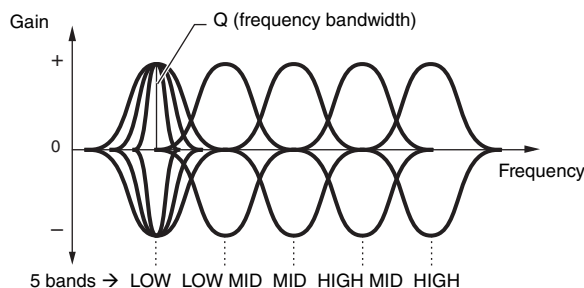

SHAPE

Determines whether the equalizer type used is Shelving or Peaking. The Peaking type attenuates/boosts the signal at the specified Frequency setting, whereas the Shelving type attenuates/boosts the signal at frequencies above or below the specified Frequency setting. This parameter is available only for the LOW and HIGH frequency bands.

Settings: shelv (Shelving type), peak (Peaking type)

shelv

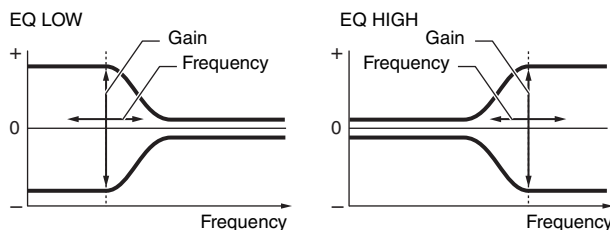

peak

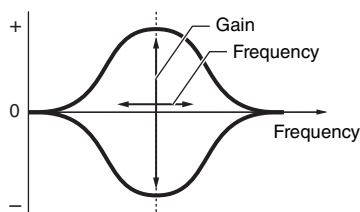

FREQ (Frequency)

Determines the center frequency. Frequencies around this point are attenuated/boosted by the Gain setting.

Settings: LOW: Shelving 32Hz – 2.0kHz, Peaking 63Hz – 2.0kHz
 LOW MID, MID, HIGH MID: 100Hz – 10.0kHz
 HIGH: 500Hz – 16.0kHz

GAIN

Determines the level gain for the Frequency (above), or the amount the selected frequency band is attenuated or boosted.

Settings: -12dB – +0dB – +12dB

Q (Frequency Characteristic)

This varies the signal level at the Frequency setting to create various frequency curve characteristics.

Settings: 0.1 – 12.0

NOTE For details on EQ structure, see the “Synthesizer Parameter Manual” PDF document.

[F4] USB I/O

USB OUTPUT SELECT

Determines whether the audio signal for each Part is output to USB 1/2 or USB 3/4. This parameter is available only when “Mode” is set to “2StereoRec” in the USB I/O display of the Utility mode.

Settings: 1&2, 3&4

Performance Mode

Performance Play

- [F1] PLAY
- [F2] VOICE
- [F3] PORTA
- [F4] EG
- [F5] ARP ED
- [F6] EFFECT

Arpeggio Edit

- [F1] COMMON
- [F2] TYPE
- [F3] MAIN
- [F4] LIMIT
- [F5] PLAY FX
- [F6] OUT CH

Performance Edit

Common Edit

- [F1] GENERAL
- [F2] OUT/MFX
- ▶ [F3] MEQ
- ▶ [F4] USB I/O
- [F5] A/D IN
- [F6] EFFECT

Part Edit

- [F1] VOICE
- [F2] OUTPUT
- [F3] EQ
- [F4] TONE
- [F5] RCV SW

Performance Job

- [F1] INIT
- [F2] RECALL
- [F3] COPY
- [F4] BULK

Performance Record

- [F1] SETUP
- [F2] REC TR
- [F3] OTHER
- [F5] CLICK
- [F6] INFO

Supplementary Information

[SF6] INFO (Information)

Indicates the setting information for direct monitor switch, the output mode for the audio signal, and other information.

[F5] A/D IN (A/D Input)

This display sets parameters related to the input from the A/D INPUT [L]/[R] jacks.

[SF1] OUTPUT

Volume

Determines the output level of the A/D input part.

Settings: 0 – 127

Pan

Determines the stereo pan position of the A/D input part.

Settings: L63 (far left) – C (center) – R63 (far right)

Chorus Send

Determines the Send level of the Audio input part signal sent to the Chorus effect. The higher the value, the more pronounced the Chorus.

Settings: 0 – 127

Reverb Send

Determines the Send level of the Audio input part signal sent to the Reverb effect. Higher values produce a more pronounced Reverb sound.

Settings: 0 – 127

Dry Level

Determines the level of the A/D input part which has not been processed with the System Effect (Chorus, Reverb).

Settings: 0 – 127

Mono/Stereo

Determines the signal configuration for the A/D input part, or how the signal or signals are routed (stereo or mono).

Settings: LMono, RMono, LRMono, stereo

LMono..... Only the L channel of the audio input is used.

RMono..... Only the R channel of the audio input is used.

LRMono..... The L and R channels of the audio input are mixed and processed in mono.

stereo..... Both the L and R channels of the audio input are used.

[SF2] CONNECT (Insertion Effect Connection)

From this display, you can set the Insertion Effect Types applied to the Audio Input signal in the Performance mode. The System Effect can be set in the EFFECT display ([page 63](#)).

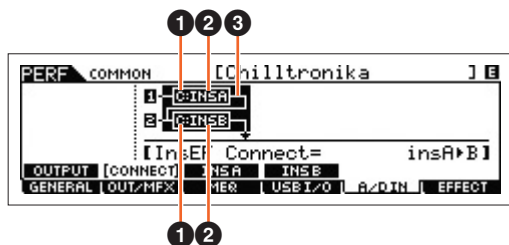

❶ Insa Ctgr (Insertion Effect A Category)/ Insb Ctgr (Insertion Effect B Category)

❷ Insa Type (Insertion Effect A Type)/ Insb Type (Insertion Effect B Type)

Determines the category and type for the Insertion Effect A/B.

Settings: For details on the editable Effect categories and types, see the “Data List” PDF document. Also, for details on the description for each Effect type, see the “Synthesizer Parameter Manual” PDF document.

Performance Mode

Performance Play

- [F1] PLAY
- [F2] VOICE
- [F3] PORTA
- [F4] EG
- [F5] ARP ED
- [F6] EFFECT

Arpeggio Edit

- [F1] COMMON
- [F2] TYPE
- [F3] MAIN
- [F4] LIMIT
- [F5] PLAY FX
- [F6] OUT CH

Performance Edit

Common Edit

- [F1] GENERAL
- [F2] OUT/MFX
- [F3] MEQ
- ▶ [F4] USB I/O
- ▶ [F5] A/D IN
- [F6] EFFECT

Part Edit

- [F1] VOICE
- [F2] OUTPUT
- [F3] EQ
- [F4] TONE
- [F5] RCV SW

Performance Job

- [F1] INIT
- [F2] RECALL
- [F3] COPY
- [F4] BULK

Performance Record

- [F1] SETUP
- [F2] REC TR
- [F3] OTHER
- [F5] CLICK
- [F6] INFO

Supplementary Information

③ InsEF Connect (Insertion Effect Connection)

Determines the effect routing for Insertion Effects A and B. The setting changes are shown on the diagram in the display, giving you a clear picture of how the signal is routed.

Settings: insA>B, insB>A

insA>B..... Signals processed with Insertion Effect A will be sent to Insertion Effect B and signals processed with Insertion Effect B are sent to Reverb and Chorus.

insB>A..... Signals processed with Insertion Effect B will be sent to Insertion Effect A and signals processed with Insertion Effect A are sent to Reverb and Chorus.

[SF3] INS A (Insertion Effect A)

[SF4] INS B (Insertion Effect B)

These displays consist of multiple pages and can be selected by pressing the Cursor [<]/[>] buttons. From these displays, you can also set each parameter of the selected Effect type individually and manually.

Category

Type

Determines the category and type for the selected effect.

Settings: For details on the editable Effect categories and types, see the "Data List" PDF document. Also, for details on the description for each Effect type, see the "Synthesizer Parameter Manual" PDF document.

Preset

This lets you call up pre-programmed settings for each Effect type, designed to be used for specific applications and situations. You can change how the sound is affected by the selected pre-programmed settings.

NOTE For a list of all Preset Effect Types, see the "Data List" PDF document.

Effect Parameters

The effect parameter differs depending on the currently selected effect type. For details on the editable Effect parameters in each Effect type, see the "Data List" PDF document. Also, for detailed descriptions for each Effect parameter, see the "Synthesizer Parameter Manual" PDF document.

[F6] EFFECT

[SF1] CONNECT

The Insertion connection type depends on the setting of the Voice assigned to the selected Part. This display sets the System Effect applied to all parts.

Chorus Ctg (Chorus Category)

Chorus Type

Reverb Type

Determines the category and type for the Chorus effect and Reverb effect.

Settings: For details on the editable Effect categories and types, see the "Data List" PDF document. Also, for detailed descriptions for each Effect type, see the "Synthesizer Parameter Manual" PDF document.

Chorus Return

Reverb Return

Determines the Return level of the Chorus/Reverb Effect.

Settings: 0 – 127

Chorus Pan

Reverb Pan

Determines the pan position of the Chorus/Reverb effect sound.

Settings: L63 (far left) – C (center) – R63 (far right)

Chorus To Reverb

Determines the Send level of the signal sent from the Chorus Effect to the Reverb Effect.

Settings: 0 – 127

Performance Mode

Performance Play

[F1] PLAY
[F2] VOICE
[F3] PORTA
[F4] EG
[F5] ARP ED
[F6] EFFECT

Arpeggio Edit

[F1] COMMON
[F2] TYPE
[F3] MAIN
[F4] LIMIT
[F5] PLAY FX
[F6] OUT CH

Performance Edit

Common Edit

[F1] GENERAL
[F2] OUT/MFX
[F3] MEQ
[F4] USB I/O
▶ [F5] A/D IN
▶ [F6] EFFECT

Part Edit

[F1] VOICE
[F2] OUTPUT
[F3] EQ
[F4] TONE
[F5] RCV SW

Performance Job

[F1] INIT
[F2] RECALL
[F3] COPY
[F4] BULK

Performance Record

[F1] SETUP
[F2] REC TR
[F3] OTHER
[F5] CLICK
[F6] INFO

Supplementary Information

[SF2] INS SW (Insertion Effect Switch)

This display lets you set to which Parts the Insertion Effects are applied.

[SF4] CHORUS

[SF5] REVERB

The number of parameters and values available differs depending on the currently selected effect type. For information on parameters, see the “Synthesizer Parameter Manual” PDF document.

Part Edit

Operation

[PERFORM] → Performance selection → [EDIT] → Part selection

[F1] VOICE

[SF1] VOICE

PartSw (Part Switch)

Determines whether each Part is on or off.

Settings: off, on

Bank

Determines the Voice Bank ([page 7](#)) for each Part.

Number

Determines the Voice Program number for each Part.

P.WithVce (Parameter with Voice)

Determines whether or not the following parameter settings of the selected Voice are copied from the Voice to the current Part when you change a Voice for the current Part individually.

- Arpeggio settings
- Filter Cutoff Frequency
- Filter Resonance
- Amplitude EG
- Filter EG
- Pitch Bend Range (Upper/Lower)
- Note Shift

NOTE Regardless of the “P.WithVce” setting, the following settings are always copied when a Normal Voice is selected: “Mono/Poly,” “Switch” (Portamento Part Switch), “Time” (Portamento Time) and “Mode” (Portamento Mode).

Settings: off (not copied), on (copied)

[SF2] MODE

Mono/Poly

Selects monophonic or polyphonic playback for each Part. Monophonic is for single notes only, and polyphonic is for playing multiple simultaneous notes.

Settings: mono, poly

NOTE This parameter is not available for the Part to which the Drum Voice is assigned.

SplitLo/Up (Split Lower/Upper)

Determines which area of the keyboard will produce the sound. When “upper” is selected, only notes at the Split Point (Common parameter) and higher will produce sound. When “lower” is selected, only notes lower than the Split Point will produce sound. When “both” is selected, all the notes across the entire keyboard will produce sound. Actually, sound is produced by playing the notes within the area that matches both the settings here and the Note Limit setting.

Settings: both, lower, upper

Performance Mode

Performance Play

- [F1] PLAY
- [F2] VOICE
- [F3] PORTA
- [F4] EG
- [F5] ARP ED
- [F6] EFFECT

Arpeggio Edit

- [F1] COMMON
- [F2] TYPE
- [F3] MAIN
- [F4] LIMIT
- [F5] PLAY FX
- [F6] OUT CH

Performance Edit

Common Edit

- [F1] GENERAL
- [F2] OUT/MFX
- [F3] MEQ
- [F4] USB I/O
- [F5] A/D IN
- ▶ [F6] EFFECT

Part Edit

- ▶ [F1] VOICE
- [F2] OUTPUT
- [F3] EQ
- [F4] TONE
- [F5] RCV SW

Performance Job

- [F1] INIT
- [F2] RECALL
- [F3] COPY
- [F4] BULK

Performance Record

- [F1] SETUP
- [F2] REC TR
- [F3] OTHER
- [F5] CLICK
- [F6] INFO

Supplementary Information

ArpPlyOnly (Arpeggio Play Only)

Determines whether or not the current Part plays only the note events of the Arpeggio playback. When this parameter is set to on, only the note events of the Arpeggio playback affect the tone generator block.

Settings: off, on

[SF3] LIMIT

NoteLimitH (Note Limit High)

NoteLimitL (Note Limit Low)

Determines the lowest and highest notes of the keyboard range for each Part. Each Part will only sound for notes played within its specified range.

Settings: C -2 – G8

NOTE If you specify the highest note first and the lowest note second, for example "C5 to C4," then the note range covered will be "C-2 to C4" and "C5 to G8."

VelLimitH (Velocity Limit High)

VelLimitL (Velocity Limit Low)

Determines the minimum and maximum values of the velocity range within which each Part will respond. Each Part will only sound for notes played within its specified velocity range.

Settings: 1 – 127

NOTE If you specify the maximum value first and the minimum value second, for example "93 to 34," then the velocity range covered will be "1 to 34" and "93 to 127."

[SF4] PORTA (Portamento)

Determines the Portamento parameters for each Part. Portamento is used to create a smooth transition in pitch from the first note played on the keyboard to the next.

Switch (Portamento Part Switch) Knob

Determines whether Portamento is applied to each Part or not.

Settings: off, on

Time (Portamento Time) Knob

Determines the pitch transition time. Higher values result in a longer pitch change time, or a slow speed.

Settings: 0 – 127

Mode (Portamento Mode)

Determines the Portamento mode.

Settings: full, fingr

full Portamento is always applied.

fingr (fingered) Portamento is only applied when you play legato (playing the next note before releasing the previous one).

NOTE These Portamento parameters above are not available for the Part to which the Drum Voice is assigned.

[SF5] VEL SENS (Velocity Sensitivity)

VelSensDpt (Velocity Sensitivity Depth)

Determines the degree to which the resulting volume of the tone generator responds to your playing strength. The higher the value, the more the volume changes in response to your playing strength (as shown below).

Settings: 0 – 127

When Offset (below) is set to 64:

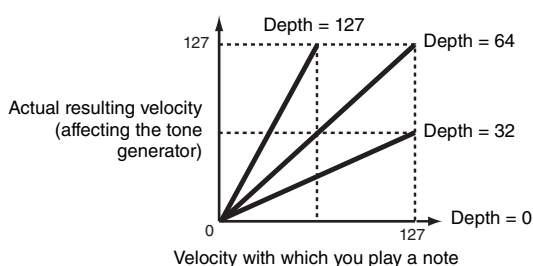

Performance Mode

Performance Play

- [F1] PLAY
- [F2] VOICE
- [F3] PORTA
- [F4] EG
- [F5] ARP ED
- [F6] EFFECT

Arpeggio Edit

- [F1] COMMON
- [F2] TYPE
- [F3] MAIN
- [F4] LIMIT
- [F5] PLAY FX
- [F6] OUT CH

Performance Edit

Common Edit

- [F1] GENERAL
- [F2] OUT/MFX
- [F3] MEQ
- [F4] USB I/O
- [F5] A/D IN
- [F6] EFFECT

Part Edit

- ▶ [F1] VOICE
- [F2] OUTPUT
- [F3] EQ
- [F4] TONE
- [F5] RCV SW

Performance Job

- [F1] INIT
- [F2] RECALL
- [F3] COPY
- [F4] BULK

Performance Record

- [F1] SETUP
- [F2] REC TR
- [F3] OTHER
- [F5] CLICK
- [F6] INFO

Supplementary Information

VelSensOfs (Velocity Sensitivity Offset)

Determines the amount by which played velocities are adjusted for the actual resulting velocity effect. This lets you raise or lower all velocities by the same amount—allowing you to automatically compensate for playing too strongly or too softly.

Settings: 0 – 127

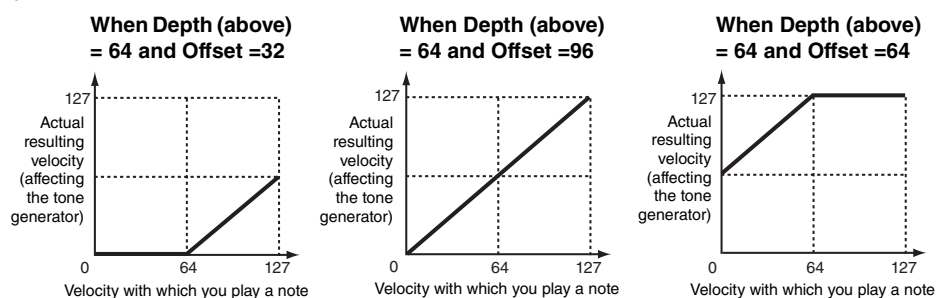

[SF6] OTHER

PB Upper (Pitch Bend Range Upper)

PB Lower (Pitch Bend Range Lower)

Determines the maximum pitch bend range for each Part in semitones. This is the same as in Voice Common Edit. See [page 31](#).

Settings: -48 semi – +0 semi – +24 semi

Assign 1 (Assign 1 Value)

Assign 2 (Assign 2 Value)

Determines the offset value by which the functions assigned to the ASSIGN 1/2 knobs will be shifted from their original settings. The ASSIGN 1/2 knobs' functions are set in the CTL SET display ([page 32](#)) of Voice Common Edit.

Settings: -64 – +0 – +63

[F2] OUTPUT

[SF1] VOL/PAN (Volume/Pan)

Volume

Determines the volume for each part, allowing you to set the optimum level balance of all the Parts.

Settings: 0 – 127

Pan

Determines the stereo pan position for each Part.

Settings: L63 (far left) – C (center) – R63 (far right)

VoiceELPan (Voice Element Pan)

Determines whether the individual pan settings for each Voice (made via [VOICE] → [EDIT] → Element selection → [F4] AMP → [SF1] LVL/PAN → Pan) are applied or not. When this is set to "off," the pan position for the each Element is set to center in the Part.

Settings: off, on

[SF2] EF SEND (Effect Send)

From this display you can set the Send Level and Dry Level sent to the System Effects for each Part. For details about the effect connection in the Performance mode, see [page 20](#).

ChoSend (Chorus Send)

Determines the volume for each Part. This lets you make detailed balance adjustments among the various sounds of the Drum Voice.

Settings: 0 – 127

Performance Mode

Performance Play

- [F1] PLAY
- [F2] VOICE
- [F3] PORTA
- [F4] EG
- [F5] ARP ED
- [F6] EFFECT

Arpeggio Edit

- [F1] COMMON
- [F2] TYPE
- [F3] MAIN
- [F4] LIMIT
- [F5] PLAY FX
- [F6] OUT CH

Performance Edit

Common Edit

- [F1] GENERAL
- [F2] OUT/MFX
- [F3] MEQ
- [F4] USB I/O
- [F5] A/D IN
- [F6] EFFECT

Part Edit

- ▶ [F1] VOICE
- ▶ [F2] OUTPUT
- [F3] EQ
- [F4] TONE
- [F5] RCV SW

Performance Job

- [F1] INIT
- [F2] RECALL
- [F3] COPY
- [F4] BULK

Performance Record

- [F1] SETUP
- [F2] REC TR
- [F3] OTHER
- [F5] CLICK
- [F6] INFO

Supplementary Information

RevSend (Reverb Send) 

Set the stereo pan position for each Part. This lets you make detailed Reverb effect adjustments among the various sounds of the Drum Voice.

Settings: 0 – 127

DryLevel

Determines the level of the unprocessed (dry) sound of the selected Part, letting you control the overall effect balance among the Parts.

Settings: 0 – 127

InsEF (Insertion Effect Part Switch)

Determines the Parts available for the Insertion Effect. When this switch is set to on, the Insertion Effect of the Voice assigned to the Part is enabled.

Settings: off, on

[F3] EQ (Equalizer)

From this display you can adjust the EQ settings for each Part. This is a parametric EQ featuring three bands (High, Mid and Low). You can attenuate or boost the level of each frequency band (High, Mid, Low) to change the Voice sound. Note that two different display types listed below are provided and you can switch between them by pressing the [SF6]. Each display type features the same settings in a different format; use the type you feel most comfortable with.

- Display showing four Parts
 - Keep in mind that since all the available parameters cannot be simultaneously displayed in the four-Part display, you will need to use the cursor controls to scroll the display in order to see and set the other parameters.
- Display showing all parameters for one Part

For details about the Effect connection including the EQ in the Performance mode, see [page 20](#).

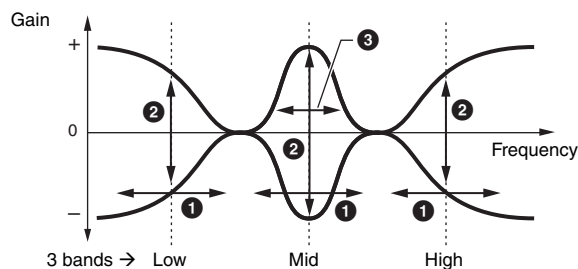
**1 FREQ (Frequency)** 

Determines the frequency for each frequency band.

Settings: Low: 50.1Hz – 2.00kHz
Mid: 139.7Hz – 10.1kHz
High: 503.8Hz – 14.0kHz

2 GAIN 

Determines the level gain for the Frequency (set above), or the amount the selected frequency band is attenuated or boosted.

Settings: -12.00dB – +0.00dB – +12.00dB

3 Q

Determines the Q (bandwidth) for the Mid band.

Settings: 0.7 – 10.3

Performance Mode**Performance Play**

- [F1] PLAY
- [F2] VOICE
- [F3] PORTA
- [F4] EG
- [F5] ARP ED
- [F6] EFFECT

Arpeggio Edit

- [F1] COMMON
- [F2] TYPE
- [F3] MAIN
- [F4] LIMIT
- [F5] PLAY FX
- [F6] OUT CH

Performance Edit**Common Edit**

- [F1] GENERAL
- [F2] OUT/MFX
- [F3] MEQ
- [F4] USB I/O
- [F5] A/D IN
- [F6] EFFECT

Part Edit

- [F1] VOICE
- [F2] OUTPUT
- [F3] EQ
- [F4] TONE
- [F5] RCV SW

Performance Job

- [F1] INIT
- [F2] RECALL
- [F3] COPY
- [F4] BULK

Performance Record

- [F1] SETUP
- [F2] REC TR
- [F3] OTHER
- [F5] CLICK
- [F6] INFO

Supplementary Information

[F4] TONE

You can set parameters related to the pitch and tone for each Part. This display sets the offset value to the same parameters in the Voice mode.

[SF1] TUNE

NoteShift

Determines the pitch (key transpose) setting for each Part in semitones.

Settings: -24 – +0 – +24

Detune

Determines the fine tuning for each Part.

Settings: -12.8Hz – +0.0Hz – +12.7Hz

[SF2] FILTER

This display sets the offset value to the filter settings in Voice Element/Key Edit of each Part.

Cutoff Knob

Determines the Cutoff Frequency for each Part. If you are using LPF (Low Pass Filter) and HPF (High Pass Filter) combined together, this parameter is available for the LPF.

Settings: -64 – +0 – +63

Resonance Knob

Determines the amount of filter resonance.

Settings: -64 – +0 – +63

FEGDepth Knob

Determines the Filter Envelope Generator depth (amount of Cutoff Frequency) for each Part. This setting is not available for the Drum Voice Parts.

Settings: -64 – +0 – +63

NOTE For details on Filter structure, see the “Synthesizer Parameter Manual” PDF document.

[SF3] FEG (Filter Envelope Generator)

From this display you can set the FEG parameters for each Part. This display sets the offset value to the FEG settings in the Voice Element Edit of each Part. These parameters are not available for the Drum Voice Parts.

Attack (Attack Time)

Decay (Decay Time)

Sustain (Sustain Level)

Release (Release Time)

Determines each parameter of the FEG for each Part. For more details about FEG, see [page 42](#).

Settings: -64 – +0 – +63

[SF4] AEG (Amplitude Envelope Generator)

From this display you can set the AEG parameters for each Part. This display sets the offset value to the filter settings in Voice Element/Key Edit of each Part.

Attack (Attack Time) Knob

Decay (Decay Time) Knob

Sustain (Sustain Level) Knob

Release (Release Time) Knob

Determines each parameter of the AEG for each Part. For more details about AEG, see [page 44](#). The “Sustain” and “Release” parameters are not available for the Drum Voice Parts.

Settings: -64 – +0 – +63

Performance Mode

Performance Play

[F1] PLAY
[F2] VOICE
[F3] PORTA
[F4] EG
[F5] ARP ED
[F6] EFFECT

Arpeggio Edit

[F1] COMMON
[F2] TYPE
[F3] MAIN
[F4] LIMIT
[F5] PLAY FX
[F6] OUT CH

Performance Edit

Common Edit

[F1] GENERAL
[F2] OUT/MFX
[F3] MEQ
[F4] USB I/O
[F5] A/D IN
[F6] EFFECT

Part Edit

[F1] VOICE
[F2] OUTPUT
[F3] EQ
▶ [F4] TONE
[F5] RCV SW

Performance Job

[F1] INIT
[F2] RECALL
[F3] COPY
[F4] BULK

Performance Record

[F1] SETUP
[F2] REC TR
[F3] OTHER
[F5] CLICK
[F6] INFO

Supplementary Information

[F5] RCV SW (Receive Switch)

From this display you can set how each individual Part responds to various MIDI data, such as Control Change and Program Change messages. When the relevant parameter is set to “on,” the corresponding Part responds to the appropriate MIDI data. Note that two different display types listed below are provided and you can switch between them by pressing the [SF6] button. Each display type features the same settings in a different format; use the type you feel most comfortable with.

- Display showing four Parts
This display type shows the Receive Switch status for four Parts at a time. Set the desired Part on or off, for the corresponding MIDI data type.
- Display showing all parameters for one Part

NOTE The “Sus” (Sustain) parameter is not available for the Drum Voice Parts.

NOTE If “Control Change” here is set to “off,” Control Change related parameters are not available.

Settings: See below.

CtrlChange (Control Change)

Indicates all Control Change messages.

PB (Pitch Bend)

MIDI messages generated by using the Pitch Bend Wheel.

MW (Modulation Wheel)

MIDI messages generated by using the Modulation Wheel.

RB (Ribbon Controller)

MIDI messages for Ribbon Controller.

ChAT (Channel After Touch)

MIDI messages for Channel After Touch.

FC1 (Foot Controller 1)

FC2 (Foot Controller 2)

MIDI messages generated by using the optional Foot Controller connected to the rear panel.

Sus (Sustain)

MIDI messages for Control Number 64 (Sustain). This parameter is not available for the Drum Voice Parts.

FS (Foot switch)

MIDI messages generated by using the optional foot switch connected to the FOOT SWITCH [ASSIGNABLE] jack on the rear panel.

AS1 (Assign 1)

AS2 (Assign 2)

MIDI messages generated by using the ASSIGN 1/ASSIGN 2 (Knob 3/Knob4) when the [TONE3] lamp is turned on by pressing Knob Function 1 button.

A.Func1 (Assignable Function 1)

A.Func2 (Assignable Function 2)

MIDI messages generated by using the ASSIGNABLE FUNCTION [1] and [2] buttons.

BC (Breath Controller)

MIDI messages for Breath Controller.

Exp (Expression)

MIDI messages for Control Number 11 (Expression).

Performance Mode

Performance Play

[F1] PLAY
[F2] VOICE
[F3] PORTA
[F4] EG
[F5] ARP ED
[F6] EFFECT

Arpeggio Edit

[F1] COMMON
[F2] TYPE
[F3] MAIN
[F4] LIMIT
[F5] PLAY FX
[F6] OUT CH

Performance Edit

Common Edit

[F1] GENERAL
[F2] OUT/MFX
[F3] MEQ
[F4] USB I/O
[F5] A/D IN
[F6] EFFECT

Part Edit

[F1] VOICE
[F2] OUTPUT
[F3] EQ
[F4] TONE
▶ [F5] RCV SW

Performance Job

[F1] INIT
[F2] RECALL
[F3] COPY
[F4] BULK

Performance Record

[F1] SETUP
[F2] REC TR
[F3] OTHER
[F5] CLICK
[F6] INFO

Supplementary Information

Performance Job

Performance Job features several basic operations, such as Initialize and Copy. After setting parameters as required in the selected display, press the [ENTER] button to execute the Job.

Operation

[PERFORM] → Performance selection → [JOB]

[F1] INIT (Initialize)

Resets (initializes) all Performance parameters to their default settings. It also allows you to selectively initialize certain parameters, such as Common settings, settings for each Part, and so on—very useful when creating a completely new Performance from scratch.

Parameter Type to be initialized

All: All data in the Performance

Common: Data in Common Edit

Part 1 – 4: Data of the Part Edit parameters of the corresponding internal Part

A/D: Data related to the A/D input part

NOTE In order to select “Common,” “Part,” or “A/D,” the “ALL” box must be unchecked.

[F2] RECALL

If you are editing a Performance and select a different Performance without storing your edited one, all the edits you've made will be erased. If this happens, you can use Edit Recall to restore the Voice with your latest edits intact.

[F3] COPY

[SF1] PART

This convenient operation lets you copy Common Edit and Part Edit settings of a certain Performance to the currently edited Performance. This is useful if you are creating a Performance and wish to use some parameter settings of another Performance.

NOTE When this display is shown, you can hear the original sound at copy source by pressing the [EDIT] to call up the Compare mode. Pressing the [EDIT] button again will exit from the Compare mode.

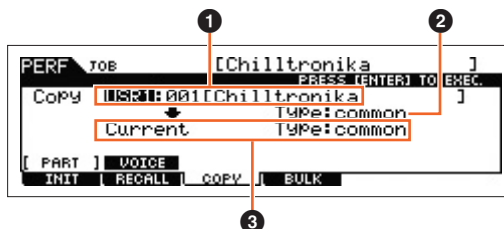

① Data type of Performance (source)

Determines the Bank and the Performance number to be copied. When “current” is selected, the current Performance is specified as the Source Performance. Accordingly, you can copy the parameter settings from a Part to a different Part of the same Performance.

Settings: Bank: USR1 – 2, ---

Performance Number: 001 (A01) – 128 (H16), Current

② Data type of the source

Determines the source data type including the Part number. According to the setting here, the Data type of the destination below will be automatically set to the appropriate item.

Settings: common, part1 – 4, A/D

③ Data type of the destination

Determines the destination data type including the Part number. According to the setting here, the Data type of the source (②) will be automatically set to the appropriate item.

Settings: common, part1 – 4, A/D

Performance Mode

Performance Play

- [F1] PLAY
- [F2] VOICE
- [F3] PORTA
- [F4] EG
- [F5] ARP ED
- [F6] EFFECT

Arpeggio Edit

- [F1] COMMON
- [F2] TYPE
- [F3] MAIN
- [F4] LIMIT
- [F5] PLAY FX
- [F6] OUT CH

Performance Edit

Common Edit

- [F1] GENERAL
- [F2] OUT/MFX
- [F3] MEQ
- [F4] USB I/O
- [F5] A/D IN
- [F6] EFFECT

Part Edit

- [F1] VOICE
- [F2] OUTPUT
- [F3] EQ
- [F4] TONE
- [F5] RCV SW

Performance Job

- ▶ [F1] INIT
- ▶ [F2] RECALL
- ▶ [F3] COPY
- [F4] BULK

Performance Record

- [F1] SETUP
- [F2] REC TR
- [F3] OTHER
- [F5] CLICK
- [F6] INFO

Supplementary Information

[SF2] VOICE

This convenient operation lets you copy Effect and Master EQ settings of a certain Voice assigned to a certain Performance to the Common parameters of the currently edited Performance. This would come in handy when a certain Performance has settings that you want to use in your Performance program.

NOTE When this display is shown, you can hear the original sound at the copy source by pressing the [EDIT] to call up the Compare mode. Pressing the [EDIT] button again will exit from the Compare mode.

❶ Source Voice

Determines the Bank and the Voice number to be copied.

Settings: Bank: PRE1 – 9, USR1 – 3, PDR, UDR, GM, GMDR
Voice Number: 001(A01) – 128 (H16)

❷ Determines which Effect units are copied

This convenient operation lets you copy Effect and Master EQ settings of a certain Voice assigned to a certain Performance to the currently edited Performance. You can select Effect units to be copied from “Rev,” “Cho,” “MEQ,” and “MFX.”

NOTE Even when each of the Reverb and Chorus is set to “on,” executing the Job does not copy the Send Level from the Voice to the Performance. If you want to apply the same depth of the Reverb and Chorus as in the Voice mode to the copied Voice, manually set the Reverb Send and Chorus Send in the OUTPUT display (page 66) of the Performance Part Edit to the same value as in Voice Edit.

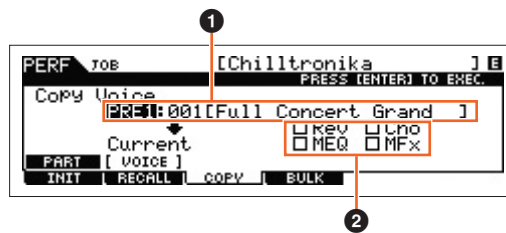

[F4] BULK (Bulk Dump)

This function lets you send all your edited parameter settings for the currently selected performance to a computer or another MIDI device for data archiving. Press the [ENTER] button to execute Bulk Dump.

NOTE In order to execute Bulk Dump, you will need to set the correct MIDI Device Number, with the following operation: [UTILITY] → [F6] MIDI → [SF1] CH → “DeviceNo.”

Performance Mode

Performance Play

- [F1] PLAY
- [F2] VOICE
- [F3] PORTA
- [F4] EG
- [F5] ARP ED
- [F6] EFFECT

Arpeggio Edit

- [F1] COMMON
- [F2] TYPE
- [F3] MAIN
- [F4] LIMIT
- [F5] PLAY FX
- [F6] OUT CH

Performance Edit

Common Edit

- [F1] GENERAL
- [F2] OUT/MFX
- [F3] MEQ
- [F4] USB I/O
- [F5] A/D IN
- [F6] EFFECT

Part Edit

- [F1] VOICE
- [F2] OUTPUT
- [F3] EQ
- [F4] TONE
- [F5] RCV SW

Performance Job

- [F1] INIT
- [F2] RECALL
- ▶ [F3] COPY
- ▶ [F4] BULK

Performance Record

- [F1] SETUP
- [F2] REC TR
- [F3] OTHER
- [F5] CLICK
- [F6] INFO

Supplementary Information

Performance Record

You can record your keyboard performance in the Performance mode to a Song or Pattern. A part of the Knob operations, the Controller operations, and Arpeggio playback as well as your keyboard playing in the Performance mode can be recorded to the specified Track as MIDI events. For information on the recorded Knob operations, see the "Sequencer Block applied to the Performance mode" (page 11).

Operation

[PERFORM] → Performance selection → [REC]

NOTICE

Performance recording overwrites all Tracks of the destination Song or Pattern Section. Please check whether or not the destination Song or Pattern Section contains data before recording. You can check whether or not each Track contains data at the Track status line on the display. Select a Song or Pattern Section containing no data as the destination or save all Song/Pattern data to an external USB flash memory device before recording.

[F1] SETUP

SeqMode (Sequencer Mode)

Determines to which destination (Song or Pattern) your Performance playing will be recorded.

Settings: song, pattern

Number (Song/Pattern Number)

Determines the Pattern or Song number as the destination for recording.

Section

Determines the Section as the destination for recording when the Sequencer Mode is set to "pattern." Keep in mind that the data recorded to the selected destination Section will be overwritten and erased as soon as recording starts.

Section Length

Specifies the length of the Section when the Sequencer Mode is set to "pattern."

Settings: 001 – 256

Time Signature (Meter)

Determines the time signature.

Settings: 1/16 – 16/16, 1/8 – 16/8, 1/4 – 8/4

Tempo

Determines the tempo for recording. While recording, the Arpeggio is played back at the tempo set here.

Settings: 5 – 300

NOTE If you are using this instrument with an external sequencer, DAW software, or MIDI device, and you want to synchronize it with that device, set the "MIDI Sync" parameter in the Utility MIDI display (page 148) to "external" or "auto." When "MIDI Sync" is set to "auto" (only when MIDI clock is transmitted continuously) or "external," the Tempo parameter here indicates "external" and cannot be changed.

NOTE This setting is copied to the tempo for the record destination (a Song/Pattern).

NOTE This parameter can be set also by holding the [SHIFT] button and pressing the [ENTER] button several times repeatedly at the desired tempo. This function is referred to as "Tap Tempo."

[SF1] ARP1 (Arpeggio 1) – [SF6] ARP6 (Arpeggio 6)

The Arpeggio types are assigned to the buttons with 8th note icons on the display tab. You can call them up by pressing these buttons any time during your keyboard performance. Selects the Arpeggio setting before recording. The Arpeggio Type can be set in the Arpeggio Edit display (page 58).

Performance Mode

Performance Play

[F1] PLAY
[F2] VOICE
[F3] PORTA
[F4] EG
[F5] ARP ED
[F6] EFFECT

Arpeggio Edit

[F1] COMMON
[F2] TYPE
[F3] MAIN
[F4] LIMIT
[F5] PLAY FX
[F6] OUT CH

Performance Edit

Common Edit

[F1] GENERAL
[F2] OUT/MFX
[F3] MEQ
[F4] USB I/O
[F5] A/D IN
[F6] EFFECT

Part Edit

[F1] VOICE
[F2] OUTPUT
[F3] EQ
[F4] TONE
[F5] RCV SW

Performance Job

[F1] INIT
[F2] RECALL
[F3] COPY
[F4] BULK

Performance Record

▶ [F1] SETUP
[F2] REC TR
[F3] OTHER
[F5] CLICK
[F6] INFO

Supplementary Information

[F2] REC TR (Record Track)

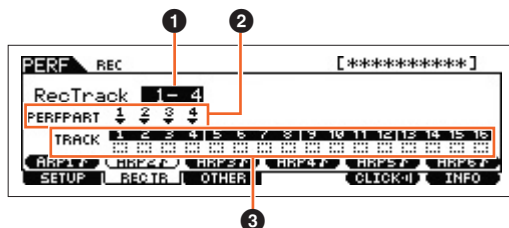

1 RecTrack (Record Track)

Determines the Tracks of the Song/Pattern as the destination for recording.

2 PERFPART (Performance Part)

Indicates the Tracks of the Song/Pattern as the destination for recording according to the "RecTrack" setting.

3 Track Status

Indicates whether each Track of the selected Song or Pattern Section contains MIDI data or not. Solid-lined squares indicate that the Track contains MIDI data, while the dotted-lined squares indicate that the Track contains no data.

[F3] OTHER

KeyOnStart (Key On Start Switch)

When set to on, recording starts immediately when you press any note on the keyboard.

Settings: off, on

CopyPerfParam (Copy Performance Parameters)

Determines whether or not the Performance parameter settings are copied to the Mixing of the destination Song or Pattern.

Settings: off, on

MoveToRecMode (Move To Record Mode)

If this is set to "on," operation moves to the destination mode for recording after Performance recording. If it is set to "off," operation moves to the Performance Play display.

Settings: off, on

[F5] CLICK

Pressing the [F5] CLICK button lets you turn the click sound (metronome) on/off for recording.

[F6] INFO (Information)

Indicates the Song/Pattern number, Section (only when the Sequencer Mode is set to "pattern"), and the Song/Pattern name which is set as the destination for the Performance recording. Also, this indicates the space left on the Sequencer memory.

Performance Mode

Performance Play

- [F1] PLAY
- [F2] VOICE
- [F3] PORTA
- [F4] EG
- [F5] ARP ED
- [F6] EFFECT

Arpeggio Edit

- [F1] COMMON
- [F2] TYPE
- [F3] MAIN
- [F4] LIMIT
- [F5] PLAY FX
- [F6] OUT CH

Performance Edit

Common Edit

- [F1] GENERAL
- [F2] OUT/MFX
- [F3] MEQ
- [F4] USB I/O
- [F5] A/D IN
- [F6] EFFECT

Part Edit

- [F1] VOICE
- [F2] OUTPUT
- [F3] EQ
- [F4] TONE
- [F5] RCV SW

Performance Job

- [F1] INIT
- [F2] RECALL
- [F3] COPY
- [F4] BULK

Performance Record

- [F1] SETUP
- ▶ [F2] REC TR
- ▶ [F3] OTHER
- ▶ [F5] CLICK
- ▶ [F6] INFO

Supplementary Information

Supplementary Information

■ Performance Category List

This is the list of the Main Categories and their Sub Categories to which the respective Performances of the MOXF6/MOXF8 belong.

Main Category (abbreviation)	Sub Category (abbreviation)												
	All	Top40	Classic Rock	Hard Rock	Country	Blues	Folk	Ballad	Film	---			
Rock/Pops	All	Top40	Classic Rock	Hard Rock	Country	Blues	Folk	Ballad	Film	---			
R&B/Hip Hop	All	Hip Hop	Modern R&B	Classic R&B	Funk	---							
Electronic	All	Techno	Trance	Dance Pop / House	Breakbeats / D&B	Chillout / Ambient	---						
Jazz	All	Swing	Modern Jazz	Smooth Jazz	Jazz Funk	Club Jazz	---						
World	All	Latin	Reggae / Dancehall	Ethnic / World	---								
Splits&Layers	All	Piano	Organ	Synth	Symphonic	Strings	Woodwind	Brass	Guitar	Bass	Chromatic Percussion	Pad	---
FX	All	Sequence	Hard	Soft	Sound Effect	---							
No Assign	---												

■ Functions of Knobs 1 – 8

This section explains the functions assigned to Knobs 1 – 8 in the Performance mode. In the Performance mode, operating Knobs 1 – 8 in Common Edit applies to the Common Edit parameters. Meanwhile, operating Knobs 1 – 8 in Part Edit applies the Part Edit parameters. For instructions, see the Owner's Manual.

When the [TONE 1] lamp is turned on:

Knob 1	CUTOFF	Common Edit	[PERFORM] → [F4] EG → FEG "CUTOFF"	page 56
		Part Edit	[PERFORM] → [EDIT] → Number [1] – [4] button → [F4] TONE → [SF2] FILTER → "Cutoff" of the selected part	page 68
Knob 2	RESONANCE	Common Edit	[PERFORM] → [F4] EG → FEG "RESO"	page 56
		Part Edit	[PERFORM] → [EDIT] → Number [1] – [4] button → [F4] TONE → [SF2] FILTER → "Resonance" of the selected part	page 68
Knob 3	FEG DEPTH	Common Edit	[PERFORM] → [F4] EG → FEG "DEPTH"	page 56
		Part Edit	[PERFORM] → [EDIT] → Number [1] – [4] button → [F4] TONE → [SF2] FILTER → "FEGDepth" of the selected part	page 68
Knob 4	PORTAMENTO	Common Edit	[PERFORM] → [F3] PORTA → "PortaTime"	page 56
		Part Edit	[PERFORM] → [EDIT] → Number [1] – [4] button → [F1] VOICE → [SF4] PORTA → "Time" of the selected part	page 65

When the [TONE 2] lamp is turned on:

Knob 1	ATTACK	Common Edit	[PERFORM] → [F4] EG → AEG "ATK"	page 56
		Part Edit	[PERFORM] → [EDIT] → Number [1] – [4] button → [F4] TONE → [SF4] AEG → "Attack" of the selected part	page 68
Knob 2	DECAY	Common Edit	[PERFORM] → [F4] EG → AEG "DCY"	page 56
		Part Edit	[PERFORM] → [EDIT] → Number [1] – [4] button → [F4] TONE → [SF4] AEG → "Decay" of the selected part	page 68
Knob 3	SUSTAIN	Common Edit	[PERFORM] → [F4] EG → AEG "SUS"	page 56
		Part Edit	[PERFORM] → [EDIT] → Number [1] – [4] button → [F4] TONE → [SF4] AEG → "Sustain" of the selected part	page 68
Knob 4	RELEASE	Common Edit	[PERFORM] → [F4] EG → AEG "REL"	page 56
		Part Edit	[PERFORM] → [EDIT] → Number [1] – [4] button → [F4] TONE → [SF4] AEG → "Release" of the selected part	page 68

Performance Mode

Performance Play

- [F1] PLAY
- [F2] VOICE
- [F3] PORTA
- [F4] EG
- [F5] ARP ED
- [F6] EFFECT

Arpeggio Edit

- [F1] COMMON
- [F2] TYPE
- [F3] MAIN
- [F4] LIMIT
- [F5] PLAY FX
- [F6] OUT CH

Performance Edit

Common Edit

- [F1] GENERAL
- [F2] OUT/MFX
- [F3] MEQ
- [F4] USB I/O
- [F5] A/D IN
- [F6] EFFECT

Part Edit

- [F1] VOICE
- [F2] OUTPUT
- [F3] EQ
- [F4] TONE
- [F5] RCV SW

Performance Job

- [F1] INIT
- [F2] RECALL
- [F3] COPY
- [F4] BULK

Performance Record

- [F1] SETUP
- [F2] REC TR
- [F3] OTHER
- [F5] CLICK
- [F6] INFO

Supplementary Information

When the [TONE 3] lamp is turned on:

Knob 1	VOLUME	Common Edit	[PERFORM] → [EDIT] → [COMMON] → [F2] OUT/MFX → [SF1] OUT → "Volume"	page 60
		Part Edit	[PERFORM] → [EDIT] → Number [1] – [4] button → [F2] OUTPUT → [SF1] VOL/PAN → "Volume" of the selected part	page 66
Knob 2	PAN	Common Edit	[PERFORM] → [EDIT] → [COMMON] → [F2] OUT/MFX → [SF1] OUT → "Pan"	page 60
		Part Edit	[PERFORM] → [EDIT] → Number [1] – [4] button → [F2] OUTPUT → [SF1] VOL/PAN → "Pan" of the selected part	page 66
Knob 3	ASSIGN 1	Common Edit	Disabled	
		Part Edit	[PERFORM] → [EDIT] → Number [1] – [4] button → [F1] VOICE → [SF6] OTHER → "Assign1" of the selected part	page 66
Knob 4	ASSIGN 2	Common Edit	Disabled	
		Part Edit	[PERFORM] → [EDIT] → Number [1] – [4] button → [F1] VOICE → [SF6] OTHER → "Assign2" of the selected part	page 66

When the [EQ] lamp is turned on:

Knob 5	LOW	Common Edit	[PERFORM] → [EDIT] → [COMMON] → [F1] GENERAL → [SF3] EQ OFS → "LOW GAIN"	page 59
		Part Edit	[PERFORM] → [EDIT] → Number [1] – [4] button → [F3] EQ → "LOW GAIN" of the selected part	page 67
Knob 6	MID F	Common Edit	[PERFORM] → [EDIT] → [COMMON] → [F1] GENERAL → [SF3] EQ OFS → "MID FREQ"	page 59
		Part Edit	[PERFORM] → [EDIT] → Number [1] – [4] button → [F3] EQ → "MID FREQ" of the selected part	page 67
Knob 7	MID	Common Edit	[PERFORM] → [EDIT] → [COMMON] → [F1] GENERAL → [SF3] EQ OFS → "MID GAIN"	page 59
		Part Edit	[PERFORM] → [EDIT] → Number [1] – [4] button → [F3] EQ → "MID GAIN" of the selected part	page 67
Knob 8	HIGH	Common Edit	[PERFORM] → [EDIT] → [COMMON] → [F1] GENERAL → [SF3] EQ OFS → "HIGH GAIN"	page 59
		Part Edit	[PERFORM] → [EDIT] → Number [1] – [4] button → [F3] EQ → "HIGH GAIN" of the selected part	page 67

When the [EFFECT] lamp is turned on:

Knob 5	CHO PRESET		[PERFORM] → [F6] EFFECT → [SF4] CHORUS → "Preset"	page 64
Knob 6	CHO SEND	Common Edit	[PERFORM] → [EDIT] → [COMMON] → [F2] OUT/MFX → [SF1] OUT → "ChoSend"	page 60
		Part Edit	[PERFORM] → [EDIT] → Number [1] – [4] button → [F2] OUTPUT → [SF2] EF SEND → "ChoSend" of the selected part	page 66
Knob 7	REV PRESET		[PERFORM] → [F6] EFFECT → [SF5] REVERB → "Preset"	page 64
Knob 8	REV SEND	Common Edit	[PERFORM] → [EDIT] → [COMMON] → [F2] OUT/MFX → [SF1] OUT → "RevSend"	page 60
		Part Edit	[PERFORM] → [EDIT] → Number [1] – [4] button → [F2] OUTPUT → [SF2] EF SEND → "RevSend" of the selected part	page 67

When the [ARP] lamp is turned on:

Knob 5	GATE TIME	Common Edit	[PERFORM] → ARP [EDIT] → [F1] COMMON → "GateTimeRate"	page 57
		Part Edit	[PERFORM] → ARP [EDIT] → [F5] PLY FX → "GateTimeRate"	page 58
Knob 6	OCT RANGE	Common Edit	Disabled	
		Part Edit	[PERFORM] → ARP [EDIT] → [F5] PLY FX → "OctaveRange"	page 58
Knob 7	UNITMULTIPLY	Common Edit	Disabled	
		Part Edit	[PERFORM] → ARP [EDIT] → [F5] PLY FX → "UnitMultiply"	page 58
Knob 8	TEMPO		[PERFORM] → ARP [EDIT] → [F1] COMMON → "Tempo"	page 57

Performance Mode

Performance Play

- [F1] PLAY
- [F2] VOICE
- [F3] PORTA
- [F4] EG
- [F5] ARP ED
- [F6] EFFECT

Arpeggio Edit

- [F1] COMMON
- [F2] TYPE
- [F3] MAIN
- [F4] LIMIT
- [F5] PLAY FX
- [F6] OUT CH

Performance Edit

Common Edit

- [F1] GENERAL
- [F2] OUT/MFX
- [F3] MEQ
- [F4] USB I/O
- [F5] A/D IN
- [F6] EFFECT

Part Edit

- [F1] VOICE
- [F2] OUTPUT
- [F3] EQ
- [F4] TONE
- [F5] RCV SW

Performance Job

- [F1] INIT
- [F2] RECALL
- [F3] COPY
- [F4] BULK

Performance Record

- [F1] SETUP
- [F2] REC TR
- [F3] OTHER
- [F5] CLICK
- [F6] INFO

Supplementary Information

Song Mode

The Song mode lets you record, edit and play your own original Songs. This section explains each parameter in four types (Song Play, Song Record, Song Edit, and Song Job).

Song Play

Song Play is the main “portal” by which you enter the Song mode, and it is here where you select and play a Song.

Operation

Press the [SONG] button.

[F1] PLAY

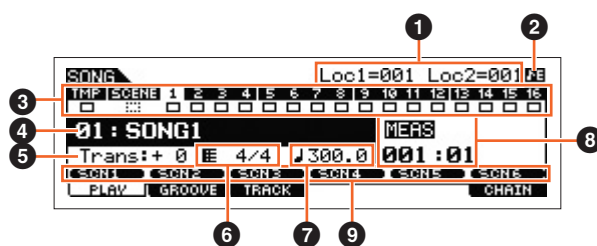

Song Play display

NOTE From the PLAY display in the Song Play mode, you can select the Voice of the Mixing Part corresponding to the current Track by pressing the [CATEGORY SEARCH] button.

1 Loc1 (Location 1), Loc2 (Location 2)

The Song Play mode has a convenient Location function that lets you jump to user-specified parts of a Song. This lets you assign a specific measure number in the selected Song, and instantly jump to the assigned measure—either during playback or when the Song is stopped. Two locations can be assigned. This display indicates the locations. For detailed instructions, see [page 97](#).

2 Sequencer Edit indicator

When changing the MIDI data and value of the parameters related sequencer (with the exception of the Mixing settings), the Sequencer Edit indicator will appear on the top right corner of the display. In Song/Pattern mode, the edit buffer for the sequencer settings is the memory location for the entire programs of both modes. Therefore, if you change the sequencer settings for one Song or one Pattern, the Sequencer Edit indicator is always shown in the Song/Pattern mode (with the exception of the Mixing mode) before storing.

NOTE Since the edit buffer for the Mixing settings is different from that for the sequencer settings, the Sequencer Edit Indicator is not shown in the Mixing mode.

3 Track Status

Indicates whether each Track contains MIDI data or not. Solid-lined squares (■) indicate that the Track contains MIDI data, while the dotted-lined squares (□) indicate that the Track contains no data.

4 Song number/ Song name

Determines the Song to be played back.

Settings: Song number 01 – 64

5 Trans (Transpose)

Determines the key transpose setting for the entire Song, and can be adjusted in semitones.

Settings: -36 – +0 – +36

6 Meter

Determines the meter (time signature) of the Song. The specified meter is applied to the measure specified in the “MEAS” (8) parameter.

Settings: 1/16 – 16/16, 1/8 – 16/8, 1/4 – 8/4

Song Mode

Song Play

- [F1] PLAY
- [F2] GROOVE
- [F3] TRACK
- [F6] CHAIN

Song Record

Song Record Standby

- [F1] SETUP
- [F2] VOICE
- [F3] ARP ED
- [F5] CLICK
- [F6] ALL TR

During Song Recording

- [F1] SETUP
- [F3] REST
- [F4] TIE
- [F5] DELETE
- [F6] BAK DEL

Arpeggio Edit

- [F1] COMMON
- [F2] TYPE
- [F3] MAIN
- [F4] LIMIT
- [F5] PLAY FX
- [F6] OUT CH

Song Edit

- [F1] CHANGE
- [F2] VIEW FLT
- [F4] TR SEL
- [F5] INSERT
- [F6] DELETE

Song Job

- [F1] UNDO/REDO
- [F2] NOTE
- [F3] EVENT
- [F4] MEAS
- [F5] TRACK
- [F6] SONG

Supplementary Information

7 **(Tempo)**

Determines the Song playback tempo.

Settings: 5.0 – 300.0

NOTE If you are using this instrument with an external sequencer, DAW software, or MIDI device, and you want to synchronize it with that device, set the “MIDI Sync” parameter in the Utility MIDI display (page 148) to “external” or “auto.” When “MIDI Sync” is set to “auto” (only when MIDI clock is transmitted continuously) or “external,” the Tempo parameter here indicates “external” and cannot be changed.

NOTE This parameter can be set also by holding the [SHIFT] button and pressing the [ENTER] button several times repeatedly at the desired tempo. This function is referred to as “Tap Tempo.”

8 **MEAS (Measure)**

Determines the location at which playback starts. This also indicates the current location of playback.

9 **SCN1 (Scene 1) – [SF6] SCN6 (Scene 6)**

You can assign the settings of the Song-related parameters (Song Scene) and the Arpeggio-related parameters to these buttons. You can also recall the settings by pressing these buttons. For detailed instructions on registering Scenes, see the “Assigning various settings related to Song playback (Song Scene)” on page 97. For detailed instructions on setting the Arpeggio-related parameters, see page 82.

NOTE Pressing the [SF1] SCN1 – [SF6] SCN6 during playback changes only the Song Scene.

NOTE After registering the Song Scene, the 8th note icon will appear on the tab corresponding to the pressed button. You can confirm whether the Arpeggio Type is assigned to that button in the Arpeggio Edit display (page 82) of the Song mode.

[F2] GROOVE (Grid Groove)

The Grid Groove function makes it possible to adjust the pitch, timing, length, and velocity of notes in a specified Track via a 1-measure 16th-note grid to create “grooves” with precise sequencer-like programming, which would not otherwise be possible. The Grid Groove function affects Song playback without actually changing the sequence data.

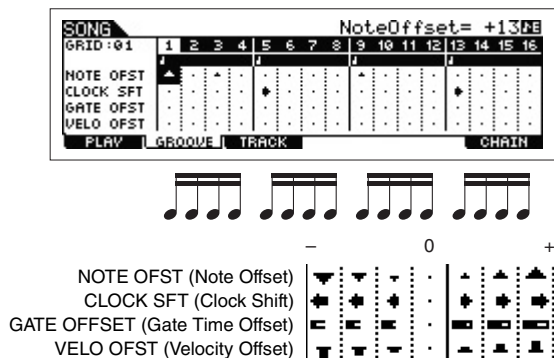

NOTE OFST (Note Offset)

Raises or lowers the pitch of the note(s) on the selected grid in semitones.

Settings: -99 – +00 – +99

CLOCK SFT (Clock Shift)

Shifts the timing of the note(s) on the selected grid forward or backward in clock increments.

Settings: -120 – +000 – +120

GATE OFFSET (Gate Time Offset)

Lengthens or shortens the note(s) on the selected grid in clock increments.

Settings: -120 – +000 – +120

VELO OFST (Velocity Offset)

Increases or decreases the velocity of the note(s) on the selected grid.

Settings: -127 – +000 – +127

Song Mode

Song Play

- ▶ [F1] PLAY
- ▶ [F2] GROOVE
- [F3] TRACK
- [F6] CHAIN

Song Record

Song Record Standby

- [F1] SETUP
- [F2] VOICE
- [F3] ARP ED
- [F5] CLICK
- [F6] ALL TR

During Song Recording

- [F1] SETUP
- [F3] REST
- [F4] TIE
- [F5] DELETE
- [F6] BAK DEL

Arpeggio Edit

- [F1] COMMON
- [F2] TYPE
- [F3] MAIN
- [F4] LIMIT
- [F5] PLAY FX
- [F6] OUT CH

Song Edit

- [F1] CHANGE
- [F2] VIEW FLT
- [F4] TR SEL
- [F5] INSERT
- [F6] DELETE

Song Job

- [F1] UNDO/REDO
- [F2] NOTE
- [F3] EVENT
- [F4] MEAS
- [F5] TRACK
- [F6] SONG

Supplementary Information

[F3] TRACK

[SF1] CHANNEL

From this display you can set the MIDI output channel for each of the sixteen Tracks of the corresponding internal/external tone generator. You can also simultaneously set multiple Tracks (Tracks 1 – 8 or Tracks 9 – 16) to the same value as the currently selected Track, by changing the parameter while holding the [SF4] 1 – 8 button or [SF5] 9 – 16 button.

OUT CH (Output Channel)

Determines the MIDI transmit channel of the sequence data for each Track. Tracks set to “Off” will not sound.

Settings: 1 – 16, off

NOTE In the Song/Pattern mode, MIDI messages created by playing the keyboard/knobs/wheels is sent to the tone generator block or the external MIDI instruments via the MIDI output channel of the currently selected Track.

[SF2] OUT SW (Output Switch)

You can also simultaneously set multiple Tracks (Tracks 1 – 8 or Tracks 9 – 16) to the same value as the currently selected Track, by changing the parameter while holding the [SF4] 1 – 8 button or [SF5] 9 – 16 button.

INT SW (Internal Switch)

Determines whether playback data is transmitted to the internal tone generator block or not.

Settings: off, on

EXT SW (External Switch)

Determines whether playback data is output to the external MIDI tone generator via MIDI or not.

Settings: off, on

[SF3] TR LOOP (Track Loop)

From this display you can determine whether the data in the selected Track loops or not in playback. Using Loop can be an effective way to repeat short patterns and phrases throughout the Song. For details, see [page 99](#).

Settings: off, on

[F6] CHAIN

This function allows Songs to be “chained” together for automatic sequential playback. For details, see [page 98](#).

skip..... Skips past (ignores) the selected chain number and continues playback from the next chain number.

stop Stops Song chain playback at the selected chain number. You can restart the Song chain playback from the next chain number by pressing the [▶] (Play) button.

end Indicates the end mark of the Song chain data.

Song Mode

Song Play

- [F1] PLAY
- [F2] GROOVE
- ▶ [F3] TRACK
- ▶ [F6] CHAIN

Song Record

Song Record Standby

- [F1] SETUP
- [F2] VOICE
- [F3] ARP ED
- [F5] CLICK
- [F6] ALL TR

During Song Recording

- [F1] SETUP
- [F3] REST
- [F4] TIE
- [F5] DELETE
- [F6] BAK DEL

Arpeggio Edit

- [F1] COMMON
- [F2] TYPE
- [F3] MAIN
- [F4] LIMIT
- [F5] PLAY FX
- [F6] OUT CH

Song Edit

- [F1] CHANGE
- [F2] VIEW FLT
- [F4] TR SEL
- [F5] INSERT
- [F6] DELETE

Song Job

- [F1] UNDO/REDO
- [F2] NOTE
- [F3] EVENT
- [F4] MEAS
- [F5] TRACK
- [F6] SONG

Supplementary Information

Song Recording

Song Record Standby mode

Operation

[SONG] → Song selection → [REC]

[F1] SETUP

Type

Determines the Recording Type. The Recording Type can be divided into two groups: Realtime recording and Step recording. With Realtime recording, the instrument functions in the same way as a tape recorder, recording the performance data as it is played. This allows you to capture all the nuances of an actual performance. In Realtime recording, the "Type" should be set to "replace," "overdub," or "punch." With Step recording, you can compose your performance by "writing" it down one event at a time. This is a non-realtime, step recording method—similar to writing music notation onto paper. In Step recording, the "Type" should be set to "step."

Settings: When the RecTr is set to any of 1-16: replace, overdub, punch, step

When the RecTr is set to tempo: replace, punch, step

When the RecTr is set to scene: replace, punch

When the RecTr is set to all: replace, overdub, punch

replace You can use this method when you want to overwrite an already recorded Track with new data in real time. The original data will be erased.

overdub You can use this method when you want to add more data to a Track that already contains data. Previously recorded data will be maintained.

punch You can use this method when you want to overwrite data to a specified range of a Track that already contains data. It allows you to overwrite the already recorded data from the starting point to the ending point (measure/beat) that was specified before recording.

step..... Use this method to enter notes manually one at a time.

NOTE When "punch" is selected, "Punch-in measure: beat" and "Punch-out measure : beat" appear in the display and should be set. If you've set the Locate 1 and 2 points (Loc1, Loc2), the punch-in/out points can be set with a single button press. Move the cursor to the punch-in/out value, and notice that a "COPYLOC" menu item appears. Press the [SF1] COPYLOC button, and the punch-in/out settings are automatically assigned to the existing Locate points.

Quantize (Resolution)

This parameter is available when the Recording Type is set to something other than "step." Record quantize aligns the timing of notes automatically, as you record. You can set this parameter also by using the Note Type selection window called up via the [SF6] button.

Settings: off, 60 (32nd note), 80 (16th note triplet), 120 (16th note), 160 (8th note triplet), 240 (8th note), 320 (1/4 note triplet), 480 (1/4 note)

Event

This parameter is available when the Recording Type is set to "step." This lets you specify the event type to be entered.

Settings: note, p.bend (pitch bend), CC#000 – #119 (Control Change)

RecTr (Recording Track)

Determines the Track to be recorded. Pressing the [F6] button lets you switch between Single Track recording and All Track recording.

Settings: tempo, scene, 1 – 16, all

Ch (Channel)

Determines the MIDI Recording Channel.

Settings: 1 – 16, all

(Tempo) Knob

Determines the Song tempo.

Settings: 005.0 – 300.0

NOTE If you are using this instrument with an external sequencer, DAW software, or MIDI device, and you want to synchronize it with that device, set the "MIDI Sync" parameter in the Utility MIDI display (page 148) to "external" or "auto." When "MIDI Sync" is set to "auto" (only when MIDI clock is transmitted continuously) or "external," the Tempo parameter here indicates "external" and cannot be changed.

NOTE This parameter can be set also by holding the [SHIFT] button and pressing the [ENTER] button several times repeatedly at the desired tempo. This function is referred to as "Tap Tempo."

Song Mode

Song Play

[F1] PLAY
[F2] GROOVE
[F3] TRACK
[F6] CHAIN

Song Record

Song Record Standby

▶ [F1] SETUP
[F2] VOICE
[F3] ARP ED
[F5] CLICK
[F6] ALL TR

During Song Recording

[F1] SETUP
[F3] REST
[F4] TIE
[F5] DELETE
[F6] BAK DEL

Arpeggio Edit

[F1] COMMON
[F2] TYPE
[F3] MAIN
[F4] LIMIT
[F5] PLAY FX
[F6] OUT CH

Song Edit

[F1] CHANGE
[F2] VIEW FLT
[F4] TR SEL
[F5] INSERT
[F6] DELETE

Song Job

[F1] UNDO/REDO
[F2] NOTE
[F3] EVENT
[F4] MEAS
[F5] TRACK
[F6] SONG

Supplementary Information

Meas (Measure)

Determines the measure from which Song recording will be started. You can set this parameter also by using the window for inputting a number directly called up via the [SF6] NUM button.

[F2] VOICE

In this display you can set the Voice-related parameters for the recording Track. The settings here affect the Part for which the receive channel (set in the Mixing mode) matches the transmit (output) channel of the recording Track.

Voice

Determines the voice used in the recording Track. When the cursor is located here, you can select a voice by using the bank, group, number buttons and the Category Search function.

Volume  Knob

Determines the volume of the recording Track.

Settings: 0 – 127

Pan  Knob

Determines the stereo pan position of the recording Track.

Settings: L63 (far left) – C (center) – R63 (far right)

InsEF (Insertion Effect Part Switch)

Determines whether the Insertion effects are applied to the recording Track or not.

Settings: off, on

♩ (Tempo)  Knob

Determines the Song tempo. This parameter is same as the tempo setting in the [F1] SETUP display.

Settings: 005.0 – 300.0

NOTE This parameter can be set also by holding the [SHIFT] button and pressing the [ENTER] button several times repeatedly at the desired tempo. This function is referred to as "Tap Tempo."

Meas (Measure)

Determines the measure from which Song recording will be started.

[F3] ARP ED (Arpeggio Edit)

Indicates the Arpeggio Edit display ([page 82](#)) of the Song mode.

[F5] CLICK

Pressing the [F5] CLICK button lets you turn the click sound (metronome) on/off for recording.

NOTE In the CLICK display ([page 144](#)), you can make various settings for the metronome click, such as the note resolution, volume, and lead-in count for recording.

[F6] ALL TR (All Track)

Pressing the [F6] lets you switch between Single Track recording and All Track recording.

Song Mode**Song Play**

[F1] PLAY
[F2] GROOVE
[F3] TRACK
[F6] CHAIN

Song Record**Song Record Standby**

▶ [F1] SETUP
▶ [F2] VOICE
▶ [F3] ARP ED
▶ [F5] CLICK
▶ [F6] ALL TR

During Song Recording

[F1] SETUP
[F3] REST
[F4] TIE
[F5] DELETE
[F6] BAK DEL

Arpeggio Edit

[F1] COMMON
[F2] TYPE
[F3] MAIN
[F4] LIMIT
[F5] PLAY FX
[F6] OUT CH

Song Edit

[F1] CHANGE
[F2] VIEW FLT
[F4] TR SEL
[F5] INSERT
[F6] DELETE

Song Job

[F1] UNDO/REDO
[F2] NOTE
[F3] EVENT
[F4] MEAS
[F5] TRACK
[F6] SONG

Supplementary Information

During Song Recording

Operation [SONG] → Song selection → [REC] → [▶] (Play)

In Realtime recording, the editable parameters during recording are in the [F1] SETUP display, [F2] VOICE display, and [F3] ARP ED display of the Song recording standby mode. In Step recording, the displays shown during recording are different from the Song recording standby mode. The following parameters can be edited during recording.

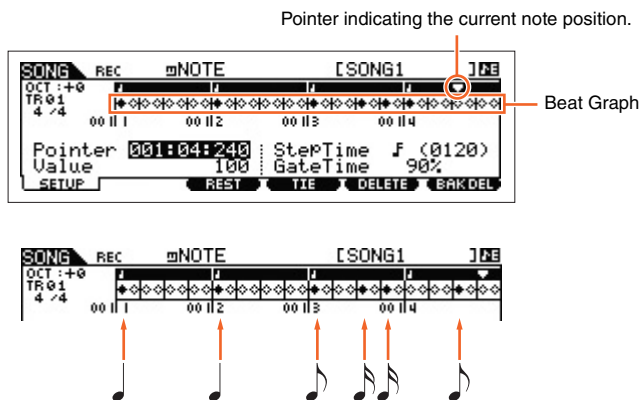

[F1] SETUP

This is the display in which notes are “placed” during step recording. When the meter is 4/4, the display is divided into four beats (one measure). Each diamond-shaped marker in the display represents one 32nd beat (each 1/4 note division is divided into eight 32nd beats). For example, if the following rhythmic pattern “♪♪♪♪♪♪♪♪” is entered in 4/4 time, a display like the one shown above right will appear.

Pointer

Determines the data-entry position. The triangular pointer above the beat graph indicates the data-entry position. To move the pointer right or left, use the [INC] and [DEC] buttons or the [DATA] dial.

Value

When the Event to be entered ([F1] SETUP → Event) is set to “note,” this value specifies the velocity with which the note will be entered.

- Settings:** When the Event is set to “note”: 1-127, kbd, rnd1 – rnd4 1 – 127, kbd, rnd1 – rnd4
 When the Event is set to “p.bend”: -8192 – +8191
 When the Event is set to “CC (Control Change 001 – 119)”: 000 – 127
 When the Event is set to “tempo” with RecTr = tempo: 005 – 300

NOTE You can select “kbd” (keyboard) and “rnd1” – “rnd4” (random1 – 4) as well as the values 1 – 127 when the Event to be entered is set to “note.” When “kbd” is selected, the actual playing strength will be entered as the velocity value. When one of the random settings is selected, a random velocity value will be entered.

StepTime

This indicates the “size” of the current recording step time for the next note to be entered, and determines to what position the pointer will advance after a note has been entered. You can set this parameter also by using the Note Type selection window called up via the [SF6] button.

- Settings:** 0001 – 0059, 32nd note, 16th note triplet, 16th note, 8th note triplet, 8th note, 1/4 note triplet, 1/4 note, half note, whole note

GateTime

“Gate time” refers to the actual length of time the note sounds. For the same quarter note, for example, a long gate time will produce a slur while a short gate time will produce a staccato effect. This allows you to produce slurs, staccato notes, etc. Gate time is indicated as a percent value of the step time.

- Settings:** 1% – 200%

Song Mode

Song Play

- [F1] PLAY
- [F2] GROOVE
- [F3] TRACK
- [F6] CHAIN

Song Record

Song Record Standby

- [F1] SETUP
- [F2] VOICE
- [F3] ARP ED
- [F5] CLICK
- [F6] ALL TR

During Song Recording

- [F1] SETUP
- [F3] REST
- [F4] TIE
- [F5] DELETE
- [F6] BAK DEL

Arpeggio Edit

- [F1] COMMON
- [F2] TYPE
- [F3] MAIN
- [F4] LIMIT
- [F5] PLAY FX
- [F6] OUT CH

Song Edit

- [F1] CHANGE
- [F2] VIEW FLT
- [F4] TR SEL
- [F5] INSERT
- [F6] DELETE

Song Job

- [F1] UNDO/REDO
- [F2] NOTE
- [F3] EVENT
- [F4] MEAS
- [F5] TRACK
- [F6] SONG

Supplementary Information

[F3] REST

Press [F3] to enter a rest as long as the specified step time. The point will move ahead to the next data-entry position. Rests do not appear on the display.

NOTE There is no actual data representing rests in the MIDI sequencer. When a "rest" is entered the pointer simply moves ahead to the next data-entry position, effectively leaving a rest.

[F4] TIE

When the [F4] button is pressed to enter a tie, the preceding note is lengthened to the full step time. For example, in the phrase above, notes are entered with 1/4 note step time. If the step time is then changed to an 8th note and [F4] is pressed, a note is entered. Dotted notes can also be entered using the TIE function. To produce a dotted 1/4 note, for example, set the step time to an 8th note, enter a note and then press [F4] twice.

NOTE This display is available only when the Event to be entered is set to "note."

[F5] DELETE

Press this to actually delete the note events at the current cursor position.

[F6] BAK DEL (Back Delete)

Moves the pointer backward by one step and deletes all notes at that location.

NOTE Mistakenly entered notes can be erased by pressing [F6] immediately after they are entered (before changing the step time value).

Arpeggio Edit

This display contains the basic settings for Arpeggio playback, including Type and Tempo. The MOXF6/MOXF8 has four arpeggiators. In the Song mode, the different Arpeggio types can be assigned to up to four parts, and up to four arpeggio types can be simultaneously played. The parameters are the same as in the Voice mode (page 27) except for the following.

Operation

[SONG] → [REC] → [F3] ARP ED
Song mode → ARP [EDIT]

[F1] COMMON**Switch**

Determines whether Arpeggio is on or off for all Parts. This setting is applied to the ARP [ON/OFF] button on the panel.

Settings: off, on

SyncQtzValue (Sync Quantize Value)

Determines the actual timing at which the next Arpeggio playback starts when you trigger it while the Arpeggio of a certain Part is played back. When set to "off," the next Arpeggio starts as soon as you trigger it. The number shown at right of each value indicates the resolution of the 1/4 note in clocks.

Settings: off, 60 (32nd note), 80 (16th note triplet), 120 (16th note), 160 (8th note triplet), 240 (8th note), 320 (1/4 note triplet), 480 (1/4 note)

Song Mode**Song Play**

- [F1] PLAY
- [F2] GROOVE
- [F3] TRACK
- [F6] CHAIN

Song Record**Song Record Standby**

- [F1] SETUP
- [F2] VOICE
- [F3] ARP ED
- [F5] CLICK
- [F6] ALL TR

During Song Recording

- [F1] SETUP
- ▶ [F3] REST
- ▶ [F4] TIE
- ▶ [F5] DELETE
- ▶ [F6] BAK DEL

Arpeggio Edit

- ▶ [F1] COMMON
- [F2] TYPE
- [F3] MAIN
- [F4] LIMIT
- [F5] PLAY FX
- [F6] OUT CH

Song Edit

- [F1] CHANGE
- [F2] VIEW FLT
- [F4] TR SEL
- [F5] INSERT
- [F6] DELETE

Song Job

- [F1] UNDO/REDO
- [F2] NOTE
- [F3] EVENT
- [F4] MEAS
- [F5] TRACK
- [F6] SONG

Supplementary Information

QtzStrength (Quantize Strength)

Determines the offset value for “QtzStrength” in the [F5] PLAY FX display. This parameter is applied to all parts.

Settings: -100 – +0 – +100

VelocityRate

Determines the offset value for “VelocityRate” in the [F5] PLAY FX display. This parameter is applied to all parts.

Settings: -100 – +0 – +100

GateTimeRate

Determines the offset value for “GateTimeRate” in the [F5] PLAY FX display. This parameter is applied to all parts.

Settings: -100 – +0 – +100

Swing

Determines the offset value for “Swing” in the [F5] PLAY FX display. This parameter is applied to all parts.

Settings: -120 – +0 – +120

[F2] TYPE

These are the same as in the Arpeggio Edit display (page 27) of the Voice mode.

[F3] MAIN

These are the same as in the Arpeggio Edit display (page 27) of the Voice mode. Please note that the “Tempo” parameter is not in the MAIN display of the Song mode. Instead, the following parameter is available in the display. The tempo setting for arpeggio is same as the tempo setting in the Song Play display.

VoiceWithARP (Voice with Arpeggio)

Each Arpeggio type is assigned a specific Voice best suited to the type. This parameter determines whether or not the appropriate Voice registered to each Arpeggio type is assigned to the edited Part. When set to “on,” the appropriate Voice is assigned to the edited Part in place of the currently assigned Voice. When set to “off,” the appropriate Voice is not assigned to the edited Part. The currently assigned Voice is maintained.

[F4] LIMIT

These are the same as in the Arpeggio Edit display (page 28) of the Voice mode.

[F5] PLAY FX (Play Effect)

These are the same as in the Arpeggio Edit display (page 28) of the Voice mode.

[F6] OUT CH (Output Channel)**OutputSwitch**

When this is set to on, Arpeggio playback data is output via MIDI.

Settings: off, on

TransmitCh (Transmit Channel)

Determines the MIDI transmit channel for Arpeggio playback data. When set to “KbdCh,” the Arpeggio playback data is output via the MIDI Keyboard Transmit Channel ([UTILITY] → [F6] MIDI → “KBDTransCh”).

Settings: 1 – 16, KbdCh (Keyboard Channel)

Song Mode**Song Play**

- [F1] PLAY
- [F2] GROOVE
- [F3] TRACK
- [F6] CHAIN

Song Record**Song Record Standby**

- [F1] SETUP
- [F2] VOICE
- [F3] ARP ED
- [F5] CLICK
- [F6] ALL TR

During Song Recording

- [F1] SETUP
- [F3] REST
- [F4] TIE
- [F5] DELETE
- [F6] BAK DEL

Arpeggio Edit

- ▶ [F1] COMMON
- ▶ [F2] TYPE
- ▶ [F3] MAIN
- ▶ [F4] LIMIT
- ▶ [F5] PLAY FX
- ▶ [F6] OUT CH

Song Edit

- [F1] CHANGE
- [F2] VIEW FLT
- [F4] TR SEL
- [F5] INSERT
- [F6] DELETE

Song Job

- [F1] UNDO/REDO
- [F2] NOTE
- [F3] EVENT
- [F4] MEAS
- [F5] TRACK
- [F6] SONG

Supplementary Information

Song Edit

This mode gives you comprehensive, detailed controls for editing the MIDI events of individual Song Tracks. MIDI events are messages (such as note on/off, note number, program change number, etc.) that make up the data of a recorded Track. It can be used to correct mistakes as well as add dynamics or effects such as vibrato to refine and finish the Song.

Operation

[SONG] → Song selection → [EDIT]

[F1] CHANGE

Shows the Event List of the selected Song Track. See the Owner's Manual for instructions.

[F2] VIEW FLT (View Filter)

The display lets you select the event types that appear on the CHANGE display. For example, if you wish to edit only note events, place a checkmark in the box next to "Note" so that only the note events appear in the CHANGE display (Event List).

Settings: Note, PitchBend, ProgramChange, ControlChange, Ch.AfterTouch, PolyAfterTouch, RPN (Registered Parameter Number), NRPN (Non Registered Parameter Number), Exclusive

[F5] CLR ALL (Clear All)

Press the [F5] to remove all checkmarks at once.

[F6] SET ALL

Press the [F6] to set checkmarks into all boxes.

[F4] TR SEL (Track Select)

You can switch between the display for 1 – 16 Tracks, SCN (Scene) Track, and TMP (Tempo) Track by pressing this button.

[F5] INSERT

When the cursor is located at the desired position in the [F1] CHANGE display (Event List), pressing this button calls up the display for inserting new MIDI events in the Song mode or Pattern mode. The event types which can be inserted to the Song are described below.

Note

These are the events that define notes, making up the largest portion of all performance data. This is the most common and prevalent type of data.

NOTE (Note name)

Determines the note name or the specific keyboard pitch of the note.

Settings: C -2 – G8

GATE (Gate time)

Determines the length of time that a note actually sounds in beats and clocks.

Settings: 000:001 – 999:479

NOTE On this synthesizer, one clock is 1/480th of a quarter note.

VELO (Velocity)

Determines how strongly the selected note sounds.

Settings: 001 – 127

Song Mode

Song Play

- [F1] PLAY
- [F2] GROOVE
- [F3] TRACK
- [F6] CHAIN

Song Record

Song Record Standby

- [F1] SETUP
- [F2] VOICE
- [F3] ARP ED
- [F5] CLICK
- [F6] ALL TR

During Song Recording

- [F1] SETUP
- [F3] REST
- [F4] TIE
- [F5] DELETE
- [F6] BAK DEL

Arpeggio Edit

- [F1] COMMON
- [F2] TYPE
- [F3] MAIN
- [F4] LIMIT
- [F5] PLAY FX
- [F6] OUT CH

Song Edit

- ▶ [F1] CHANGE
- ▶ [F2] VIEW FLT
- ▶ [F4] TR SEL
- ▶ [F5] INSERT
- [F6] DELETE

Song Job

- [F1] UNDO/REDO
- [F2] NOTE
- [F3] EVENT
- [F4] MEAS
- [F5] TRACK
- [F6] SONG

Supplementary Information

PitchBend

These are the events that define continuous changes in pitch and they are generated by Pitch Bend Wheel operation.

DATA

Determines the Pitch Bend data.

Settings: -8192 – +8191

ProgramChange

Program change events are used to select Voices.

BANK

Determines the Voice bank. The voice bank consists of MSB and LSB.

Settings: 000 – 127, ***

NOTE Bank select MSB and LSB are actually part of the Control Change set of messages (below). However, since they apply specifically to Voice selection, they are grouped and described here.

PC NO (Program Change Number)

Determines the specific Voice (from the bank selected by MSB and LSB above).

Settings: 000 – 127

NOTE For information on the Voice Bank and Voice number, see the "Voice List" in the "Data List" PDF document.

Control Change

These events control the sound and certain response characteristics of the voice, and are usually generated/recorded by moving a controller (such as a modulation wheel, knob, slider or foot controller).

CTRL NO (Control Number)

Determines the Control Change number.

Settings: 000 – 127

NOTE For information on the functions assigned to the each Control Change number, see the "MIDI" section of the "Synthesizer Parameter Manual" PDF document.

DATA

See "Data Entry MSB/LSB" in the "MIDI" section of the "Synthesizer Parameter Manual" PDF document.

Settings: 000 – 127

Ch.AfterTouch (Channel After Touch)

This event is generated when pressure is applied to a key after the note is played.

NOTE The keyboard of the MOXF6/MOXF8 does not feature an After Touch function. However, you can insert After Touch events into the Song data from this display.

DATA

This represents the amount of pressure applied to the key.

Settings: 000 – 127

PolyAfterTouch (Polyphonic After Touch)

This event is generated when pressure is applied to a key after the note is played. Unlike the Channel After Touch event, however, individual data is provided for each key.

NOTE The keyboard of the MOXF6/MOXF8 does not feature an After Touch function. However, you can insert After Touch events into the Song data from this display.

NOTE

Determines the key to which After Touch is applied.

Settings: C -2 – G8

DATA

This represents the amount of pressure applied to the key.

Settings: 000 – 127

Song Mode

Song Play

- [F1] PLAY
- [F2] GROOVE
- [F3] TRACK
- [F6] CHAIN

Song Record

Song Record Standby

- [F1] SETUP
- [F2] VOICE
- [F3] ARP ED
- [F5] CLICK
- [F6] ALL TR

During Song Recording

- [F1] SETUP
- [F3] REST
- [F4] TIE
- [F5] DELETE
- [F6] BAK DEL

Arpeggio Edit

- [F1] COMMON
- [F2] TYPE
- [F3] MAIN
- [F4] LIMIT
- [F5] PLAY FX
- [F6] OUT CH

Song Edit

- [F1] CHANGE
- [F2] VIEW FLT
- [F4] TR SEL
- ▶ [F5] INSERT
- [F6] DELETE

Song Job

- [F1] UNDO/REDO
- [F2] NOTE
- [F3] EVENT
- [F4] MEAS
- [F5] TRACK
- [F6] SONG

Supplementary Information

RPN (Registered Parameter Number)

These events are used to change the parameter values for each tone generator Part. This event is used to set part settings such as Pitch Bend Sensitivity or Tuning.

MSB-LSB

See “Registered Parameter Number MSB/LSB” in the “MIDI” section of the “Synthesizer Parameter Manual” PDF document.

Settings: 000 – 127

DATA (Data Entry MSB-LSB)

See “Registered Parameter Number MSB/LSB” in the “MIDI” section of the “Synthesizer Parameter Manual” PDF document.

Settings: 000 – 127, ***

NOTE Normally three types of control change data are sent: RPN MSB (101), RPN LSB (100), and Data Entry MSB (6). In this synthesizer, Data Entry LSB (38) is added to this and the resulting group of control change events is handled as one in this display. Note that once the RPN has been set for a channel, subsequent data entry will be recognized as the same RPN's value change. When performing a control operation, you should transmit an RPN Null message (7FH, 7FH) after using these messages to prevent operational errors.

NRPN (Non Registered Parameter Number)

Changes parameter values for each tone generator part. They can be used to edit sounds via MIDI, allowing you to edit filter or EG settings, or adjust the pitch or level for each instrument of a drum voice.

MSB-LSB

See “Non Registered Parameter Number MSB/LSB” in the “MIDI” section of the “Synthesizer Parameter Manual” PDF document.

Settings: 000 – 127

DATA (Data Entry MSB-LSB)

See the “Non Registered Parameter Number MSB/LSB” in the “MIDI” section of the “Synthesizer Parameter Manual” PDF document.

Settings: 000 – 127, ***

NOTE Normally three types of control change data are sent: NRPN MSB (99), NRPN LSB (98), and Data Entry MSB (6). In this synthesizer, Data Entry LSB (38) is added to this and the resulting group of control change events is handled as one in this display. Note that once the NRPN has been set for a channel, subsequent data entry will be recognized as the same NRPN's value change. When performing a control operation, you should transmit an RPN Null message (7FH, 7FH) after using these messages to prevent operational errors.

NOTE The MOXF6/MOXF8 cannot receive NRPN messages.

Exclusive (System Exclusive)

A type of MIDI message used to exchange data unique to a specific model or type of device. Unlike other MIDI events, these events differ depending on the manufacturer/device, and are incompatible among different devices.

DATA (HEX)

See the System Exclusive message in the “MIDI” section of the “Synthesizer Parameter Manual” PDF document.

Settings: 00 – 7F, F7 (Data must be entered in hexadecimal format.)

[F6] DELETE

Press this to actually delete the note events at the current cursor position.

Song Mode

Song Play

- [F1] PLAY
- [F2] GROOVE
- [F3] TRACK
- [F6] CHAIN

Song Record

Song Record Standby

- [F1] SETUP
- [F2] VOICE
- [F3] ARP ED
- [F5] CLICK
- [F6] ALL TR

During Song Recording

- [F1] SETUP
- [F3] REST
- [F4] TIE
- [F5] DELETE
- [F6] BAK DEL

Arpeggio Edit

- [F1] COMMON
- [F2] TYPE
- [F3] MAIN
- [F4] LIMIT
- [F5] PLAY FX
- [F6] OUT CH

Song Edit

- [F1] CHANGE
- [F2] VIEW FLT
- [F4] TR SEL
- ▶ [F5] INSERT
- ▶ [F6] DELETE

Song Job

- [F1] UNDO/REDO
- [F2] NOTE
- [F3] EVENT
- [F4] MEAS
- [F5] TRACK
- [F6] SONG

Supplementary Information

Song Job

The Song Job mode contains a comprehensive set of editing tools and data transform functions you can use to change the sound of the Song. It also includes a variety of convenient operations, such as copying or erasing data. See the Owner's Manual for instructions.

NOTICE

An "Executing..." message is shown when it takes a short amount of time to execute the Job. Never attempt to turn off the power while an "Executing..." message is shown. Turning the power off in this state results in loss of all user data.

Operation

[SONG] → Song selection → [JOB]

[F1] UNDO/REDO

The Undo Job cancels the changes you made in your most recent recording session, editing session, or Job, and restores the data to its previous state. This allows you to recover from accidental data loss. Redo is available only after using Undo, and lets you restore the changes you made before undoing them.

NOTICE

Undo/Redo does not work with Mixing Voice operations.

[F2] NOTE (Note data Job)

Pressing this calls up the selected Job display.

NOTE Before executing the Note data Job, make sure that you specify the Track (01 – 16, all) and range (measure : beat : clock) to which the Job is applied.

01: Quantize

Quantization is the process of adjusting the timing of note events by moving them closer to the nearest exact beat. You can use this feature, for example, to improve the timing of a performance recorded in real time.

TR (Track) 001 : 1 : 000 – 999 : 4 : 479

Determines the Track (01 – 16, all) and range of measures/beats/clocks over which the Job is applied.

Quantize (Resolution)

Determines to what beats the note data in the specified Track will be aligned.

Settings: 32nd note, 16th note triplet, 16th note, 8th note triplet, 8th note, 1/4 note triplet, 1/4 note, 16th note + 16th note triplet, 8th note + 8th note triplet

Strength

This parameter sets the "strength" by which note events are pulled toward the nearest quantize beats. A setting of 100% produces exact timing. A setting of 0% results in no quantization.

Settings: 000% – 100%

SwingRate

Delays notes on even-numbered beats (backbeats) to produce a swing feel. For example, if the meter is 4/4 and the quantize value is quarter notes, the 2nd and 4th beats of the measure will be delayed. When a triplet quantize value is used, the last note of each triplet is delayed. When the quantize value is even-numbered, beats will be delayed.

Settings: The range differs depending on Quantize setting. For details, see below.

If the quantize value is 1/4 note, 8th note, 16th note, 32nd note:

A setting of 100% is equivalent to twice the length of the specified quantize value. A setting of 50% produces exact timing and therefore no swing feel. Settings above 51% increase the amount of swing, with 75% being equivalent to a dotted-note delay.

If the quantize value is 1/4 note triplet, 8th note triplet, 16th note triplet:

A setting of 100% is equivalent to three times the length of the specified quantize value. A setting of 66% produces exact timing and therefore no swing feel. Settings above 67% increase the amount of swing, with 83% being equivalent to a sextuplet delay.

If the quantize value is 8th note + 8th note triplet, 16th note + 16th note triplet:

A setting of 100% is equivalent to twice the length of a 8th note or 16th note. A setting of 50% produces exact timing and therefore no swing feel. Settings above 51% increase the amount of swing, with 66% being equivalent to a triplet delay.

NOTE If a swing value other than 100% results in notes being positioned after other non-swing notes, the latter notes are delayed accordingly.

Song Mode

Song Play

[F1] PLAY
[F2] GROOVE
[F3] TRACK
[F6] CHAIN

Song Record

Song Record Standby

[F1] SETUP
[F2] VOICE
[F3] ARP ED
[F5] CLICK
[F6] ALL TR

During Song Recording

[F1] SETUP
[F3] REST
[F4] TIE
[F5] DELETE
[F6] BAK DEL

Arpeggio Edit

[F1] COMMON
[F2] TYPE
[F3] MAIN
[F4] LIMIT
[F5] PLAY FX
[F6] OUT CH

Song Edit

[F1] CHANGE
[F2] VIEW FLT
[F4] TR SEL
[F5] INSERT
[F6] DELETE

Song Job

▶ [F1] UNDO/REDO
▶ [F2] NOTE
[F3] EVENT
[F4] MEAS
[F5] TRACK
[F6] SONG

Supplementary Information

GateTime

Determines the gate time (the length of time a note sounds) of the even-numbered backbeat notes to enhance the swing feel. When a triplet quantize value is used, the gate time of the last note of each triplet is adjusted. When the quantize value is 8th note + 8th note triplet or 16th note + 16th note triplet, the gate time of the even-numbered 8th note or 16th note beats will be adjusted. A setting of 100% leaves the original gate time unchanged. If an adjusted gate time value is less than 1, the value is rounded off to 1.

Settings: 000% – 200%

02: Modify Velocity

This Job alters the velocity values of the specified range of notes, letting you selectively boost or cut the volume of those notes. Velocity changes are calculated as follows:

$$\text{Adjusted velocity} = (\text{original velocity} \times \text{Rate}) + \text{Offset}$$

If the result is 0 or less, the value is set to 1. If the result is higher than 127, the value is set to 127.

TR (Track) 001 : 1 : 000 – 999 : 4 : 479

Determines the Track (01 – 16, all) and range of measures/beats/clocks over which the Job is applied.

SetAll

Sets the velocities of all target notes to the same fixed value (1 to 127). When set to "OFF" the Set All parameter has no effect. When this is set to a value other than "off," the Rate and Offset parameters are unavailable and appear as "****" on the display.

Settings: off (0), 001 – 127

Rate

Determines the percentage by which the target notes will be shifted from their original velocities. Settings below 100% reduce the velocities, and settings above 100% increase the velocities proportionately. A setting of 100 produces no change. When the Set All parameter is not set to "off," this parameter appears as "****" and cannot be changed.

Settings: 000% – 200%, ***

Offset

Adds a fixed value to the Rate-adjusted velocity values. Settings below 0 reduce the velocities, and settings above 0 increase the velocities. A setting of 0 produces no change. When the Set All parameter is not set to "off," this parameter appears as "****" and cannot be changed.

Settings: -127 – +0 – +127, ***

03: Modify Gate Time

This Job alters the gate times of the specified range of notes. Gate time changes are calculated as follows:

$$\text{Adjusted gate time} = (\text{original gate time} \times \text{Rate}) + \text{Offset}$$

If the result is 0 or less, the value is rounded off to 1.

TR (Track) 001 : 1 : 000 – 999 : 4 : 479

Determines the Track (01 – 16, all) and range of measures/beats/clocks over which the Job is applied.

SetAll

Sets the gate times of all target notes to the same fixed value. When set to "OFF," the Set All parameter has no effect. When set to a value other than "off," the Rate and Offset parameters are unavailable and appear as "****" on the display.

Settings: off (0), 0001 – 9999

Rate

Determines the percentage by which the gate time of the target notes will be changed. Settings below 100% shorten the notes, and settings above 100% lengthen the notes proportionately. A setting of 100 produces no change. When the Set All parameter is not set to "off," this parameter appears as "****" and cannot be changed.

Settings: 000% – 200%, ***

Offset

Adds a fixed value to the Rate-adjusted gate time values. Settings below 0 shorten the gate time, and settings above 0 lengthen the gate time. A setting of 0 produces no change. When the Set All parameter is not set to "off," this parameter appears as "****" and cannot be changed.

Settings: -9999 – +0 – +9999, ***

Song Mode

Song Play

- [F1] PLAY
- [F2] GROOVE
- [F3] TRACK
- [F6] CHAIN

Song Record

Song Record Standby

- [F1] SETUP
- [F2] VOICE
- [F3] ARP ED
- [F5] CLICK
- [F6] ALL TR

During Song Recording

- [F1] SETUP
- [F3] REST
- [F4] TIE
- [F5] DELETE
- [F6] BAK DEL

Arpeggio Edit

- [F1] COMMON
- [F2] TYPE
- [F3] MAIN
- [F4] LIMIT
- [F5] PLAY FX
- [F6] OUT CH

Song Edit

- [F1] CHANGE
- [F2] VIEW FLT
- [F4] TR SEL
- [F5] INSERT
- [F6] DELETE

Song Job

- [F1] UNDO/REDO
- ▶ [F2] NOTE
- [F3] EVENT
- [F4] MEAS
- [F5] TRACK
- [F6] SONG

Supplementary Information

04: Crescendo

This Job lets you create a crescendo or decrescendo over the specified range of notes. (Crescendo is a gradual increase in volume, and decrescendo is a gradual decrease.)

TR (Track) 001 : 1 : 000 – 999 : 4 : 479

Determines the Track (01 – 16, all) and range of measures/beats/clocks over which the Job is applied.

VelocityRange

Determines the intensity of the crescendo or decrescendo. The velocity values of the notes in the specified range are gradually increased or decreased starting at the first note in the range. The velocity of the last note in the range becomes the original velocity of the note plus the Velocity Range value. If the resultant velocity is outside the 1 – 127 range, it is set to 1 or 127 accordingly. Settings greater than 0 produce a crescendo, and settings less than 0 produce a decrescendo. A setting of 0 produces no effect.

Settings: -127 – +0 – +127

NOTE Executing this Job changes velocities of the note on events in the specified range to produce the crescendo/decrescendo. Note that this Job cannot apply the crescendo/decrescendo to long sustained notes having a long gate time. If you wish to do this, use the “Create Continuous Data” Job (page 92) with the Event Type set to “Control Change 11.”

05: Transpose

Transpose lets you change the key or pitch of the notes in the specified range.

TR (Track) 001 : 1 : 000 – 999 : 4 : 479

Determines the Track (01 – 16, all) and range of measures/beats/clocks over which the Job is applied.

Note

Determines the range of note pitches over which the Job is applied. You can also set the note directly from the keyboard, by holding down the [SF6] KBD button and pressing the desired key.

Settings: C -2 – G8

Transpose

Transposes notes in the specified range (in semitones). A setting of +12 transposes up one octave, while a setting of -12 transposes down an octave. A setting of 0 produces no change.

Settings: -127 – +0 – +127

06: Glide

The Glide Job replaces all notes following the first note in the specified range with pitch bend data, producing smooth glides from note to note. This is ideal for producing slide-guitar or string-bending effects.

TR (Track) 001 : 1 : 000 – 999 : 4 : 479

Determines the Track (01 – 16, all) and range of measures/beats/clocks over which the Job is applied.

GlideTime

Determines the time of the glide. Higher values produce a longer glide between notes.

Settings: 000 – 100

PBRange (Pitch Bend Range)

Determines the maximum pitch bend range to be applied by the Glide Job (in semitones).

Settings: 01 – 24

NOTE Please note that the Song may not play back properly if you set the “PB Range” to a value different from the one set via the Voice Edit mode. In order that the Song plays back properly, insert the MIDI event below to the corresponding Track in the Song Edit display (page 84).

RPN [000-000] xxx (“xxx” represents the Pitch Bend value)

07: Create Roll

This Job creates a series of repeated notes (like a drum roll) in the specified range with the specified continuous changes in clock step and velocity. This is ideal for creating fast staccato rolls and special stuttering effects.

TR (Track) 001 : 1 : 000 – 999 : 4 : 479

Determines the Track (01 – 16) and range of measures/beats/clocks over which the Job is applied.

Song Mode

Song Play

- [F1] PLAY
- [F2] GROOVE
- [F3] TRACK
- [F6] CHAIN

Song Record

Song Record Standby

- [F1] SETUP
- [F2] VOICE
- [F3] ARP ED
- [F5] CLICK
- [F6] ALL TR

During Song Recording

- [F1] SETUP
- [F3] REST
- [F4] TIE
- [F5] DELETE
- [F6] BAK DEL

Arpeggio Edit

- [F1] COMMON
- [F2] TYPE
- [F3] MAIN
- [F4] LIMIT
- [F5] PLAY FX
- [F6] OUT CH

Song Edit

- [F1] CHANGE
- [F2] VIEW FLT
- [F4] TR SEL
- [F5] INSERT
- [F6] DELETE

Song Job

- [F1] UNDO/REDO
- ▶ [F2] NOTE
- [F3] EVENT
- [F4] MEAS
- [F5] TRACK
- [F6] SONG

Supplementary Information

StartStep (Starting Step)**EndStep (Ending Step)**

Determines the size of the step (i.e., the number of clocks) between each note in the roll. The smaller the value, the finer the roll. Both the starting and ending clock values can be specified, making it easy to create rolls in which the step size varies during the roll.

Settings: StartStep: 001 – 999, EndStep: 001 – 999

Note

Determines the specific note (or instrument in Drum voices) for the roll effect. You can also set the note directly from the keyboard, by holding down the [SF6] KBD button and pressing the desired key.

Settings: C -2 – G8

StartVelo (Starting Velocity)**EndVelo (Ending Velocity)**

Determines the velocity of the notes in the roll. Both the starting and ending velocity values can be specified, making it easy to create rolls in which the velocity increases or decreases. This lets you create rolls that gradually increase or decrease in volume (crescendo/decrecendo)

Settings: StartVelo: 001 – 127, EndVelo: 001 – 127

08: Sort Chord

This Job sorts chord events (simultaneous note events) by order of pitch. The sort affects the order of the notes in the event list display (page 84), but does not change the timing of the notes. When used to pre-process chords before using the Separate Chord Job (below), Chord Sort can be used to simulate the "stroke" or strumming sound of guitars and similar instruments.

TR (Track) 001 : 1 : 000 – 999 : 4 : 479

Determines the Track (01 – 16, all) and range of measures/beats/clocks over which the Job is applied.

Type

Determines how the chord note data is sorted.

Settings: up, down, up&down, down&up

up The notes are sorted in ascending order. After executing this Job with this setting, execute the Separate Chord Job to create a guitar-like upstroke strum.

down..... The notes are sorted in descending order. After executing this Job with this setting, execute the Separate Chord Job to create a guitar-like downstroke strum.

up&down Sorts chord notes on downbeats in ascending order and chord notes on upbeats in descending order, based on the Grid setting (below).

down&up Sorts chord notes on downbeats in descending order and chord notes on upbeats in ascending order, based on the Grid setting (below).

Grid

Determines the type of note that serves as the basis for the Chord Sort Job.

Settings: 32nd note, 16th note triplet, 16th note, 8th note triplet, 8th note, 1/4 note triplet, 1/4 note

09: Separate Chord

This Job slightly separates notes in chords within the specified range, inserting a specified number of clocks between each note. Use this Job after the Chord Sort Job above, to create guitar-like upstroke or downstroke effects.

TR (Track) 001 : 1 : 000 – 999 : 4 : 479

Determines the Track (01 – 16, all) and range of measures/beats/clocks over which the Job is applied.

Clock

Determines the number of clock cycles inserted between adjacent chord notes.

Settings: 000 – 999

NOTE Note that there are 480 clock cycles per quarter note.

NOTE It is not possible to separate chords so that they cross into the next chord or they overstep the range (set above).

Song Mode**Song Play**

- [F1] PLAY
- [F2] GROOVE
- [F3] TRACK
- [F6] CHAIN

Song Record**Song Record Standby**

- [F1] SETUP
- [F2] VOICE
- [F3] ARP ED
- [F5] CLICK
- [F6] ALL TR

During Song Recording

- [F1] SETUP
- [F3] REST
- [F4] TIE
- [F5] DELETE
- [F6] BAK DEL

Arpeggio Edit

- [F1] COMMON
- [F2] TYPE
- [F3] MAIN
- [F4] LIMIT
- [F5] PLAY FX
- [F6] OUT CH

Song Edit

- [F1] CHANGE
- [F2] VIEW FLT
- [F4] TR SEL
- [F5] INSERT
- [F6] DELETE

Song Job

- [F1] UNDO/REDO
- ▶ [F2] NOTE
- [F3] EVENT
- [F4] MEAS
- [F5] TRACK
- [F6] SONG

Supplementary Information

[F3] EVENT (Event Job)

Pressing this calls up the selected Job display.

NOTE Before executing the Event Job, make sure that you specify the Track and range (measure: beat: clock) to which the Job is applied. Please note that the Track to be specified varies depending on the Job.

01: Shift Clock

This Job shifts all data events in the specified range forward or backward by the specified number of clocks.

TR (Track) 001 : 1 : 000 – 999 : 4 : 479

Determines the Track (01 – 16, TMP=tempo, SCN=scene, all) and range of measures/beats/clocks over which the Job is applied.

Clock

Determines the amount by which the data will be delayed or advanced in measures, beats, and clocks.

Settings: 000: 0: 000 – 999: 3: 479

Direction

Determines the direction in which the data will be shifted. Advance moves the data toward the beginning of the sequence, while Delay shifts the data toward the end of the sequence.

Settings: Advance, Delay

02: Copy Event

This Job copies all data from a specified source range to a specified destination location. Execute this Job after setting:

- Source Track (01-16, TMP, SCN, all)
- Source range (measure : beat : clock)
- Destination Track (01-16, TMP, SCN, all)
- Destination range (measure : beat : clock)
- Top measure of destination
- Count (number of times data is to be copied)

NumberOfTimes

Determines the number of times the data is copied.

Settings: x01 – x99

NOTICE

When Copy Event is executed, any data already existing at the Destination location will be overwritten.

03: Erase Event

This Job clears all specified events from the specified range, effectively producing a segment of silence.

TR (Track) 001 : 1 : 000 – 999 : 4 : 479

Determines the Track (01 – 16, TMP, SCN, all) and range of measures/beats/clocks over which the Job is applied.

EventType

Determines the event type to be erased. All events are cleared when ALL is selected. Individual control change numbers can be specified when erasing control change events.

Settings: When TR is set to 01 – 16: Note (Note events), PC (Program Change), PB (Pitch Bend), CC (Control Change)*, CAT (Channel Aftertouch), PAT (Polyphonic Aftertouch), EXC (System Exclusive), All (all events)

When TR is set to "TMP" (Tempo): TMP (tempo)

When TR is set to "SCN" (Scene): SceneMemory (Scene change information), TrackMute (Track mute setting change information)

* You can also specify the CC No. (Control Change number).

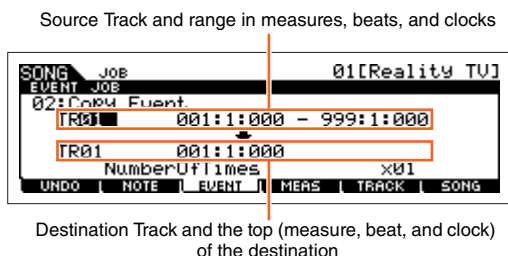

Song Mode

Song Play

- [F1] PLAY
- [F2] GROOVE
- [F3] TRACK
- [F6] CHAIN

Song Record

Song Record Standby

- [F1] SETUP
- [F2] VOICE
- [F3] ARP ED
- [F5] CLICK
- [F6] ALL TR

During Song Recording

- [F1] SETUP
- [F3] REST
- [F4] TIE
- [F5] DELETE
- [F6] BAK DEL

Arpeggio Edit

- [F1] COMMON
- [F2] TYPE
- [F3] MAIN
- [F4] LIMIT
- [F5] PLAY FX
- [F6] OUT CH

Song Edit

- [F1] CHANGE
- [F2] VIEW FLT
- [F4] TR SEL
- [F5] INSERT
- [F6] DELETE

Song Job

- [F1] UNDO/REDO
- [F2] NOTE
- [F3] EVENT
- [F4] MEAS
- [F5] TRACK
- [F6] SONG

Supplementary Information

04: Extract Event

This Job moves all instances of specified event data from a specified range of a Track to the same range in a different Track.

TR (Track) 001 : 1 : 000 – 999 : 4 : 479

Determines the Track (01 – 16) and range of measures/beats/clocks over which the Job is applied.

EventType

Selects the event type to be extracted. Specific note and control change numbers can also be specified as required.

Settings: Note, PC (Program Change), PB (Pitch Bend), CC (Control Change), CAT (Channel Aftertouch), PAT (Polyphonic Aftertouch), EXC (System Exclusive)

→ TR (Track)

Determines the destination Track (01 – 16).

05: Create Continuous Data

This Job creates continuous pitch bend or control change data over the specified range.

TR (Track) 001 : 1 : 000 – 999 : 4 : 479

Determines the Track (01 – 16, TMP, all) and range of measures/beats/clocks over which the Job is applied.

EventType

Determines the event type to be created.

Settings: PB (Pitch Bend), CC (Control Change)*, CAT (Channel Aftertouch), EXC (System Exclusive), TMP (Tempo)
* You can also specify the CC No. (Control Change number).

Data (Data Range)

Determines the lower and upper limits for the data range to be created.

Settings: When Event Type is set to PB: -8192 – +0 – +8191
When Event Type is set to TMP: 005.0 – 300.0
When Event Type is set to other: 0 – 127

Clock

Determines the number of clocks to be inserted between each created event.

Settings: 001 – 999

Curve

Determines the "curve" of the continuous data. Refer to the graph for approximate curve shapes.

Settings: -16 – +0 – +16

NumberOfTimes

Determines the number of times the data creation is to be repeated. For example, if data is created in the range M001:1:000 – M003:1:000 and this parameter is set to 03, the same data will be created at M003:1:000 – M005:1:000 and M005:1:000 – M007:1:000. This Job lets you insert repeated volume or filter cutoff variations to create tremolo or wah effects.

Settings: x01 – x99

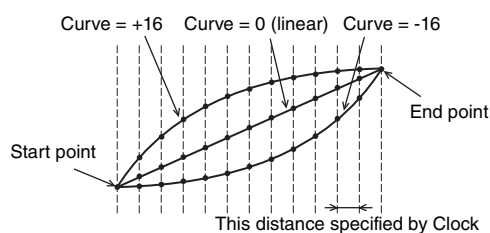

Song Mode

Song Play

- [F1] PLAY
- [F2] GROOVE
- [F3] TRACK
- [F6] CHAIN

Song Record

Song Record Standby

- [F1] SETUP
- [F2] VOICE
- [F3] ARP ED
- [F5] CLICK
- [F6] ALL TR

During Song Recording

- [F1] SETUP
- [F3] REST
- [F4] TIE
- [F5] DELETE
- [F6] BAK DEL

Arpeggio Edit

- [F1] COMMON
- [F2] TYPE
- [F3] MAIN
- [F4] LIMIT
- [F5] PLAY FX
- [F6] OUT CH

Song Edit

- [F1] CHANGE
- [F2] VIEW FLT
- [F4] TR SEL
- [F5] INSERT
- [F6] DELETE

Song Job

- [F1] UNDO/REDO
- [F2] NOTE
- ▶ [F3] EVENT
- [F4] MEAS
- [F5] TRACK
- [F6] SONG

Supplementary Information

06: Thin Out

This Job thins out the specified type of continuous data in the specified range—allowing you to free up memory space for other data or further recording.

TR (Track) 001 : 1 : 000 – 999 : 4 : 479

Determines the Track (01 – 16, all) and range of measures/beats/clocks over which the Job is applied.

EventType

Determines the event type to be thinned.

Settings: PB (Pitch Bend), CC (Control Change)*, CAT (Channel Aftertouch), PAT (Polyphonic Aftertouch), TMP (Tempo)
* You can also specify the CC No. (Control Change number).

NOTE The Thin Out Job will not work on continuous data that has a clock interval of greater than 60 clocks per event.

07: Modify Control Data

This Job lets you change the values of a specified type of control change data (for example, pitch bend, control change, aftertouch, etc.) in the specified range. Data changes are calculated as follows:

$$\text{Modified value} = (\text{original value} \times \text{Rate}) + \text{Offset.}$$

Any result lower than the minimum is set to the minimum; any result higher than the maximum is set to the maximum.

TR (Track) 001 : 1 : 000 – 999 : 4 : 479

Determines the Track (01 – 16, TMP, all) and range of measures/beats/clocks over which the Job is applied.

EventType

Determines the event type to be modified.

Settings: PB (Pitch Bend), CC (Control Change)*, CAT (Channel Aftertouch), PAT (Polyphonic Aftertouch), TMP (Tempo)
* You can also specify the CC No. (Control Change number).

SetAll

Sets all target events to the same fixed value. When set to “off” the Set All parameter has no effect. When set to a value other than “off,” the Rate and Offset parameters are unavailable and appear as “****” on the display.

Settings: off, 000 -127 (-8192 – +0 – +8191 for pitch bend, 005.0 – 300.0 for tempo), ***

Rate

Determines the percentage by which the target events will be shifted from their original values. When the Set All parameter is not set to “off,” this parameter appears as “****” and cannot be changed.

Settings: 000% – 200%, ***

Offset

Adds a fixed value to the Rate-adjusted event values. When the Set All parameter is not set to “off,” this parameter appears as “****” and cannot be changed.

Settings: -127- +0 – +127 (-8192 – +0 – +8191 for pitch bend, -275 – +0 – +275 for tempo), ***

08: Beat Stretch

This Job performs time-expansion or compression over the selected range. Keep in mind that this operation affects all event timing, note step times, and note gate times.

TR (Track) 001 : 1 : 000 – 999 : 4 : 479

Determines the Track (01 – 16, all) and range of measures/beats/clocks over which the Job is applied.

Rate

Determines the amount of time expansion or compression as a percentage. Settings higher than 100% produce expansion, and settings below 100% produce compression. A setting of 100 produces no change.

Settings: 025% – 400%

Song Mode

Song Play

- [F1] PLAY
- [F2] GROOVE
- [F3] TRACK
- [F6] CHAIN

Song Record

Song Record Standby

- [F1] SETUP
- [F2] VOICE
- [F3] ARP ED
- [F5] CLICK
- [F6] ALL TR

During Song Recording

- [F1] SETUP
- [F3] REST
- [F4] TIE
- [F5] DELETE
- [F6] BAK DEL

Arpeggio Edit

- [F1] COMMON
- [F2] TYPE
- [F3] MAIN
- [F4] LIMIT
- [F5] PLAY FX
- [F6] OUT CH

Song Edit

- [F1] CHANGE
- [F2] VIEW FLT
- [F4] TR SEL
- [F5] INSERT
- [F6] DELETE

Song Job

- [F1] UNDO/REDO
- [F2] NOTE
- ▶ [F3] EVENT
- [F4] MEAS
- [F5] TRACK
- [F6] SONG

Supplementary Information

[F4] MEAS (Measure Job)

Pressing this calls up the selected Job display.

01: Create Measure

This Job creates empty measures at the specified location in all Tracks.

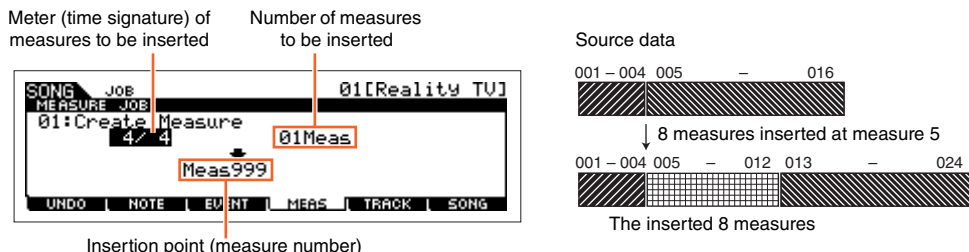

Meter of measures to be inserted

Determines the meter or time signature of the measures to be created. You may find it convenient to use this parameter when you need to create a Song that incorporates meter changes.

Settings: 1/16 – 16/16, 1/8 – 16/8, 1/4 – 8/4

Insertion point (Measure number)

Determines the insert point (measure number) at which the newly created blank measures will be inserted.

Settings: 001 – 999

Number of measures to be inserted

Determines the number of empty measures to be created and inserted.

Settings: 01 – 99

NOTE When empty measures are inserted, measure and meter data following the insert point are moved forward accordingly.

NOTE If the insert point is set after the last measure containing data, only the meter data at that point is set without actually inserting the measures.

02: Delete Measure

This job deletes the specified measures of the current Song. Measure and meter data following the deleted measures are moved backward accordingly.

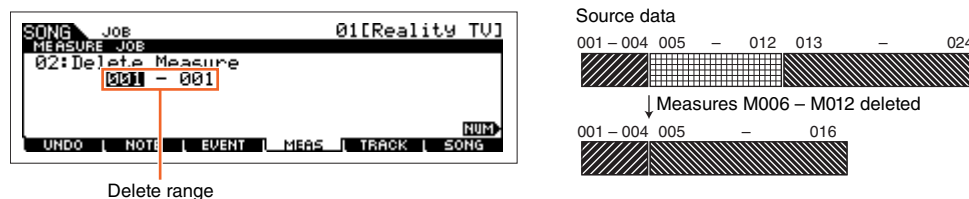

Delete range

Settings: 001 – 999

Song Mode

Song Play

- [F1] PLAY
- [F2] GROOVE
- [F3] TRACK
- [F6] CHAIN

Song Record

Song Record Standby

- [F1] SETUP
- [F2] VOICE
- [F3] ARP ED
- [F5] CLICK
- [F6] ALL TR

During Song Recording

- [F1] SETUP
- [F3] REST
- [F4] TIE
- [F5] DELETE
- [F6] BAK DEL

Arpeggio Edit

- [F1] COMMON
- [F2] TYPE
- [F3] MAIN
- [F4] LIMIT
- [F5] PLAY FX
- [F6] OUT CH

Song Edit

- [F1] CHANGE
- [F2] VIEW FLT
- [F4] TR SEL
- [F5] INSERT
- [F6] DELETE

Song Job

- [F1] UNDO/REDO
- [F2] NOTE
- [F3] EVENT
- [F4] MEAS
- [F5] TRACK
- [F6] SONG

Supplementary Information

[F5] TRACK (Track Job)

Pressing this calls up the selected Job display.

01: Copy Track

This Job copies all data of the selected type from a specified source Track to a specified destination Track.

NOTICE

The copy operation overwrites any data previously existing on the destination Track.

Data type to be copied

Determines the type(s) of data to be copied. Select the desired type by check-marking the appropriate box.

Settings: Seq Event (all events in the Track), Grid Groove (for the selected Track), Mix Part Param (all Mixing Part parameters)

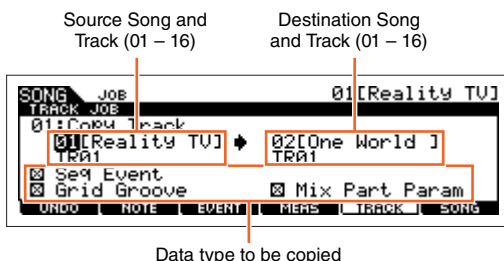

02: Exchange Track

This Job exchanges or “swaps” the specified type of data between two specified Tracks in the current Song.

Data Type to be exchanged

Determines the type(s) of data to be exchanged. Select the desired type by check-marking the appropriate box.

Settings: Seq Event (all events in the Track), Grid Groove (for the selected Track), Mix Part Param (all Mixing Part parameters)

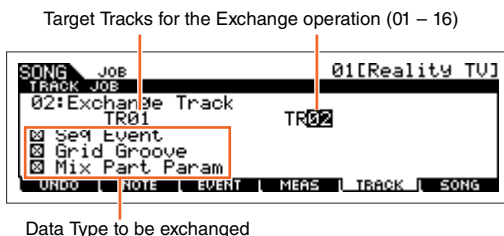

03: Mix Track

This job mixes all data from two selected Tracks (“A” and “B”), and places the result in Track B.

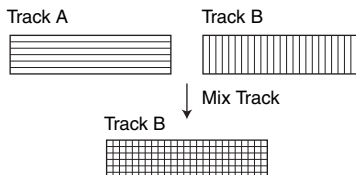
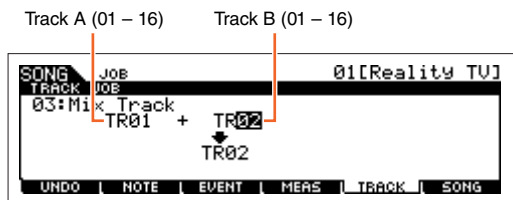

Target Tracks for the Mix operation

Settings: 01 - 16

04: Clear Track

This Job deletes all data of the selected type from the selected Pattern Track.

Data type to be cleared

Determines the type(s) of data to be cleared. Select the desired type by check-marking the appropriate box.

Settings: Seq Event (all events in the Track), Grid Groove (for the selected Track), Mix Part Param (all Mixing Part parameters)

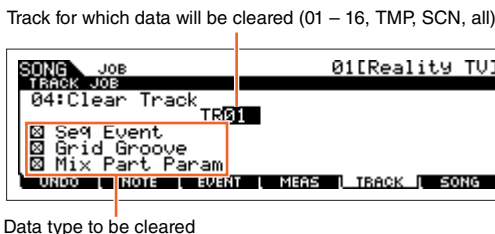

Song Mode

Song Play

- [F1] PLAY
- [F2] GROOVE
- [F3] TRACK
- [F6] CHAIN

Song Record

Song Record Standby

- [F1] SETUP
- [F2] VOICE
- [F3] ARP ED
- [F5] CLICK
- [F6] ALL TR

During Song Recording

- [F1] SETUP
- [F3] REST
- [F4] TIE
- [F5] DELETE
- [F6] BAK DEL

Arpeggio Edit

- [F1] COMMON
- [F2] TYPE
- [F3] MAIN
- [F4] LIMIT
- [F5] PLAY FX
- [F6] OUT CH

Song Edit

- [F1] CHANGE
- [F2] VIEW FLT
- [F4] TR SEL
- [F5] INSERT
- [F6] DELETE

Song Job

- [F1] UNDO/REDO
- [F2] NOTE
- [F3] EVENT
- [F4] MEAS
- [F5] TRACK
- [F6] SONG

Supplementary Information

05: Normalize Play Effect

This Job rewrites the data in the selected Track so that it incorporates the current Grid Groove settings.

TR (Track)

Determines the Song Track to which the Job is applied.

Settings: 01 – 16, all

06: Divide Drum Track

Separates the note events in a drum performance assigned to a specified Track, and places the notes corresponding to different drum instruments in separate Tracks (Tracks 1 through 8).

TR (Track)

Determines the Song Track to which the Job is applied.

Settings: 01 – 16

07: Put Track To Arp (Put Track to Arpeggio)

This Job copies data in the specified measures of a Track for creating Arpeggio data. For details, see [page 126](#).

08: Copy Phrase

This Job copies the Phrase (created in the Pattern mode) to a specified track of the current Song.

NOTICE

This Job overwrites any data already existing in the destination track with the exception of the Mixing setup.

[F6] SONG (Song Job)

Pressing this calls up the selected Job display.

01: Copy Song

This Job copies all data from a selected source Song to a selected destination Song. The Mixing Voices used by the source Song are also copied.

NOTICE

This Job overwrites any data already existing in the destination Song.

02: Split Song To Pattern

This Job allows you to copy a part of the current Song—all 16 Tracks over a specific range of measures.

NOTICE

This Job overwrites any data already existing in the destination Pattern and Section.

03: Clear Song

This job deletes all data (including the Mixing Voices) from the selected Song or all Songs. It can also be used to delete all 64 Songs at the same time.

04: Song Name

This Job lets you assign a name to the selected Song. For detailed instructions on naming, see the “Basic Operation” of the Owner’s Manual.

Song Mode

Song Play

- [F1] PLAY
- [F2] GROOVE
- [F3] TRACK
- [F6] CHAIN

Song Record

Song Record Standby

- [F1] SETUP
- [F2] VOICE
- [F3] ARP ED
- [F5] CLICK
- [F6] ALL TR

During Song Recording

- [F1] SETUP
- [F3] REST
- [F4] TIE
- [F5] DELETE
- [F6] BAK DEL

Arpeggio Edit

- [F1] COMMON
- [F2] TYPE
- [F3] MAIN
- [F4] LIMIT
- [F5] PLAY FX
- [F6] OUT CH

Song Edit

- [F1] CHANGE
- [F2] VIEW FLT
- [F4] TR SEL
- [F5] INSERT
- [F6] DELETE

Song Job

- [F1] UNDO/REDO
- [F2] NOTE
- [F3] EVENT
- [F4] MEAS
- [F5] TRACK
- [F6] SONG

Supplementary Information

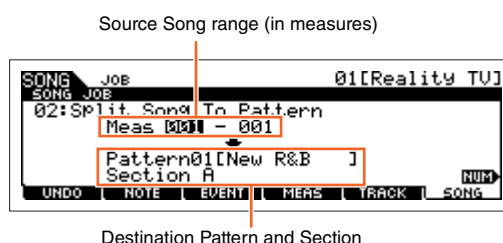
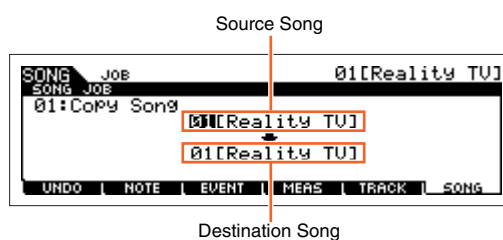

Supplementary Information

■ Song Playback Types

Playback from the middle of the Song

To start playback of the Song from midway through the Song, set the desired location by using the controls below, then press the [▶] (Play) button. These operations can also be executed during playback.

Forward	Press the [▶▶] (Forward) button.
Fast forward	Hold the [▶▶] (Forward) button.
Rewind	Press the [◀◀] (Rewind) button.
Fast Rewind	Hold the [◀◀] (Rewind) button.
Move to the top of the Song	Press the [◀] (Top) button.
Move to location 1	While holding the [◀] (Top) button, press the [◀◀] (Rewind) button.
Move to location 2	While holding the [◀] (Top) button, press the [▶▶] (Forward) button.

When the Song does not play back properly:

Keep in mind that starting a Song from somewhere in the middle may cause playback problems, such as the wrong sound, incorrect pitch or unexpected volume changes. This may occur because the MIDI events recorded at the start of the Song have not been recognized by the tone generator section, since playback has started at a different point in the Song, with different MIDI events. To prevent this from happening, set the "SongEventChase" parameter (page 144) to "PC+PB+Ctrl" or "all" in the OTHER display of the Utility mode. With this setting, the Song will be played back properly even when starting playback from the middle of the Song.

Assigning specific measure numbers to Locations 1 and 2

To assign specific measure numbers to locations 1 and 2, select the desired measure number then press the [◀◀]/[▶▶] (Rewind/Forward) while holding the [REC/SET LOCATE]. The setting here will be shown at the top of the [F1] PLAY display in the Song mode.

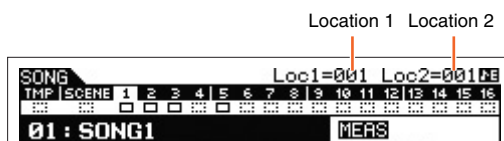

Assigning various settings related to Song playback (Song Scene)

You can assign five different "snapshots" of important Song-related parameters such as transpose, tempo, Track mute status, and the basic Song Mixing setup to the [SF1] – [SF6] buttons as Song Scenes. One of the convenient advantages of Song Scene is that it lets you instantly and automatically execute parameter settings that normally require many button presses or controller operations. Use it during Song recording or playback to make instantaneous setting changes.

Song Scene parameters

Tempo	Song Mode	PLAY display (page 76)
Transpose		GROOVE display (page 77)
Play Effect settings for 16 Tracks		[MUTE] (See the "Quick Guide" of the Owner's Manual)
Track Mute settings for 16 Tracks	Mixing mode	OUTPUT display (page 118)
Pan settings for 16 Mixing Parts		TONE display (page 118)
Volume settings for 16 Mixing Parts		
Reverb Send settings for 16 Mixing Parts		
Chorus Send settings for 16 Mixing Parts		
Cutoff Frequency settings for 16 Mixing Parts		
Resonance settings for 16 Mixing Parts		
AEG Attack settings for 16 Mixing Parts		
AEG Release settings for 16 Mixing Parts		

Song Mode

Song Play

- [F1] PLAY
- [F2] GROOVE
- [F3] TRACK
- [F6] CHAIN

Song Record

Song Record Standby

- [F1] SETUP
- [F2] VOICE
- [F3] ARP ED
- [F5] CLICK
- [F6] ALL TR

During Song Recording

- [F1] SETUP
- [F3] REST
- [F4] TIE
- [F5] DELETE
- [F6] BAK DEL

Arpeggio Edit

- [F1] COMMON
- [F2] TYPE
- [F3] MAIN
- [F4] LIMIT
- [F5] PLAY FX
- [F6] OUT CH

Song Edit

- [F1] CHANGE
- [F2] VIEW FLT
- [F4] TR SEL
- [F5] INSERT
- [F6] DELETE

Song Job

- [F1] UNDO/REDO
- [F2] NOTE
- [F3] EVENT
- [F4] MEAS
- [F5] TRACK
- [F6] SONG

Supplementary Information

Registering the Song Scene

After making the desired settings for the Scene, simultaneously hold down the [STORE] button and press one of the [SF1] to [SF6] buttons. The 8th note icon is shown in the tab corresponding to the Sub Function button to which the Song Scene is registered. Press the [STORE] button to store the Song data including the Song Scene settings.

Recalling the Song Scene

You can recall the Song Scene by pressing one of the [SF1] to [SF6] buttons in the PLAY display or other displays which show the "SCN" indication at the [SF1] – [SF6] buttons.

Song Chain Playback

Song Chain Playback allows you to put together a play list of preset Songs in any desired order, and have them automatically play back in sequence. You can set the order of Song playback then start the Chain Playback from the Song Chain display.

1 Calls up the Song Chain display (page 78).

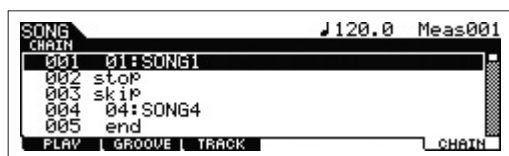

Press the [F6] CHAIN in the Song Play display.

2 Press the [▶] (Play) button to start the Song Chain playback.

The Songs are played back according to the order of the Chain. When an empty Song is assigned to the Chain number, one measure of silence is counted, followed by playback of the next Song. When a "skip" is assigned to the Chain number, the assigned Song will be ignored or skipped then the next Song will start. When a "stop" is assigned to the Chain number, playback will be stopped at the corresponding Song. Press the [▶] (Play) to restart playback from the next Chain number. If an "end" is assigned to the Chain number, playback will stop at the end of the Song.

3 If you wish to stop playback in the middle of a Song Chain, press the [■] (Stop) button.

NOTE The Song Chain can only be played back in the Song Chain display, and not from any other display.

Song Mode

Song Play

- [F1] PLAY
- [F2] GROOVE
- [F3] TRACK
- [F6] CHAIN

Song Record

Song Record Standby

- [F1] SETUP
- [F2] VOICE
- [F3] ARP ED
- [F5] CLICK
- [F6] ALL TR

During Song Recording

- [F1] SETUP
- [F3] REST
- [F4] TIE
- [F5] DELETE
- [F6] BAK DEL

Arpeggio Edit

- [F1] COMMON
- [F2] TYPE
- [F3] MAIN
- [F4] LIMIT
- [F5] PLAY FX
- [F6] OUT CH

Song Edit

- [F1] CHANGE
- [F2] VIEW FLT
- [F4] TR SEL
- [F5] INSERT
- [F6] DELETE

Song Job

- [F1] UNDO/REDO
- [F2] NOTE
- [F3] EVENT
- [F4] MEAS
- [F5] TRACK
- [F6] SONG

Supplementary Information

■ Song Track Loop – setting example

In the example below, a 40-measure Song has been recorded and Track 1 is set to play back normally over the 40 measures. Track 2 has been set to loop, and will repeat until the [■] (Stop) is pressed.

When set to on, you can specify the range to be looped. (Only the end point can be set; the start point of looped playback is fixed to the beginning of the Song.)

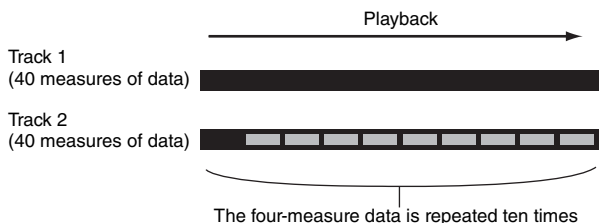

NOTICE

Please be careful to note that changing the Track Loop from off to on will delete the data of the area that is not looped.

- 1 Press the [F1] PLAY button to call up the Song Play display. Set the last measure of looped playback as desired here.

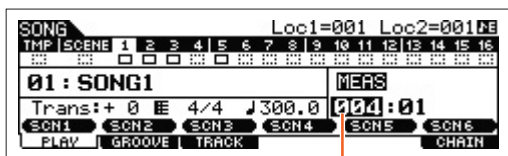

In this example, the last measure is set to "004."

- 2 Press the [F3] TRACK button and then press the [SF3] TR LOOP button to call up the Track Loop display, and move the cursor to the desired Track.

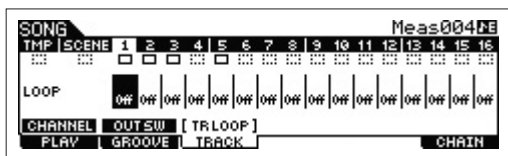

- 3 Set Track Loop to on by using the [INC] button or the [DATA] dial. (The display prompts you for confirmation.)

- 4 Press the [INC] button. The Loop is set to on and the part that is not looped is deleted.

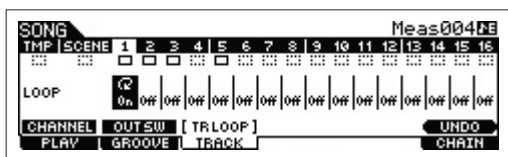

If you want to restore the deleted data and return the selected Track to off, press the [SF6] UNDO button.

NOTICE

The Undo function can only be used on the last Track Loop operation. If you've set other Tracks to loop, the original data of those previously edited Tracks cannot be recovered.

NOTICE

If you move to another display, the Undo function cannot be executed.

Song Mode

Song Play

- [F1] PLAY
- [F2] GROOVE
- [F3] TRACK
- [F6] CHAIN

Song Record

Song Record Standby

- [F1] SETUP
- [F2] VOICE
- [F3] ARP ED
- [F5] CLICK
- [F6] ALL TR

During Song Recording

- [F1] SETUP
- [F3] REST
- [F4] TIE
- [F5] DELETE
- [F6] BAK DEL

Arpeggio Edit

- [F1] COMMON
- [F2] TYPE
- [F3] MAIN
- [F4] LIMIT
- [F5] PLAY FX
- [F6] OUT CH

Song Edit

- [F1] CHANGE
- [F2] VIEW FLT
- [F4] TR SEL
- [F5] INSERT
- [F6] DELETE

Song Job

- [F1] UNDO/REDO
- [F2] NOTE
- [F3] EVENT
- [F4] MEAS
- [F5] TRACK
- [F6] SONG

Supplementary Information

■ Punch In/Out (Type = punch)

You can use this method when you want to re-record only over a specific area of the Track. You'll need to set the start and end points before re-recording. In the eight-measure example below, measures three through five are re-recorded.

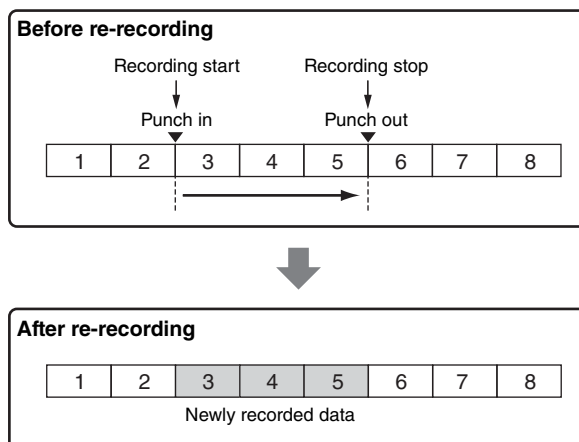

NOTE Punch In/Out Recording can only be used with Realtime recording.

NOTE Note that the Punch In/Out method always replaces (erases) the original data over the specified area.

■ Basic Procedure in the Song Job Mode

- 1 Press the [JOB] button to enter the Song Job.
- 2 Select the desired Job menu by pressing one of the [F1] – [F6] buttons.
- 3 Move the cursor to the desired Job by using the [DATA] dial, cursor buttons, [INC] and [DEC] buttons, then press the [ENTER] button to call up the Job display.
- 4 Move the cursor to the desired parameter, then set the value by using the [DATA] dial, [INC] and [DEC] buttons.
- 5 After setting, press the [ENTER] button to execute the Job.
“Completed” will appear when the Job is done.

■ NOTICE

In some Jobs, the operation overwrites any data previously existing in the destination memory. Important data should always be saved to a USB flash memory device connected to the USB TO [DEVICE] terminal.

- 6 Press the [EXIT] button twice to go back to the Song Play display.

■ NOTICE

Even if a Job operation has been completed, turning the power off without storing will erase the Song data. Make sure to store the Song data to internal memory by pressing the [STORE] button before turning the power off.

NOTE In some Jobs, you need specify the range (start point and end point as illustrated below) to which the Job is applied. Keep in mind that the end point itself is not included in the range. The actual range to which the Job is applied is from the start point to the point that is one clock less than the end point. This rule applies to cases in which you specify only the Measure; however, the example illustration below shows Measure, Beat and Clock all specified.

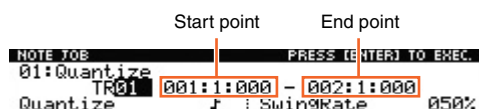

NOTE In some jobs, when the cursor is located on such a parameter, the NUM icon appears at the lower right corner of the display. In this case, you can also set this parameter by using the window for inputting a number directly called up via the [SF6] NUM button. To close the window, press the [EXIT] button

Song Mode

Song Play

- [F1] PLAY
- [F2] GROOVE
- [F3] TRACK
- [F6] CHAIN

Song Record

Song Record Standby

- [F1] SETUP
- [F2] VOICE
- [F3] ARP ED
- [F5] CLICK
- [F6] ALL TR

During Song Recording

- [F1] SETUP
- [F3] REST
- [F4] TIE
- [F5] DELETE
- [F6] BAK DEL

Arpeggio Edit

- [F1] COMMON
- [F2] TYPE
- [F3] MAIN
- [F4] LIMIT
- [F5] PLAY FX
- [F6] OUT CH

Song Edit

- [F1] CHANGE
- [F2] VIEW FLT
- [F4] TR SEL
- [F5] INSERT
- [F6] DELETE

Song Job

- [F1] UNDO/REDO
- [F2] NOTE
- [F3] EVENT
- [F4] MEAS
- [F5] TRACK
- [F6] SONG

Supplementary Information

Pattern Mode

The Pattern mode lets you play, record, edit and play your own original rhythm patterns. This section explains each parameter in four types (Pattern Play, Pattern Record, Pattern Edit, and Pattern Job).

NOTE The word “Pattern” refers to a short rhythmic passage of several measures which is looped and played back indefinitely. A Pattern includes 16 variations called “Sections.” You can use Sections by changing them during playback. A Pattern consists of 16 Tracks and can be created by assigning a Phrase to each Track from the PATCH display (page 102). For details about the Patterns, Sections and Phrases, see page 9.

Pattern Play

Pattern Play is the main “portal” by which you enter the Pattern mode, and it is here where you select and play a Pattern. You can also create your own Patterns by assembling Phrases—which are short rhythmic passages and “building blocks”—and create Pattern Chains in which Patterns can be combined together in any desired order.

Operation

Press the [PATTERN] button.

[F1] PLAY

Same as in the Song Play mode. See page 76. Note that the function of registering Scenes is not available in the Pattern mode. The [SF1] – [SF6] buttons are assigned to ARP1 (Arpeggio 1) – ARP6 (Arpeggio 6). Also, the “Loc” (Location) parameter is not in the PLAY display of the Pattern mode, and the following parameters are contained in the display.

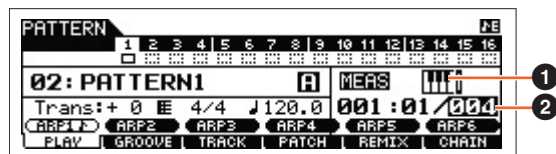

① (Keyboard Start)

When this parameter is set to on, Pattern playback begins as soon as you press a key on of the keyboard.

Settings:  (on),  (off)

NOTE From the PLAY display in the Pattern mode, you can select the Voice of the Mixing Part corresponding to the current Track by pressing the [CATEGORY SEARCH] button.

② Length

Determines the Pattern Length. This value will be the length of the Phrase created after recording.

Settings: 001 – 256

[F2] GROOVE (Grid Groove)

Same as the GROOVE display in the Song mode. See page 77.

[F3] TRACK

Same as the TRACK display in the Song mode. See page 78. Please note that the [SF6] TR LOOP display is not available in the TRACK display of the Pattern mode.

Pattern Mode

Pattern Play

- ▶ [F1] PLAY
- ▶ [F2] GROOVE
- ▶ [F3] TRACK
- [F4] PATCH
- [F5] REMIX
- [F6] CHAIN

Pattern Record

Pattern Record Standby

- [F1] SETUP
- [F2] VOICE
- [F3] ARP ED
- [F5] CLICK

During Pattern Recording

- [F1] SETUP
- [F3] RESET
- [F4] TIE
- [F5] DELETE
- [F6] BAK DEL

Pattern Edit

- [F1] CHANGE
- [F2] VIEW FLT
- [F5] INSERT
- [F6] DELETE

Pattern Job

- [F1] UNDO/REDO
- [F2] NOTE
- [F3] EVENT
- [F4] PHRASE
- [F5] TRACK
- [F6] PATTERN

Supplementary Information

[F4] PATCH

From this display, you can assign a Preset Phrase or a User Phrase (recorded in the Pattern Record mode) to each Track and create a Pattern that contains up to 16 Tracks. You can assign a User Phrase created with the currently selected Pattern. If you wish to use User Phrases recorded to Tracks of other Patterns, use the Phrase Data Copy function, selected with the [SF6] COPY button.

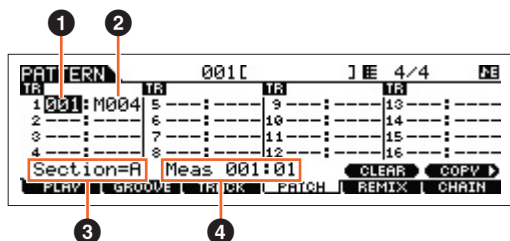

1 Phrase Number

Determines the Phrase number to be assigned to a Track. You can select one of the 256 User Phrases stored to the selected Pattern. Note that by default the User Phrases have no data. When set to "---," the Track becomes empty.

Settings: --- (off), 001 – 256

NOTE The MOXF6/MOXF8 features no Preset Phrase data.

2 Number of Measures

Indicates the name of the selected Phrase.

3 Section

Shows the Section being currently edited. To change the Section, press the [PATTERN SECTION] button, and then use the Number [1] – [16] buttons. Pressing the [PATTERN SECTION] assigns the Sections A – P to numbers [1] – [16] in sequence. Then, pressing the appropriate Number [1] – [16] buttons lets you change the Section.

4 Meas (Measure)

Shows Measure and Beat for current playback location.

[SF5] CLEAR

This clears the Phrase assignment to the currently selected Track and leaves the Track empty.

[SF6] COPY

Source Pattern number, Phrase number

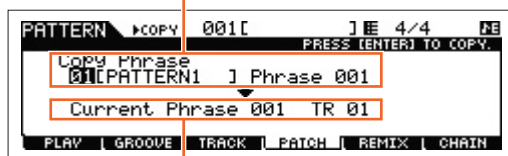

Destination Phrase and Track of the Pattern being currently edited

The User Phrases that can be assigned with the Patch function are limited to the ones contained in the currently selected Pattern. This function lets you copy Phrases in another Pattern to the selected one. Press the [SF6] to call up the following display. After setting the parameters as needed, press the [ENTER] to copy the Phrase data.

NOTICE

Any previous data in the copy destination will be overwritten. Therefore, you should regularly create backup copies of important data on a USB flash-memory device or the like.

Pattern Mode

Pattern Play

- [F1] PLAY
- [F2] GROOVE
- [F3] TRACK
- [F4] PATCH
- [F5] REMIX
- [F6] CHAIN

Pattern Record

Pattern Record Standby

- [F1] SETUP
- [F2] VOICE
- [F3] ARP ED
- [F5] CLICK

During Pattern Recording

- [F1] SETUP
- [F3] RESET
- [F4] TIE
- [F5] DELETE
- [F6] BAK DEL

Pattern Edit

- [F1] CHANGE
- [F2] VIEW FLT
- [F5] INSERT
- [F6] DELETE

Pattern Job

- [F1] UNDO/REDO
- [F2] NOTE
- [F3] EVENT
- [F4] PHRASE
- [F5] TRACK
- [F6] PATTERN

Supplementary Information

[F5] REMIX

This function gives you a variety of semi-random presets for dividing the MIDI sequence data and altering the note lengths, letting you create completely new variations of a Pattern. Set the parameters below, then press the [ENTER] button to execute the Remix operation. If you want to keep the changes, press the [SF5] OK button. To return to the original display without altering the data, press the [SF4] CANCEL button.

NOTE Since the remixed data is stored as a new Phrase and assigned to the current Track, the original Phrase data remains as an unassigned Phrase.

Type

Determines how the data in the selected Track will be divided and rearranged. The division and rearrangement rules are different for each remix type.

Settings: 1 – 16

Var (Variation)

Determines how the original MIDI sequence data will be modified.

Settings: Normal 1 – 16, Roll 1 – 16, Break 1 – 16, Fill 1 – 48

Normal 1 – 16 The original data is sliced and rearranged only. 16 variations are available.

Roll 1 – 16 In addition to rearrangement of the divided data, some portions of the data may be played with a roll effect. 16 variations are available.

Break 1 – 16 In addition to division and rearrangement, some portions of the data may be deleted to create breaks. 16 variations are available.

Fill 1 – 48 In addition to rearrangement of the divided data, some portions of the data may be played with a roll effect. 48 variations are available.

Interval

Determines the measure(s) to which Remix is applied. For example, when set to "1," Remix is applied to all measures. When set to "2," Remix is applied to the data of every 2nd measure: 2, 4, 6, 8, and so on. When set to "3," Remix is applied to the data of every 3rd measure: 3, 6, 9, 12, and so on.

Settings: 1 – 8

[F6] CHAIN

NOTE For instructions, see the "Quick Guide" of the Owner's Manual.

Pattern Chain Play

Operation [PATTERN] → [F6] CHAIN

This mode lets you play the programmed Section chain sequence created in Pattern Record and Pattern Edit. The parameters are the same as in the [F1] PLAY display (page 101).

Pattern Chain Record

Pattern Chain Record Standby mode

Operation [PATTERN] → [F6] CHAIN → [REC]

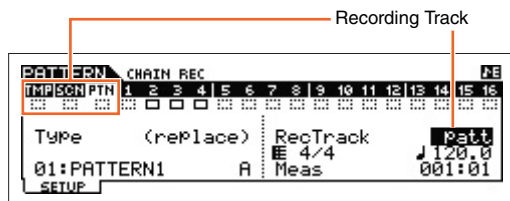

You can select one of the following Tracks for recording.

- patt (Pattern): Records Section changes during playback
- tempo: Records tempo change information during playback
- scene: Records Track mute settings during playback

Pattern Mode

Pattern Play

- [F1] PLAY
- [F2] GROOVE
- [F3] TRACK
- [F4] PATCH
- ▶ [F5] REMIX
- ▶ [F6] CHAIN

Pattern Record

Pattern Record Standby

- [F1] SETUP
- [F2] VOICE
- [F3] ARP ED
- [F5] CLICK

During Pattern Recording

- [F1] SETUP
- [F3] RESET
- [F4] TIE
- [F5] DELETE
- [F6] BAK DEL

Pattern Edit

- [F1] CHANGE
- [F2] VIEW FLT
- [F5] INSERT
- [F6] DELETE

Pattern Job

- [F1] UNDO/REDO
- [F2] NOTE
- [F3] EVENT
- [F4] PHRASE
- [F5] TRACK
- [F6] PATTERN

Supplementary Information

During Pattern Recording

Operation	[PATTERN] → [F6] CHAIN → [REC] → [▶] (Play)
------------------	---

When recording the Pattern Track, you can change the Section. When recording the tempo Track, you can change the tempo value. When the Scene Track is selected, you can record Track muting settings.

Pattern Chain Edit

Operation	[PATTERN] → [F6] CHAIN → [EDIT]
------------------	---------------------------------

[F1] CHANGE

The Pattern Chain Edit mode makes it possible to edit the order of the Sections in a chain, as well as insert tempo, and scene/mute event data. Call up the desired Track display by pressing the [F4] TR SEL button to edit the selected Track.

Pattern Track Edit

From this display, you can edit the Section changes for each measure. To set the end of the chain, enter an END mark at the appropriate measure. To clear the event at the currently selected location, press the [F6] CLEAR button.

Scene Track Edit

You can edit the Track mute change in beats. Use the [F5] INSERT and [F6] DELETE buttons to insert/delete the event.

Tempo Track Edit

You can edit the tempo change in beats. Use the [F5] INSERT and [F6] DELETE buttons to insert/delete the event.

[F2] COPY

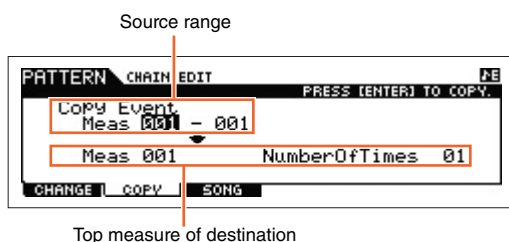

This display lets you copy all Pattern chain events from a specified range of measures (source) to a destination location. After specifying the source range in measures, the top measure of the destination location, and "NumberOfTimes" (number of times the data is copied), press the [ENTER] button to execute the Copy operation.

NOTICE

This operation overwrites any events already existing at the destination.

[F3] SONG

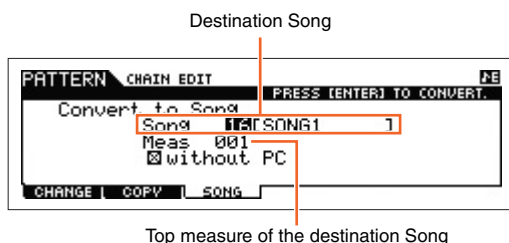

This function converts the Pattern chain data to Song data (standard MIDI format) and places the results in normal Song Tracks. After specifying the desired destination Song and measure number to which the converted data is to be copied, press the [ENTER] button to execute. When the "without PC" (without Program Change) box is checkmarked, the settings of the Mixing and Tempo are copied to the destination Song. The Tempo value is copied to the top measure of the destination Song. When the checkmark is removed, the Voice settings in each Phrase are also copied to the top measure of the destination Song as Program Change events.

NOTICE

This operation overwrites any data already existing at the destination range.

Pattern Mode

Pattern Play	
[F1]	PLAY
[F2]	GROOVE
[F3]	TRACK
[F4]	PATCH
[F5]	REMIX
[▶]	[F6] CHAIN
Pattern Record	
Pattern Record Standby	
[F1]	SETUP
[F2]	VOICE
[F3]	ARP ED
[F5]	CLICK
During Pattern Recording	
[F1]	SETUP
[F3]	RESET
[F4]	TIE
[F5]	DELETE
[F6]	BAK DEL
Pattern Edit	
[F1]	CHANGE
[F2]	VIEW FLT
[F5]	INSERT
[F6]	DELETE
Pattern Job	
[F1]	UNDO/REDO
[F2]	NOTE
[F3]	EVENT
[F4]	PHRASE
[F5]	TRACK
[F6]	PATTERN
Supplementary Information	

Pattern Record

Pattern Record Standby mode

Operation

[PATTERN] → Pattern selection → [REC]

[F1] SETUP

NOTE The Phrase length is specified by the length parameter in the PLAY display of the Pattern mode.

Type

Determines the Recording Type. The Recording Type can be divided into two groups: Realtime recording and Step recording. With Realtime recording, the instrument functions in the same way as a tape recorder, recording the performance data as it is played. This allows you to capture all the nuances of an actual performance. In Realtime recording, the "Type" should be set to "replace," "overdub," or "punch." With Step recording, you can compose your performance by "writing" it down one event at a time. This is a non-realtime, step recording method—similar to writing music notation onto paper. In Step recording, the "Type" should be set to "step."

Settings: replace, overdub, step

Loop

Turns loop recording on or off. When set to on, the Phrase will play repeatedly during Realtime recording. This can be handy when recording drum parts, allowing you to add different instruments on each pass. When set to off, recording stops after one pass through the Phrase.

Settings: off, on

Quantize

This is same as "Quantize" in the SETUP display of Song Record ([page 79](#)).

Event

This is same as "Event" in the SETUP display of Song Record ([page 79](#)).

♩ (Tempo) Knob

Determines the Pattern tempo.

Settings: 005.0 – 300

NOTE Unlike in Songs, Scene Track and Tempo Track are not available for Patterns.

NOTE If you are using this instrument with an external sequencer, DAW software, or MIDI device, and you want to synchronize it with that device, set the "MIDI Sync" parameter in the Utility MIDI display ([page 148](#)) to "external" or "auto." When "MIDI Sync" is set to "auto" (only when MIDI clock is transmitted continuously) or "external," the Tempo parameter here indicates "external" and cannot be changed.

NOTE This parameter can be set also by holding the [SHIFT] button and pressing the [ENTER] button several times repeatedly at the desired tempo. This function is referred to as "Tap Tempo."

Meas (Measure)

Determines the measure from which Pattern recording will be started.

[F2] VOICE

In this display you can set the voice related parameters for the recording Track. The settings here affect the Part for which the receive channel (set in the Mixing mode) matches the transmit (output) channel of the recording Track. Parameters are the same as in the VOICE display ([page 80](#)) in Song Record.

[F3] ARP ED (Arpeggio Edit)

Indicates the Arpeggio Edit display in the Pattern mode. Parameters are the same as in the Arpeggio Edit display ([page 82](#)) in the Song mode.

Pattern Mode

Pattern Play

[F1] PLAY
[F2] GROOVE
[F3] TRACK
[F4] PATCH
[F5] REMIX
[F6] CHAIN

Pattern Record

Pattern Record Standby

▶ [F1] SETUP
▶ [F2] VOICE
▶ [F3] ARP ED
[F5] CLICK

During Pattern Recording

[F1] SETUP
[F3] RESET
[F4] TIE
[F5] DELETE
[F6] BAK DEL

Pattern Edit

[F1] CHANGE
[F2] VIEW FLT
[F5] INSERT
[F6] DELETE

Pattern Job

[F1] UNDO/REDO
[F2] NOTE
[F3] EVENT
[F4] PHRASE
[F5] TRACK
[F6] PATTERN

Supplementary Information

[F5] CLICK

Pressing the [F5] CLICK button lets you turn the click sound (metronome) on/off for recording.

NOTE In the CLICK display ([page 144](#)), you can make various settings for the metronome click, such as the note resolution, volume, and lead-in count for recording.

During Pattern Recording

In Realtime recording, the editable parameters during recording are in the [F1] SETUP display, [F2] VOICE display, and [F3] ARP ED display of the Pattern recording standby mode. In Step recording, the displays shown during recording are different from the Song recording standby mode. In this case, the editable parameters are the same as the parameters shown during Step recording in Song Record ([page 81](#)).

Operation

[PATTERN] → Pattern selection → [REC] → [▶] (Play)

Pattern Edit

Same as Song Edit. See [page 84](#). The only difference here is that the [F4] TR SEL display is not shown.

Pattern Mode

Pattern Play

- [F1] PLAY
- [F2] GROOVE
- [F3] TRACK
- [F4] PATCH
- [F5] REMIX
- [F6] CHAIN

Pattern Record

Pattern Record Standby

- [F1] SETUP
- [F2] VOICE
- [F3] ARP ED
- ▶ [F5] CLICK

During Pattern Recording

- [F1] SETUP
- [F3] RESET
- [F4] TIE
- [F5] DELETE
- [F6] BAK DEL

Pattern Edit

- [F1] CHANGE
- [F2] VIEW FLT
- [F5] INSERT
- [F6] DELETE

Pattern Job

- [F1] UNDO/REDO
- [F2] NOTE
- [F3] EVENT
- [F4] PHRASE
- [F5] TRACK
- [F6] PATTERN

Supplementary Information

Pattern Job

The Pattern Job mode contains a comprehensive set of editing tools and functions you can use to change the sound of the Pattern. The setting instructions are the same as in the Song Job (page 87). After setting parameters as required in the selected display, press the [ENTER] button to execute the Job.

NOTICE

An “Executing...” message is shown when it takes a short amount of time to execute the Job. Never attempt to turn off the power while an “Executing...” message is shown. Turning the power off in this state results in loss of all user data.

Operation	[PATTERN] → Pattern selection → [JOB]
------------------	---------------------------------------

[F1] UNDO/REDO

The Undo Job cancels the changes you made in your most recent recording session, editing session, or Job, restoring the data to its previous state. This allows you to recover from accidental data loss. Redo is available only after using Undo, and lets you restore the changes you made before undoing them.

NOTICE

Undo/Redo does not work with Mixing Voice operations.

[F2] NOTE (Note data Job)

The Note data Jobs in the Pattern mode are basically same as in the Song Job mode. However, unlike in the Song Job, Pattern Event Jobs are applied to the Phrases (001 – 256) and a selected range in the Phrase (measure : beat : clock).

Specify the Phrase and the range (in measures/beats/clocks) over which the Job is applied.

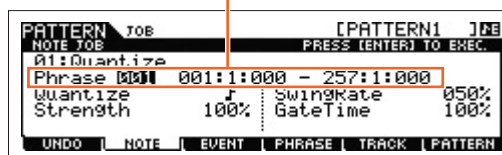

[F3] EVENT (Event Job)

The Event Jobs in the Pattern Job are basically the same as in the Song Job mode. However, unlike in the Song Job, Pattern Event Jobs are applied to the Phrases (001 – 256) and a selected range in the Phrase (measure : beat : clock).

01: Shift Clock

Same as in Song Job. See page 91.

02: Copy Event

Same as in Song Job. See page 91.

03: Erase Event

Same as in Song Job. See page 91.

NOTE Unlike in Song Job, you cannot select “Tempo,” “Scene Memory,” or “Track Mute” as Event Types.

04: Extract Event

Same as in Song Job. See page 92.

05: Create Continuous Data

Same as in Song Job. See page 92.

NOTE Unlike in Song Job, you cannot select “Tempo” as an Event Type.

Pattern Mode

Pattern Play

- [F1] PLAY
- [F2] GROOVE
- [F3] TRACK
- [F4] PATCH
- [F5] REMIX
- [F6] CHAIN

Pattern Record

Pattern Record Standby

- [F1] SETUP
- [F2] VOICE
- [F3] ARP ED
- [F5] CLICK

During Pattern Recording

- [F1] SETUP
- [F3] RESET
- [F4] TIE
- [F5] DELETE
- [F6] BAK DEL

Pattern Edit

- [F1] CHANGE
- [F2] VIEW FLT
- [F5] INSERT
- [F6] DELETE

Pattern Job

- ▶ [F1] UNDO/REDO
- ▶ [F2] NOTE
- ▶ [F3] EVENT
- [F4] PHRASE
- [F5] TRACK
- [F6] PATTERN

Supplementary Information

06: Thin Out

Same as in Song Job. See [page 93](#).

07: Modify Control Data

Same as in Song Job. See [page 93](#).

NOTE Unlike in Song Job, you cannot select "Tempo" as an Event Type.

08: Beat Stretch

Same as in Song Job. See [page 93](#).

[F4] PHRASE (Phrase Job)

01: Copy Phrase

This Job copies a selected Phrase to the designated destination Phrase. After specifying the source Pattern/Phrase, and the destination Pattern/Phrase, as well as setting the checkboxes as necessary, press the [ENTER] button to execute this Job.

NOTICE

Any previous data in the copy destination will be overwritten.

Selects the Pattern and Phrase to be copied. (Preset Phrases also can be selected.)

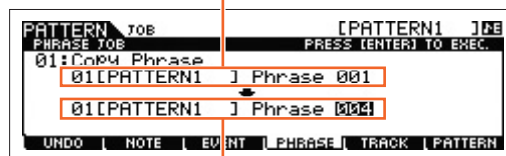

Specify the destination Pattern and Phrase.

02: Exchange Phrase

This Job exchanges or "swaps" the contents of two specified Phrases ("A" and "B").

03: Mix Phrase

This Job mixes all data from two selected user Phrases ("A" and "B"), and places the result in Phrase B.

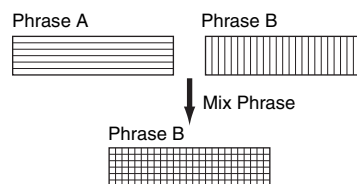

04: Append Phrase

This Job appends one Phrase (A) to the end of another (B) to create one longer Phrase (B).

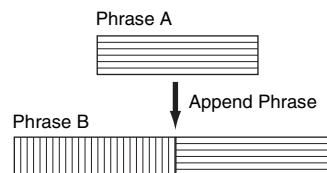

05: Split Phrase

This Job splits a selected Phrase (A) into two separate Phrases (A and B). Phrase A is divided at the Split Point. The data before the split point is stored to the original Phrase A and the data after the split point is moved and stored to Phrase B. You can also set the Meter of Phrases A and B after the Split Phrase Job is executed.

NOTE When either Pattern or Phrase is set to "off," the split Phrase B data is erased.

NOTICE

The job overwrites any data already existing in destination Phrase B.

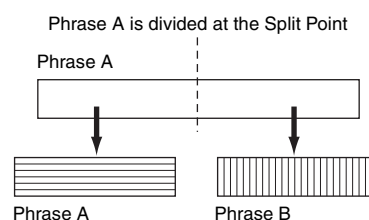

Pattern Mode

Pattern Play

- [F1] PLAY
- [F2] GROOVE
- [F3] TRACK
- [F4] PATCH
- [F5] REMIX
- [F6] CHAIN

Pattern Record

Pattern Record Standby

- [F1] SETUP
- [F2] VOICE
- [F3] ARP ED
- [F5] CLICK

During Pattern Recording

- [F1] SETUP
- [F3] RESET
- [F4] TIE
- [F5] DELETE
- [F6] BAK DEL

Pattern Edit

- [F1] CHANGE
- [F2] VIEW FLT
- [F5] INSERT
- [F6] DELETE

Pattern Job

- [F1] UNDO/REDO
- [F2] NOTE
- [F3] EVENT
- [F4] PHRASE
- [F5] TRACK
- [F6] PATTERN

Supplementary Information

06: Get Phrase From Song

This Job copies a segment of sequence-Track data from a Song into the designated destination Phrase. After specifying the source Song/Track/Measure and the destination Phrase, as well as setting the checkboxes as necessary, press the [ENTER] to execute this Job.

NOTICE

This Job overwrites any data already existing in the destination Phrase.

Source Song, Track, and range of measures to be copied.

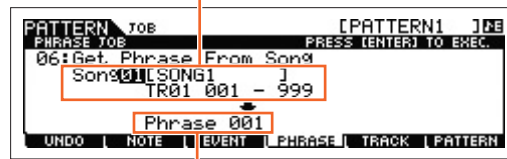

Destination Phrase

07: Put Phrase To Song

This Job copies a selected user Phrase into a specified area of a selected Song. After specifying the source Phrase and destination Song/Track/top measure, press the [ENTER] button to execute this Job.

NOTICE

This Job overwrites any data already existing in the destination Track.

Source Phrase

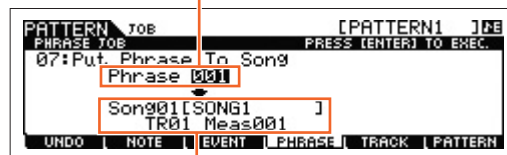

Destination Song, Track, and top measures

08: Clear Phrase

This Job deletes all data from the selected Phrase.

09: Phrase Name

This Job lets you assign a name (of up to eight characters) to the selected Phrase. For detailed instructions on naming, see the "Basic Operation" of the Owner's Manual.

[F5] TRACK (Track Job)

01: Copy Track

This Job copies all data of the selected type from a specified source Track to a specified destination Track. The types of data to be copied are the same as in Song Job. See [page 95](#).

Source Pattern, Section, and Track Destination Pattern, Section, and Track

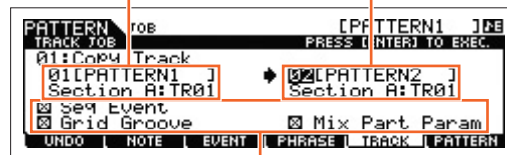

Types of data to be copied

02: Exchange Track

This Job exchanges or "swaps" the specified type of data between two specified Tracks in the current Pattern and Section. The types of data to be exchanged are the same as in Song Job. See [page 95](#).

Target Tracks for the Exchange operation

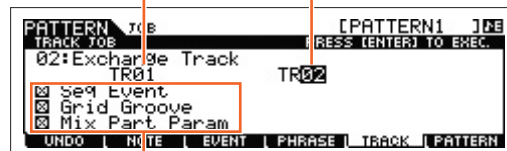

Types of data to be exchanged

Pattern Mode

Pattern Play

- [F1] PLAY
- [F2] GROOVE
- [F3] TRACK
- [F4] PATCH
- [F5] REMIX
- [F6] CHAIN

Pattern Record

Pattern Record Standby

- [F1] SETUP
- [F2] VOICE
- [F3] ARP ED
- [F5] CLICK

During Pattern Recording

- [F1] SETUP
- [F3] RESET
- [F4] TIE
- [F5] DELETE
- [F6] BAK DEL

Pattern Edit

- [F1] CHANGE
- [F2] VIEW FLT
- [F5] INSERT
- [F6] DELETE

Pattern Job

- [F1] UNDO/REDO
- [F2] NOTE
- [F3] EVENT
- ▶ [F4] PHRASE
- ▶ [F5] TRACK
- [F6] PATTERN

Supplementary Information

03: Clear Track

This Job deletes all data of the selected type from the selected Pattern Track. The types of data to be cleared are the same as in Song Job. See [page 95](#).

Section and Track from which data is to be cleared

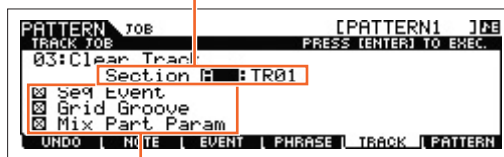

Types of data to be cleared

04: Normalize Play Effect

This Job rewrites the data in the selected Track so that it incorporates the current Grid Groove settings. After specifying a Track (TR 01 – 16) to which this Job is applied, press the [ENTER] button to execute this Job.

05: Divide Drum Track

Separates the note events in a drum performance assigned to a specified Track, and places the notes corresponding to different drum instruments in separate Tracks (Tracks 1 through 8). After specifying a Track (TR 01 – 16) to which this Job is applied, press the [ENTER] button to execute this Job.

NOTE This job requires eight empty User Phrases in which to store the separated note data. If there aren't enough empty Phrases, an error message appears. If this happens, use the Clear Phrase Job ([page 109](#)) to delete some User Phrases, then try the Job again.

06: Put Track To Arp (Put Track to Arpeggio)

This Job copies data in the specified measures of a Section/Track for creating Arpeggio data. For details, see [page 126](#).

[F6] PATTERN (Pattern Job)

01: Copy Pattern

This Job copies all data from a selected source Pattern to a selected destination Pattern. After specifying the source Pattern/Section, and the destination Pattern/Section, as well as setting the checkboxes as necessary, press the [ENTER] button to execute this Job.

NOTE If you set the source Section to "all," the destination Section is also set to "all" automatically. In this status, execute this Job to copy the entire source Pattern data to the destination.

Source Pattern and Section Destination Pattern and Section

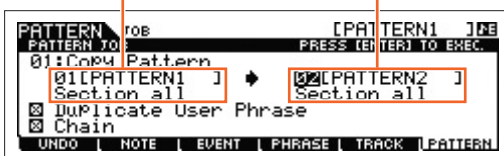

Duplicate User Phrase

When this box is checkmarked, User Phrases (if included in the source Pattern) are copied to another User Phrase, which will be assigned to the destination Pattern.

NOTE If the source Pattern number is same as the destination Pattern number, User Phrases are not copied to another User Phrase.

Chain

When this box is checkmarked, Pattern chain data (if included in the source Pattern) is copied to the destination Pattern.

Pattern Mode

Pattern Play

- [F1] PLAY
- [F2] GROOVE
- [F3] TRACK
- [F4] PATCH
- [F5] REMIX
- [F6] CHAIN

Pattern Record

Pattern Record Standby

- [F1] SETUP
- [F2] VOICE
- [F3] ARP ED
- [F5] CLICK

During Pattern Recording

- [F1] SETUP
- [F3] RESET
- [F4] TIE
- [F5] DELETE
- [F6] BAK DEL

Pattern Edit

- [F1] CHANGE
- [F2] VIEW FLT
- [F5] INSERT
- [F6] DELETE

Pattern Job

- [F1] UNDO/REDO
- [F2] NOTE
- [F3] EVENT
- [F4] PHRASE
- [F5] TRACK
- [F6] PATTERN

Supplementary Information

02: Append Pattern

Appends one Pattern to the end of another to create one longer Pattern with all 16 Tracks.

NOTE If the Pattern length becomes greater than 256 measures as a result of the Append Pattern Job, an error message will be displayed and the Job will be aborted.

Keep Original Phrase

When this box is checkmarked, the original destination Pattern data is retained in memory, along with the new appended Pattern data.

NOTE If the box is not checkmarked, the original destination Pattern is erased and replaced with the newly created data. When the "Keep Original Phrase" checkbox is checked, this job requires twice the number of empty User Phrases as the number of Tracks containing data in which to store the appended Phrase data. If the required space is not available, an alert message will appear and the Job will be aborted. If this occurs use the Clear Phrase Job to delete unused Phrases then try again.

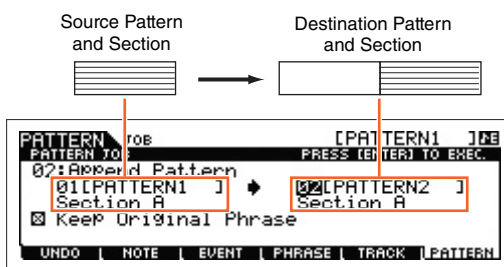

03: Split Pattern

This Job splits a selected Pattern (all 16 Tracks data) into two Patterns. After the Split Pattern operation, the part of the Pattern before the specified Split Point will remain, and the part following the "Split Point" will be moved to the destination Pattern.

NOTICE

This Job overwrites any data already existing in the destination Pattern.

Split Point

Determines the Split Point by setting a measure number.

Keep Original Phrase

When this box is checkmarked, the original Source Pattern data is retained in memory and the results of the Split Job are written to empty Phrases. When this box is not checkmarked, the original Source Pattern is erased and replaced with the newly created data.

NOTE When the "Keep Original Phrase" checkbox is checked, this Job requires twice the number of empty User Phrases as the number of Tracks containing data in which to store the appended Phrase data. If the required space is unavailable, an alert message will appear and the Job will be aborted. If this occurs use the Clear Phrase Job (page 109) to delete unused Phrases and try again.

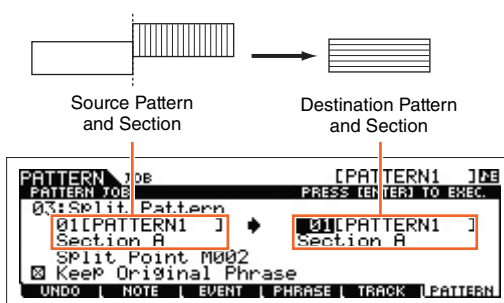

04: Clear Pattern

This Job deletes all data from the selected Pattern, or from all Patterns.

When the specific Section is selected to be cleared, you can unmark the "Chain" box. If the "Chain" box is not checkmarked, the Pattern Chain data will be kept even though the Clear Pattern Job is executed.

05: Pattern Name

This Job lets you assign a name to the selected Pattern. For detailed instructions on naming, see the "Basic Operation" of the Owner's Manual.

Pattern Mode

Pattern Play

- [F1] PLAY
- [F2] GROOVE
- [F3] TRACK
- [F4] PATCH
- [F5] REMIX
- [F6] CHAIN

Pattern Record

Pattern Record Standby

- [F1] SETUP
- [F2] VOICE
- [F3] ARP ED
- [F5] CLICK

During Pattern Recording

- [F1] SETUP
- [F3] RESET
- [F4] TIE
- [F5] DELETE
- [F6] BAK DEL

Pattern Edit

- [F1] CHANGE
- [F2] VIEW FLT
- [F5] INSERT
- [F6] DELETE

Pattern Job

- [F1] UNDO/REDO
- [F2] NOTE
- [F3] EVENT
- [F4] PHRASE
- [F5] TRACK
- [F6] PATTERN

Supplementary Information

Supplementary Information

■ Pattern Playback Types

Starting playback by pressing a note

When the Keyboard Start function is set to on, Pattern playback begins as soon as you press a key on the keyboard. Move the cursor to the Keyboard Start icon then press the [INC] button in the PLAY display of the Pattern Play to enable Keyboard Start. In this status, press any key to start Pattern playback.

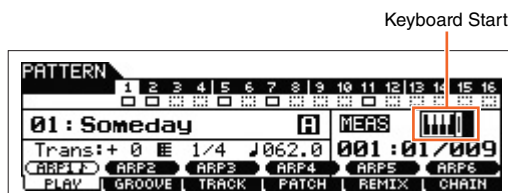

Changing the Section during playback

To change Sections during playback, press the [PATTERN SECTION] button (the lamp lights), then use the Number [1] – [16] buttons. When selecting a different Section during Pattern playback, “NT” and the next Section name appear in the Section column at the top of the display. After the current Section reaches the timing specified in “PtnQuantize” (page 144) in the [F2] SEQ display of the Utility mode, the next Section starts. If you record rhythm patterns such as intro, melody A, fill-in, main theme, and ending to each of the Sections, you can play an entire Song by selecting the appropriate Sections during playback.

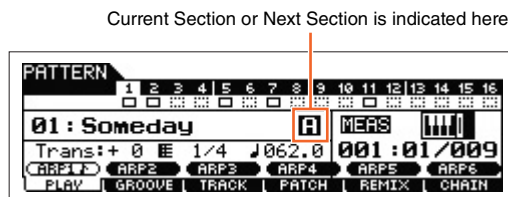

Pattern Chain Playback

The Pattern Chain function lets you program Sections in your own custom order, and have them change automatically during playback to create a seamless sequence of backing parts and accompaniment for your live performance or recorded Song. The Chain Play display (page 103) is the “portal” for entering the Pattern Chain function and lets you play back the programmed Pattern Chain. Press the [F6] CHAIN button from Pattern Play to go to the Pattern Chain Play display. Pattern Chains can be created from the Chain Record display (page 103) and the Insert function (page 104) in the Chain Edit display. Pattern Chains can be edited in the Chain Edit display (page 104).

Pattern Mode

Pattern Play

- [F1] PLAY
- [F2] GROOVE
- [F3] TRACK
- [F4] PATCH
- [F5] REMIX
- [F6] CHAIN

Pattern Record

Pattern Record Standby

- [F1] SETUP
- [F2] VOICE
- [F3] ARP ED
- [F5] CLICK

During Pattern Recording

- [F1] SETUP
- [F3] RESET
- [F4] TIE
- [F5] DELETE
- [F6] BAK DEL

Pattern Edit

- [F1] CHANGE
- [F2] VIEW FLT
- [F5] INSERT
- [F6] DELETE

Pattern Job

- [F1] UNDO/REDO
- [F2] NOTE
- [F3] EVENT
- [F4] PHRASE
- [F5] TRACK
- [F6] PATTERN

Supplementary Information

■ Loop Recording (Pattern)

Operation

[PATTERN] → [REC] → [F1] SETUP → “Loop” = “on”

Pattern repeats the rhythm pattern of several measures (1 to 256 measures) in a “loop,” and its recording is also done using loops. This method is used when recording a Pattern Phrase using the Overdub method.

When recording a rhythm of Bass Drum, Snare Drum, Hi-Hat cymbal in order:

Loop 1st round

Bass Drum

↓

Loop 2nd round

Snare Drum
Bass Drum

↓

Loop 3rd round

Hi-Hat
Snare Drum
Bass Drum

NOTE Loop Recording can only be used with Realtime recording.

Pattern Mode

Pattern Play

- [F1] PLAY
- [F2] GROOVE
- [F3] TRACK
- [F4] PATCH
- [F5] REMIX
- [F6] CHAIN

Pattern Record

Pattern Record Standby

- [F1] SETUP
- [F2] VOICE
- [F3] ARP ED
- [F5] CLICK

During Pattern Recording

- [F1] SETUP
- [F3] RESET
- [F4] TIE
- [F5] DELETE
- [F6] BAK DEL

Pattern Edit

- [F1] CHANGE
- [F2] VIEW FLT
- [F5] INSERT
- [F6] DELETE

Pattern Job

- [F1] UNDO/REDO
- [F2] NOTE
- [F3] EVENT
- [F4] PHRASE
- [F5] TRACK
- [F6] PATTERN

Supplementary Information

Mixing Mode

The settings of the tone generator block for Song/Pattern playback are collectively referred to as a Mixing. The Mixing mode lets you change the Voice and effect settings for each Part. This section explains each parameter in four types (Mixing Play, Mixing Edit, Mixing Job, and Mixing Voice Edit). Keep in mind that Pattern Mixing parameters are not actually part of the Pattern sequence data in each Track, but rather are settings for the tone generator, as it is played back by the Pattern data. As such, the Mixing parameter settings are not recorded to the Song/Pattern Tracks.

NOTICE

The settings in Mixing Play/Mixing Edit are stored as part of Song/Pattern data.

NOTE Parameter settings in Mixing Play and Mixing Edit can be stored as a template to internal Flash ROM, as well as being stored as part of a Song/Pattern. For details, see [page 126](#).

Mixing Play

The Mixing Play display will appear when pressing the [MIXING] button in the Song mode or Pattern mode. Here you can edit the Mixing parameters which are important for creating a Song/Pattern.

Operation

[SONG]/[PATTERN] → Song/Pattern selection → [MIXING]

[F1] VOL/PAN (Volume/Pan)

PAN Knob

Determines the stereo pan position for each part.

Settings: L63 (far left) – C (center) – R63 (far right)

VOLUME Knob

Determines the volume for each Part allowing you to set the optimum level balance of all the Parts.

Settings: 0 – 127

[F2] VOICE

VOICENUM (Voice Number)

BANK MSB/LSB (Bank Select MSB/LSB)

Determines the Voice for each Part. Mixing Voices can also be selected.

NOTE The Category Search function can also be used to select Voices here, except for Mixing Voices.

P.WithVce (Parameter with Voice)

Determines whether or not the following parameter settings of the selected Voice are copied from the Voice to the current Part when you change a Voice for the current Part individually.

- Arpeggio settings
- Filter Cutoff Frequency
- Filter Resonance
- Amplitude EG
- Filter EG
- Pitch Bend Range (Upper/Lower)
- Note Shift

NOTE Regardless of the “P.WithVce” setting, the following settings are always copied when a Normal Voice is selected: “Mono/Poly,” “Switch” (Portamento Part Switch), “Time” (Portamento Time) and “Mode” (Portamento Mode).

Settings: off (not copied), on (copied)

Mixing Mode

Mixing Play

- ▶ [F1] VOL/PAN
- ▶ [F2] VOICE
- [F3] EF SEND
- [F4] TEMPLATE
- [F5] VCE ED
- [F6] EFFECT

Mixing Edit

Common Edit

- [F1] GENERAL
- [F2] MFX
- [F3] MEQ
- [F4] USB I/O
- [F5] A/D IN
- [F6] EFFECT

Part Edit

- [F1] VOICE
- [F2] OUTPUT
- [F3] EQ
- [F4] TONE
- [F5] RCV SW

Mixing Job

- [F1] INIT
- [F2] RECALL
- [F3] COPY
- [F4] BULK

Mixing Voice Edit

Common Edit

- [F1] GENERAL
- [F2] OUTPUT
- [F4] CTL SET
- [F5] LFO
- [F6] EFFECT

Element Edit

- [F1] OSC
- [F2] PITCH
- [F3] FILTER
- [F4] AMP
- [F5] LFO
- [F6] EQ

Mixing Voice Job

- [F2] RECALL
- [F3] COPY
- [F5] DELETE

Supplementary Information

[F3] EF SEND (Effect Send)

From this display you can make basic effect settings for each Part—including Send Level for the System Effects (Chorus, Reverb,) as well as the Dry Level for Insertion Effects.

NOTE For information on the effect connections in the Song mode, see [page 20](#).

[F4] TEMPLATE

[SF1] MIX (Mixing)

From this display you can copy the Mixing Template to the Mixing settings of currently edited Part. After selecting a desired Template, press the [ENTER] button to execute the Copy operation.

NOTE In addition to the Mixing settings, the tempo setting stored in the Mixing Template will also be automatically loaded.

NOTE For instruction on storing the Mixing settings as a Mixing Template, see [page 126](#).

[SF2] PERFORM (Performance)

This convenient operation lets you copy certain settings of the each Part in a performance to the Mixing program currently being edited. Press the [ENTER] button to execute the Copy operation.

NOTE This display is similar to the [SF3] PERFORM display in Mixing Job ([page 121](#)). However, this differs from the [SF3] PERFORM display in two major points:

- All parameters are copied simultaneously.
- The Receive Channel settings are assigned to the destination automatically.

NOTE For those Parts which Part Switch is set to OFF, Receive Channel is also set to OFF.

NOTE In addition to the Part settings, the Arpeggio tempo setting stored in the Performance will also be copied.

[F5] VCE ED (Mixing Voice Edit)

Press the [F5] VCE ED button in Mixing Play to enter Mixing Voice Edit. Press the [EXIT] button to return to the original display. Normal Voices can be edited specifically for use with the Song/Pattern modes, creating a dedicated “Mixing Voice.” For details, see the “Mixing Voice Edit” on [page 122](#).

[F6] EFFECT

Pressing the [F3] EFFECT button in the Mixing mode calls up the [SONG]/[PATTERN] → [MIXING] → [EDIT] → [COMMON] → [F6] EFFECT display in Mixing Edit. From this display, you can set the Effect related parameters for the current Song/Pattern. For details, see [page 116](#).

Mixing Mode

Mixing Play

[F1] VOL/PAN

[F2] VOICE

▶ [F3] EF SEND

▶ [F4] TEMPLATE

▶ [F5] VCE ED

▶ [F6] EFFECT

Mixing Edit

Common Edit

[F1] GENERAL

[F2] MFX

[F3] MEQ

[F4] USB I/O

[F5] A/D IN

[F6] EFFECT

Part Edit

[F1] VOICE

[F2] OUTPUT

[F3] EQ

[F4] TONE

[F5] RCV SW

Mixing Job

[F1] INIT

[F2] RECALL

[F3] COPY

[F4] BULK

Mixing Voice Edit

Common Edit

[F1] GENERAL

[F2] OUTPUT

[F4] CTL SET

[F5] LFO

[F6] EFFECT

Element Edit

[F1] OSC

[F2] PITCH

[F3] FILTER

[F4] AMP

[F5] LFO

[F6] EQ

Mixing Voice Job

[F2] RECALL

[F3] COPY

[F5] DELETE

Supplementary Information

Mixing Edit

The Mixing Edit mode lets you control typical mixer settings such as volume balance, pan position and effects, allowing you to fine tune the Song/Pattern data. Mixing Edit consists of Part Edit and Common Edit. This section explains the parameters for Common Edit and Part Edit.

Common Edit

Operation

[SONG]/[PATTERN] → Song/Pattern selection → [MIXING] → [EDIT] → [COMMON]

[F1] GENERAL

A.Func1 (Assignable Function 1)

A.Func2 (Assignable Function 2)

Determines whether the ASSIGNABLE FUNCTION [1] and [2] buttons function as latch (hold) type or momentary type in the selected Song/Pattern.

Settings: momentary, latch

[F2] MFX (Master Effect)

From this display you can set the Master Effect related parameters. The parameters are the same as in Performance Common Edit ([page 60](#)).

[F3] MEQ (Master EQ)

From this display you can set parameters related to the Master Equalizer. You can assign any of five different Equalizer bands to the entire Multi. The parameters are the same as in Performance Common Edit ([page 61](#)).

[F4] USB I/O

Determines the specific output(s) for the individual Part signal. The parameters are the same as in Performance Common Edit ([page 61](#)).

[F5] A/D IN (A/D Input)

This display sets parameters related to the input from the A/D INPUT [L]/[R] jacks. The parameters are the same as in Performance Common Edit ([page 62](#)).

[F6] EFFECT

From this display you can set the Effect related parameters. The parameters are the same as in Performance Common Edit ([page 63](#)).

Mixing Mode

Mixing Play

[F1] VOL/PAN

[F2] VOICE

[F3] EF SEND

[F4] TEMPLATE

[F5] VCE ED

[F6] EFFECT

Mixing Edit

Common Edit

▶ [F1] GENERAL

▶ [F2] MFX

▶ [F3] MEQ

▶ [F4] USB I/O

▶ [F5] A/D IN

▶ [F6] EFFECT

Part Edit

[F1] VOICE

[F2] OUTPUT

[F3] EQ

[F4] TONE

[F5] RCV SW

Mixing Job

[F1] INIT

[F2] RECALL

[F3] COPY

[F4] BULK

Mixing Voice Edit

Common Edit

[F1] GENERAL

[F2] OUTPUT

[F4] CTL SET

[F5] LFO

[F6] EFFECT

Element Edit

[F1] OSC

[F2] PITCH

[F3] FILTER

[F4] AMP

[F5] LFO

[F6] EQ

Mixing Voice Job

[F2] RECALL

[F3] COPY

[F5] DELETE

Supplementary Information

Part Edit

Operation

[SONG]/[PATTERN] → Song/Pattern selection → [MIXING] → [EDIT] → Number [1] – [16]

[F1] VOICE

Determines the Voice for each Part. This display shows only four Parts at a time (Part 1 – 4, Part 5 – 8, Part 9 – 12, or Part 13 – 16). To switch the editable Parts, press the Cursor [<]/[>] buttons. The editable Parts can be also switched by pressing the corresponding buttons to other Parts of numbers [1] – [16] after pressing the [TRACK] button.

[SF1] VOICE

Determines the Voice for each Part.

Bank

Determines the Voice Bank for each Part. For information about settings other than those of the Mixing Voices, see [page 7](#).

Number

Determines the Voice Program number for each Part.

P.WithVce (Parameter with Voice)

Determines whether or not the following parameter settings of the selected Voice are copied from the Voice to the current Part when you change a Voice for the current Part individually.

- Arpeggio settings
- Filter Cutoff Frequency
- Filter Resonance
- Amplitude EG
- Filter EG
- Pitch Bend Range (Upper/Lower)
- Note Shift

NOTE When a Normal Voice is assigned to the Part, the following settings are always copied to the Part regardless of the "P.WithVce" setting. On the other hand, when a Drum Voice is assigned to the part, the following settings are not copied to the part regardless of the "P.WithVce" setting.

- "Mono/Poly"
- "Switch" (Portamento Part Switch)
- "Time" (Portamento Time)
- "Mode" (Portamento Mode)

Settings: off (not copied), on (copied)

[SF2] MODE

Mono/Poly

Selects monophonic or polyphonic playback for each Part. Monophonic is for single notes only, while polyphonic is for playing multiple simultaneous notes.

Settings: mono, poly

NOTE This parameter is not available for the Parts to which Drum Voices have been assigned.

ReceiveCh (Receive Channel)

Determines the MIDI receive channel for the selected Part. Since MIDI data may be coming from many channels at once, you should set this to match the particular channel over which the desired controlling data is being sent.

Settings: 1 – 16, off

ArpPlyOnly (Arpeggio Play Only)

Determines whether or not the current Part plays only the note events of Arpeggio playback. When this parameter is set to on, only the note events of Arpeggio playback affect the tone generator block.

Settings: off, on

Mixing Mode

Mixing Play

- [F1] VOL/PAN
- [F2] VOICE
- [F3] EF SEND
- [F4] TEMPLATE
- [F5] VCE ED
- [F6] EFFECT

Mixing Edit

Common Edit

- [F1] GENERAL
- [F2] MFX
- [F3] MEQ
- [F4] USB I/O
- [F5] A/D IN
- [F6] EFFECT

Part Edit

- ▶ [F1] VOICE
- [F2] OUTPUT
- [F3] EQ
- [F4] TONE
- [F5] RCV SW

Mixing Job

- [F1] INIT
- [F2] RECALL
- [F3] COPY
- [F4] BULK

Mixing Voice Edit

Common Edit

- [F1] GENERAL
- [F2] OUTPUT
- [F4] CTL SET
- [F5] LFO
- [F6] EFFECT

Element Edit

- [F1] OSC
- [F2] PITCH
- [F3] FILTER
- [F4] AMP
- [F5] LFO
- [F6] EQ

Mixing Voice Job

- [F2] RECALL
- [F3] COPY
- [F5] DELETE

Supplementary Information

[SF3] LIMIT

From this display you can determine the note range and velocity range for each Part. The parameters are the same as in Performance Part Edit. See [page 65](#).

[SF4] PORTA (Portamento)

Determines the Portamento parameters for each Part. The parameters are the same as in Performance Part Edit. See [page 65](#).

[SF5] VEL SENS (Velocity Sensitivity)

The parameters are the same as in Performance Part Edit. See [page 65](#).

[SF6] OTHER

The parameters are the same as in Performance Part Edit. See [page 66](#).

[F2] OUTPUT

Determines the Voice for each Part. This display shows only four Parts at a time (Part 1 – 4, Part 5 – 8, Part 9 – 12, or Part 13 – 16). To switch the editable Parts, press the Cursor [<]/[>] buttons. The editable Parts can be also switched by pressing the corresponding buttons to other Parts of numbers [1] – [16] after pressing the [TRACK] button.

[SF1] VOL/PAN (Volume/Pan)

The parameters are the same as in Performance Part Edit. See [page 66](#).

[SF2] EF SEND (Effect Send)

The parameters are the same as in Performance Part Edit. See [page 66](#).

[F3] EQ (Equalizer)

From this display you can set parameters related to the Part EQ. The parameters are the same as in Performance Part Edit. See [page 67](#).

[F4] TONE**[SF1] TUNE**

The parameters are the same as in Performance Part Edit. See [page 68](#).

[SF2] FILTER

The parameters are the same as in Performance Part Edit. See [page 68](#).

[SF3] FEG (Filter EG)

From this display you can set the FEG parameters for each Part. The parameters offset the same parameters of the assigned Voice set in the Voice mode ([page 42](#)). The parameters are the same as in Performance Part Edit. See [page 68](#).

NOTE These FEG parameters are not available for the Parts to which Drum Voices have been assigned.

Mixing Mode**Mixing Play**

- [F1] VOL/PAN
- [F2] VOICE
- [F3] EF SEND
- [F4] TEMPLATE
- [F5] VCE ED
- [F6] EFFECT

Mixing Edit**Common Edit**

- [F1] GENERAL
- [F2] MFX
- [F3] MEQ
- [F4] USB I/O
- [F5] A/D IN
- [F6] EFFECT

Part Edit

- ▶ [F1] VOICE
- ▶ [F2] OUTPUT
- ▶ [F3] EQ
- ▶ [F4] TONE
- [F5] RCV SW

Mixing Job

- [F1] INIT
- [F2] RECALL
- [F3] COPY
- [F4] BULK

Mixing Voice Edit**Common Edit**

- [F1] GENERAL
- [F2] OUTPUT
- [F4] CTL SET
- [F5] LFO
- [F6] EFFECT

Element Edit

- [F1] OSC
- [F2] PITCH
- [F3] FILTER
- [F4] AMP
- [F5] LFO
- [F6] EQ

Mixing Voice Job

- [F2] RECALL
- [F3] COPY
- [F5] DELETE

Supplementary Information

[SF4] AEG (Amplitude EG)

From this display you can set the AEG parameters for each Part. The parameters offset the same parameters of the assigned Voice set in the Voice mode (page 44). The parameters are the same as in Performance Part Edit. See page 68.

NOTE The Sustain setting is not available for Parts to which Drum Voices have been assigned.

NOTE The Release setting is not available for Parts to which Drum Voices have been assigned.

[F5] RCV SW (Receive Switch)

From this display you can set how each individual Part responds to various MIDI data, such as Control Change and Program Change messages. When the relevant parameter is set to “on,” the corresponding Part responds to the appropriate MIDI data. Note that two different display types listed below are provided and you can switch between them by pressing the [SF5] button. The two display types are linked and feature the same settings, only in different formats. Use the type you feel most comfortable with.

Display showing four Parts

This display type shows the Receive Switch status for four Parts at a time. Set the desired Part on or off, for the corresponding MIDI data type. To view and edit another set of four Parts, press the appropriate Number button, [1] to [16].

Display showing all parameters for one Part

This display type shows all of the Receive Switch settings for a single selected Part. Set the desired MIDI data type on or off for the selected Part. To select other Parts, use the Number [1] – [16] buttons (making sure that the [TRACK] button is on). The function is the same as the one in the RCV SW display (page 69) in the Performance Part Edit mode. In addition to the parameters which can be set in the Performance Part Edit mode, Program Change and Bank Select can be set in this display of the Mixing mode.

Mixing Mode

Mixing Play

- [F1] VOL/PAN
- [F2] VOICE
- [F3] EF SEND
- [F4] TEMPLATE
- [F5] VCE ED
- [F6] EFFECT

Mixing Edit

Common Edit

- [F1] GENERAL
- [F2] MFX
- [F3] MEQ
- [F4] USB I/O
- [F5] A/D IN
- [F6] EFFECT

Part Edit

- [F1] VOICE
- [F2] OUTPUT
- [F3] EQ
- ▶ [F4] TONE
- ▶ [F5] RCV SW

Mixing Job

- [F1] INIT
- [F2] RECALL
- [F3] COPY
- [F4] BULK

Mixing Voice Edit

Common Edit

- [F1] GENERAL
- [F2] OUTPUT
- [F4] CTL SET
- [F5] LFO
- [F6] EFFECT

Element Edit

- [F1] OSC
- [F2] PITCH
- [F3] FILTER
- [F4] AMP
- [F5] LFO
- [F6] EQ

Mixing Voice Job

- [F2] RECALL
- [F3] COPY
- [F5] DELETE

Supplementary Information

Mixing Job

The Performance Job features several basic operations, such as Initialize and Copy. After setting parameters as required in the selected display, press the [ENTER] button to execute the Job.

Operation

[SONG]/[PATTERN] → Song/Pattern selection → [MIXING] → [JOB]

[F1] INIT (Initialize)

Resets (initializes) all Mixing parameters to their default settings. It also allows you to selectively initialize certain parameters, such as Common settings, settings for each Part, and so on—very useful when creating a completely new Performance from scratch.

Type of parameter to be initialized:

GM, All, Common (Common parameter settings for the selected Mixing), Part 1 – 16, A/D (A/D input part)

[F2] RECALL (Edit Recall)

If you are editing a Mixing program and select a different program without storing your edited one, all the edits you've made will be erased. If this happens, you can use Edit Recall to restore the Mixing program with your latest edits intact.

[F3] COPY

[SF1] PART

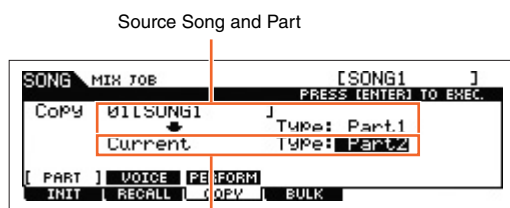

Destination Song (current Song) and Part

From this display you can copy Part parameter settings from any Mixing program including the currently edited (but not yet stored) one to a particular Part of the Mixing program you are editing. This would come in handy when you want to use some settings from another program. The procedure is basically the same as in the [F3] COPY display in the Performance Job. See [page 70](#).

[SF2] VOICE

This Job lets you copy the settings of the Voice Common Edit to the current Mixing. This would come in handy when a certain Voice has effect settings that you want to use in your Mixing program. You can check the appropriate check boxes for the desired settings of the Reverb Effect, Chorus Effect, Master Effect, and Master EQ to execute this job.

NOTE Mixing Voices cannot be selected as source Voices.

Mixing Mode

Mixing Play

- [F1] VOL/PAN
- [F2] VOICE
- [F3] EF SEND
- [F4] TEMPLATE
- [F5] VCE ED
- [F6] EFFECT

Mixing Edit

Common Edit

- [F1] GENERAL
- [F2] MFX
- [F3] MEQ
- [F4] USB I/O
- [F5] A/D IN
- [F6] EFFECT

Part Edit

- [F1] VOICE
- [F2] OUTPUT
- [F3] EQ
- [F4] TONE
- [F5] RCV SW

Mixing Job

- ▶ [F1] INIT
- ▶ [F2] RECALL
- ▶ [F3] COPY
- [F4] BULK

Mixing Voice Edit

Common Edit

- [F1] GENERAL
- [F2] OUTPUT
- [F4] CTL SET
- [F5] LFO
- [F6] EFFECT

Element Edit

- [F1] OSC
- [F2] PITCH
- [F3] FILTER
- [F4] AMP
- [F5] LFO
- [F6] EQ

Mixing Voice Job

- [F2] RECALL
- [F3] COPY
- [F5] DELETE

Supplementary Information

[SF3] PERFORM (Performance)

This convenient operation lets you copy certain settings of the four Parts in a performance to the Mixing program currently being edited. You can check the appropriate check boxes for the desired settings of the Reverb Effect, Chorus Effect, Master Effect, Master EQ, Insertion Effect, and A/D input part to execute this job. This would come in handy when a certain Performance has settings that you want to use in your Mixing program. This is similar to [F4] TEMPLATE → [SF2] PERFORM display (page 115) in the Mixing Play, but differs in that the move-source data will be deleted.

- In this display, you can select the parameters that will be copied.
- The “ReceiveCh” set to the destination Part of the Song/Pattern varies depending on the destination Part. The settings are as follows.
 - Parts 1 – 4: Channel 1
 - Parts 5 – 8: Channel 5
 - Parts 9 – 12: Channel 9
 - Parts 13 – 16: Channel 13

[F4] BULK (Bulk Dump)

This function lets you send all your edited parameter settings for the currently selected Mixing program to a computer or another MIDI device for data archiving. Press the [ENTER] button to execute Bulk Dump.

NOTE In order to execute Bulk Dump, you will need to set the correct MIDI Device Number. For details, see page 148.

Mixing Mode

Mixing Play

- [F1] VOL/PAN
- [F2] VOICE
- [F3] EF SEND
- [F4] TEMPLATE
- [F5] VCE ED
- [F6] EFFECT

Mixing Edit

Common Edit

- [F1] GENERAL
- [F2] MFX
- [F3] MEQ
- [F4] USB I/O
- [F5] A/D IN
- [F6] EFFECT

Part Edit

- [F1] VOICE
- [F2] OUTPUT
- [F3] EQ
- [F4] TONE
- [F5] RCV SW

Mixing Job

- [F1] INIT
- [F2] RECALL
- ▶ [F3] COPY
- ▶ [F4] BULK

Mixing Voice Edit

Common Edit

- [F1] GENERAL
- [F2] OUTPUT
- [F4] CTL SET
- [F5] LFO
- [F6] EFFECT

Element Edit

- [F1] OSC
- [F2] PITCH
- [F3] FILTER
- [F4] AMP
- [F5] LFO
- [F6] EQ

Mixing Voice Job

- [F2] RECALL
- [F3] COPY
- [F5] DELETE

Supplementary Information

Mixing Voice Edit

In this mode, you can edit the Voices assigned to Mixing Parts 1 – 16 respectively and store them as Mixing Voices. The Mixing Voice Edit settings are applied only to Normal Voices. When a Normal Voice is selected, the Voice Edit parameters are divided into Common Edit (parameters common to all four Elements), and Element Edit (parameters of individual Elements). Mixing Voice Jobs are also available, providing convenient tools for organizing your created Mixing Voices. This section explains each parameter in three types (Common Edit, Element Edit, and Mixing Voice Job).

NOTE For more information about Mixing Voices, see [page 7](#).

Common Edit

Operation

[SONG]/[PATTERN] → [MIXING] → [F2] VOICE → Normal Voice selection → [F5] VCE ED → [COMMON]

Same as in Normal Voice Common Edit ([page 30](#)). The Mixing Voice Edit parameters are basically the same as those in the Voice Edit mode. However, some parameters having the same name as those in Song Mixing/Pattern Mixing Part Edit are not available in Mixing Voice Edit.

[F1] GENERAL

Same as in Normal Voice Common Edit ([page 30](#)). Please note that the [F3] EQ display is not available in Mixing Voice Edit.

[F2] OUTPUT

Same as in Normal Voice Common Edit ([page 31](#)).

[F4] CTL SET (Controller Set)

Same as in Normal Voice Common Edit ([page 32](#)).

[F5] LFO (Low Frequency Oscillator)

Same as in Normal Voice Common Edit ([page 33](#)).

[F6] EFFECT

Same as in Normal Voice Common Edit. See [page 35](#). However, please note that the [SF4] REVERB and [SF5] CHORUS displays are not available in Mixing Voice Edit.

NOTE When selecting the Part for which the Insertion Effect switch is set to off, the [F6] EFFECT display is not available.

Element Edit

Operation

[SONG]/[PATTERN] → [MIXING] → [F2] VOICE → Normal Voice selection → [F5] VCE ED → Element selection

[F1] OSC (Oscillator)

Same as in Normal Voice Element Edit ([page 38](#)).

Mixing Mode

Mixing Play

- [F1] VOL/PAN
- [F2] VOICE
- [F3] EF SEND
- [F4] TEMPLATE
- [F5] VCE ED
- [F6] EFFECT

Mixing Edit

Common Edit

- [F1] GENERAL
- [F2] MFX
- [F3] MEQ
- [F4] USB I/O
- [F5] A/D IN
- [F6] EFFECT

Part Edit

- [F1] VOICE
- [F2] OUTPUT
- [F3] EQ
- [F4] TONE
- [F5] RCV SW

Mixing Job

- [F1] INIT
- [F2] RECALL
- [F3] COPY
- [F4] BULK

Mixing Voice Edit

Common Edit

- ▶ [F1] GENERAL
- ▶ [F2] OUTPUT
- ▶ [F4] CTL SET
- ▶ [F5] LFO
- ▶ [F6] EFFECT

Element Edit

- ▶ [F1] OSC
- [F2] PITCH
- [F3] FILTER
- [F4] AMP
- [F5] LFO
- [F6] EQ

Mixing Voice Job

- [F2] RECALL
- [F3] COPY
- [F5] DELETE

Supplementary Information

[F2] PITCH

Same as in Normal Voice Element Edit (page 40).

[F3] FILTER

Same as in Normal Voice Element Edit (page 41).

[F4] AMP (Amplitude)

Same as in Normal Voice Element Edit (page 43).

[F5] LFO (Low Frequency Oscillator)

Same as in Normal Voice Element Edit (page 45).

[F6] EQ (Equalizer)

Same as in Normal Voice Element Edit (page 46).

Mixing Voice Job

The Mixing Voice Job mode features two basic operations, Copy and Delete. After setting parameters as required in the selected display, press the [ENTER] button to execute the Job.

[F2] RECALL (Edit Recall)

If you are editing a Mixing Voice and select a different Mixing Voice, Mixing program, Song or Pattern without storing your edited one, all the edits you've made will be erased. Edits are also erased if the current Part to which the edited Mixing Voice is assigned receives a program change from an external MIDI instrument. If this happens, you can use Edit Recall to restore the Mixing Voice with your latest edits intact by pressing the [ENTER] button from the [F2] RECALL display.

NOTE Since a Recall Buffer for the Mixing Voice is prepared for each Part of the current Song or Pattern, you can specify the Part to which the Mixing Voice to be recalled is assigned before executing Edit Recall.

[F3] COPY

This Job lets you copy the Mixing Voice stored to a specified Part in one Song/Pattern to a Part in another Song/Pattern.

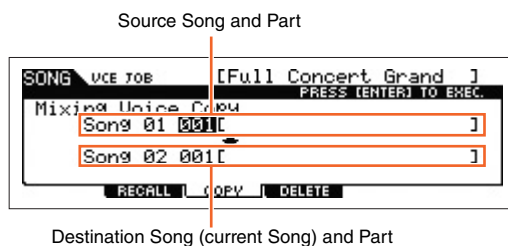
**[F5] DELETE**

This Job lets you delete a Mixing Voice assigned to a specified Song/Pattern's Part.

Mixing Mode**Mixing Play**

- [F1] VOL/PAN
- [F2] VOICE
- [F3] EF SEND
- [F4] TEMPLATE
- [F5] VCE ED
- [F6] EFFECT

Mixing Edit**Common Edit**

- [F1] GENERAL
- [F2] MFX
- [F3] MEQ
- [F4] USB I/O
- [F5] A/D IN
- [F6] EFFECT

Part Edit

- [F1] VOICE
- [F2] OUTPUT
- [F3] EQ
- [F4] TONE
- [F5] RCV SW

Mixing Job

- [F1] INIT
- [F2] RECALL
- [F3] COPY
- [F4] BULK

Mixing Voice Edit**Common Edit**

- [F1] GENERAL
- [F2] OUTPUT
- [F4] CTL SET
- [F5] LFO
- [F6] EFFECT

Element Edit

- [F1] OSC
- [F2] PITCH
- [F3] FILTER
- [F4] AMP
- [F5] LFO
- [F6] EQ

Mixing Voice Job

- [F2] RECALL
- [F3] COPY
- [F5] DELETE

Supplementary Information

Supplementary Information

■ Editing a Performance by using the Knobs

By using the knobs on the front panel, you can adjust various parameters such as pan, effect, cutoff frequency and resonance for each Part (Track) of the Mixing.

1 Press one of the Knob Function buttons (1 or 2) to call up the Control Function display.

2 Select the Part you want to edit.

Press a number button corresponding to the Part number.

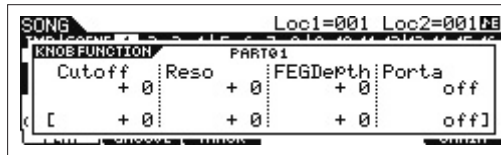

3 Select the functions assigned to Knobs 1 – 4 or Knobs 5 – 8.

Each time Knob Function 1 button is pressed, the lamp lights alternatively in descending order, [TONE1] | [TONE2] | [TONE3]. The functions assigned to Knobs 1 – 4 will be switched according to the operation of Knob Function 1 button. Each time Knob Function 2 button is pressed, the lamp lights alternatively in descending order, [EQ] | [EFFECT] | [ARP]. The functions assigned to Knobs 5 – 8 will be switched according to the operation of Knob Function 2 button. When each lamp is turned on, the functions assigned to the Knobs are as follows.

When the [TONE 1] lamp is turned on:

Knob 1	CUTOFF	[SONG] or [PATTERN] → Song/Pattern selection → [MIXING] → [EDIT] → Part selection → [F4] TONE → [SF2] FILTER → "Cutoff"	page 118
Knob 2	RESONANCE	[SONG] or [PATTERN] → Song/Pattern selection → [MIXING] → [EDIT] → Part selection → [F4] TONE → [SF2] FILTER → "Resonance"	
Knob 3	FEG DEPTH	[SONG] or [PATTERN] → Song/Pattern selection → [MIXING] → [EDIT] → Part selection → [F4] TONE → [SF2] FILTER → "FEGDepth"	
Knob 4	PORTAMENTO	[SONG] or [PATTERN] → Song/Pattern selection → [MIXING] → [EDIT] → Part selection → [F1] VOICE → [SF4] PORTA → "Time"	page 118

When the [TONE 2] lamp is turned on:

Knob 1	ATTACK	[SONG] or [PATTERN] → Song/Pattern selection → [MIXING] → [EDIT] → Part selection → [F4] TONE → [SF4] AEG → "Attack"	page 119
Knob 2	DECAY	[SONG] or [PATTERN] → Song/Pattern selection → [MIXING] → [EDIT] → Part selection → [F4] TONE → [SF4] AEG → "Decay"	
Knob 3	SUSTAIN	[SONG] or [PATTERN] → Song/Pattern selection → [MIXING] → [EDIT] → Part selection → [F4] TONE → [SF4] AEG → "Sustain"	
Knob 4	RELEASE	[SONG] or [PATTERN] → Song/Pattern selection → [MIXING] → [EDIT] → Part selection → [F4] TONE → [SF4] AEG → "Release"	

When the [TONE 3] lamp is turned on:

Knob 1	VOLUME	[SONG] → Song selection → [MIXING] → [EDIT] → Part selection → [F2] OUTPUT → [SF1] VOL/PAN → "Volume"	page 118
Knob 2	PAN	[SONG] or [PATTERN] → Song/Pattern selection → [MIXING] → [EDIT] → Part selection → [F2] OUTPUT → [SF1] VOL/PAN → "Pan"	
Knob 3	ASSIGN 1	[SONG] or [PATTERN] → Song/Pattern selection → [MIXING] → [EDIT] → Part selection → [F1] VOICE → [SF6] OTHER → "Assign 1"	page 118
Knob 4	ASSIGN 2	[SONG] or [PATTERN] → Song/Pattern selection → [MIXING] → [EDIT] → Part selection → [F1] VOICE → [SF6] OTHER → "Assign 2"	

When the [EQ] lamp is turned on:

Knob 5	LOW	[SONG] / [PATTERN] → Song/Pattern selection → [MIXING] → [EDIT] → Part selection → [F3] EQ → "LOW GAIN"	page 118
Knob 6	MID F	[SONG] / [PATTERN] → Song/Pattern selection → [MIXING] → [EDIT] → Part selection → [F3] EQ → "MID FREQ"	
Knob 7	MID	[SONG] / [PATTERN] → Song/Pattern selection → [MIXING] → [EDIT] → Part selection → [F3] EQ → "MID GAIN"	
Knob 8	HIGH	[SONG] / [PATTERN] → Song/Pattern selection → [MIXING] → [EDIT] → Part selection → [F3] EQ → "HIGH GAIN"	

Mixing Mode

Mixing Play

- [F1] VOL/PAN
- [F2] VOICE
- [F3] EF SEND
- [F4] TEMPLATE
- [F5] VCE ED
- [F6] EFFECT

Mixing Edit

Common Edit

- [F1] GENERAL
- [F2] MFX
- [F3] MEQ
- [F4] USB I/O
- [F5] A/D IN
- [F6] EFFECT

Part Edit

- [F1] VOICE
- [F2] OUTPUT
- [F3] EQ
- [F4] TONE
- [F5] RCV SW

Mixing Job

- [F1] INIT
- [F2] RECALL
- [F3] COPY
- [F4] BULK

Mixing Voice Edit

Common Edit

- [F1] GENERAL
- [F2] OUTPUT
- [F4] CTL SET
- [F5] LFO
- [F6] EFFECT

Element Edit

- [F1] OSC
- [F2] PITCH
- [F3] FILTER
- [F4] AMP
- [F5] LFO
- [F6] EQ

Mixing Voice Job

- [F2] RECALL
- [F3] COPY
- [F5] DELETE

Supplementary Information

When the [EFFECT] lamp is turned on:

Knob 5	CHO PRESET	[SONG]/[PATTERN] → Song/Pattern selection → [MIXING] → [EDIT] → [COMMON] → [F6] EFFECT → [SF4] CHORUS → "Preset"	page 116
Knob 6	CHO SEND	[SONG]/[PATTERN] → Song/Pattern selection → [MIXING] → [F3] EF SEND → part selection → "CHO SEND"	
Knob 7	REV PRESET	[SONG]/[PATTERN] → Song/Pattern selection → [MIXING] → [EDIT] → [COMMON] → [F6] EFFECT → [SF4] CHORUS → "Preset"	
Knob 8	REV SEND	[SONG]/[PATTERN] → Song/Pattern selection → [MIXING] → [F3] EF SEND → part selection → "REV SEND"	

When the [ARP] lamp is turned on:

Knob 5	GATE TIME	[SONG]/[PATTERN] → Song/Pattern selection → ARP [EDIT] → [F5] PLAY FX → part selection → "GateTimeRate" in the first page	page 83
Knob 6	OCT RANGE	[SONG]/[PATTERN] → Song/Pattern selection → ARP [EDIT] → [F5] PLAY FX → part selection → "OctaveRange" in the first page	
Knob 7	UNITMULTIPLY	[SONG]/[PATTERN] → Song/Pattern selection → ARP [EDIT] → [F5] PLAY FX → part selection → "UnitMultiply" in the first page	
Knob 8	TEMPO	[SONG]/[PATTERN] → Song/Pattern selection → ♪ (Tempo)	

NOTE Holding the [SHIFT] button and pressing the Knob Function 1 or 2 button will light the TONE/EQ lamp.

■ Creating an Arpeggio

In addition to using the preset Arpeggios, you can also create your own original Arpeggio data. First, record a Phrase to a Song or Pattern Track. Then, use the appropriate Song or Pattern Job function to convert the data (MIDI sequence data) to Arpeggio data.

- 1 Record MIDI sequence data to a Song or Pattern.**
- 2 Convert the MIDI sequence data (recorded to the Song or Pattern) to Arpeggio data.**

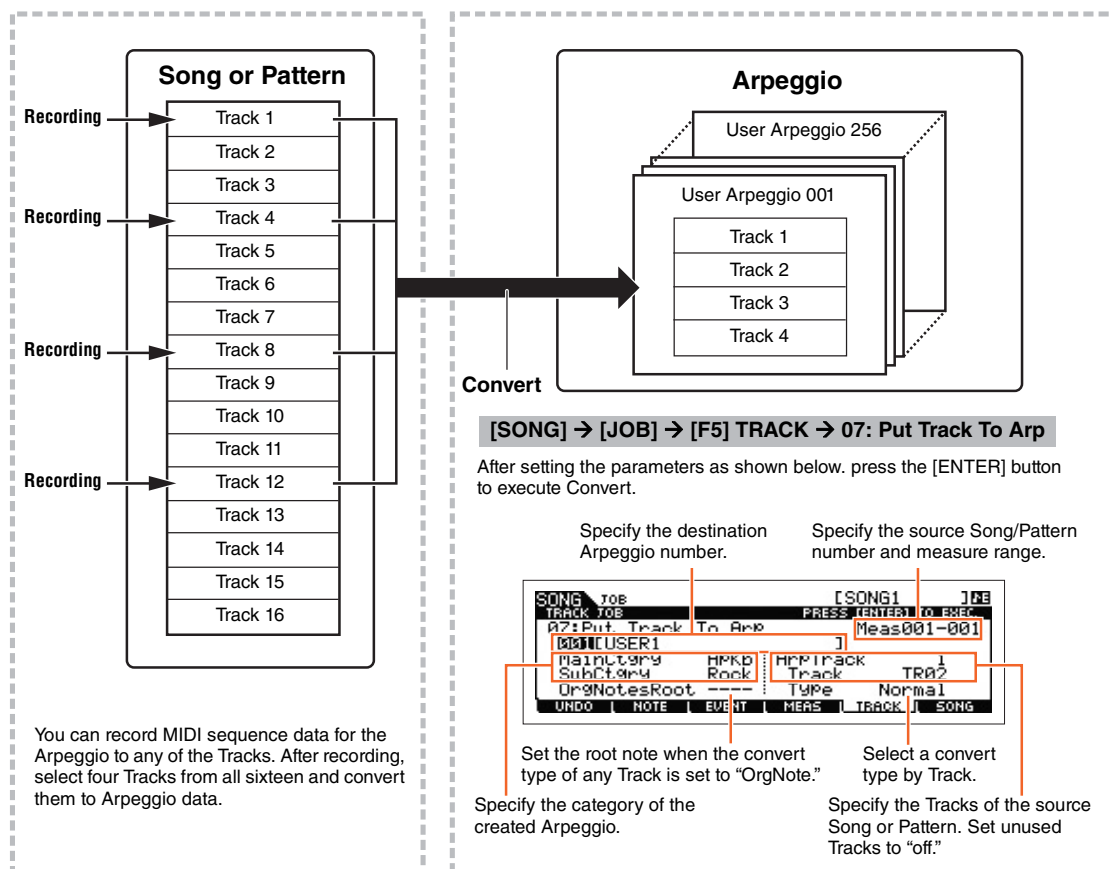

Mixing Mode

Mixing Play

[F1] VOL/PAN
[F2] VOICE
[F3] EF SEND
[F4] TEMPLATE
[F5] VCE ED
[F6] EFFECT

Mixing Edit

Common Edit

[F1] GENERAL
[F2] MFX
[F3] MEQ
[F4] USB I/O
[F5] A/D IN
[F6] EFFECT

Part Edit

[F1] VOICE
[F2] OUTPUT
[F3] EQ
[F4] TONE
[F5] RCV SW

Mixing Job

[F1] INIT
[F2] RECALL
[F3] COPY
[F4] BULK

Mixing Voice Edit

Common Edit

[F1] GENERAL
[F2] OUTPUT
[F4] CTL SET
[F5] LFO
[F6] EFFECT

Element Edit

[F1] OSC
[F2] PITCH
[F3] FILTER
[F4] AMP
[F5] LFO
[F6] EQ

Mixing Voice Job

[F2] RECALL
[F3] COPY
[F5] DELETE

Supplementary Information

Determining how Song/Pattern data is converted to an Arpeggio – Convert Type

MIDI sequence data (of Song/Pattern Tracks) can be converted to Arpeggio data in one of three ways, according to the Convert types below. These types can also be selected independently for each destination Track—providing enormous flexibility and performance control.

Normal (Normal Arpeggio)	The Arpeggio is played back using only the played note and its octave notes.
Fixed	Playing any note(s) will trigger the same MIDI sequence data.
OrgNotes (Original Notes)	Basically same as “Fixed” with the exception that the Arpeggio playback notes differ according to the played chord.

Record the MIDI sequence data to a Song or Pattern Track, referring to the previous instructions in this chapter as needed. The examples listed below are used as reference.

• Creating a rhythm pattern (using a Drum Voice)

Track 1	Record a basic rhythm pattern using various drum instruments.	Convert via “Fixed.”
Track 2 – 4	Record a different rhythm pattern using a specific drum instrument to each Track.	Convert via “Normal.”

• Creating a bass line (using a Normal Voice)

Track 1	Record a bass line using a specific desired key (root).	Convert via “OrgNote” after the OrgNotes Root is set.
Track 2 – 4		off

■ Storing the Mixing settings as a Mixing Template

A total of 32 Mixing settings, each designed for a different music category or genre, have been programmed and stored as convenient Mixing templates. Each Mixing Template includes the Voices, effects, pan and other settings suitable for the corresponding music genre. Simply dial up the template that comes closest to the type of Song or Pattern you wish to create, tweak the settings as desired, then start recording. You can also store the Mixing settings you’ve created in the MOXF6/MOXF8 as an original Mixing Template.

Recalling Templates

- To enter Pattern Play, simply press the [SONG]/[PATTERN] button.**
- Press the [MIXING] button, then press the [F6] TEMPLATE button, and then press the [SF1] MIX button to call up the display for setting a Template.**
- Select the desired Template by using the [INC] and [DEC] buttons or the [DATA] dial.**
After the Template is selected, press the [ENTER] button to load the relevant Mixing settings.
- Play the keyboard to check the Mixing settings.**
To select the desired Part, press the [TRACK] button (the lamp lights), then press the appropriate Number [1] – [16] button.

Storing the Mixing settings as a Mixing Template

- Press the [MIXING] button in the Song/Pattern mode, then set the Mixing settings.**
- Press the [STORE] button.**

The Store display for the Song/Pattern mode appears.

NOTE Press the [STORE] button in the Mixing Voice Edit to store the Mixing Voice. To store the Mixing Templates, press the [STORE] button in the Song/Pattern mode, Mixing Play, Mixing Edit, or Mixing Job.

Mixing Mode

Mixing Play

- [F1] VOL/PAN
- [F2] VOICE
- [F3] EF SEND
- [F4] TEMPLATE
- [F5] VCE ED
- [F6] EFFECT

Mixing Edit

Common Edit

- [F1] GENERAL
- [F2] MFX
- [F3] MEQ
- [F4] USB I/O
- [F5] A/D IN
- [F6] EFFECT

Part Edit

- [F1] VOICE
- [F2] OUTPUT
- [F3] EQ
- [F4] TONE
- [F5] RCV SW

Mixing Job

- [F1] INIT
- [F2] RECALL
- [F3] COPY
- [F4] BULK

Mixing Voice Edit

Common Edit

- [F1] GENERAL
- [F2] OUTPUT
- [F4] CTL SET
- [F5] LFO
- [F6] EFFECT

Element Edit

- [F1] OSC
- [F2] PITCH
- [F3] FILTER
- [F4] AMP
- [F5] LFO
- [F6] EQ

Mixing Voice Job

- [F2] RECALL
- [F3] COPY
- [F5] DELETE

Supplementary Information

3 Press the [F2] TEMPLATE button.

4 Set the Template number and name.

5 Press the [ENTER] button.

After the confirmation prompt appears, press the [ENTER] button to store the new template. To cancel the operation, press the [EXIT] button.

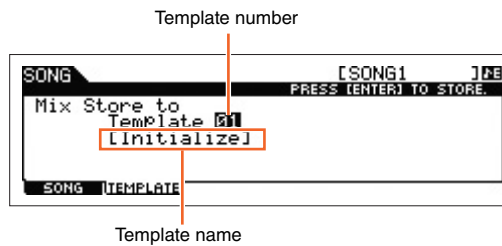

Mixing Mode

Mixing Play

- [F1] VOL/PAN
- [F2] VOICE
- [F3] EF SEND
- [F4] TEMPLATE
- [F5] VCE ED
- [F6] EFFECT

Mixing Edit

Common Edit

- [F1] GENERAL
- [F2] MFX
- [F3] MEQ
- [F4] USB I/O
- [F5] A/D IN
- [F6] EFFECT

Part Edit

- [F1] VOICE
- [F2] OUTPUT
- [F3] EQ
- [F4] TONE
- [F5] RCV SW

Mixing Job

- [F1] INIT
- [F2] RECALL
- [F3] COPY
- [F4] BULK

Mixing Voice Edit

Common Edit

- [F1] GENERAL
- [F2] OUTPUT
- [F4] CTL SET
- [F5] LFO
- [F6] EFFECT

Element Edit

- [F1] OSC
- [F2] PITCH
- [F3] FILTER
- [F4] AMP
- [F5] LFO
- [F6] EQ

Mixing Voice Job

- [F2] RECALL
- [F3] COPY
- [F5] DELETE

Supplementary Information

Master Mode

This synthesizer is loaded with such a wealth of different features, functions and operations, you may find it difficult to locate and call up the particular feature you need. This is where the Master function comes in handy. The MOXF6/MOXF8 has space for a total of 128 of your own User Master settings. You can use it to memorize the operations you use most often in each mode, and call them up instantly anytime you need them with a single button press.

Master Play

To enter Master Play and call up the Master Play display, press the [MASTER] button from the current mode.

Operation	Press the [MASTER] button.
------------------	----------------------------

[F1] PLAY

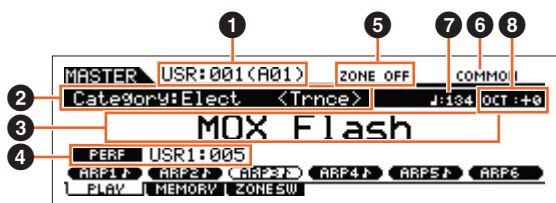

1 Master Number (Group/Number)

Indicates the selected Master number.

2 Main Category <Sub Category>/ Voice

When the memorized mode is Voice or Performance, this indicates the Main Category and Sub Category of the Voice/Performance. When the memorized mode is Song or Pattern, this indicates the Voice assigned to the currently selected Track.

3 Master Name

Indicates the name of the current Master.

4 Mode

Indicates the mode memorized to the current Master. One of the modes (VOICE, PERF, PATTERN, SONG) is indicated here.

5 Zone Switch

Indicates the "ZoneSwitch" setting ([page 129](#)).

6 Current Part/ Current Track

When the memorized mode is Performance, this indicates the currently selected part (Current Part) of the Performance. When the memorized mode is Song or a Pattern, this indicates the currently selected Track. When the memorized mode is Voice, there is no indication.

7 j (Arpeggio Tempo)

Indicates the Arpeggio Tempo set for the current Master.

NOTE This parameter can be set also by holding the [SHIFT] button and pressing the [ENTER] button several times repeatedly at the desired tempo. This function is referred to as "Tap Tempo."

8 OCT (Octave)

Indicates the Keyboard Octave setting.

Master Mode

Master Play	
▶	[F1] PLAY
	[F2] MEMORY
	[F3] ZONE SW
Master Edit	
Common Edit	
	[F1] NAME
Zone Edit	
	[F1] TRANS
	[F2] NOTE
	[F3] TX SW
	[F4] PRESET
	[F5] KNOB
Master Job	
	[F1] INIT
	[F4] BULK

[SF1] ARP1 (Arpeggio 1) – [SF6] ARP6 (Arpeggio 6) [SF1] SCN1 (Scene 1) – [SF6] SCN6 (Scene 6)

When the memorized mode is Voice, Performance, or Pattern, a different Arpeggio type is assigned to each of the [SF1] ARP1 – [SF6] ARP6 buttons according to the Voice/Performance/Pattern number. The Arpeggio types are assigned to the buttons with 8th note icons on the display tab. You can call them up by pressing these buttons any time during your keyboard performance. When the memorized mode is Song, a different Scene setting is assigned to each of the [SF1] – [SF6] buttons according to the Song number. You can call up the mute settings or solo settings for the Tracks by pressing these buttons any time during your keyboard performance.

NOTE The Arpeggios can be registered in the Arpeggio Edit display. For detailed instructions on registering Scenes, see “Registering the Song Scene” on [page 98](#).

[F2] MEMORY

Mode

Determines the mode that is called up when the Master number is selected.

Settings: Voice, Performance, Song, Pattern

Memory

Determines the Program number that is called up when the Master is selected.

Settings: When the Mode is set to Voice: Select a Voice bank and number.
When the Mode is set to Performance: Select a Performance bank and number.
When the Mode is set to Song: Select a Song number.
When the Mode is set to Pattern: Select a Pattern number.

[F3] ZONE SW (Zone Switch)

ZoneSwitch

Determines whether the Zone function is used (on) or not (off). See [page 130](#) for details about the Zone function.

Settings: off, on

NOTE When the Mode is set to “Voice” or “Performance” and the Zone Switch is turned on, only Zone 1 can be used in the default setting (playing Zones 2 – 4 will produce no sound). You can use these Zones by setting various parameters in the Master Edit mode.

ZoneKnob

When ZoneSwitch is set to “on,” this determines whether the Zone Edit settings are assigned to Knobs 1 – 8 (on), or the settings in the memorized mode are assigned to the Knobs 1 – 8 (off).

Settings: off, on

NOTE When ZoneSwitch is set to “on,” pressing Knob Function 1 and 2 buttons simultaneously can also set ZoneKnob to on/off. When this parameter is set to on, the LED indicators of the Knob Function 1 and 2 buttons are turned off.

HINT

You can conveniently use the Number buttons to easily turn the Internal/External Switch ([page 130](#)) for each Zone on and off. When the Internal/External Switch for a Zone is on, the corresponding button ([1] – [4] or [9] – [12]) lights.

First, make sure the following settings are active:

Master Play	
Mode	Song
ZoneSwitch	on

Then, press the relevant [PERFORMANCE CONTROL] button:

[1] – [4] buttons	Changes IntSw on/off settings for Zone1 – 4.
[9] – [12] buttons	Changes ExtSw on/off settings for Zone1 – 4.

Master Mode

Master Play

- ▶ [F1] PLAY
- ▶ [F2] MEMORY
- ▶ [F3] ZONE SW

Master Edit

Common Edit

[F1] NAME

Zone Edit

[F1] TRANS

[F2] NOTE

[F3] TX SW

[F4] PRESET

[F5] KNOB

Master Job

[F1] INIT

[F4] BULK

Master Edit

The Master Edit mode lets you create your own original Master programs—containing up to four different Zones (keyboard areas)—by editing the various parameters. In the Master mode, you can divide the keyboard into (up to) four independent areas (called “Zones”). To each Zone can be assigned different MIDI channels and different functions of the Knobs and Control Sliders. This makes it possible to control several Parts of the multi-timbral tone generator simultaneously by a single keyboard or to control Voices of an external MIDI instrument over several different channels in addition to the internal Voices of this synthesizer itself—letting you use the MOXF6/MOXF8 to effectively do the work of several keyboards. There are two types of Master Edit displays: those for editing parameters common to all four Zones and those for editing individual Zones. This section explains the parameters for Common Edit and Part Edit.

Common Edit

Operation [MASTER] → Master selection → [EDIT] → [COMMON]

[F1] NAME

From this display you can create a name for the Master. For detailed instructions on naming, see the “Basic Operation” of the Owner’s Manual.

Zone Edit

Operation [MASTER] → Master selection → [EDIT] → Number [1] – [4]

[F1] TRANS (Transmit)

From this display you can set how each Zone transmits MIDI messages when you play the keyboard.

TransCh (Transmit Channel)

Determines the MIDI Transmit Channel for each Zone.

Settings: 1 – 16

IntSw (Internal Switch)

Determines whether or not MIDI data for each Zone is transmitted to the internal tone generator.

Settings: off, on

ExtSw (External Switch)

Determines whether or not MIDI data for each Zone is transmitted to an external MIDI device.

Settings: off, on

[F2] NOTE

From this display you can set the pitch- and keyboard-related parameters for each zone.

Octave

Determines the amount in octaves by which the range of the Zone is shifted up or down. You can adjust the offset up or down over a maximum range of three octaves.

Settings: -3 – +0 (Default) – +3

Transpose

Determines the amount in semitones by which the range of the Zone is shifted up or down.

Settings: -11 – +0 (Default) – +11

NoteLimitH, L (Note Limit High, Low)

Determines the lowest and highest notes of the range for each Zone. The selected Zone will sound only when you play notes within this range.

Settings: C -2 – G8

NOTE You can also set the note directly from the keyboard, by holding down the [SF6] KBD button and pressing the desired key.

Master Mode

Master Play

[F1] PLAY

[F2] MEMORY

[F3] ZONE SW

Master Edit

Common Edit

▶ [F1] NAME

Zone Edit

▶ [F1] TRANS

▶ [F2] NOTE

[F3] TX SW

[F4] PRESET

[F5] KNOB

Master Job

[F1] INIT

[F4] BULK

[F3] TX SW (Transmit Switch)

From this display you can set how each individual zone affects transmission of various MIDI data, such as Control Change and Program Change messages. When the relevant parameter is set to “on,” playing the selected zone will transmit the corresponding MIDI data. Note that two different display types listed below are available and you can switch between them by pressing the [SF6] button. Each display type features the same settings in a different format; use the type you feel most comfortable with.

- Display showing four Zones
- Display showing all parameters for one Zone

Settings: See below.

Bank (TG)	Determines whether or not to transmit Bank Select MSB/LSB messages to the internal tone generator.
PC (TG).....	Determines whether or not to transmit Program Change messages to the internal tone generator.
Bank (MIDI)	Determines whether or not to transmit Bank Select MSB/LSB messages to the internal tone generator.
PC (MIDI).....	Determines whether or not to transmit Program Change messages to the external tone generator via MIDI.
PB (Pitch Bend)	Determines whether or not to transmit Pitch Bend messages to the internal and external tone generator.
MW (Modulation Wheel)	Determines whether or not to transmit MIDI messages generated by using the Modulation Wheel to the internal and external tone generator.
FC1 (Foot Controller 1)	Determines whether or not to transmit MIDI messages generated by pressing the optional Foot Controller to the internal and external tone generator.
Sus (Sustain)	Determines whether or not to transmit Control Number 64 (Sustain) messages to the internal and external tone generator. This parameter is not available for the Drum Voice Parts.
FS (Foot Switch)	Determines whether or not to transmit MIDI messages generated by pressing the Footswitch connected to the FOOT SWITCH [ASSIGNABLE] jack to the internal and external tone generator.
Knob	Determines whether or not to transmit MIDI messages generated by using the Knobs to the internal and external tone generator.
A.Func1 (Assignable Function 1) /A.Func2 (Assignable Function 2)	Determines whether or not to transmit MIDI messages generated by pressing the ASSIGNABLE FUNCTION [1] and [2] buttons to the internal tone generator.
Vol/Exp (Volume/Expression)...	Determines whether or not to transmit volume messages to the internal and external tone generator.
Pan	Determines whether or not to transmit Pan messages to the internal and external tone generator.

Master Mode

Master Play

- [F1] PLAY
- [F2] MEMORY
- [F3] ZONE SW

Master Edit

Common Edit

- [F1] NAME

Zone Edit

- [F1] TRANS
- [F2] NOTE
- ▶ [F3] TX SW
- ▶ [F4] PRESET
- [F5] KNOB

Master Job

- [F1] INIT
- [F4] BULK

[F4] PRESET

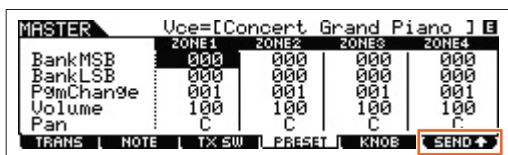

From this display you can make Voice-related settings for each Zone in the selected Master program number.

NOTE By using the [F6] SEND button, you can select whether the settings in PRESET display are immediately applied or not. If the [F6] SEND button is turned on (SEND ON), the relevant MIDI messages will be output from the MOXF6/MOXF8 as soon as you change each parameter in this display. If the [F6] SEND button is turned off (SEND OFF), the MIDI messages will be output from the MOXF6/MOXF8 after you store the edited Master and then select the Master again. However, the parameters set to off in the [F1]TRANS or [F3]TX SW display cannot be output.

BankMSB (Bank Select MSB)

BankLSB (Bank Select LSB)

PgmChange (Program Change)

Determines the Voice assignment for each Zone in the selected Master.

Settings: See the “Voice List” in the “Data List” PDF document.

Volume

Determines the output level of the Voice in each Zone.

Settings: 0 – 127

Pan

Determines the stereo pan position of the Voice in each Zone.

Settings: L64 (far left) – C (center) – R63 (far right)

[F5] KNOB

CtrlKnobUp (Control Knob Upper)

CtrlKnobLo (Control Knob Lower)

From this display you can determine which Control Change numbers are used for the Knobs for each Zone. These settings are available only when the "ZoneKnob" parameter (in the [F3] ZONE SW display in Master Play) is set to "on."

Settings: off, 1 – 95

Master Job

The Voice Job mode features several basic operations, such as Initialize and Copy. After setting parameters as required in the selected display, press the [ENTER] button to execute the Job.

[F1] INIT (Initialize)

This function lets you reset (initialize) all Master parameters to their default settings. It also allows you to selectively initialize certain parameters, such as Common settings, settings for each Zone, and so on—very useful when creating a completely new Master from scratch.

Type of parameter to be initialized: All, Common, Zone

All	All settings for the selected Master are initialized.	
Common	Common parameter settings for the selected Master are initialized.	
Zone	The Zone settings are initialized. You can initialize the zone setting to one of the following three types.	
	Split	Splits the keyboard range using Zone 1 and Zone 2. "UpperCh" determines the MIDI transmit channel of the upper range of the keyboard, "LowerCh" determines the MIDI transmit channel of the lower range of the keyboard, and "SplitPoint" determines the note (C2 – G8) number which separates the upper range and lower ranges of the keyboard.
	4Zone	Initializes all four Zones.
	Layer	Lets you layer two parts using Zone 1 and Zone 2. "UpperCh" and "LowerCh" determine the MIDI transmit channels of the two Zones respectively.

[F4] BULK (Bulk Dump)

This function lets you send all your edited parameter settings for the currently selected Master to a computer or another MIDI device for data archiving. Press the [ENTER] button to execute the Bulk Dump.

NOTE In order to execute Bulk Dump, you will need to set the correct MIDI Device Number, with the following operation: [UTILITY] → [F6] MIDI → [SF1] CH → "DeviceNo."

Master Mode

Master Play

▶ [F1] PLAY

▶ [F2] MEMORY

▶ [F3] ZONE SW

Master Edit

Common Edit

▶ [F1] NAME

Zone Edit

▶ [F1] TRANS

▶ [F2] NOTE

▶ [F3] TX SW

▶ [F4] PRESET

▶▶ [F5] KNOB

Master Job

▶▶ [F1] INIT

▶▶ [F4] BULK

Remote Mode

Remote Mode

In the Remote mode, you can use the Knobs and buttons of this instrument to control the sequencer Tracks and mixer channels of the DAW software on the computer. For example, you can start/stop playback of the DAW software on the computer by using the Function buttons and control the song position on the DAW software by using the [DATA] dial, [INC] and [DEC] buttons instead of using the mouse or keyboard of the computer. The DAW applications Cubase, Logic, SONAR and Digital Performer can be controlled by the MOXF6/MOXF8 in the Remote mode. The Remote settings are made in "Remote Select" in the REMOTE display of the Utility mode.

Remote display

Remote Control Assignments

Operation	Press the [DAW REMOTE].
------------------	--------------------------------

NOTE To leave the Remote mode, press the [DAW REMOTE] button again.

NOTE For the version of the DAW software which is compatible with the MOXF6/MOXF8, see the "Specifications" section in the Owner's Manual.

Remote display

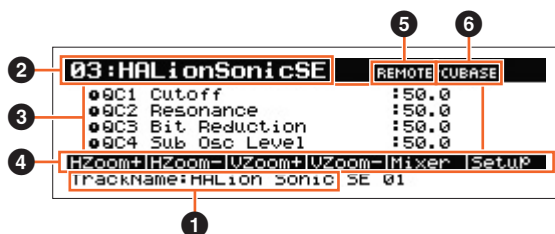

1 TrackName

When the DAW software which is set in the "DAW Select" of the Utility mode is set to Cubase, this indicates the current Track in Cubase.

2 Control Template Number, Template Name

The MOXF6/MOXF8 provides 50 Control Templates which can be used for various VSTi plug-ins. By selecting the desired one from 50 Control Templates, you can assign the functions appropriate for the current VSTi to Knobs 1 – 4. This parameter determines the Control Template number.

NOTE Use the MOXF6/MOXF8 Remote Editor for editing the Control Template. The MOXF6/MOXF8 Remote Editor can be downloaded from the following website address: <http://download.yamaha.com/>
For instructions, see the PDF manual included with the MOXF6/MOXF8 Remote Editor.

NOTE When the DAW software which is set in the Utility mode is set to Cubase, switching the VSTi on the Cubase changes the Control Template set in the MOXF6/MOXF8 consecutively. When the DAW software which is set in the Utility mode is set to something other than Cubase, switching the VSTi on the DAW software does not affect the Control Template set in the MOXF6/MOXF8. You should set the appropriate Control Template manually to match the VSTi on the DAW software.

3 Parameter Name

Shows the parameters which can be changed via Knobs 1 – 8 on the panel.

4 Function Names

Indicates the names of Cubase functions assigned to the [SF1] – [SF6] buttons.

5 Parameter Values of the Knob Output Select in each Template

Indicates the parameter values of the Knob Output Select set in the Remote Template. The Knob Output Select of the Remote Template can be set with the MOXF6/MOXF8 Remote Editor. In the following conditions, the setting of the Knob Out Select parameter will automatically be shown as "CC."

- The DAW software which is set in the Utility mode is set to something other than Cubase.
- The "MIDI In/Out" parameter (page 149) is set to "MIDI."
- The USB cable is not connected to the MOXF6/MOXF8.

6 Name of the Remote Control Software

Indicates the name of the DAW software which is set in "DAW Select" of the Utility mode (page 141).

Remote Control Assignments

Remote Mode

- Remote display
- Remote Control Assignments

Switching the Control Template for the VSTi

To switch the Control Templates of the MOXF6/MOXF8, use the BANK SELECT [DEC]/[INC] buttons.

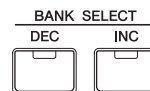

Switching the functions of Knobs 1 – 4

Press the Knob Function 1 button to switch the functions assigned to the Knobs 1 – 4 in descending order, “1” | “2” | “3.” Each function differs depending on the selected Control Template. For details, confirm on the MOXF6/MOXF8 Remote Editor. The relevant lamp of the functions assigned to the Knobs is turned on. When the functions are shown in the display, the lamp flashes.

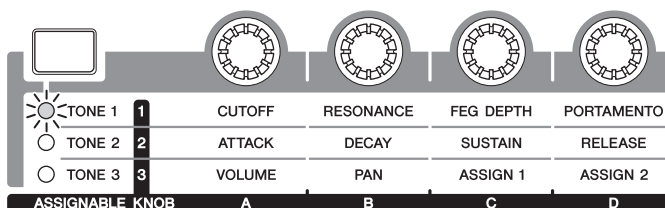

NOTE Hold down the [SHIFT] button and press Knob Function 1 button to set the functions of Knobs 1 – 4 to “1.”

NOTE Use the MOXF6/MOXF8 Remote Editor to edit the Control Template.

Switching the functions of Knobs 5 – 8

Knobs 5 – 8 are available only when “DAW Select” is set to “Cubase” in the Utility mode. Press Knob Function 2 button to switch the functions assigned to the Knobs 5 – 8 in descending order, “Q” | “F” | “G.” Knobs 5 – 8 also control the Low, Low Mid, High Mid, and High bands. This operation is linked with the Track EQ parameter in Cubase. The relevant lamp of the functions assigned to the Knobs is turned on. When the functions are shown in the display, the lamp flashes.

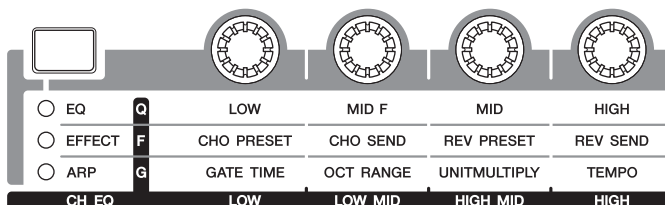

NOTE Hold down the [SHIFT] button and press Knob Function 2 button to set the functions of Knobs 5 – 8 to “Q.”

Transport operation

The SEQ TRANSPORT buttons also function as DAW transport controls.

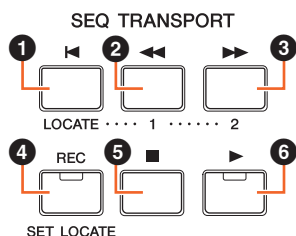

- 1 Top (Move to the top of the Song)
- 2 Rewind
- 3 Forward
- 4 Record
- 5 Stop
- 6 Play

Operating by the Function buttons

The functions of the DAW software can be operated by the Function buttons and Sub Function buttons. When “DAW Select” is set to “Cubase,” the appropriate functions of Cubase are assigned to the buttons. This section explains about the specific functions for the Function buttons when “DAW Select” is set to “Cubase.”

NOTE When “DAW Select” is set to something other than Cubase, the functions assigned to the Function buttons may not be appropriate. Before using the Function buttons, assign desired functions to the Function buttons on the DAW software. Please note that these buttons don't work when “DAW Select” is set to Digital Performer.

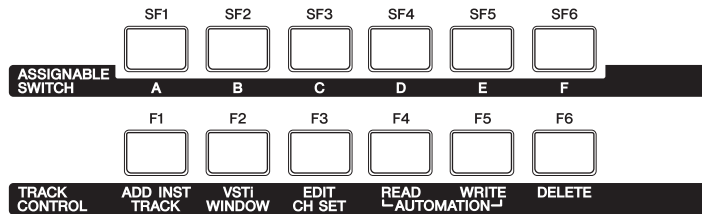

Remote Mode

Remote display

Remote Control Assignments

Functions for the Function buttons

When “DAW Select” is set to “Cubase,” the following fixed functions are assigned to the [F1] – [F6] buttons.

Buttons	Panel Indication	Functions
F1	ADD INST TRACK	Opens/closes the [Add Instrument Track] dialog.
F2	VSTi WINDOW	Opens/closes the VSTi display for the selected Track.
F3	EDIT CH SET	Opens/closes the settings window for the channel of the selected Track.
F4	AUTOMATION READ	Switches Automation Read for the selected Track on or off.
F5	AUTOMATION WRITE	Switches Automation Write for the selected Track on or off.
F6	DELETE	Delete

Functions for the Sub Function buttons

The [SF1] – [SF6] buttons can be assigned freely to any desired function. When “DAW Select” is set to “Cubase,” you can use six memories to which functions assigned to the [SF1] – [SF6] buttons are registered. You can register the functions for the [SF1] – [SF6] buttons to each memory. To switch among Memory settings 1 – 6, use the [A] – [F] buttons on the MOXF6/MOXF8 panel. The functions assigned to the Sub Function buttons can be edited in the MOXF6/MOXF8 Extension Setup window in Cubase ([page 136](#)).

Remote Mode

- Remote display
- Remote Control Assignments

MOXF6/MOXF8 Extension Setup window

The functions can be assigned to the [SF1] – [SF6] buttons in the MOXF6/MOXF8 Extension Setup window shown in Cubase. This section explains about the MOXF6/MOXF8 Extension Setup window.

Startup Method

Select the “Device” menu, then select the “MOXF6/MOXF8 Extension Setup” in Cubase. Indicates the MOXF6/MOXF8 Extension Setup window.

NOTE When the default settings of the Memory 1 are assigned to the Function buttons, you can also start the MOXF6/MOXF8 Extension Setup window by pressing the [SF6] button on the MOXF6/MOXF8 panel.

About the settings for the MOXF6/MOXF8 Extension Setup window

The MOXF6/MOXF8 Extension Setup window contains the SF Assign window, SF Assign (Quick) window, and Option window. Pressing the tabs switches among the three windows.

SF Assign window

This window assigned the functions to selected one of the Sub Function buttons. You can select one of the Sub Function buttons by clicking the [SF1] – [SF6] button on the window.

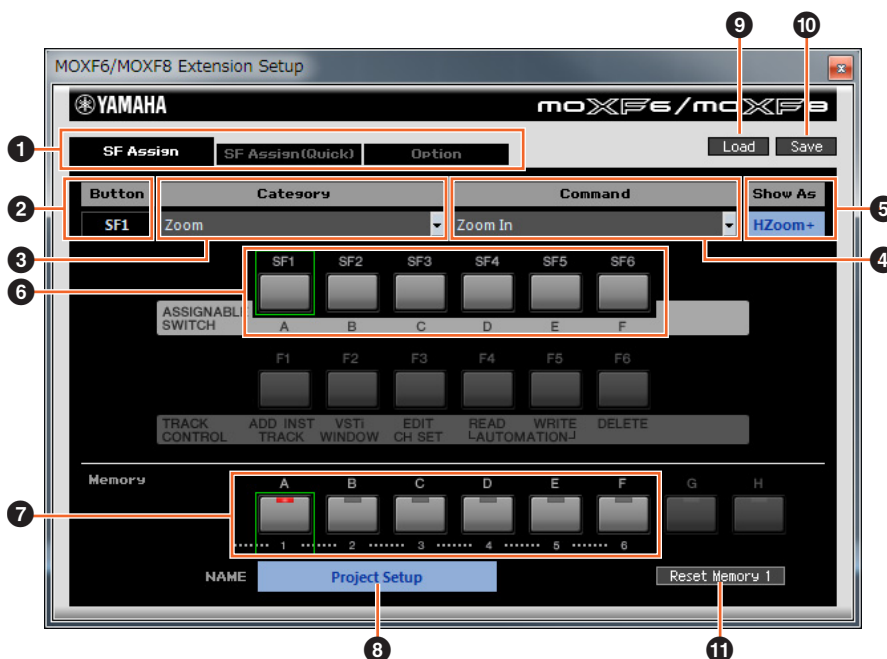

1 [SF Assign] tab, [SF Assign (Quick)] tab, [Option] tab

Click one of the tabs to switch windows.

2 Button

Indicates the selected button for editing.

3 Category

Selects the category for the functions assigned to the selected button.

4 Command

Selects the function contained in the selected category.

5 Show As

Determines the display indication of the selected function. The display indication can be up to six characters in length.

6 [SF1] – [SF6] buttons

These buttons correspond to the [SF1] – [SF6] buttons on the MOXF6/MOXF8 panel. Determines which button is to be assigned and used for the selected Set.

7 Buttons for the Memory 1 – 6

Determines which Memory is assigned to the [SF1] – [SF6] buttons.

8 Memory name

Determines the name for the Memory specified by parameter (7) above; maximum 16 characters in length.

9 Load

Loads the file to which the settings of the MOXF6/MOXF8 Extension Setup window are stored.

10 Save

Settings other than the Option window in the MOXF6/MOXF8 Extension Setup window are stored as a file.

11 Reset Memory 1/2/3/4/5/6

Clicking these buttons restores the default settings of the selected Memory to the [SF1] – [SF6] buttons.

NOTICE

Restoring the default data by clicking the Reset Memory button overwrites the registered functions for the [SF1] – [SF6] buttons to the selected Memory.

SF Assign (Quick) window

This window assigns functions to the [SF1] – [SF6] buttons. The setting menu is the same as the SF Assign window. In SF Assign (Quick) window, you can assign the functions with the [SF1] – [SF6] buttons shown on the window.

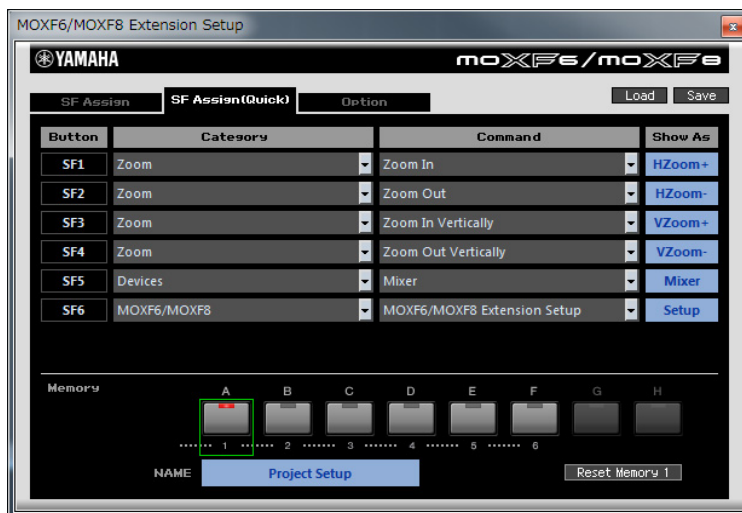

Option window

When moving the project cursor of the Cubase by operating the jog dial, this determines whether the cursor stops immediately when jog operation is stopped (on), or slows down gradually before stopping (off).

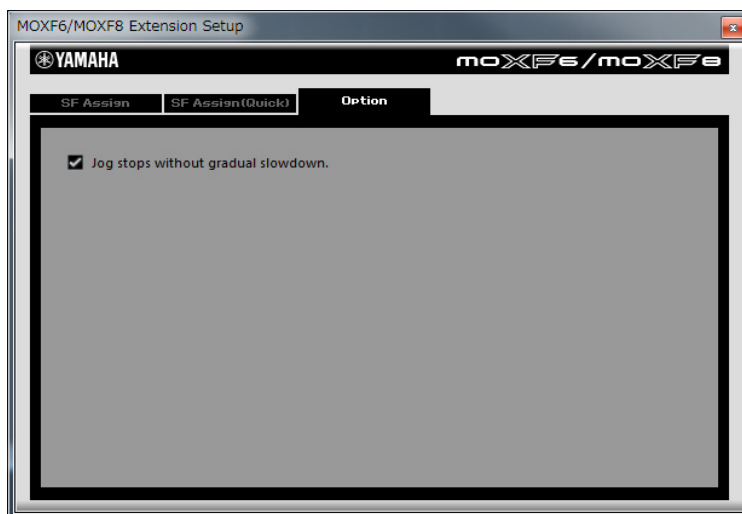

Remote Mode

Remote display

Remote Control Assignments

Mute/Solo

You can mute or solo the currently selected Track in Cubase by pressing the respective [MUTE]/[SOLO] button on the MOXF6/MOXF8.



Remote Mode

- Remote display
- Remote Control Assignments

Moving the cursor/ Program Change function

The cursor [<]/[^]/[v]/[>] buttons work as cursor controls on the DAW software. The [EXIT] button works as the <Esc> key on a computer, while the [ENTER] button works as the <Enter> key. The [INC]/[DEC] buttons switch the VSTi program on the DAW software. However, when "Remote Select" is set to "Cubase," the functions of the [INC]/[DEC] buttons differ depending on the "ProgramChangeMode" setting of the MOXF6/MOXF8.

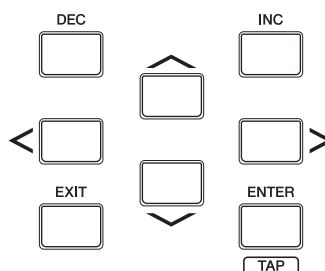

"ProgramChangeMode" setting	Functions
remote	Pressing the [INC] button selects the next program, while pressing the [DEC] button selects the previous program.
PC	Allows you to select the program corresponding to the specified number by using the [INC] / [DEC] buttons. When specifying a program number outside the actual range of programs, the program will not be changed. When using the VST3, pressing the [INC]/[DEC] buttons cannot change the program.
auto	When the selected Track is a MIDI Track, and the output destination of the MIDI Track is not VSTi, the [INC]/[DEC] function is same as when "ProgramChangeMode" is set to "PC." In other cases, the [INC]/[DEC] function is same as when "ProgramChangeMode" is set to "remote."

When the "DAW Select" is set to something other than "Cubase," the "ProgramChangeMode" is always set to "PC."

Inputting a Number Directly

The number [1] – [9] buttons work as the numeric keys 1 – 9 in Cubase. The number [10] works as the numeric key 0 on Cubase. The number [14] works as the numeric key ".", the number [15] works as the numeric key "-", and the number [16] works as the numeric key "+". You can use these number buttons when inputting a parameter number directly or switching the tool functions in Cubase.

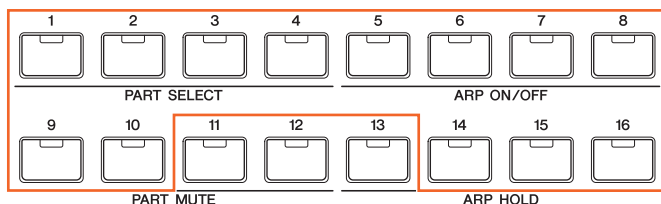

AI KNOB functions

The [DATA] dial of the MOXF6/MOXF8 works as the AI KNOB. The AI KNOB can control a desired parameter within the principal window and plug-in software in Cubase, specified via the mouse pointer (as long as the [LOCK] button and [JOG] button are turned off). The [CATEGORY SEARCH] button works as the [JOG] button, and the [FAVORITE] button works as the [LOCK] button. The parameters which are available for control by AI KNOB will differ according to the on/off status of the [JOG] button and [LOCK] button as follows.

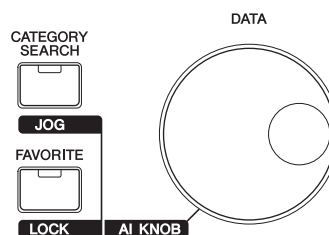

[JOG] button	[LOCK] button	AI KNOB functions
off	off	Operates the parameter specified via the mouse pointer in Cubase.
off	on	When you locate the mouse pointer to the desired parameter then turn the [LOCK] button on, the AI KNOB will control the "locked" parameter regardless of the mouse pointer's position.
on	off	Moves the time position of the current project. The MOXF6/MOXF8 Extension Setup window (page 136) determines whether the cursor stops immediately when jog operation is stopped (on), or slows down gradually before stopping (off).
on	on	Moves the time position of the current project. Moving of the time position will not stop even if you stop operating the AI KNOB. You can stop playback at any time by pressing the [■] (Stop) button.

Utility settings

Press the [UTILITY] button to call up the display for the Utility settings dedicated to the Remote mode. See [page 141](#) for details about the each parameter.

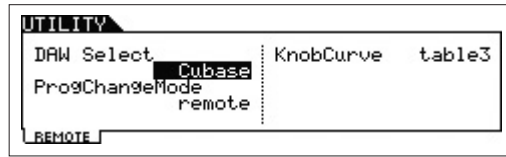

Remote Mode

Remote display

Remote Control Assignments

Utility Mode

In the Utility mode, you can set parameters that apply to the entire system of the MOXF6/MOXF8. This mode is actually a sub-mode of the Voice/Performance/Song/Pattern mode. Press the [UTILITY] button in each mode to enter the Utility mode and press the [EXIT] button after making settings to go back to the previous mode.

Operation

Press the [UTILITY] button.

[F1] GENERAL

[SF1] TG (Tone Generator)

From this section, you can make overall settings for the internal tone generator. The settings here only affect the internal tone generator block. The MIDI output will not be affected.

Volume

Determines the overall volume of the instrument.

Settings: 0 – 127

NoteShift

Determines the amount (in semitones) by which the pitch of all notes is shifted.

Settings: -24 – +0 – +24

Tune

Determines the fine tuning of the MOXF6/MOXF8's overall sound (in 0.1 cent steps).

Settings: -102.4 – +0.0 – +102.3

SystemFxOn/OffBtn Chorus (System Effect On/Off Button Chorus)

Determines whether or not the System Effect (Chorus) is actually applied when the EFFECT ON/OFF [SYSTEM] button is turned on.

Settings: off, on

SystemFxOn/OffBtn Reverb (System Effect On/Off Button Reverb)

Determines whether or not the System Effect (Reverb) is actually applied when the EFFECT ON/OFF [SYSTEM] button is turned on.

Settings: off, on

[SF2] OUTPUT

L&R Gain

Determines the output gain of the OUTPUT [L/MONO] and [R] jacks.

Settings: 0dB, +6dB

USB 1/2 Gain

USB 3/4 Gain

Determines the output gain of the USB 1/2 channels or USB 3/4 channels.

Settings: 0dB, +6dB

[SF3] KBD (Keyboard)

From this display you can set the keyboard-related parameters. The settings here affect the MIDI messages generated by playing the keyboard.

Octave

Determines the amount in octaves by which the range of the keyboard is shifted up or down. This parameter is linked with the OCTAVE [-]/[+] buttons on the panel.

Settings: -3 – +0 – +3

Transpose

This parameter is used to transpose the current zone in units of one semitone.

Settings: -11 – +0 – +11

NOTE If you transpose beyond the note range limits (C -2 and G8), notes in the adjacent octaves will be used.

Utility Mode

- ▶ [F1] GENERAL
- [F2] VOICE
- [F2] SEQ
- [F3] VCE A/D
- [F4] CTL ASN
- [F5] USB I/O
- [F6] MIDI

Utility Job

VelCurve (Velocity Curve)

These five curves determine how the actual velocity will be generated and transmitted according to the velocity (strength) with which you play notes on the keyboard. The graph shown in the display indicates the velocity response curve. (The horizontal line represents the received velocity values (strength of your playing), while the vertical line represents the actual velocity values transmitted to the internal/external tone generators.)

Settings: norm, soft, hard, wide, fixed

norm (normal).... This linear "curve" produces one-to-one correspondence between the strength of your keyboard playing (velocity) and the actual sound change.

soft..... This curve provides increased response, especially for lower velocities.

hard..... This curve provides increased response, especially for higher velocities.

wide..... This curve accentuates your playing strength by producing lower velocities in response to softer playing and louder velocities in response to harder playing. As such, you can use this setting to expand your dynamic range.

fixed..... This setting produces the same amount of sound change (set in Fixed Velocity below), no matter what your playing strength. The velocity of the notes you play are fixed at the value set here.

FixedVelocity

The Fixed curve can be used to send a fixed velocity to the tone generator regardless of how hard or soft you play the keyboard. This parameter is only available if you select the "fixed" Velocity Curve above.

Settings: 1 – 127

[SF4] PERF CRE (Performance Creator)

This display determines the parameters related to the Performance Creator which uses the [LAYER]/[SPLIT]/[DRUM ASSIGN] buttons.

Layer Bank (Layer Voice Bank), Layer Number (Layer Voice Number)

Determines the Voice assigned first when using the Layer function of the Performance Creator. Select the desired Voice by setting the Bank and Number. The Name is determined automatically.

Split Bank (Split Voice Bank), Split Number (Split Voice Number)

Determines the Voice assigned first when using the Split function of the Performance Creator. Select the desired Voice by setting the Bank and Number. The Name is determined automatically.

Split Lower/Upper

Determines the keyboard area to which the Voice is assigned when executing the Split function of the Performance Creator. When "both" is selected, the first Voice is assigned to all the notes on the keyboard. When "lower" is selected, the first Voice is assigned to the area lower than the Split Point. When "upper" is selected, the first Voice is assigned to the Split Point and higher.

Settings: both, lower, upper

DrumAssign Bank (Drum Assign Voice Bank), Number (Drum Assign Voice Number)

Determines the Voice assigned first when using the Drum Assign function of the Performance Creator. Select the desired Voice by setting the Bank and Number. The Name is determined automatically.

ConfirmPopup

If executing the Performance Creator with the Edit Indicator (E) shown in the Voice mode, the edited data will be lost. This parameter determines whether or not the confirmation prompt appears before executing the Performance Creator.

Settings: off, on

[SF5] REMOTE

This section enables you to set the locate points. When pressing the [UTILITY] button in the Remote mode, only this REMOTE display is shown.

DAW Select

Determines the DAW software to be controlled by the MOXF6/MOXF8. Simply selecting a DAW type calls up the appropriate Remote settings automatically.

Settings: Cubase, LogicPro, DigiPerf, SONAR

Utility Mode

[F1] GENERAL

[F2] VOICE

[F2] SEQ

[F3] VCE A/D

[F4] CTL ASN

[F5] USB I/O

[F6] MIDI

Utility Job

ProgChangeMode (Program Change Mode)

Determines what messages will be transmitted to the computer when you operate the [INC]/[DEC] buttons or [DATA] dial. When "PC" is selected, Program Change messages will be transmitted via MIDI Port 1. When "remote" is selected, Remote Control messages will be transmitted via MIDI Port 2. When "auto" is selected, this automatically switches whether Program Change messages will be transmitted via MIDI Port 1 or Remote Control messages will be transmitted via MIDI Port 2 according to the DAW software controlled in the Remote mode. The Remote Control messages can be transmitted only when the VSTi in Cubase is controlled in the Remote mode.

Settings: auto, PC, remote

NOTE This parameter is fixed to "PC" when the "DAW Select" is set to something other than "Cubase."

[SF6] OTHER

Mic/Line

When using the A/D INPUT [L]/[R] jacks, this determines the input source, microphone (mic) or line.

Settings: mic, line

mic..... Intended for low output equipment, such as a microphone, electric guitar or bass.

line..... Intended for high output equipment, such as a keyboard, synthesizer, or CD player.

CtrlReset (Controller Reset)

Determines the status of the controllers (Modulation Wheel, Aftertouch, Foot Controller, Breath Controller, Knobs, etc.) when switching between Voices. When this is set to "hold," the controllers are kept at the current setting. When this is set to "reset," the controllers are reset to the default states (below).

Settings: hold, reset

If you select "reset," the controllers will be reset to the following states/positions:

Pitch Bend	Center
Modulation Wheel	Minimum
Aftertouch	Minimum
Foot Controller	Maximum
Footswitch	Off
Ribbon Controller	Center
Breath Controller	Maximum
Assignable Function	Off
Expression	Maximum

PowerOnMode

This determines the default power-on mode (and memory bank) — letting you select which condition is automatically called up when you turn the power on.

Settings: performance, voice (USR1), voice (PRE1), voice (GM), master, STORE+ENTER

When this is set to "STORE+ENTER," the display in which you specify the mode (Voice/Performance/Master/Song/Pattern) and the Program number will automatically be called up when the power is turned on.

To specify a display, call it up normally, then press the [STORE] button and the [ENTER] button simultaneously.

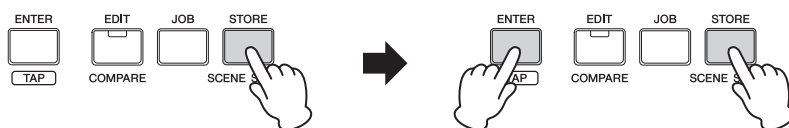

Knob FuncDispSw (Knob Function Display Switch)

Determines whether the KNOB FUNCTION pop-up window appears or not when pressing the Knob Function buttons. The KNOB FUNCTION pop-up window indicates the functions assigned to Knobs and their values.

Settings: off, on

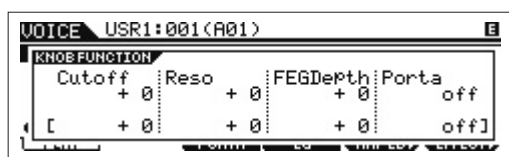

KNOB FUNCTION pop-up window appears when pressing the Knob Function buttons

Utility Mode

- [F1] GENERAL
- [F2] VOICE
- [F2] SEQ
- [F3] VCE A/D
- [F4] CTL ASN
- [F5] USB I/O
- [F6] MIDI

Utility Job

Knob DispTime (Knob Display Time)

Determines whether or not the KNOB FUNCTION pop-up window appears when operating the Knobs, and how long the popup will continue to be shown.

Settings: off, 1 sec, 1.5 sec, 2 sec, 3 sec, 4 sec, 5 sec, keep

off..... When this selected, the popup is not called up even if you operate the Knobs.

1 sec – 5 sec Turning the Knob will cause the popup to appear after an elapsed time of between 1 – 5 seconds, and then automatically close.

keep..... Operating the Knob will cause the popup to be shown continuously until you call up a different display/dialog/popup or press the [ENTER]/[EXIT] button.

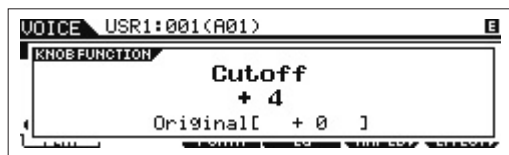

KNOB FUNCTION pop-up window appears when operating the Knobs

Knob Curve

Adjusts the touch response sensitivity in five steps. Larger values provide higher sensitivity, letting you make large changes to the actual value even with slight turning of the Knob.

Settings: table1 – table5

LCD Mode

Switches the backlight of the LCD.

Settings: normal, reverse

LCD Contrast

Adjusts the LCD contrast.

Settings: 1 – 16

[F2] VOICE

These special Voice-related settings are available only when entering the Utility mode from the Voice mode, letting you set parameters related to all the Voices.

[SF1] MFX (Master Effect)

From this display you can set the Master Effect related parameters applied to all the Voices. Details on each parameter are the same as in Performance Common Edit. See [page 60](#).

[SF2] MEQ (Master EQ)

From this display you can apply five-band equalization (LOW, LOW MID, MID, HIGH MID, HIGH) to all Voices. Details on each parameter are the same as in Performance Common Edit. See [page 61](#).

[SF3] ARP CH (Arpeggio Channel)

MIDIOutSwitch (MIDI Output Switch)

This enables or disables MIDI data output for the Arpeggio function. When this is set to “on,” Arpeggio data is sent via MIDI in the Voice mode.

Settings: off, on

TransmitCh (Transmit Channel)

Determines the MIDI channel through which Arpeggio playback data will be sent (when Output Switch above is on).

Settings: 1 – 16

Utility Mode

▶ [F1] GENERAL

▶ [F2] VOICE

[F2] SEQ

[F3] VCE A/D

[F4] CTL ASN

[F5] USB I/O

[F6] MIDI

Utility Job

[F2] SEQ (Sequencer)

These special Song- and Pattern-related settings are available only when entering the Utility mode from the Song or Pattern mode.

[SF1] CLICK

From this display you can set the parameters related to the click sound (metronome) that is used during recording or playback in the Song/Pattern mode.

Mode

Determines whether the metronome click will sound or not, and under what conditions.

Settings: off, rec, rec/play, all
 off..... The click will not sound.
 rec The click will sound during Song/Pattern recording only.
 rec/play..... The click will sound during Song/Pattern recording and playback.
 all..... The click will always sound.

Beat

Determines on which beats the metronome click will sound.

Settings: 6 (16th notes), 08 (8th notes), 04 (quarter notes), 02 (half notes), 01 (whole notes)

Volume

Determines the click sound volume.

Settings: 0 – 127

Type

Determines the click sound type.

Settings: 1 – 10

[SF2] FILTER (MIDI Filter)

Determines the number of count-in measures provided before recording actually starts after pressing the [▶] (Play) button in the Record standby mode.

Settings: off (Recording starts as soon as the [▶] (Play) button is pressed), 1 meas – 8 meas

NOTE Since the click sound is created with the internal tone generator, using click playback affects the overall polyphony of the instrument.

MIDI events to which the Filter is applied:

Note, PgmChange (Program Change), CtrlChange (Control Change), PB (Pitch Bend), ChAt (Channel Aftertouch), PolyAT (Polyphonic Aftertouch), Exclusive

[SF3] OTHER

PtnQuantize (Pattern Quantize)

Determines the quantize value for Pattern switching during playback.

Settings: 1 (1 measure), 1/2 (Half note), 1/4 (Quarter note), 1/8 (8th note), 1/16 (16th note)

PtnTempoHold (Pattern Tempo Hold)

Determines whether or not the tempo setting will switch to the tempo value stored with each Pattern when a new Pattern is selected during playback. When set to "on," the tempo will be retained when Patterns are switched. When set to "off," the tempo will switch to that stored with the new Pattern when Patterns are switched.

Settings: off, on

NOTE The tempo setting data in the Pattern Chain is not affected by this parameter.

SongEventChase

Event Chase allows you to specify which non-note data types are properly recognized during fast-forward and rewind operations. Setting this to a specific event ensures the playback integrity of the event, even when fast forwarding or rewinding.

Settings: Off, PC (Program Change), PC+PB+Ctrl (Program Change + Pitch Bend + Control Change), all (All events)

Utility Mode

[F1] GENERAL

[F2] VOICE

▶ [F2] SEQ

[F3] VCE A/D

[F4] CTL ASN

[F5] USB I/O

[F6] MIDI

Utility Job

NOTE Keep in mind that settings other than “off” may result in slower operation—for example, a pause before starting playback, or slower rewind/fast forward speed.

NOTE When this is set to “all,” an excessive amount of MIDI data may be generated, possibly resulting in a MIDI error on the connected device.

LoadMix

Determines whether the Mixing settings are loaded (on) or not (off) when the Song/Pattern number is changed.

Settings: off, on

NOTE This setting affects the Song/Pattern changes during Song chain playback.

[SF6] MEMORY

Indicates the remaining free (available) memory for the Sequencer.

[F3] VCE A/D (Voice A/D Input)

You can set parameters related to the audio input signal from the A/D INPUT [L]/[R] jacks in the Voice mode. Details on each parameter are the same as in Performance Common Edit. See [page 62](#).

[F4] CTL ASN (Controller Assign)

[SF1] ASSIGN

Determines Controller Assign settings common to the entire system of the MOXF6/MOXF8. You can assign MIDI Control Change Numbers to the Knobs on the front panel and the external controllers. For example, you could use the ASSIGN 1 and 2 knobs to control effect depth for two different effects, while using the Foot Controller to control modulation. These Control Change Number assignments are known as “Controller Assign.”

NOTE As for controllers that are not actually available on the instrument itself, they can be controlled by transmitting the corresponding MIDI control number from an external MIDI controller.

BC (Breath Controller Control Number)

Determines the Control Change number generated when you use a Breath Controller on an external device connected to the MOXF6/MOXF8.

Settings: off, 1 – 95

RB (Ribbon Controller Control Number)

Determines the Control Change number corresponding to a Ribbon Controller on an external device connected to the MOXF6/MOXF8.

Settings: off, 1 – 95

FC1 (Foot Controller 1 Control Number)

Determines the Control Change number generated when you use the Foot Controller connected to the [FOOT CONTROLLER] jack. Keep in mind that if the same MIDI Control Change messages as set here are received from an external device, the internal tone generator also responds to those messages as if the Foot Controller of the instrument itself was used.

Settings: off, 1 – 95

FC2 (Foot Controller 2 Control Number)

Determines the Control Change number corresponding to a Foot Controller 2 on an external device connected to the MOXF6/MOXF8.

Settings: off, 1 – 95

AS1 (Assignable 1 Control Number)

AS2 (Assignable 2 Control Number)

Determines the Control Change number generated when you use the ASSIGN 1/2 knobs. Keep in mind that if the same MIDI Control Change messages as set here are received from an external device, the internal tone generator also responds to those messages as if the ASSIGN 1/2 knobs of the instrument itself was used.

Settings: off, 1 – 95

Utility Mode

[F1] GENERAL

[F2] VOICE

▶ [F2] SEQ

▶ [F3] VCE A/D

▶ [F4] CTL ASN

[F5] USB I/O

[F6] MIDI

Utility Job

AF1 (Assign Function 1 Control Number)
AF2 (Assign Function 2 Control Number)

Determines the Control Change number generated when you use the ASSIGNABLE FUNCTION [1]/[2] buttons. Keep in mind that if the same MIDI Control Change messages as set here are received from an external device, the internal tone generator also responds to those messages as if the ASSIGNABLE FUNCTION [1]/[2] buttons of the instrument itself was used.

Settings: off, 1 – 95

[SF2] FT SW (Foot Switch)

From this display you can determine the Control Change number generated by using the Footswitch connected to the FOOT SWITCH jack.

FS (Foot Switch Control Number)

From this display you can determine the Control Change number generated by using the Footswitch connected to the FOOT SWITCH [ASSIGNABLE] jack. Keep in mind that if the same MIDI Control Change messages as set here are received from an external device, the internal tone generator also responds to those messages as if the Footswitch of the instrument itself was used.

Settings: off, 1 – 95, arp sw, play/stop, PC inc, PC dec, octave reset

SustainPedal (Foot Switch Sustain Pedal Select)

Determines which model of an optional Foot Switch connected to the FOOT SWITCH [SUSTAIN] jack is recognized.

When the FC3 is used:

When you connect an optional FC3 (equipped with the half-damper feature) for producing the special “half-damper” effect (as on a real acoustic piano), set this parameter to “FC3 (Half on).” If you don’t need the half-damper feature or want to disable it while still using an FC3, set this parameter to “FC3 (Half off).”

When the FC4 or FC5 is used:

Select “FC4/5.” The FC4 and FC5 are not equipped with the half-damper feature.

Settings: FC3 (Half on), FC3 (Half off), FC4/5

NOTE Note that this setting is not necessary when controlling the half-damper feature via Control Change messages from an external MIDI device to the instrument.

Utility Mode

- [F1] GENERAL
- [F2] VOICE
- [F2] SEQ
- [F3] VCE A/D
- ▶ [F4] CTL ASN
- ▶ [F5] USB I/O
- [F6] MIDI

Utility Job

[F5] USB I/O

Mode

Determines the audio input/output connections. The following three settings are available.

Settings: VST, 2StereoRec, 1StereoRec

VST The audio signal from A/D INPUT [L]/[R] jacks is output to the “USB 1/2” channels of the USB TO [HOST] jack. Also, the audio signal from the tone generator is output to the “USB 3/4” channels of the USB TO [HOST] jack. This mode is for using the 2 stereo channels (4 channels) as the output channels. When using the MOXF6/MOXF8 Editor VST, set this parameter to “VST.”

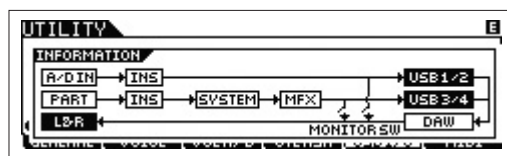

2StereoRec The audio signal from A/D INPUT [L]/[R] jacks is output to the “USB 1/2” channels of the USB TO [HOST] jack. Also, the audio signal from the tone generator is output to the “USB 1/2” channels or the “USB 3/4” channels of the USB TO [HOST] jack. The output channels for the audio signal from the A/D INPUT [L]/[R] is fixed, but the output channels for audio signal from the tone generator can be selected for each part. The output channel for each part is selected in “USB OUTPUT SELECT” of Performance Common Edit (page 61) or Mixing Common Edit (page 116).

NOTE In the Voice mode, the output channel for audio signal from the tone generator is fixed to “USB 3/4.”

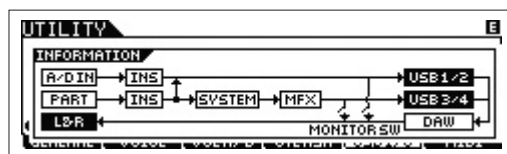

1StereoRec..... The audio signal from the A/D INPUT [L]/[R] jacks and the tone generator are output together to the "USB 1/2" channels of the USB TO [HOST] jack. This mode is for using the 1 stereo channels (2 channels) as output channels.

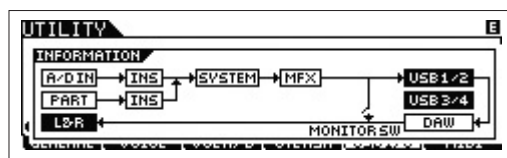

DirectMonitorSw A/D In&Part (Direct Monitor Switch A/D Input & Part)

Determines whether or not the audio signal which is output to the external device via the "USB 1/2" channels also sounds from this instrument (Direct Monitoring). When this is set to "on," the audio signal which is output via the "USB 1/2" channels is also output to the OUTPUT [L/MONO]/[R] jacks and [PHONES] jack. The audio signal output to "USB 1/2" channels varies depending on the "Mode" setting. When "Mode" is set to "VST," "DirectMonitorSw A/D In" is indicated in this parameter.

Settings: off, on

NOTE When the maximum number of output channels for USB is set to 2 channels, "Mode" is fixed to "1StereoRec." For details, see the [SF1] OUT CH display (page 147).

DirectMonitorSw Part (Direct Monitor Switch Part)

This parameter is shown only when "Mode" is set to "VST" or "2StereoRec." Determines whether or not the audio signal which is output to the external device via the "USB 3/4" channels also sounds from this instrument (Direct Monitoring). When this is set to "on," the audio signal which is output via the "USB 3/4" channels is also output to the OUTPUT [L/MONO]/[R] jacks and [PHONES] jack.

Settings: off, on

[SF1] OUT CH (Output Channel)

Pressing this button calls up the display which determines whether the maximum number of output channels for USB is 4 channels (2 stereo channels) or 2 channels (1 stereo channel). If transfer of the audio signal between the MOXF6/MOXF8 and the computer connected to the MOXF6/MOXF8 is compromised or impossible, set this parameter to "2ch." This setting reduces the CPU load of the computer, and may resolve the problem. After changing this setting, press the [ENTER] button, then restart the MOXF6/MOXF8.

NOTICE

After changing this setting and pressing the [ENTER] button, make sure to restart the MOXF6/MOXF8; the instrument will not operate otherwise. Before restarting, make sure to store any important edited data to prevent it from being inadvertently lost.



[SF6] INFO (Information)

Pressing this button calls up the display which indicates the illustration of the audio connection. You can confirm the "Mode" setting and "DirectMonitor Switch" setting here.

[F6] MIDI

[SF1] CH (Channel)

From this display you can make basic MIDI settings.

BasicRcvCh (Basic Receive Channel)

Determines the MIDI receive channel when this synthesizer is set to single-timbre tone generator mode (Voice/Performance modes).

Settings: 1 – 16, omni (all channels), off

NOTE In the multi-timbral tone generator mode (Song/Pattern modes), each Part receives MIDI data according to its assigned MIDI receive channel ([SONG] or [PATTERN]) → [MIXING] → [EDIT] → Part selection → [F1] VOICE → [SF2] MODE → ReceiveCh.

Utility Mode

[F1] GENERAL

[F2] VOICE

[F2] SEQ

[F3] VCE A/D

[F4] CTL ASN

▶ [F5] USB I/O

▶ [F6] MIDI

Utility Job

KBDTransCh (Keyboard Transmit Channel)

Determines the MIDI channel over which the instrument sends MIDI data (to an external sequencer, tone generator, or other device). This parameter is available in the single-timbre tone generator mode (Voice/Performance modes).

Settings: 1 – 16, off

NOTE In the multi-timbral tone generator mode (Song/Pattern modes), MIDI data generated by playing the keyboard (and its controllers) is sent to the internal tone generator and external devices via the MIDI output channel, set from the CHANNEL display ([SONG] or [PATTERN] → [F3] TRACK → [SF1] CHANNEL).

DeviceNo. (Device Number)

Determines the MIDI Device Number. This number must match the Device Number of the external MIDI device when transmitting/receiving bulk data, parameter changes or other system exclusive messages.

Settings: 1 – 16, all, off

[SF2] SWITCH

BankSel (Bank Select)

This switch enables or disables Bank Select messages, both in transmission and reception. When this is set to “on,” this synthesizer responds to incoming Bank Select messages, and it also transmits appropriate Bank Select messages (when using the panel).

Settings: off, on

PgmChange (Program Change)

This switch enables or disables Program Change messages, both in transmission and reception. When this is set to “on,” this synthesizer responds to incoming Program Change messages, and it also transmits appropriate Program Change messages (when using the panel).

Settings: off, on

LocalCtrl (Local Control)

This determines whether or not the tone generator of the instrument responds to your keyboard playing. Normally, this should be set to “on” — since you’ll want to hear the sound of the MOXF6/MOXF8 as you play it. Even if this is set to “off,” the data will be transmitted via MIDI. Also, the internal tone generator block will respond to messages received via MIDI.

Settings: off (disconnect), on (connect)

RcvBulk (Receive Bulk)

Determines whether or not Bulk Dump data can be received.

Settings: protect (not received), on (received)

[SF3] SYNC (Synchronization)

From this display you can set various parameters related to MIDI clock and synchronization.

MIDI Sync

Determines whether Song/Pattern/Arpeggio playback will be synchronized to the instrument’s internal clock or an external MIDI clock.

Settings: internal, external, auto, MTC

- internal.....Synchronization to internal clock. You can use this setting when this tone generator is to be used alone or as the master clock source for other equipment.
- external.....Synchronization to a MIDI clock received from an external MIDI instrument via MIDI. Use this setting when the external sequencer is to be used as master.
- auto.....When MIDI clock is transmitted continuously from an external MIDI device or computer, the internal clock of the MOXF6/MOXF8 is automatically disabled and the MOXF6/MOXF8 is synchronized with the external clock. When MIDI clock is not transmitted from the external MIDI device or computer, the internal clock of the MOXF6/MOXF8 continues to run in sync with the latest received tempo of the external MIDI device or computer (DAW software). This setting is useful when you wish to alternate between external clock and internal clock.
- MTC (MIDI Time Code)Synchronization to an MTC signal received via MIDI. MMC signals are transmitted via MIDI. Use this setting when this synthesizer is to be used as a MIDI slave, such as when synchronized to an MTC-capable MTR. The MTC Sync function is available only in the Song mode.

NOTE When MIDI Sync is set to “MTC,” Songs and Arpeggios cannot play back in the Song mode but Patterns and Arpeggios can play back in the Pattern mode.

NOTE MTC (MIDI Time Code) allows simultaneous synchronization of multiple audio devices via standard MIDI cables. It includes data corresponding to hours, minutes, seconds, and frames. The MOXF6/MOXF8 does not transmit MTC.

NOTE MMC (MIDI Machine Control) allows remote control of multi Track recorders, MIDI sequencers, etc. A MMC-compatible multi Track recorder, for example, will automatically respond to start, stop, fast forward, and fast reverse operations performed on the controlling sequencer, thus keeping playback of the sequencer and multi Track recorder aligned.

Utility Mode

[F1] GENERAL

[F2] VOICE

[F2] SEQ

[F3] VCE A/D

[F4] CTL ASN

[F5] USB I/O

[F6] MIDI

Utility Job

NOTE When setting the MOXF6/MOXF8 so that Arpeggio playback is synchronized to an external MIDI clock, make sure to set the devices so that the MIDI clock from the DAW software/ external MIDI device is properly transmitted to the MOXF6/MOXF8 from the DAW software/ external MIDI devices.

ClockOut

Determines whether MIDI clock (F8) messages will be transmitted via the MIDI OUT/USB terminal.

Settings: off, on

SeqCtrl (Sequencer Control)

Determines whether Sequencer Control signals — start, continue, stop, and song position pointer — will be received and/or transmitted via MIDI.

Settings: off, in, out, in/out
 off..... Not transmitted/recognized.
 in..... Recognized, but not transmitted.
 out..... Transmitted, but not recognized.
 in/out..... Transmitted/recognized.

MTC StartOffset

Determines the specific time code point from which sequence playback starts, when MTC is received. This feature can be used to accurately align playback of this synthesizer with an external MTC-compatible device.

Settings: Hour: Minute: Second: Frame
 Hour: 00 – 23
 Minute: 00 – 59
 Second: 00 – 59
 Frame: 00 – 29

[SF4] OTHER

MIDI IN/OUT

Determines which physical output/input terminal(s) will be used for transmitting/receiving MIDI data.

Settings: MIDI, USB

NOTE The two types of terminals above cannot be used at the same time. Only one of them can be used to transmit/receive MIDI data.

BulkInterval

Determines the interval time of the Bulk Dump transmission when the Bulk Dump function is used or the Bulk Dump Request is received.

Settings: 0 – 900 ms

Utility Mode

[F1] GENERAL

[F2] VOICE

[F2] SEQ

[F3] VCE A/D

[F4] CTL ASN

[F5] USB I/O

▶ [F6] MIDI

Utility Job

Utility Job

In the Utility Job mode, you can restore this synthesizer's User memory (page 23) to the factory default settings (Factory Set). Please note that the setting of "Power On Auto" on this display will be stored automatically by executing Factory Set.

NOTICE

When the factory settings are restored, all the Voice, Performance, Song, Pattern, and system settings in the Utility mode you created will be erased. Therefore, you should be careful not to overwrite irreplaceable data. Furthermore, it is wise to regularly create backup copies of important Performance data and system settings to a USB flash-memory device, computer, or the like.

NOTE For instructions on executing Factory Set, see the Owner's Manual.

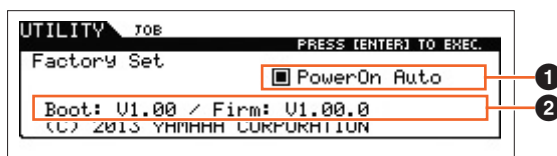

1 PowerOn Auto (Power On Auto Factory Set)

When this parameter is set to on, turning the power on will restore the User memory to the factory default settings and load the demo Songs and demo Patterns. Normally, this should be set to off.

Settings: on, off

NOTICE

When setting Auto Factory Set to "on" and executing Factory Set, the Factory Set function will automatically be executed each time you turn the power on. When setting the Auto Factory Set parameter to off and pressing the [ENTER] button, the Factory Set will not be executed when turning the power on the next time.

2 Version

Indicates the current version of this instrument.

Utility Mode

[F1] GENERAL

[F2] VOICE

[F2] SEQ

[F3] VCE A/D

[F4] CTL ASN

[F5] USB I/O

[F6] MIDI

Utility Job

Quick Setup

Using Quick Setup can instantly call up appropriate sequencer-related panel settings by selecting convenient preset setups, allowing you to simultaneously and instantly set a variety of important sequencer-related parameters.

Operation

Press the [QUICK SETUP] button.

Quick Setup

[F1] SETUP

[F2] AUDIO

[F3] MIDI

[F1] SETUP

This display determines the six Quick Setup settings. This display consists of two pages. Three Quick Setup settings are shown in each page. Use the cursor [^]/[V] buttons to switch between the pages. After completing the settings as desired, select the particular Quick Setup you want to use and then press the [ENTER] button to execute the setup.

NOTE Holding the [QUICK SETUP] button and pressing the appropriate [A] (1) – [F] (6) buttons can also execute the corresponding Quick Setup.

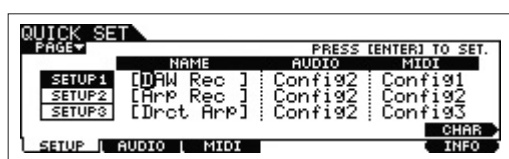

1 NAME

Determines the name for each Quick Setup.

2 AUDIO

Selects the audio setting for each Quick Setup. Each audio setting ("Config1" – "Config6") can be edited in the [F2] AUDIO display.

Settings: Config1 – Config6

3 MIDI

Selects the MIDI setting for each Quick Setup. Each MIDI setting ("Config1" – "Config6") can be edited in the [F3] MIDI display.

Settings: Config1 – Config6

The default settings for Quick Setups 1 – 6 are as follows.

Quick Setup 1 (DAW Rec)

■ "Audio" = "Config2"

Use this setting when recording the signals from the tone generator and the A/D INPUT [L]/[R] jacks separately to DAW software, and playing the signals from the OUTPUT [L/MONO]/[R] jacks directly.

Mode	DirectMonitorSw A/D In	DirectMonitorSw Part
2StereoRec	on	on

■ "MIDI" = "Config1"

Use this setting when recording this instrument's performance (not including Arpeggio data) to the DAW software.

LocalCtrl	MIDI Sync	ClockOut	ArpOutSw	KBDTransCh	TrIntSw	TrExtSw
off	auto	off	all off	1	all on	all on

Quick Setup 2 (Arp Rec)

■ "Audio" = "Config2"

This setting is same as the Quick Setup 1.

■ "MIDI" = "Config2"

Use this setting when recording this instrument's performance including Arpeggio data to the DAW software. Keep in mind that this is for recording Arpeggios for which "KeyMode" is set to "sort" or "thru."

LocalCtrl	MIDI Sync	ClockOut	ArpOutSw	KBDTransCh	TrIntSw	TrExtSw
on	auto	off	all on	off	all on	all off

Quick Setup 3 (Drct Arp)

- "Audio" = "Config2"

This setting is same as Quick Setup 1.

- "MIDI" = "Config3"

Use this setting when recording this instrument's performance including Arpeggio data to the DAW software. Keep in mind that this is for recording Arpeggios for which "KeyMode" is set to "direct," "sortdirect," or "thrudirect."

LocalCtrl	MIDI Sync	ClockOut	ArpOutSw	KBDTransCh	TrIntSw	TrExtSw
on	auto	off	all on	1	all on	all on

Quick Setup 4 (St Alone)

- "Audio" = "Config2"

This setting is same as Quick Setup 1.

- "MIDI" = "Config4"

Use this setting when this instrument is to be used alone or as the master clock source for other equipment.

LocalCtrl	MIDI Sync	ClockOut	ArpOutSw	KBDTransCh	TrIntSw	TrExtSw
on	internal	on	all off	1	all on	all on

Quick Setup 5 (VST Rec)

- "Audio" = "Config4"

Use this setting when using the MOXF6/MOXF8 Editor VST to record MIDI data to the DAW software.

Mode	DirectMonitorSw A/D In	DirectMonitorSw Part
VST	On	On

- "MIDI" = "Config1"

This setting is same as Quick Setup 1.

Quick Setup 6 (VST Play)

- "Audio" = "Config1"

Use this setting when using the MOXF6/MOXF8 Editor VST to play this instrument sound on the DAW software.

Mode	DirectMonitorSw A/D In	DirectMonitorSw Part
VST	On	off

- "MIDI" = "Config1"

This setting is same as Quick Setup 1.

Quick Setup

- ▶ [F1] SETUP
- ▶ [F2] AUDIO
- ▶ [F3] MIDI

[F2] AUDIO

Determines the audio signal settings for the selected Config. These settings are same as in the [F5] USB I/O display (page 146) in the Utility mode. To switch among Config 1 – 6, use the [SF1] – [SF6] buttons.

[F3] MIDI

Determines the parameters related to the connections to an external MIDI device. The function of each editable parameter is same as the following parameters. To switch among Config 1 – 6, use the [SF1] – [SF6] buttons.

LocalCtrl (Local Control)

Utility mode → [F6] MIDI → [SF2] SWITCH → "LocalCtrl" (page 148)

MIDI Sync

Utility mode → [F6] MIDI → [SF2] SYNC → "MIDI Sync" (page 148)

ClockOut

Utility mode → [F6] MIDI → [SF2] SYNC → "ClockOut" (page 149)

TrIntSw (Track Internal Switch)

Song /Pattern mode → [F3] TRACK → [SF2] OUT SW → "INT SW" (page 78)

TrExtSw (Track External Switch)

Song /Pattern mode → [F3] TRACK → [SF2] OUT SW → "EXT SW" (page 78)

ArpOutSw (Arpeggio Output Switch)

Performance/Song/Pattern mode → ARP [EDIT] → [F6] OUT CH → "OutputSwitch" (page 58)

KBDTransCh (Keyboard Transmit Channel)

Utility mode → [F6] MIDI → [SF1] CH → "KBDTransCh" (page 148)

File Mode

The File mode provides tools for transferring data (such as Voice, Performance, Song, Pattern, and Waveform) between the MOXF6/MOXF8 and external storage devices such as USB flash memory or a hard disk unit connected to the USB [TO DEVICE] terminal.

Operation

Press the [FILE] button.

Terminology in the File mode

File

The term "file" is used to define a collection of data stored on a USB flash memory device or a hard disk drive of a computer. Just as with a computer, various data types such as Voice, Performance, Song and Pattern created on the MOXF6/MOXF8 can be treated as a file and saved to a USB flash memory device. Each file has a file name and a file extension.

File Name

Just as with a computer, you can assign the name to the file in the File mode. The file name can contain up to eight alphabetical characters on the display of the MOXF6/MOXF8. Files having the same name cannot be saved in the same directory.

Extension

The three letters following the file name (after the period) such as ".mid" and ".wav" are referred to as a file "extension." The extension indicates the type of file and cannot be changed by panel operations on the MOXF6/MOXF8. The file mode of the MOXF6/MOXF8 supports different extension types, according to the particular data.

File Size

This refers to the memory amount of the file. The file size is determined by the amount of data saved to the file. File sizes are indicated in conventional computer terms by B (byte), KB (kilobyte), MB (megabyte) and GB (gigabyte). 1KB is equivalent to 1024 bytes, 1MB is equivalent to 1024KB, and 1GB is equivalent to 1024MB.

Storage

Refers to a memory storage unit (such as a hard disk) to which the file is saved. This instrument can handle and mount various USB flash memory devices connected to the USB [TO DEVICE] terminal.

Directory (Dir)

This is an organizational feature on a data storage device (such as hard disk), allowing you to group data files together according to type or application. Directories can be nested in hierarchical order for organizing data. In this regard, a "directory" is equivalent to a folder as used on a computer. The File mode of the MOXF6/MOXF8 allows you to assign a name to a directory just as with a file. Please note that the directory name does not contain an extension.

Hierarchical Structure (Tree Structure)

If you've saved a large number of files to memory or hard disk, you'll want to organize those files into proper folders. Also, if you have a large number of files and folders, you'll want to organize those folders into a hierarchical structure, where multiple folders are grouped into relevant 'parent' folders, and so on. The very top location for all your folders (which is called up when you first open the memory location or hard disk) is called the "root directory."

Changing the current directory (folder)

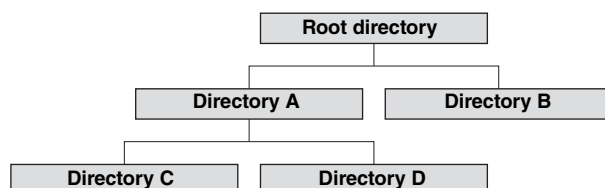

Using the illustration above as an example, this shows you how to change the current directory. First, open the root directory to find directories A and B. Next, open directory A to find directories C and D. Finally, open directory C to find only the files saved in directory C. This allows you to call up folders nested down in the lower levels of the folder hierarchy. To select a different directory higher up (for example, moving from directory C to directory B), first go to the

File Mode

[F1] CONFIG

[F2] SAVE

[F3] LOAD

[F4] RENAME

[F5] DELETE

[F6] FLASH

Supplementary Information

next highest level (directory A). Next, go up one more level (to the root directory). Now that both A and B are available, open directory B. In this way you can move up or down as desired through the folder hierarchy.

Path

The location of the directories (folders) and files currently indicated at the "Dir" line on the display is referred to as a "path." This indicates the current directory, which device it belongs to, and in which folder(s) it is contained. "Directory C" illustrated above is described as path "USB_HDD/A/C."

Mount

Refers to the operation that enables an external memory device for use with the instrument. A USB flash memory device is automatically mounted as soon as it is connected to the USB [TO DEVICE] terminal on the rear panel of the MOXF6/MOXF8. The reverse procedure (removing) is called "Unmount."

Format

The operation of initializing a storage device (such as a hard disk) is referred to as "format." The format operation erases all data from the target memory device and is irreversible.

Save/Load

"Save" means that the data created on the MOXF6/MOXF8 is saved to the USB flash memory as a file, while "Store" means that the data created on the MOXF6/MOXF8 is stored to internal memory. "Load" means that the file on the USB flash memory is loaded to internal memory.

[F1] CONFIG (Configuration)

[SF1] CURRENT

Indicates the currently recognized flash memory device.

USB Device

Status Free

Indicates the amount of free capacity for the currently recognized USB flash memory device.

Status Total

Indicates the amount of total memory for the currently recognized USB flash memory device.

Expansion Module

Unmounted

Unformatted

Formatted

Indicates the status for the currently recognized Flash memory expansion module (optional).

Status Free

Indicates the amount of free memory capacity for the currently recognized Flash memory expansion module (optional).

Status Total

Indicates the amount of total memory for the currently recognized Flash memory expansion module (optional).

[SF2] FORMAT

Formats the USB flash memory device connected to the instrument. Before you can use a new USB flash memory device with the MOXF6/MOXF8, you will need to format it. For instructions on formatting, see [page 161](#).

Volume Label

Determines the name of the Volume Label. The name can contain up to eleven characters, and is entered by using the [DATA] dial and cursor [←]/[→] buttons. Pressing the [SF6] button calls up the character list for entering the name. For detailed instructions on naming, see the "Basic Operation" of the Owner's Manual.

Free

Indicates the amount of free/total memory for the currently recognized USB flash memory device.

File Mode

[F1] CONFIG

[F2] SAVE

[F3] LOAD

[F4] RENAME

[F5] DELETE

[F6] FLASH

Supplementary Information

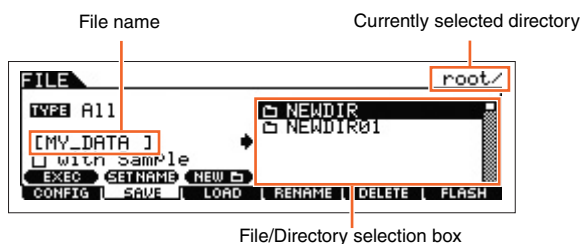
[F2] SAVE**File Mode**

[F1] CONFIG

▶ [F2] SAVE

[F3] LOAD

[F4] RENAME

[F5] DELETE

[F6] FLASH

Supplementary Information

This operation lets you save files to a USB flash memory device. For specific operating procedures, see the Owner's Manual.

TYPE

Among the various types of data created on this synthesizer, you can save all of them or only a specific type of data to a single file. This parameter determines which specific type of data will be saved to a single file.

Settings: The file types which can be saved are as follows.

File types	Extension	Descriptions
All	.X6A	All data in this synthesizer's internal User Memory (Flash ROM) is treated as a single file, and can be saved to USB flash memory. Also the Waveforms assigned to any of the Voices are saved together.
AllVoice	.X6V	All the User Voice data in this synthesizer's internal User Memory (Flash ROM) is treated as a single file, and can be saved to USB flash memory. However, the Mixing Voice cannot be saved. Also the Waveforms assigned to any of the Voices are saved together.
AllArp (All Arpeggio)	.X6G	All the User Arpeggio data in this synthesizer's internal User Memory (Flash ROM) is treated as a single file, and can be saved to USB flash memory.
AllSong	.X6S	All the User Song data in this synthesizer's internal User Memory (Flash ROM) is treated as a single file, and can be saved to USB flash memory. The Song data includes Mixing settings and Mixing Voices.
AllPattern	.X6P	All the User Pattern data in this synthesizer's internal User Memory (Flash ROM) is treated as a single file, and can be saved to USB flash memory. The Pattern data includes Mixing settings and Mixing Voices.
SMF (Standard MIDI File)	.MID	Sequence Track (1 – 16) and Tempo Track data of Songs or Patterns created in the Song/Pattern mode can be saved to USB flash memory as Standard MIDI File (format 0) data.
AllWaveform	.X6W	All the Waveform data can be saved as a single file. The Waveform data includes all the Samples on the optional Flash Memory Expansion Modules (FL512M/FL1024M). Note that the Samples on the FL512M/FL1024M may not be included in a file of this type because you can select whether or not these are to be saved before executing the Save operation.

NOTE When the "with Sample" check box is marked, Sample data is also saved to the USB flash memory.

[SF1] EXEC (Execute)

Pressing this button saves the file to the currently selected directory.

NOTE To open the selected directory, press the [ENTER] button.

[SF2] SET NAME

Pressing this button copies the file/directory name selected at the file/directory selection box to the file name location.

[SF3] NEW

Pressing this button creates a new directory in the current directory.

[F3] LOAD

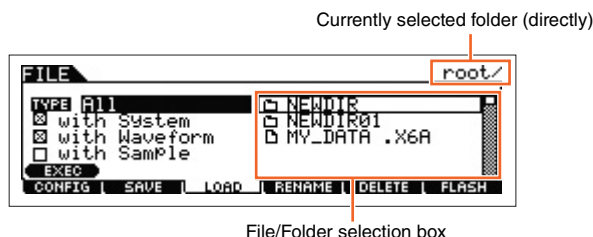

This operation lets you load files from a USB flash memory device to this synthesizer. You can also perform on the keyboard while playing backing parts from an SMF file contained in the USB flash memory. For details, see [page 160](#).

TYPE

Among the various types of data saved in a single file on a USB flash memory, you can load all of them to this synthesizer at once or only a specific, desired type of data. This parameter determines which specific type of data will be loaded from a single file.

Settings: The file types which can be loaded are as follows.

File Types	Extension*	Descriptions
All	.X6A	Files of the "All" type saved to USB flash memory can be loaded and restored to the instrument. When "All" is selected as a file type to be loaded, "☑ with System" appears in the display. If this box is unchecked and the Load is executed, all data with the exception of the system settings in the Utility mode is loaded.
AllVoice	.X6V	Files of the "AllVoice" type saved to USB flash memory can be loaded and restored to the instrument.
1BankVoice	.X6A .X6V	The Voices in the selected Bank of the file saved as an "All"/"AllVoice" type can be loaded. Please note that the file icons of "X6A" and "X6V" are changed to (as virtual folders) when this file type is selected. When selecting this file and then pressing the [ENTER] button, the Voice Bank list of the file and the load destination are indicated. Select the source Voice Bank for loading in the box located at the right of the display.
Voice	.X6A .X6V	A specified Voice in a file that is saved to USB flash memory as an "All" or "All Voice" type can be individually selected and loaded to the instrument. Please note that the file icons of "X6A" and "X6V" are changed to (as virtual folders) when this file type is selected. When selecting this file type and then pressing the [ENTER] button, the Voice Bank list of the file is indicated. When selecting the Bank and then pressing the [ENTER] button, the Voice list of the selected Bank and the load destination are indicated. Select the source Voice for loading in the box located at the right of the display, and select the destination Voice for loading at the left of the display.
1BankPerform	.X6A	The Performances in the selected Bank of the file saved as an "All" can be saved. Please note that the file icons of "X6A" are changed to (as virtual directories) when this file type is selected. When selecting this file and then pressing the [ENTER] button, the Performance Bank list of the file and the load destination are indicated. Select the source Performance Bank for loading in the box located at the right of the display, and select the destination Performance Bank for loading at the left of the display.
Performance	.X6A	A specified Performance in a file that is saved to USB flash memory as an "All" type can be individually selected and loaded to the instrument. Please note that the file icons of "X6A" are changed to (as virtual directories) when this file type is selected. When selecting this file and then pressing the [ENTER] button, the Performance Bank list of the file is indicated. When selecting the Bank and then pressing the [ENTER] button, the Performance list of the selected Bank and the load destination are indicated. Select the source Performance for loading in the box located at the right of the display, and select the destination Performance for loading at the left of the display.
AllArp (All Arpeggio)	.X6G	Files of the "AllArp" type saved to the USB flash memory can be loaded and restored to the instrument.
AllSong	.X6S	Files of the "AllSong" type saved to the USB flash memory can be loaded and restored to the instrument.
Song	.X6A .X6S .MID	A specified Song in a file that is saved to the USB flash memory as an "All" or "All Song" type can be individually selected and loaded to the instrument. Please note that the file icons of "X6A" or "X6S" are changed to (as virtual directories) when this file type is selected. When selecting this file and then pressing the [ENTER] button, the Song list of the file and the load destination are indicated. Select the source Song for loading in the box located at the right of the display, and select the destination Song for loading at the left of the display. In addition, selecting this file type lets you load Standard MIDI files (format 0, 1) to a specific Song.
AllPattern	.X6P	Files of the "AllPattern" type saved to USB flash memory can be loaded and restored to the instrument.

File Mode

[F1] CONFIG

[F2] SAVE





▶ [F3] LOAD

[F4] RENAME

[F5] DELETE

[F6] FLASH

Supplementary Information

File Types	Extension*	Descriptions
Pattern	.X6A .X6P .MID	A specified Pattern in a file that is saved to the USB flash memory as an "All" or "AllPattern" type can be individually selected and loaded to the instrument. Please note that the file icons  of "X6A" and "X6P" are changed to  (as virtual directories) when this file type is selected. When selecting this file and then pressing the [ENTER] button, the Pattern list of the file and the load destination are indicated. Select the source Pattern for loading in the box located at the right of the display, and select the destination Pattern at the left of the display. In addition, selecting this file type lets you load a Standard MIDI file (format 0, 1) to a specific Section of a Pattern.
AllWaveform	.X6W	Files of the "All Waveform" types saved to the USB storage device can be loaded and restored to the instrument.
Waveform	.X6A .X6W .WAV .AIF	A specified Waveform in a file that is saved to the USB storage device as "All" or "All Waveform" type can be individually selected and loaded to the instrument. Please note that the file icons  of "X6A" and "X6W" are changed to  (as virtual folders) when this file type is selected.

* Assigned to the file which can be loaded.

NOTE When the "with Waveform" check box is marked, Waveform data is also loaded to the Flash Memory Expansion Module.

NOTE When the "with Sample" check box is marked, Sample data is also loaded to the Flash Memory Expansion Module.

Data Compatibility with the MOX6/MOX8

Among the data created on the MOX6/MOX8, the following can be loaded to the MOXF6/MOXF8.

Type of MOX	File extension of MOX
All	.X4A
AllVoice	.X4V
AllArp	.X4G
AllSong	.X4S
AllPattern	.X4P

Data Compatibility with the MOTIF XF6/MOTIF XF7/MOTIF XF8

Among the data created on the MOTIF XF6/MOTIF XF7/MOTIF XF8, the following can be loaded to the MOXF6/MOXF8.

Type of MOTIF XF	File extension of MOTIF XF
All	.X3A *1
AllVoice	.X3V
AllArp	.X3G
AllSong	.X3S *2
AllPattern	.X3P *2
AllWaveform	.X3W

*1: Only Voice, Performance, Arpeggio, Mix Template, and Waveform data.

*2: Only Waveform data.

[SF1] EXEC (Execute)

Loads the selected file.

NOTE To enter the selected directory or select the desired Bank of the Voice/Performance/Waveform, press the [ENTER] button.

File Mode

[F1] CONFIG

[F2] SAVE

[F3] LOAD

[F4] RENAME

[F5] DELETE

[F6] FLASH

Supplementary Information

[F4] RENAME

Select the desired file type.

Select the file/folder to be renamed.



Rename the selected file/folder here.

Rename the selected file/directory here. You can rename files using up to eight alphabetic and numeric characters. Files are named according to MS-DOS naming conventions. If the file name contains spaces and other characters unrecognized in MS-DOS, these characters will automatically be replaced by "_" (underscore) characters when saving.

[SF1] EXEC (Execute)

Rename the selected file.

NOTE To open the selected directory, press the [ENTER].

[SF2] SET NAME

Pressing this button copies the file/directory name selected at the file/directory selection box to the file name location.

[SF3] NEW

Pressing this button creates a new directory in the current directory.

[F5] DELETE

Select the desired file type.

Select the file or directory to be deleted.



From this display you can delete files/directories from the selected USB flash memory device. Select the desired file or folder as shown above, then press the [SF1] EXEC button.

NOTE When you wish to delete a directory, delete all the files contained in the directory beforehand. Please keep in mind that only folders that contain no files or other nested directories can be deleted.

[F6] FLASH**[SF1] FORMAT**

Use this function to format an optional Flash Memory Module. Since the FL512M/1024M is not formatted when the unit is shipped from the factory, it is necessary to execute the Format operation. After installing a new Module, press the [ENTER] button to call up the confirmation dialog, then press the [ENTER] button again to execute the Format operation.

NOTICE

The Format operation can be applied to a Module which has already been formatted. In this case, note that all existing Waveform data will be erased.

File Mode

[F1] CONFIG

[F2] SAVE

[F3] LOAD

▶ [F4] RENAME

▶ [F5] DELETE

▶ [F6] FLASH

Supplementary Information

[SF2] DELETE

Use this function to delete a single Waveform. Select the Waveform, then press the [ENTER] button to delete the selected Waveform.

NOTE When entering this function from Voice mode, you can monitor the selected Waveform by playing the keyboard.

[SF3] OPTIMIZE

Use this function to optimize the Flash Expansion Memory Module. Optimization consolidates areas of used and unused (available) memory to create the largest possible area of contiguous available memory and speed up memory access. Press the [ENTER] button to call up the confirmation dialog, then press the [ENTER] button again to execute the Optimize operation.

■ NOTICE ■

Never turn off the power during the Optimize operation, which may require far more than ten minutes to finish. Doing so will erase and clear the data on the Flash Expansion Memory Module.

File Mode

[F1] CONFIG

[F2] SAVE

[F3] LOAD

[F4] RENAME

[F5] DELETE

▶ [F6] FLASH

Supplementary Information

Supplementary Information

■ File/Folder selection

The illustrations and instructions below show you how to select files and directories on a USB flash memory device within the File mode.

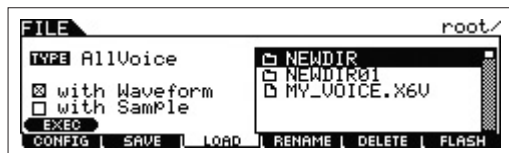

To return to the next highest level, press the [EXIT] button.  ↑  To go to the next lowest level, highlight the desired directory and press the [ENTER] button.

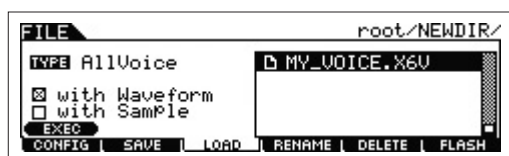

Select the directory or file by using the [DATA] dial and [INC]/[DEC] buttons.

■ Playing back a SMF (Standard MIDI file) from USB flash memory

In the File mode, you can directly play back a SMF file saved in a USB flash memory device. This function is convenient in live performance, since it lets you easily use SMF data as accompaniment while you play the keyboard.

- 1 Connect the USB flash memory including the SMF file device to this instrument.
- 2 Enter the Song mode or Pattern mode, then select the desired Song or Pattern.
- 3 Press the [FILE] button to enter the File mode.
- 4 Press the [F3] LOAD button to call up the Load display.
- 5 Move the cursor to "TYPE," then select the "Song" or "Pattern."



- 6 Select the SMF file.

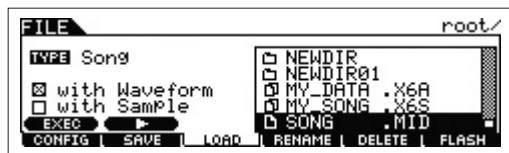

- 7 Press the [F6] ► (Play) button to play back the SMF file with the Mixing settings of the currently selected Song or Pattern. Press the [SF2] ■ (Stop) button again to stop playback.
- 8 Try playing the keyboard along with the accompaniment of the SMF file.

File Mode

[F1] CONFIG

[F2] SAVE

[F3] LOAD

[F4] RENAME

[F5] DELETE

[F6] FLASH

Supplementary Information

■ Formatting a USB flash memory device

Before you can use a new USB flash memory device with this instrument, you will need to format it. The correct way to format such a device is as follows.

■ NOTICE ■

If data is already saved to the USB flash memory device, be careful not to format it. If you format the device, all previously recorded data will be deleted. Make sure to check beforehand whether or not the device contains important data.

- 1 Connect a USB flash memory device to the USB [TO DEVICE] terminal.
- 2 Press the [FILE] button to enter the File mode.
- 3 Press the [F1] CONFIG button, then the [SF2] FORMAT button to call up the Format display.



4 Set the Volume Label.

Move the cursor to the "Volume Label" and input a Volume Label (up to 11 characters) by using the [DATA] dial and cursor [<]/[>] buttons. Pressing the [SF6] button calls up a character list for easy entry.

5 Press the [ENTER] button. (The display prompts you for confirmation.)

Press the [EXIT] button to cancel the Format operation.

6 Press the [ENTER] to button execute the Format operation.

After formatting has been completed, a "Completed" message appears and operation returns to the original display.

■ NOTICE ■

While formatting is in process, make sure to follow these precautions:

- Never remove or eject the USB flash memory from the device.
- Never unplug or disconnect any of the devices
- Never turn off the power of the MOXF6/MOXF8 or the relevant devices.

NOTE By executing the Format operation in the File mode, the USB flash memory device will be formatted to MS-DOS or Windows format. The formatted device may not be compatible with other devices, such as a Mac computer or digital camera.

File Mode

[F1] CONFIG

[F2] SAVE

[F3] LOAD

[F4] RENAME

[F5] DELETE

[F6] FLASH

Supplementary Information

Using iOS Applications

You can use various iOS applications with this instrument by connecting to an iPad, iPhone or iPod touch device via the optional i-MX1/i-UX1 MIDI interface—giving you even greater enjoyment and musical versatility. For details how to connect this instrument to the iPad/iPhone/iPod touch, refer to the i-MX1/i-UX1 Owner's Manual. Also, for information on compatible

applications and details on minimum requirements for the applications, refer to the following web site.

<http://www.yamaha.com/kbdapps/>

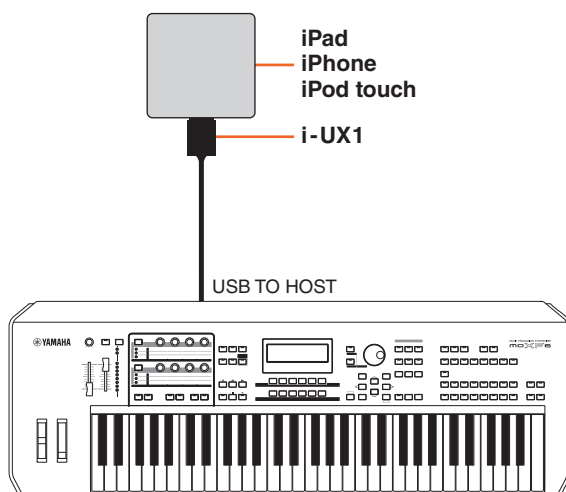
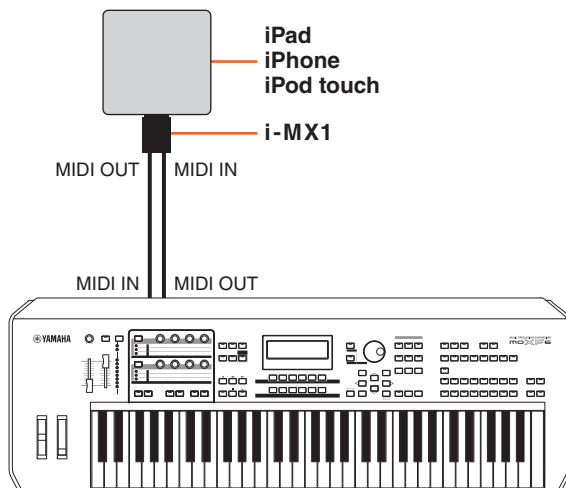

NOTE When you use the instrument along with the application on your iPhone/iPad, we recommend that you set "Airplane Mode" to "ON" on your iPhone/iPad in order to avoid noise caused by communication.

NOTE iOS applications may not be supported in your area. Please check with your Yamaha dealer.

Basic Structure

Functional blocks

Tone Generator block

A/D Input block

Sequencer block

Arpeggio block

Controller block

Effect block

Internal memory

Reference

Voice mode

Performance mode

Song mode

Pattern mode

Mixing mode

Master mode

Remote mode

Utility mode

Quick setup

File mode

Using iOS Applications

Appendix

MIDI

Appendix

About MIDI

MIDI is an acronym that stands for Musical Instrument Digital Interface, which allows electronic musical instruments to communicate with each other, by sending and receiving compatible Note, Control Change, Program Change and various other types of MIDI data, or messages. This synthesizer can control other MIDI devices by transmitting note related data and various types of controller data. It can also be controlled by incoming MIDI messages which automatically determine the tone generator mode, select MIDI channels, voices and effects, change parameter values, and of course play the voices specified for the various Parts. For detailed information of the MIDI messages that can be handled by the MOXF6/MOXF8, see the "Data List" PDF document. For details on MIDI, see the "Synthesizer Parameter Manual" PDF document. This section explains only information specific to the MOXF6/MOXF8.

• Channel Mode Messages

Reset All Controllers (Control No. 121)

The following parameters are affected:

ControllerSet	Disabled
LFOBoxSet	Disabled
Pitch Bend	64
Aftertouch	0 (off)
Modulation	0 (off)
Expression	127 (Max)
Sustain	0 (off)
Sostenuto	0 (off)
Portamento	Cancels the Portamento source key number
Foot Controller	127
Ribbon Controller	64
Breath Controller	127
Assign Knob	64
Assign Switch	0
RPN	Number not specified; internal data will not be changed.
NRPN	

Basic Structure

Functional blocks

Tone Generator block

A/D Input block

Sequencer block

Arpeggio block

Controller block

Effect block

Internal memory

Reference

Voice mode

Performance mode

Song mode

Pattern mode

Mixing mode

Master mode

Remote mode

Utility mode

Quick setup

File mode

Using iOS Applications

Appendix

▶ MIDI

Yamaha Web Site (English)
<http://www.yamahasyth.com/>
Yamaha Downloads
<http://download.yamaha.com/>

C.S.G., Digital Musical Instruments Division
© 2013 Yamaha Corporation
305MW-A0