



INTERNAL  
E-IDE/ATAPI  
International

English

Deutsch

Français

Español

# CD-R/RW Drive **CRW-F1**

OWNER'S MANUAL  
BEDIENUNGSANLEITUNG  
MODE D'EMPLOI  
MANUAL DE INSTRUCCIONES



*Advanced*  
**AudiOMASTER**  
QUALITY RECORDING

**DiscT@2**  
TM

**SafeBurn**  
TM

COMPACT  
**disc**  
ReWritable High Speed

# FCC INFORMATION

## **COMPLIANCE INFORMATION STATEMENT**

(DECLARATION OF CONFORMITY PROCEDURE)

Responsible Party: Yamaha Electronics Corporation, USA.  
Address: 6660 Orangethorpe Avenue  
Buena Park, CA 90620  
Telephone: 714-522-9105  
Fax: 714-670-0108  
Type of Equipment: CD Recordable/Rewritable Drive  
Model Name: CRW-F1  
CRW-F1-NB

This device complies with Part 15 of the FCC Rules.

Operation is subject to the following conditions:

- 1) this device may not cause harmful interference, and
- 2) this device must accept any interference received including interference that may cause undesired operation.

See user manual instructions if interference to radio reception is suspected.

### **FCC INFORMATION (U.S.A.)**

**1. IMPORTANT NOTICE: DO NOT MODIFY THIS UNIT!**

This product, when installed as indicated in the instructions contained in this manual, meets FCC requirements. Modifications not expressly approved by Yamaha may void your authority, granted by the FCC, to use the product.

**2. IMPORTANT:** When connecting this product to accessories and/or another product use only high quality shielded cables. Cable/s supplied with this product MUST be used. Follow all installation instructions. Failure to follow instructions could void your FCC authorization to use this product in the USA.

**3. NOTE:** This product has been tested and found to comply with the requirements listed in FCC Regulations, Part 15 for Class "B" digital devices. Compliance with these requirements provides a reasonable level of assurance that your use of this product in a residential environment will not result in harmful interference with other electronic devices. This equipment generates/uses radio frequencies and, if not installed and used according to the instructions found in the users manual, may cause interference harmful to the operation of other electronic devices. Compliance with FCC regulations does not guarantee that interference will not occur in all installations. If this product is found to be the source of interference, which can be determined by turning the product "OFF" and "ON", please try to eliminate the problem by using one of the following measures:

Relocate either this product or the device that is being affected by the interference.

Utilize power outlets that are on different branch (circuit breaker or fuse) circuits or install AC line filter/s.

In the case of radio or TV interference, relocate/reorient the antenna. If the antenna lead-in is 300 ohm ribbon lead, change the lead-in to coaxial type cable.

If these corrective measures do not produce satisfactory results, please contact the local retailer authorized to distribute this type of product. If you can not locate the appropriate retailer, please contact Yamaha Electronics Corporation, USA, 6660 Orangethorpe Avenue, Buena Park, CA 90620 U.S.A.

# LASER INFORMATION

**Laser Product Class:** Class 1

**Laser Diode Properties**

**Wavelength:** 779 – 789 nm

**Pulse Durations and Max. Output**

**at the Objective Lens of the Laser Pickup Unit**

**DC Erase Mode:** 20 mW Max. (Continuous),

**Write Mode:** Max.62 mW

(Max. Cycle 111 ns, Min. Cycle 30 ns at Max. Speed)

**Laserprodukt-Klasse:** Klasse 1

**Eigenschaften der Laserdiode**

**Wellenlänge:** 779 – 789 nm

**Impulsdauer und max. Ausgang an der**

**Objektivlinse der Laser-Abtasteinheit**

**Löschmodus (Gleichstrom):** max. 20 mW (kontinuierlich),

**Schreibmodus:** max. 62 mW

(max. Zyklus 111 ns, min. Zyklus 30 ns bei maximaler Geschwindigkeit)

**Classe du produit laser:** Classe 1

**Caractéristiques de la diode laser**

**Longueur d'onde:** 779 – 789 nm

**Durée des impulsions et sortie maximum depuis la lentille de focalisation du bloc capteur optique**

**Mode de suppression DC:** max. 20 mW (en continu),

**Mode de gravure:** max. 62 mW

(Cycle max. 111 ns, cycle min. 30 ns à vitesse maximale)

**Clase de producto láser:** Clase 1

**Propiedades del diodo láser**

**Longitud de onda:** 779 – 789 nm

**Duración del pulso y potencia de salida máxima en el objetivo de la unidad captora de láser**

**Modo de borrado DC:** 20 mW máx. (continua),

**Modo de escritura:** máx. 62 mW

(ciclo máx. 111 ns, ciclo min. 30 ns a velocidad máxima)

CLASS 1 LASER PRODUCT  
LASER KLASSE 1 PRODUKT  
LUOKAN 1 LASERLAITE  
KLASS 1 LASER APPARAT  
PRODUIT LASER DE CLASSE 1

DANGER - VISIBLE AND / OR INVISIBLE LASER RADIATION WHEN OPEN. AVOID DIRECT EXPOSURE TO BEAM.

COMPLIES WITH 21 CFR CHAPTER 1, SUBCHAPTER J.

## CAUTION

Use of controls or adjustments or performance of procedures other than those specified herein may result in hazardous radiation exposure.

## ACHTUNG

Halten Sie sich beim Bedienen und Einstellen der Bedienungselemente sowie bei der Bedienungsabfolge an die Anleitung, da sonst gefährliche Strahlen austreten können.

## ATTENTION

L'emploi de commandes, de réglages ou un choix de procédures différents des spécifications de cette brochure peut entraîner une exposition à d'éventuelles radiations pouvant être dangereuses.

## PRECAUCION

El usar los controles o ajustar o realizar procedimientos diferentes a los especificados aquí resultará en peligrosas exposiciones a la radiación.

VARO! AVATTAESSA JA SUOJALUKITUS OHITETTAESSA OLET ALTTINA NÄKYMÄTÖMÄLLE LASERSÄTEILYLLÄ. ÄLÄ KATSO SÄTEESEEN.

VARNING! OSYNLIG LASERSTRÅLNING NÄR DENNA DEL ÄR ÖPPNAD OCH SPÄRREN ÄR URKOPPLAD. BETRakta EJ STRÅLEN. STRÅLEN ÄR FARLIG.

CAUTION - VISIBLE AND / OR INVISIBLE LASER RADIATION WHEN OPEN. AVOID EXPOSURE TO BEAM.  
VARNING - SYNLIG OCH / ELLER OSYNLIG LASERSTRÅLNING NÄR DENNA DEL ÄR ÖPPNAD. STRÅLEN ÄR FARLIG.  
VARO ! AVATTAESSA OLET ALTTINA NÄKYVÄLLE JA / TAI NÄKYMÄTÖMÄLLE LASERSÄTEILYLLÄ. ÄLÄ KATSO SÄTEESEEN.  
VARNING - SYNLIG OCH / ELLER OSYNLIG LASERSTRÅLNING NÄR DENNA DEL ÄR ÖPPNAD. BETRakta EJ STRÅLEN.  
VORSICHT ! SICHTBARE LIND / ODER UNSICHTBARE LASERSTRÄHLUNG WENN ABDECKUNG GEÖFFNET. NICHT DEM STRAHL AUSSETZEN.  
ATTENTION - RADIATION VISIBLE ET / OU INVISIBLE LORSQUE L'APPAREIL EST OUVERT EVITEZ TOUTE EXPOSITION AU FAISCEAU.

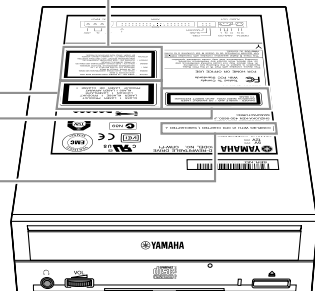



# OWNER'S MANUAL

English

INTERNAL  
E-IDE/ATAPI  
International

## CD-R/RW Drive **CRW-F1**

Advanced  
**AudiOMASTER**  
QUALITY RECORDING

**DiscT@2**<sup>TM</sup>

**SafeBurn**<sup>TM</sup>

COMPACT  
**disc**  
ReWritable



CREATING 'KANDO' TOGETHER

'KANDO' --- Inspiring the Heart and Spirit.

# SAFETY PRECAUTIONS

## **PLEASE READ THE FOLLOWING WARNINGS AND CAUTIONS CAREFULLY TO PREVENT PERSONAL INJURY AND DAMAGE TO THE DEVICE.**

These precautions explain how to use the device properly and safely, thereby preventing injury to yourself and others. This section has been sub-divided into a WARNING section and a CAUTION section, according to the likelihood and nature of any potential injuries or damage inflicted. They relate to your personal safety, and also help you prevent the risk of damage to the device. Please read these sections carefully prior to proceeding.



## **WARNING**

---

**Always follow these basic precautions to avoid short-circuit, damage, fire, or other hazards, and to avoid serious injury or fatal accident from electrical shock.**

- Do not attempt to open or disassemble the device to avoid the risk of electrical shock, fire, or malfunction.
- Do not look directly at the laser source to avoid the risk of eye damage or blindness.
- Do not insert fingers or foreign objects into the device to avoid the risk of electrical shock, fire, malfunction, or personal injury.
- Do not expose the device to high humidity or place liquid containers such as a flower vase on the device to avoid the risk of electrical shock, fire, or malfunction.
- Do not expose the device to temperature outside the range of 5 to 40 °C (41 to 104 °F) to avoid the risk of fire, deformation of the device panel, or malfunction.
- Do not expose the device to dusty place to avoid the risk of fire or malfunction.
- Always follow the owner's manual to set up or connect the devices properly to avoid the risk of electrical shock, fire, malfunction, or personal injury.
- If unusual smells, sounds or smoke come from the device, or if foreign objects such as liquid intrude into the device, turn off and unplug the computer immediately to avoid the risk of electrical shock, fire, or malfunction. Contact the store of purchase or your nearest Yamaha dealer (listed at the back of this manual).
- Be sure that the computer is electrically grounded to avoid the risk of electrical shock.
- Prior to cleaning the drive, always unplug the computer or do not handle the plug with wet hands to avoid the risk of electrical shock.



## CAUTION

**Always follow these basic precautions to avoid physical injury to yourself or others, and damage to the device or other property.**

- Always unplug the computer if it will not be used for a prolonged period or if there is possibility of lightning, to avoid the risk of electrical shock, fire, or short-circuit.
- Do not use the device near other electrical appliances such as televisions, radios, or speakers to avoid the risk of interferences between each other.
- Do not place the computer unstably to avoid the risk of malfunction or personal injury by its falling down.
- Do not place the device with a possibility of excessive vibration to avoid the risk of damage to written data or malfunction.
- Place the device horizontally to avoid the risk of damage to written data.
- Prior to transporting the device, remove the disc from the disc tray to avoid the risk of damage to written data.
- Use soft, dry cloths to wipe the device. Do not use benzene, paint thinner, detergents, or chemically treated wiped cloths, and do not place vinyl, plastic, or rubber objects on the device to avoid the risk of malfunction or damage to surface of the device.
- Do not rest your weight on or place heavy objects on the device, and do not apply excessive force to the buttons, switches, or connectors to avoid the risk of damage to the device or personal injury.
- Do not listen to audio with headphones at high volume for prolonged period to avoid auditory disorder.
- Prior to turning on the computer, always minimize the volume to avoid auditory disorder by a sudden burst of sound at high volume.
- Do not place the device near magnets or anything magnetized such as a display to avoid the risk of interferences between each other.
- Have the device serviced regularly to avoid internal dust buildup that can cause malfunction, damage or fire. For service information and service charges, contact the store of purchase or your nearest Yamaha dealer (listed at the back of this manual).
- This drive is for use only with movable equipment, weighing less than 18 kg.

## WARRANTY

YAMAHA AND ITS SUPPLIERS ACCEPT NO LIABILITY FOR ANY PROBLEMS THAT OCCUR AS A RESULT OF ANY OPERATIONS CARRIED OUT OTHER THAN THOSE STATED IN THE MANUAL FOR THIS PRODUCT, OR THE LOSS OR THE DAMAGE OF ANY DATA CAUSED AS A RESULT OF USING THIS PRODUCT.

## Precautions for Transportation

Transporting the device unfixed may damage its internal mechanism or circuits.

- Remove the disc from the disc tray of the device.
- Put the device in the original box.

For the Yamaha retail kit, refer to the original box to check that the complete accessories are included prior to installation. Accessories vary depending on the model.

To reduce power consumption of the CRW-F1 drive, set your computer to power saving mode. (P. 38)

- ©2002 YAMAHA CORPORATION. All Rights Reserved.
- This document may not, in whole or in part, be copied, photocopied, reproduced, translated, transmitted, or reduced to any electronic medium of machine readable form without prior consent in writing from Yamaha.
- Windows is a registered trademark of Microsoft Corporation.
- DiscT@2™ and SafeBurn™ are trademarks of Yamaha Corporation.
- All other trademarks are the property of their respective companies.  
™ and ® marks are not specified in this manual.



# Table of Contents

---

Features of the CRW-F1 Drive .....	1
Names and Functions of Parts .....	2
Front Panel.....	2
Rear Panel.....	3
Precautions on Use.....	4
Handling Discs .....	4
Copyright .....	4
Disclaimer of Indemnity.....	4
Compatible Discs.....	5
System Requirements .....	8
Preparing the CRW-F1 Drive .....	9
Serial Number.....	9
1 Decide the Installation Method.....	10
2 Set the Jumper Switch .....	15
3 Install the CRW-F1 Drive.....	17
4 Check Recognition of the CRW-F1 Drive .....	23
5 Install CD Writing Software.....	26
Loading/Ejecting a Disc .....	27
Troubleshooting.....	29
Firmware.....	36
CRW-F1 Drive Specifications .....	37
Technical Notes.....	40
Buffer Underrun Protection Function.....	40
Writing Methods.....	40

For details about installing and using the CD writing software, refer to the instruction for it.

- The information contained in this manual is subject to change without prior notice.
- Reproduction of this manual, either in part or in full, is expressly forbidden.

# Features of the CRW-F1 Drive

---

## Advanced Audio Master Quality Recording (High quality audio writing mode)

Audio Master Quality Recording enables you to create high quality audio CDs that can be played back beautifully on any compatible device including car stereos. In addition, the data quality of your CDs can be preserved for a long time. (P. 41) This mode is available for CD-R discs with a capacity of 650MB, 700MB, and 870MB.

## DiscT@2

The DiscT@2 function enables you to burn texts/pictures on the data surface of a CD-R disc. Writing software that supports the function is required to operate it. For details about this feature, refer to the instruction for the writing software.

### Note

- The function cannot be used with a CD-RW disc.
- Appearance of burned images such as pictures varies depending on the material of a disc.

## High speed writing/reading

The CRW-F1 drive supports up to 44X-speed writing for CD-R discs, up to 24X-speed writing/rewriting for CD-RW discs, and up to 44X-speed data reading or digital audio data extraction. The Full CAV method enables 44X-speed writing and high fidelity stable writing at once for CD-R discs.

### Tip

The Partial CAV method (P. 42) and the Full CAV method permit 24X-speed writing/rewriting for CD-RW discs.

## SafeBurn™ (Enhanced stability writing technology)

The generous 8MB buffer memory provides sufficient data storage to enable stable disc writing at high speeds. Even if data transfer from the computer is interrupted, the Buffer Underrun Protection function is activated to save CD-R discs from a writing error. (P. 40)

“Optimum Write Speed Control” adjusts the writing speed to the optimum rate for CD-R discs automatically. The maximum writing speed can be set with CD writing software.

### Note

- “Optimum Write Speed Control” can be activated when the maximum writing speed is set at 16X or more.
- The minimum writing speed to be automatically selected is 8X. Manually set the optimum writing speed if a writing speed supported by a disc is less than 8X.

## CD-MRW (CD Mount Rainier ReWriting)

CD-MRW is a new standard of packet writing. Compared to the ordinary packet writing, CD-MRW provides many useful functions such as background formatting. (P. 42)

# Names and Functions of Parts

## Front Panel

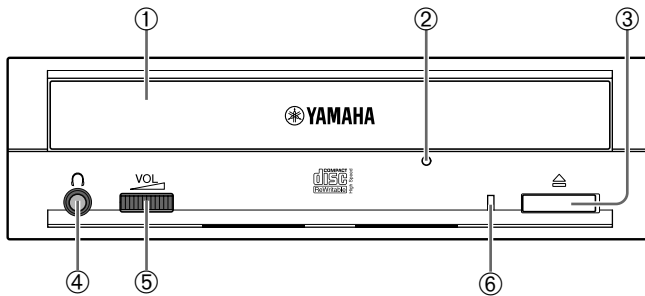

### ① Disc tray

Holds the disc. It is opened or closed by pressing the eject button. (P. 27)

### ② Manual eject hole

Forcibly opens the disc tray when the tray cannot be opened by pressing the eject button. (P. 28)

### ③ Eject button

Press to open or close the disc tray. (P. 27)

### ④ Headphone jack

Connects headphones or external speakers to the drive; has stereo mini-jack specifications.

### ⑤ Headphone volume dial

Controls the volume of the headphones. The volume increases as the dial is turned to the right.

### ⑥ LED

Indicates the operational status of the CRW-F1 drive by its colors and blinking patterns.

#### Lights or blinks blue

- Lights: Standby (with disc)
- Blinks: Opening/Closing disc tray, reading disc information (TOC), or playback audio
- Blinks rapidly: Reading data

#### Blinks purple

- Blinks: Accessing for writing or test writing
- Blinks rapidly: Writing

#### Blinks amber

Firmware update is incomplete. Retry to update the firmware.

#### Off

Standby (no disc), the disc tray is open, or power saving (operated via computer setting)

### Rear Panel

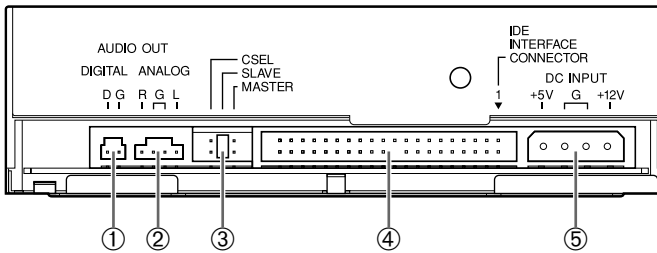

#### ① DIGITAL AUDIO OUT

Connects to the sound card in the computer using a digital audio cable if the sound card has an S/PDIF (digital audio) input jack. (P. 21)

#### ② ANALOG AUDIO OUT

Connects to the sound card in the computer using an audio cable. (P. 20)

#### ③ Jumper switch

Insert a plastic shunt into the switch to set the connection of the IDE to master or slave. The switch is set at slave by default. (P. 15)

#### ④ IDE INTERFACE CONNECTOR

Connects a 40-pin IDE cable. (P. 18)

#### ⑤ DC INPUT

Connects the 4-pin internal power cable of the computer. (P. 22)

# Precautions on Use

---

## Handling Discs

Take the following precautions to avoid trouble, such as writing errors, loss of recorded data, and malfunction of the drive, when handling discs.

- Do not place discs in a hot or damp place or where they will be exposed to direct sunlight.
- Do not touch the disc surface. Hold the disc by the edge when handling it.
- Remove dust and dirt from the disc surface. Use an air spray to remove dust. The disc surface may be scratched if strongly wiped with a dry cloth.
- Do not stick labels to the disc surface or write anything on it except where designated.
- Do not clean discs with chemicals or detergents.
- Do not bend or drop discs.

## Copyright

It is prohibited by law to duplicate copyright material for non-personal use without the prior consent of the copyright holder. When copying material with your CD-R/RW drive, take due care not to infringe the copyright.

## Disclaimer of Indemnity

- Yamaha assumes no liability for the loss of any profits incurred as a result of the loss or corruption of data written on a CD-R or CD-RW, for any loss or damage caused by or arising out of extraordinary circumstances (including circumstances that Yamaha has foreseen or could foresee), nor for any damages incurred or claimed by a third party.
- After handling important data, make a comparison between the original and the copied data (to confirm that the data has been copied properly).
- In no event shall Yamaha be liable for any damage to discs due to a buffer underrun error (P. 40) or for any other reason, or the inability to use distributed discs with your drive.
- Yamaha assumes no liability for the inability to write/playback discs because of their format.

### Compatible Discs

For the latest information about compatible discs, refer to the following website.

YAMAHA CD-R/RW Drive website

URL: <http://www.yamaha.co.jp/english/product/computer/>

#### Disc shape

Circular disc 12 cm, 8 cm

Card-type disc Discs confirmed by Yamaha

#### Note

Do not use any irregular shaped discs such as heart-shaped or star-shaped discs to avoid the risk of malfunction.

#### Recordable disc type

The CRW-F1 drive is compatible with the following discs.

---



##### CD-R discs

- Orange Book Part2 Vol.1 Version3.1-compliant discs
- Orange Book Part2 Vol.2 Version1.1-compliant discs



##### Writing speed

The writing speed settings are available in writing software.

1X, 4X, 8X, 16X, 44X

#### Note

- 44X-speed writing is enabled with the Full CAV method.
- Some writing speed settings may not be available depending on the specification of a disc.
- When the writing speed is set at 16X or 44X, "Optimum Write Speed Control" automatically adjusts the writing speed to the optimum rate for each disc within the selected writing speed.

##### Device compatibility

CD-R discs can be read/played back on a CD-ROM drive or a CD player.

---



## CD-RW discs

- Orange Book Part3 Vol.1 Version1.0-compliant discs
- Orange Book Part3 Vol.1 Version2.0-compliant discs

### Writing/Rewriting speed

The writing speed settings are available in writing software.  
2X, 4X

#### Note

- Some discs support only 2X speed.
- Some writing/rewriting speed settings may not be available depending on the specification of a disc.

### Device compatibility

CD-RW discs can be read/played back on a device that supports CD-RW discs (e.g. CD-ROM drive).



## High Speed CD-RW discs

Orange Book Part3 Vol.2-compliant discs

### Writing/Rewriting speed

The writing speed settings are available in writing software.  
4X, 10X, 12X

#### Note

- Some writing/rewriting speed settings may not be available depending on the specification of a disc.
- When using the packet writing method (P. 41) for writing/rewriting onto a High Speed CD-RW disc, you can select the 10X Full CAV method. For more details, refer to the instruction for the CD writing software. (CD writing software that has the feature to select the Full CAV method is required.)
- The Full CAV method is recommended when editing a written file with application software.

### Device compatibility

High Speed CD-RW discs can be read/played back on a CD-RW device that bears the High Speed CD-RW logo or a device that supports CD-RW discs (e.g. CD-ROM drive).

#### Note

In order to write, delete, read or play back a High Speed CD-RW disc, use a CD-R/RW drive that bears the High Speed CD-RW logo. When using a CD-ROM drive to read/play back a High Speed CD-RW disc, a drive supporting CD-RW discs is required. A CD-R/RW drive without the logo may not recognize a High Speed CD-RW disc, resulting in computer malfunction.

Refer to the Yamaha website to check the disc compatibility prior to using a YAMAHA CD-R/RW drive without the logo for a High Speed CD-RW disc.

URL: <http://www.yamaha.co.jp/english/product/computer/>

### **Ultra Speed CD-RW discs**

Orange Book Part3 Vol.3-compliant discs

### **Writing/Rewriting speed**

The writing speed settings are available in writing software.

10X, 16X, 24X

#### **Note**

- 24X-speed writing/rewriting is enabled with the Partial CAV method.
- Some writing/rewriting speed settings may not be available depending on the specification of a disc.
- When using the packet writing method (P. 41) for writing/rewriting onto an Ultra Speed CD-RW disc, you can select the 24X Full CAV method. For more details, refer to the instruction for the CD writing software. (CD writing software that has the feature to select the Full CAV method is required.)
- The Full CAV method is recommended when editing a written file with application software.

### **Device compatibility**

Ultra Speed CD-RW discs can be read/played back on a device that supports CD-RW discs (e.g. CD-ROM drive) or a device that bears the High/Ultra Speed CD-RW logo.

---



## System Requirements

The CRW-F1 drive is designed to operate in the following computer environment. If your computer does not meet these requirements, the CRW-F1 drive may not write at the maximum speed.

### Computer (PC/AT compatible)

- CPU: Pentium II-class or higher, 300 MHz or faster
- RAM: 32MB (64MB or more is recommended)  
64MB or more is required (128MB is recommended) for Windows 2000 Professional, while 128MB or more is required (256MB is recommended) for Windows XP.
- An empty 5 ¼-inch drive bay (for installing the CRW-F1 drive as an additional drive into the computer)
- Hard drive space  
Writing data on a CD-R/RW disc requires 50MB to 100MB of free space as a working area on the hard drive. When writing data on a CD-R/RW disc after creating an image file, there must be enough free space on the hard drive to store the image file in addition to the working area (a total of up to 1.1GB). However, hard drive space for image files is not required when directly writing onto a CD-R/RW disc from a hard drive or CD-ROM using the CRW-F1 drive (on-the-fly writing).

### Image file

An image file is data files that are collected to be written on a CD-R/RW disc. The file is useful for writing the same data onto multiple discs. For details, refer to the instruction for the CD writing software.

### Operating system

Windows 95 (OSR2 or later), Windows 98, Windows 98 Second Edition, Windows Me, Windows 2000 Professional, Windows XP (Home Edition/Professional Edition)

### CD writing software

The CRW-F1 drive requires CD writing software to write onto a CD-R/RW disc. Use the CD writing software that supports the CRW-F1 drive. For details about installing and using the CD writing software, refer to the instruction for it.

# Preparing the CRW-F1 Drive

## Preparing tools

- **Phillips screwdriver:** Use the proper screwdriver for the screws to install the CRW-F1 drive into the computer.
- **Narrow pliers:** Insert and remove the included plastic shunt for the jumper switch.

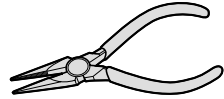
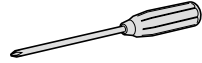

## Serial Number

The serial number, printed on the label on the top of your CRW-F1 drive, is required when you have a question about the drive or need user support services.

Please write the serial number down in the space below prior to installing the CRW-F1 drive into your computer. It will be difficult to check the serial number after installation.

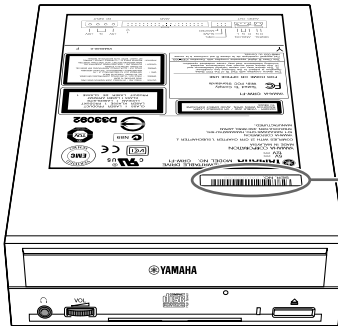

Serial number  
(10 characters: 3 letters +  
7 numbers)

Serial Number									
---------------	--	--	--	--	--	--	--	--	--

---

The following describes how to install the CRW-F1 drive on the computer by taking a tower-type computer for example.

**Note**

The methods of removing the computer cover or panels and installing an internal device vary depending on the computer model. Refer to the instruction for the computer.

## 1 Decide the Installation Method

Check the connection of any IDE device installed to decide the installation method of the CRW-F1 drive.

**Note**

- The CRW-F1 drive supports Ultra ATA/33. (The CRW-F1 drive is operated with Ultra ATA/33 even if the motherboard or the IDE cable support Ultra ATA/66 or Ultra ATA/100.)
- The 40-pin IDE cable (with 40 wires) included in a Yamaha retail kit supports Ultra ATA/33. IDE devices connected to the 40-pin IDE cable are operated with Ultra ATA/33 even if the devices support Ultra ATA/66 or Ultra ATA/100.
- Install the CRW-F1 drive horizontally.

---

### 1 Turn off and unplug the computer.

When handling internal computer devices, always turn off the computer to avoid the risk of an electrical shock or damage to the drive or computer devices. Be sure to unplug the computer prior to handling any internal computer device.

---

### 2 Remove all peripheral devices and cables connected to the computer prior to removing the computer cover.

Clothes and body can become charged with static electricity. Discharge any static electricity by touching a metallic part of the case or power unit. For more information, refer to the instruction for the computer.

---

### Installing the CRW-F1 drive as an additional drive

Check the IDE channel (primary/secondary and master/slave) connecting the CRW-F1 drive. (P. 12 – 14)

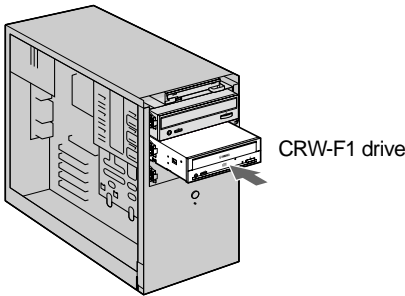

#### Note

An empty 5 ¼-inch drive bay is required to install the CRW-F1 drive.

### Replacing an existing IDE device with the CRW-F1 drive

Connect the CRW-F1 drive to the cable that was previously connected to the IDE device.

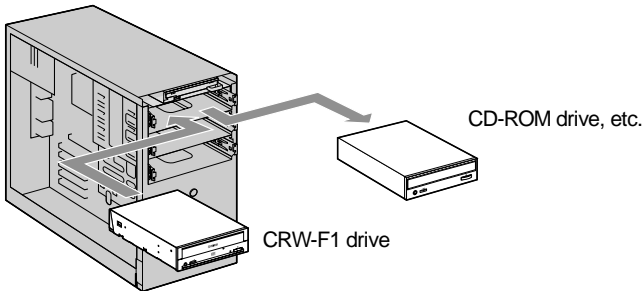

#### Note

When replacing a SCSI device such as a SCSI type CD-ROM drive, do not connect the CRW-F1 drive to the cable that was previously connected to the SCSI device. Use a 40-pin IDE cable to connect the CRW-F1 drive to the computer.

## Examples of connecting the CRW-F1 drive

The following describes how to connect the CRW-F1 drive for example.

### Example 1: As a secondary slave (For additional drive)

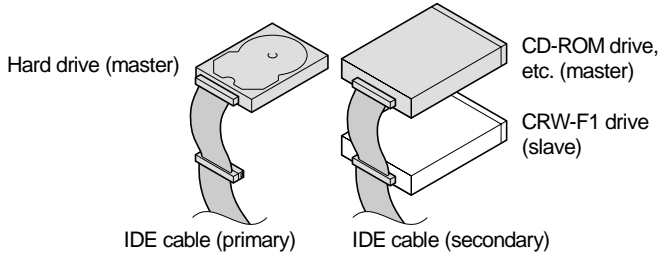

### Example 2: As a secondary master

(For replacing the existing drive with the CRW-F1 drive)

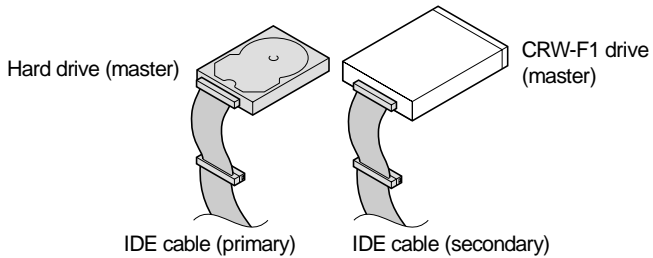

**For the best performance of the CRW-F1 drive, connecting the drive as the sole secondary master is recommended.**

Continued on next page

### Note

- The CRW-F1 drive is set at slave by default. Set the device to master and connect the device to the end of the cable when connecting an IDE device to an IDE cable solely.
- Connecting the CRW-F1 drive as the primary master is recommended if no IDE device is connected to the primary IDE cable such as the case that the operating system is started up from a SCSI hard drive.
- Some IDE cables have only one connector to connect the device. Prepare an IDE cable with two connectors to connect the devices if another connector is required.
- Check the master/slave setting prior to connecting the removed device to another connector. For more details, refer to the instruction for the device or refer to the manufacturer's website.

### Enhanced-IDE (E-IDE)

E-IDE is a standard for connecting computers to IDE devices such as hard drives, CD-ROM drives and CD-R/W drives. Most computers have two IDE connectors (primary and secondary). Each connector can be connected to two devices with an IDE cable. Two IDE devices connected by one IDE cable are called “master” and “slave.”

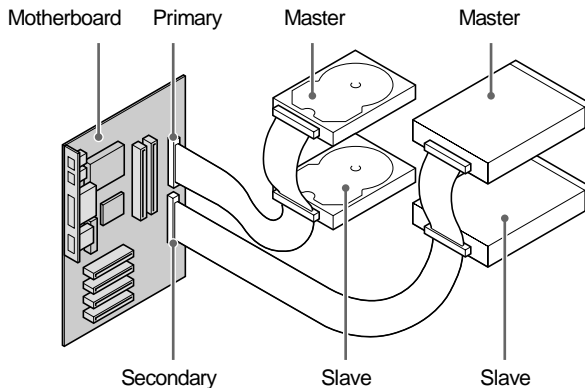

---

The master/slave settings for general IDE devices are as follows.

- **Hard drive:** Change the setting with the jumper switch on the circuit board on the rear panel or the hard drive bottom panel. The cable select (CSEL) setting is required for some hard drives.
- **CD-ROM drive, etc.:** Change the setting with the jumper switch on the rear panel.

**Note**

Assign each IDE device to master or slave respectively when two IDE devices are connected to one IDE cable. Connect the IDE device to the end of the IDE cable when the device is set to master, or connect it to the middle of the cable when it is set to slave.

## 2 Set the Jumper Switch

Refer to the examples of connecting the CRW-F1 drive on page 12, and set the CRW-F1 drive to master/slave to support your computer environment.

**Set the plastic shunt at the jumper switch on the rear panel with narrow pliers.**

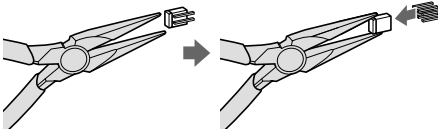

The position to be inserted the plastic shunt varies depending on the setting.

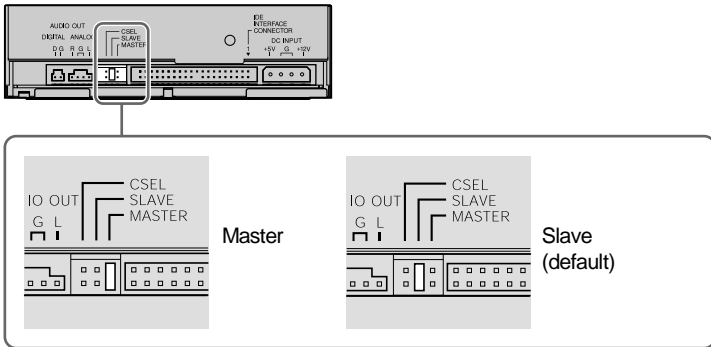

**The CRW-F1 drive is set at slave by default.**

**When replacing an IDE device (master) with the CRW-F1 drive, set the drive to master.**



---

**Note**

- The function of a plastic shunt is to electrically connect the jumper switch contacts. Inserting and removing the pin turn the settings on and off.
- Be sure to turn off the computer prior to setting the jumper switch.

** Cable Select (CSEL)**

For the computer supporting a cable select function, insert a plastic shunt into the CSEL jumper switch so that the computer will automatically adjust the CRW-F1 drive setting to master or slave.

If the CSEL setting results in any problems to the CRW-F1 drive, set the drive to master or slave.

Refer to the instruction for the computer to find out if it supports the CSEL function.

### 3 Install the CRW-F1 Drive

The following describes how to install the CRW-F1 drive as an additional drive for example.

#### 1 Prepare to install.

##### Installing the CRW-F1 drive as an additional drive

Remove the front cover from the 5 ¼-inch drive bay.

##### Replacing

Remove all cables connected to the CD-ROM or other devices to be replaced. Then remove the device itself from the computer.

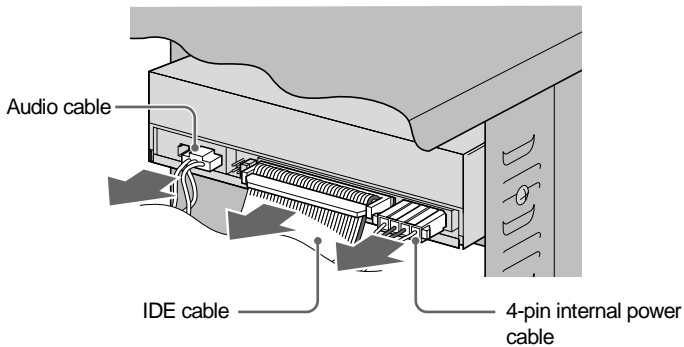

##### Note

- Be careful not to damage the various cables connected to the rear panel of the CD-ROM drive.
- The audio cable is usually caught by the hook at the top of the connector. Release the hook and remove the connector without using excessive force.
- Do not apply excessive force to the CD-ROM drive or cables.
- Hold the cable by the connector to remove the cable. Pulling the cable itself with excessive force may damage the wires inside.

---

## 2 Install the CRW-F1 drive carefully into the drive bay and temporarily fasten the screws by hand.

Be sure that there is enough space to connect the 4-pin internal power cable, 40-pin IDE cable, and audio cable prior to temporarily fastening the included four screws to the fixed position.

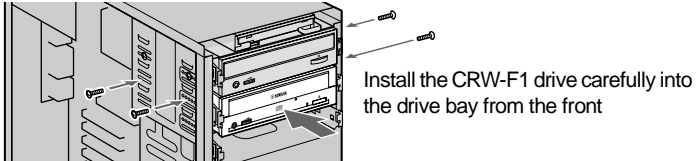

### Note

Do not apply excessive force to the CRW-F1 drive.

---

## 3 Connect a 40-pin IDE cable.

Connect a 40-pin IDE cable to the IDE connector on the motherboard and the IDE interface connector on the rear panel of the CRW-F1 drive. Be sure that the colored wire is connected to the first pin of the connectors, as shown in the diagram below.

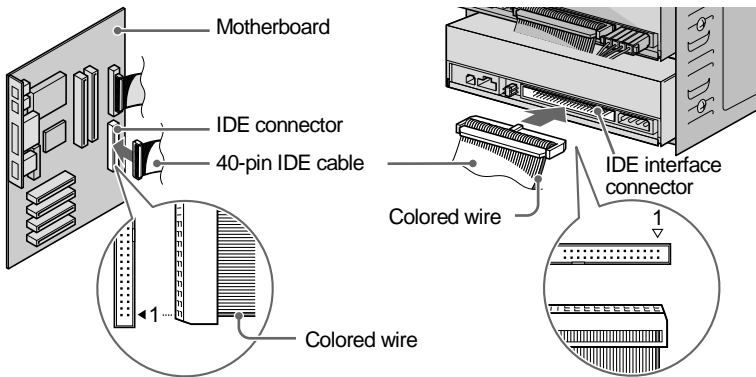

Continued on next page

### Note

- The 40-pin IDE cable (with 40 wires) included in a Yamaha retail kit supports Ultra ATA/33. IDE devices connected to the 40-pin IDE cable are operated with Ultra ATA/33 even if the devices support Ultra ATA/66 or Ultra ATA/100.
- The CRW-F1 drive is operated with Ultra ATA/33 even if the drive can be connected by an IDE cable (with 80 wires) supporting Ultra ATA/66 or Ultra ATA/100.
- Use an IDE cable no longer than 45.7 cm (18 inches).
- When two IDE devices are connected to one IDE cable, be sure to assign each as master/slave respectively.

---

## 4 Connect an audio cable if necessary.

The sound card of the computer enables you to listen to audio CDs played back on the CRW-F1 drive. There are two methods to connect the CRW-F1 drive and the sound card: analog connection and digital connection.

### Audio CD playback

- Audio is available from the headphones or speakers connected to the headphone jack on the front panel of the CRW-F1 drive (this is convenient for the computer without a sound card). In such a case, connecting an audio cable is not required.
- An audio cable is not required to extract an image file from an audio CD since data is transferred via the IDE cable.
- If the CRW-F1 drive is installed as an additional drive and a CD-ROM drive or a DVD-ROM drive is already connected to the sound card, using the existing drive to play back an audio CD is recommended.

## Analog connection

Connect one end of the audio cable (the end with one connector) to the analog audio output jack on the rear panel of the CRW-F1 drive. Be sure that the connector is in the correct direction prior to connecting it.

There are two types of connectors at the other end of the audio cable. Select the one that fits the sound card: Vertical connector (PH) and Horizontal connector (MPC). Use only one of the two connectors, and leave the other free. Check the direction of the connector prior to connecting it to the sound card.

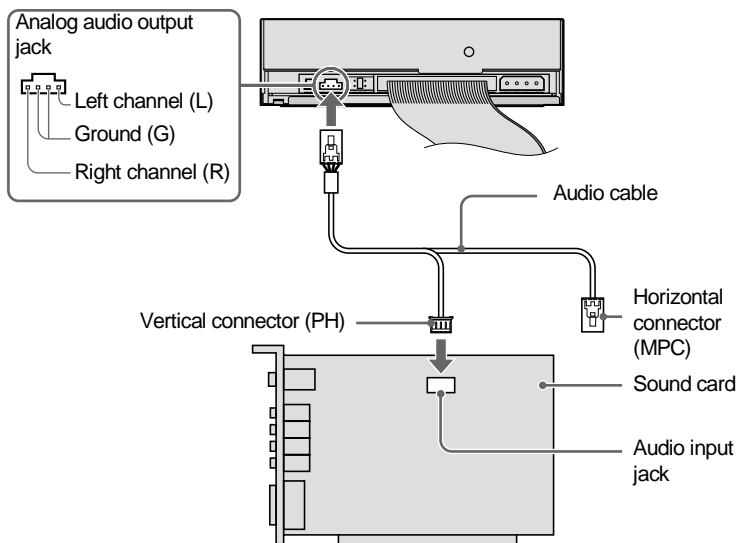

### Note

Some sound cards have more than one audio input jack, including those which do not support the specification of the CRW-F1 drive. If playback audio cannot be heard from the speakers, refer to the instruction for the sound card.

Continued on next page

### Digital connection

Digital connection enables you to enjoy higher quality audio with less distortion since the digital signals recorded on the audio CD are output to the sound card with high fidelity.

Connect the digital audio output jack of the CRW-F1 drive and the S/PDIF (digital audio) input jack of the sound card with a digital audio cable. Be sure that the connector is in the correct direction prior to connecting it.

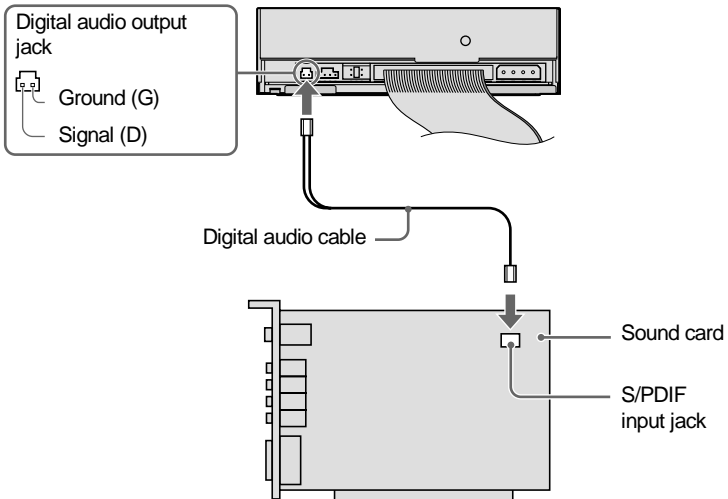

### Note

A digital audio cable with a proper connector and a sound card with an S/PDIF (digital audio) input jack are required.

---

- 
- 5** Connect the 4-pin internal power cable of the computer (DC 5 V and DC 12 V) to the power connector on the rear panel of the CRW-F1 drive.

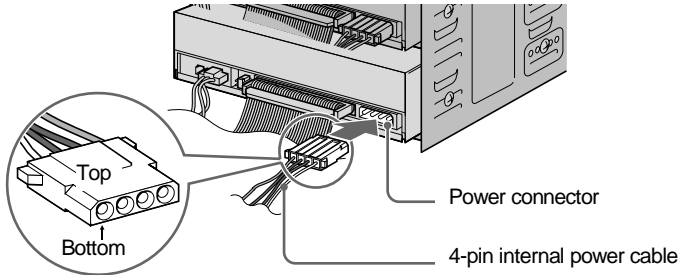

**Note**

The 4-pin internal power cable cannot be connected if it is upside down. If the connector does not connect easily, check that it is in the correct direction.

- 
- 6** Tighten four screws fastened tentatively with a Phillips screwdriver.

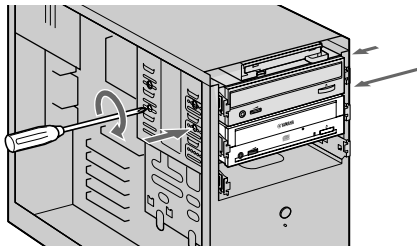

- 
- 7** Attach the computer cover and reconnect the peripheral devices and cables.
-

## 4 Check Recognition of the CRW-F1 Drive

### 1 Plug in and turn on the computer.



LED blinks blue, then turns off.

Check that the LED blinks blue, and then turns off.

### 2 Check that the CRW-F1 drive is properly recognized by Windows.

The operation varies depending on your operating system.

#### For Windows XP

- 1 Select **Start** on the taskbar, then **Control Panel**, **System**, **Hardware** tab, and **Device Manager**. The **Device Manager** dialog box appears.

#### Note

If the **System** icon is not shown in the **Control Panel** window, click **Switch to Classic View** on the left side of the window.

- 2 If there is **+** to the left of **DVD/CD-ROM drives**, click **+**.  
“YAMAHA CRW-F1E” should be shown when the CRW-F1 drive has been recognized properly.

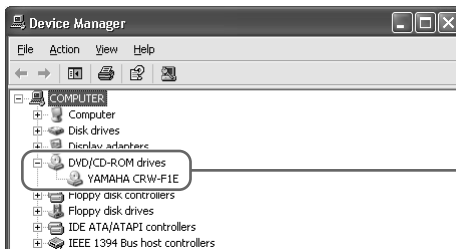

“YAMAHA CRW-F1E” is shown.





---

**If the drive name is not shown or there is  or  mark.**

The CRW-F1 drive has not been recognized properly. Check the cable connections and the master/slave settings of the IDE devices connected to the computer.

**For Windows 2000 Professional**



- 1 Select **Start** on the taskbar, then **Settings, Control Panel, System, Hardware** tab, and **Device Manager**. The **Device Manager** dialog box appears.
- 2 If there is  to the left of **DVD/CD-ROM Drive**, click . “YAMAHA CRW-F1E” should be shown when the CRW-F1 drive has been recognized properly.

**For Windows 95/98/98 Second Edition/Me**

- 1 Select **Start** on the taskbar, then **Settings, Control Panel, System, and Device Manager** tab. The **Device Manager** dialog box appears.

**Note**

For Windows Me, if the **System** icon is not shown in the **Control Panel** window, click **view all Control Panel options** on the left side of the window.

- 2 If there is  to the left of **CDROM**, click . “YAMAHA CRW-F1E” should be shown when the CRW-F1 drive has been recognized properly.

---

### 3 **Change the DMA setting.**

The DMA setting may not be displayed, depending on your computer. In such a case, use the CRW-F1 drive without changing the DMA setting.

 **Tip**

To maximize the performance of the CRW-F1 drive, changing the DMA setting for other IDE devices such as a hard drive or a CD/DVD-ROM drive is recommended.

Continued on next page

### For Windows XP/2000 Professional

- 1 Log on to the administrator account.
- 2 In the **Device Manager** dialog box (P. 23), select the IDE channel (primary/secondary) connected to the CRW-F1 drive and then **Advanced Settings** tab.
- 3 Set “Transfer Mode” to “DMA if available” in the “Device 0” item (for master) or the “Device 1” item (for slave).

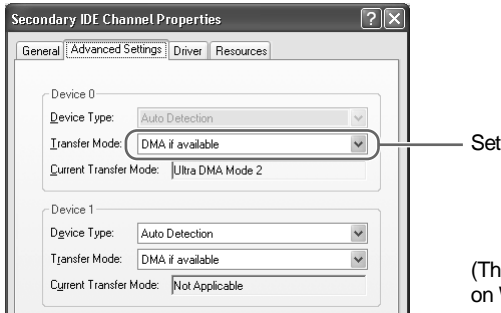

### Note

The CRW-F1 drive operation may become unstable, depending on your computer environment. In such a case, set “Transfer Mode” to “PIO only.”

### For Windows 95/98/98 Second Edition/Me

- 1 In the **Device Manager** dialog box (P. 24), select **YAMAHA CRW-F1E Properties** and then **Settings** tab.
- 2 Check “DMA.”

### Note

The CRW-F1 drive operation may become unstable, depending on your computer environment. In such a case, uncheck “DMA.” The “Simultaneous Data Transfer” setting does not affect CRW-F1 drive operation.

---

### Recommended DMA settings (transfer mode settings)

Operating System	Recommended	Remarks
Windows XP/ 2000 Professional	DMA mode	PIO mode if operation becomes unstable
Windows 95/98/ 98 Second Edition/Me	Check	Uncheck if operation becomes unstable

#### Direct Memory Access (DMA)

DMA is a method that transfers data between various peripheral devices (e.g., a hard drive, CD-R/RW drive, etc.) and the computer memory without going through the CPU in the computer. DMA transfer setting increases the data transfer speed and the processing speed by reducing strain on the CPU.

---

## 5 Install CD Writing Software

Install the CD writing software. For details about installing the CD writing software, refer to the instruction for it.

# Loading/Ejecting a Disc

---

Prior to the operation, check that the computer is turned on.

---

## 1 Open the disc tray by pressing the eject button.



Press the eject button

---

## 2 Place the disc onto the disc tray properly with its label facing upward.

Or remove the disc from the disc tray carefully so not to damage it.

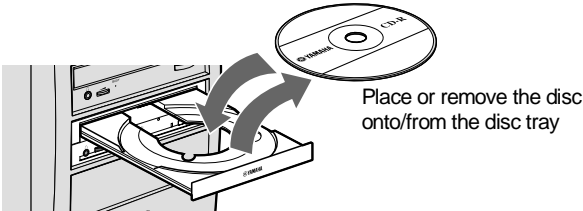

Place or remove the disc onto/from the disc tray

---

## 3 Close the disc tray by pressing the eject button or by gently pushing the disc tray into the computer.

---

### Note

- Place or remove the disc after the disc tray has fully opened. Do not push or pull the disc tray with applying excessive force to avoid damage to the drive or the disc.
- The disc tray does not open while the application software prohibits ejecting, including when the drive accesses the disc.

---

## Manually Ejecting a Disc

If the disc tray fails to open for some reason, such as a power failure, follow the steps below to remove the disc from the drive.

### Note

Frequent use of this operation may cause malfunction of the drive.

---

- 1 Prepare a thin pin-like object, such as a straightened paper clip.**

Use an object less than 2 mm in diameter and more than 3 cm in length.

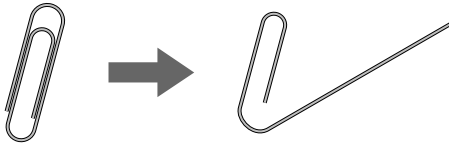

- 
- 2 Turn off the computer.**
- 

- 3 Insert the thin pin-like object straight into the manual eject hole, and push it in.**

When the disc tray opens, remove the disc.

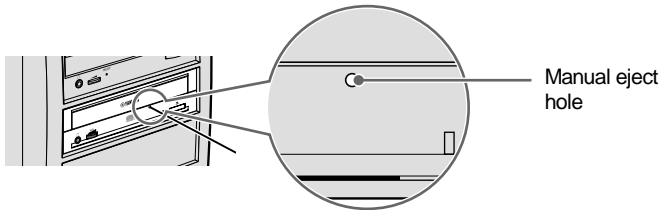

- 
- 4 Turn on the computer, and close the disc tray.**
-

# Troubleshooting

Refer to the YAMAHA CD-R/RW Drive website for the latest support information, including the troubleshooting guide.

**YAMAHA CD-R/RW Drive website**

**URL:** <http://www.yamaha.co.jp/english/product/computer/>

**Europe**

**URL:** <http://www.yamaha-it.de/>

## 1 The CRW-F1 drive is not recognized by the operating system. (P. 23)

### ● Is the 4-pin internal power cable connected properly to the CRW-F1 drive?

Turn off the computer, and remove the computer cover. Check that the connector of the 4-pin internal power cable is connected to the CRW-F1 drive in the correct direction, and that the 4-pin internal power cable is fully connected. (P. 10, 22)

### ● If the CRW-F1 drive is connected to another 4-pin internal power cable that properly conducts power to another device, is the CRW-F1 drive turned on?

Turn off the computer. Be sure that the CRW-F1 drive is connected to another 4-pin internal power cable that properly conducts power to another device, and check that the CRW-F1 drive is turned on when turning on the computer. (P. 10, 22)

If the drive is turned on, the computer's power unit may be damaged.

If the drive is not turned on, contact the store of purchase or your nearest Yamaha dealer (listed at the back of this manual).

### ● Is the IDE cable connected properly to the CRW-F1 drive?

Turn off the computer and remove the computer cover. Check that the connector of the IDE cable connected to the CRW-F1 drive is in the correct direction, and that the IDE cable is fully connected. (P. 10, 18)

Then check that the pins of the IDE interface connector of the CRW-F1 drive are not bent.

### ● Is the IDE cable connected properly to the motherboard?

Check that the connector of the IDE cable is connected to the motherboard in the correct direction, and that the IDE cable is fully connected. (P. 18)

- **Is each IDE device set respectively?**

When one IDE device is connected to one IDE cable, be sure that the device is set to master or CSEL.

When two IDE devices are connected to one IDE cable, be sure that both devices are not set to master (or slave).

When the CRW-F1 drive is set to CSEL, reset it to master or slave. (P. 15)

When you have the problem even if each IDE device is set properly as above, contact the store of purchase or your nearest Yamaha dealer (listed at the back of this manual).

## 2 The disc tray does not open when you press the eject button.

- **Is the CRW-F1 drive recognized by the operating system? (P. 23)**

Refer to “The CRW-F1 drive is not recognized by the operating system.”  
(Troubleshooting, Item 1)

- **Is any CD writing software being used?**

Some CD writing software prohibits ejecting while accessing. (If you are using such a software program, the disc tray does not open even if the eject button is pressed.)

In such a case, follow the steps in the software window to eject the disc, or quit the CD writing software prior to pressing the eject button.

- **Is the disc tray opened when the computer is restarted?**

Quit all running application software, restart your computer, and press the eject button of the CRW-F1 drive.

- **Is the disc tray opened if the IDE cable is removed from the CRW-F1 drive?**

Turn off the computer and remove the IDE cable from the IDE interface terminal on the rear panel of the CRW-F1 drive. (P. 10, 18)

Restart the computer, and press the eject button of the CRW-F1 drive once again.

- **Turn off the computer, and remove the disc following “Manually Ejecting a Disc.” (P. 28)**

If the disc tray is caught in the drive and does not come out, or if it cannot be opened or closed using the eject button after it is pulled out manually, contact the store of purchase or your nearest Yamaha dealer (listed at the back of this manual).

### 3 The disc is ejected without order (or it comes out spontaneously).

- **Is the disc set properly (horizontally) on the disc tray?**  
Set the disc properly, and close the disc tray.
- **Is the disc dusty or dirty?**  
Remove dust or dirt from the disc using an air spray or a dry soft cloth. To avoid damaging discs, wipe the disc gently from the center to the edge of the disc.
- **Does the drive accept other discs (audio CD, CD-ROM, blank CD-R disc, etc.)?**  
If a specific disc is ejected, the disc itself may be damaged or deformed.  
If all discs are ejected, contact the store of purchase or your nearest Yamaha dealer (listed at the back of this manual).

### 4 No data can be read from a disc.

- **Is the disc ejected without order?**  
Refer to “The disc is ejected without order (or it comes out spontaneously).” (Troubleshooting, Item 3)
- **Is the disc compatible with the drive? (P. 5, 37)**  
Be sure that the disc is compatible with the CRW-F1 drive.
- **Is the disc dusty or dirty?**  
Remove dust or dirt from the disc using an air spray or a dry soft cloth. To avoid damaging discs, wipe the disc gently from the center to the edge of the disc.
- **Can data be read from other discs (audio CD, CD-ROM, etc.)?**  
If no data can be read from a specific disc, data may be written in a format that the drive cannot recognize, or the disc itself may be damaged or deformed. Note that no data can be read from blank discs, and the CRW-F1 drive infrequently fail to read data correctly from a disc even if the disc is compatible with the drive.



- **Does the LED of the CRW-F1 drive light correctly when a disc is inserted?**

When a disc is inserted, the LED will blink blue for a moment and then light blue. (P. 2)

If no data can be read from a specific disc, data may be written in a format that the drive cannot recognize, or the disc may be damaged or deformed.

If the LED does not light (stating that the drive cannot recognize the disc) no matter what type of disc is inserted, contact the store of purchase or your nearest Yamaha dealer (listed at the back of this manual).

## 5 The playback of an audio CD (CD-DA) is inaudible.

- **Check that the volume is not set to the minimum level.**
- **If the playback audio from headphones or external speakers connected to the computer is inaudible, be sure that the audio cable is properly connected to the CRW-F1 drive and the sound card. If the sound card has more than one audio input jack, connect the audio cable to the other input jack. (P. 20, 21)**
- **For Windows XP/Me, follow the steps if the playback audio from headphones connected to the CRW-F1 drive is inaudible.**

If Windows Media Player 7.0 or later is used with Windows XP/Me, this problem can happen since the digital playback option is activated by default setting.

### For Windows XP

1 In the **Device Manager** dialog box (P. 23), select **YAMAHA CRW-F1E Properties** and then **Properties** tab.

2 Uncheck “Enable digital CD audio for this CD-ROM device” in the “Digital CD Playback” item.

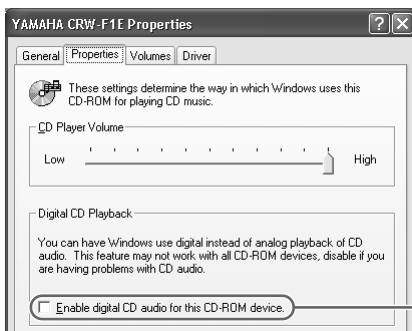

Uncheck  
(This screen is an example  
on Windows XP.)

Continued on next page

- 3 Start “Windows Media Player.” In the menu bar, select **Tools, Options, Devices** tab, **CD-RW Drive**, and **Properties**.
- 4 Select “Analog” in the “Playback” item.

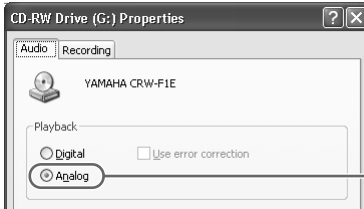

Select  
(This screen is an  
example on Windows  
Media Player 8.0.)

### For Windows Me

- 1 Follow step 1 and 2 on page 32, and uncheck “Enable digital CD audio for this CD-ROM device.”
- 2 Start “Windows Media Player.” In the menu bar, select **Tools, Options** and **CD Audio** tab.
- 3 Uncheck “Digital playback” in the “Playback Settings” item.

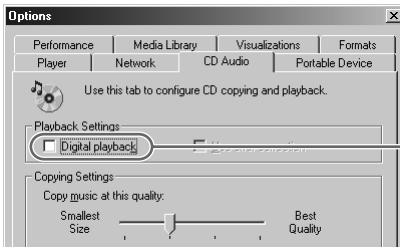

Uncheck  
(This screen is an  
example on Windows  
Media Player 7.0.)

---

## 6 No data can be read from any CDs, a disc is ejected spontaneously, or the LED does not light when a disc is inserted. (The LED does not change to blinking blue and then lighting blue.) (P. 2)

Remove the IDE cable from the CRW-F1 drive while the 4-pin internal power cable is connected to the drive, and insert the disc once again. If a specific disc is automatically ejected or cannot be read, the disc itself may have a problem. If the drive does not accept any compatible discs (and the LED does not light), contact the store of purchase or your nearest Yamaha dealer (listed at the back of this manual).

## 7 The error message “Buffer Underrun” is displayed.

If your CD writing software supports Buffer Underrun Protection, it is required to be activated. For more details, refer to the instruction for the CD writing software.

To prevent the occurrence of a buffer underrun and to increase the efficiency of data writing, try the following:

- Reduce the data writing speed.
- Create an image file on the hard drive.
- Optimize the hard drive. (Defragmentation)
- Do not start any application software including screen savers during data writing.
- Deactivate the power management for the hard drive.
- Set the data transfer mode of any IDE device such as a hard drive or CD-ROM drive to “DMA.” (P. 24)
- Deactivate Windows Active Desktop.
- Quit all memory-resident software programs.
- Check your CD writing software settings with the instruction for it.

### Note

A writing error may happen if the drive is vibrated while data is being written on a CD-R or a CD-RW disc.

## 8 Other problems

### ● Is more than one CD writing software installed on your computer?

Installing more than one CD writing software on a computer may cause instability of operation.

Continued on next page 

## 🔧 For Windows XP

Windows XP includes the CD writing function as a standard feature. Disable the function when the other software that supports the CRW-F1 drive is used.

- 1 Select **My Computer**, YAMAHA CRW-F1 drive icon (Right-click), and **Properties**.

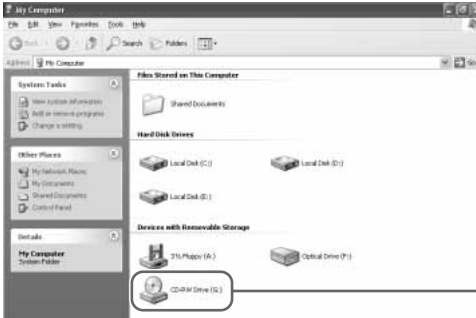

Select YAMAHA  
CRW-F1 icon

### Note

Generally, “CD-RW Drive” is displayed at the side of the icon. The display may vary depending on the computer environment.

- 2 In the **CD-RW Drive Properties** dialog box, select the **Recording** tab, and uncheck “Enable CD recording on this drive.”

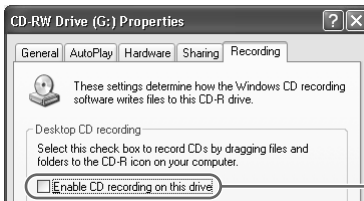

Uncheck

- **CD writing software must support the CRW-F1 drive in order to recognize the drive.**

Contact the manufacturer of your CD writing software to see whether the software supports the CRW-F1 drive.

- **Is the power capacity of your computer sufficient?**

The computer may not operate due to insufficient power capacity.

Check the specifications of your computer and its current environment. The power consumption of the CRW-F1 drive is 15 W during writing/reading.

# Firmware

Firmware refers to the operating software designed for your CD-R/RW drive. It is stored in the drive's flash memory so that it can be rewritten.

For the operation reliability, the latest firmware is available on the internet. For more information about the latest firmware, refer to the following websites.

YAMAHA CD-R/RW Drive website

URL: <http://www.yamaha.co.jp/english/product/computer/>

Europe

URL: <http://www.yamaha-it.de/>

The latest user support information including firmware information is available on the websites.

Refer to the website regularly to check the latest information.

## Checking the firmware version in your CRW-F1E drive

### For Windows XP/2000 Professional

Use your CD writing software to check the firmware version.

### For Windows 95/98/98 Second Edition/Me

In the **Device Manager** dialog box (P. 24), select **YAMAHA CRW-F1E** to display the **YAMAHA CRW-F1E Properties** dialog box, and then select the **Settings** tab.

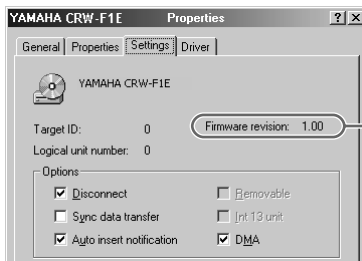

The revision number varies depending on the default firmware version. (This screen is an example on Windows Me.)

# CRW-F1 Drive Specifications

## Supported Formats

	Write	Read	Play back <sup>*4</sup>
CD-DA	●	●	●
CD TEXT	●	●	●
CD-ROM <sup>*1</sup>	●	●	●
Mixed Mode CD-ROM (CD-ROM+CD-DA)	●	●	●
CD-ROM XA <sup>*1</sup>	●	●	●
Photo CD <sup>*1</sup>	● <sup>*2 *3</sup>	●	●
Video CD	●	●	●
CD-i	●	● <sup>*3</sup>	—
CD EXTRA <sup>*1</sup>	●	●	●
CD-MRW	●	●	●

<sup>\*1</sup> includes multisession

<sup>\*2</sup> proper disc required

<sup>\*3</sup> proper application software required

<sup>\*4</sup> proper application software may be required depending on the format

## Writing Methods

Disc-at-Once (DAO)  
 Session-at-Once (SAO)  
 Track-at-Once (TAO)  
 Packet Writing  
 Audio Master Quality Recording  
 (High quality audio writing mode)  
 CD-MRW (CD Mount Rainier ReWriting)

## Writing/Reading Speed

Writing	CD-R	1X, 4X, 8X, 16X CLV 44X (max.) Full CAV
	CD-RW	2X, 4X, 10X, 12X, 16X CLV 24X Partial CAV 10X, 24X Full CAV (Packet writing)
Reading	DATA	44X (max.) Full CAV
	CD-DA	44X (max.) Full CAV (Audio data extraction) 1X CLV (Audio playback)
	Video CD	10X (max.) Full CAV
	Note) Session unclosed disc:	12X (max.) CLV

## Data Capacity

700MB (79 minutes)  
 650MB (74 minutes)

## Maximum Recording Time in Audio Master Quality Recording

68 minutes (with a 700MB disc)  
 63 minutes (with a 650MB disc)

<b>Data Transfer Rate (Mode 1)</b>	150KB/s (1X) to 6,600KB/s (44X)
<b>Interface</b>	Enhanced IDE (E-IDE) /ATAPI
<b>Burst Transfer Rate</b>	Program I/O (PIO) mode 4: 16.7MB/s Multi-word DMA mode 2: 16.7MB/s Ultra DMA mode 2: 33.3MB/s (Ultra ATA/33)
<b>Data Buffer Size</b>	8MB (3,176 sectors)
<b>Average Access Time</b>	130 ms (random access)
<b>Sector Size</b>	2,048 to 2,448 bytes
<b>Installing Style</b>	Horizontal
<b>Disc Loading Type</b>	Front automatic tray loading
<b>Audio Out</b>	Analog (Line Out specifications) <ul style="list-style-type: none"> <li>• Frequency range: 20 to 20,000 Hz</li> <li>• Output level: 700 mVrms</li> </ul> Digital <ul style="list-style-type: none"> <li>• S/PDIF format</li> <li>• Output level: TTL</li> </ul>
<b>Power Consumption</b>	15 W (writing/playback) 4 W (standby) 1 W (power saving, operated via computer setting)
<b>Power Supply</b>	DC 5 V $\pm$ 5% DC 12 V $\pm$ 10%
<b>Operating Environment</b>	Temperature: 5 to 40 °C Humidity: 25 to 80% RH (no condensation)
<b>Dimensions</b>	Width: 148.0 mm Height: 42.6 mm Depth: 198.1 mm
<b>Weight</b>	0.9 kg

## Safety/EMC Compliance

The CRW-F1 drive conforms to the following specifications.

Country/ Region	Compliance Specifications			Remarks
	Category	Item	Standard	
<b>USA</b>	Safety	Electricity	UL60950	Information Technology Equipment
		Laser	21CFR1040.10 FDA Chapter 1, Subchapter J	Class I Laser Product
	EMC	Emission	47CFR15 FCC Part 15, Subpart B	Peripheral Device
<b>Canada</b>	Safety	Electricity	CSA C22.2 No. 60950	Information Technology Equipment
	EMC	Emission	ICES-003	Class B Digital Device
<b>EU</b>	Safety	Electricity	EN60950	Information Technology Equipment
		Laser	EN60825	Class I Laser Product
	EMC	Emission	EN55022	Class B Information Technology Equipment
		Immunity	EN55024	
<b>Australia New Zealand</b>	EMC	Emission	AS/NZ 3548	Class B Information Technology Equipment
<b>Taiwan</b>	EMC	Emission	CNS13438	Class B Information Technology Equipment
<b>Japan</b>	EMC	Emission	VCCI	Class B Information Technology Equipment

Note that the specifications of the CRW-F1 drive are subject to change without notice due to improvements.



# Technical Notes

---

## Buffer Underrun Protection Function

CD-R/RW drives are equipped with a buffer memory, which temporarily stores data that is being transferred. When the buffer memory becomes empty due to a delay of data transfer for any reason, a writing error happens. Such condition is defined as buffer underrun, and such an error is defined as a buffer underrun error.

### **Buffer Underrun Protection is featured in the CRW-F1 drive.**

When buffer underrun almost happens, Buffer Underrun Protection temporarily suspends the writing process. Writing resumes when enough data has accumulated in the buffer memory. Buffer Underrun Protection in the CRW-F1 drive is extremely accurate, resulting in seamless recording before and after suspension.

### Test writing

Test writing is a function to check for the possible occurrence of buffer underrun in your computer environment. When Buffer Underrun Protection of the CD writing software is activated, the test writing function cannot be operated. Buffer Underrun Protection should be deactivated to operate the test writing function.

## Writing Methods

### **Disc-at-Once (DAO)**

This method is used to write all data onto a disc in one operation. It writes multiple pieces of data without placing a space between data, starting with the innermost track of the disc. Once data is written by this method, no data can be added to the same disc even if there is free space available on the disc. This method is useful for making a backup copy of an entire disc.

### **Track-at-Once (TAO)**

This method is used to write data on a disc on a track-by-track basis. A track can be defined as the smallest unit of area that contains an ordinary program, image file, text file, etc. This method enables you to add data to the same disc, one track of data at a time, as long as there is free space available on the disc. A disc that contains data written in several sessions is defined as a multi-session disc.

An area that records data and management information (Lead-in/Lead-out) is defined as a session. Lead-in and Lead-out are signals written for stating the starting and ending points of one session.

#### **Note**

Ordinary audio CD players can only play back single-session discs or the first session on a multi-session disc. Do not record audio data on the second and subsequent sessions.

### Session-at-Once (SAO)

This method is used to write data on a disc on a session-by-session basis. Unlike Track-at-Once described above, Session-at-Once enables you to record multiple tracks onto a disc at a time. CD EXTRA, for example, uses this method to write multiple pieces of audio data (or multiple tracks) in the first session and information required for computers in the second session. This method enables you to add data into the same disc, one session at a time, as long as there is free space available on the disc. A disc that contains data written in several sessions by this method is defined as a multi-session disc, like a disc written by the Track-at-Once method.

### Packet Writing

This method is used to record data onto a disc on a file-by-file basis. This method divides a track into small segments called “packets” so that data can be written on a packet-by-packet basis, which means that you can write data in much the same way as you copy data to a floppy or hard drive. Since the data can be written easily, packet writing is proper to daily data backup. Packet writing also enables you to add packets to a disc as long as there is free space available on the disc.

#### Note

- Discs need to be formatted for packet writing prior to use.
- Formatting a CD-RW disc using packet writing software reduces its storage capacity by about 100MB since packet writing requires exclusive space for itself.
- For CD-R discs, deleting data means masking data but not actually removing data. Therefore, actual free space in a CD-R never be increased even if data is deleted.

### Audio Master Quality Recording (High quality audio writing mode)

This method enables you to record high quality data that can be played back with the 1.4 m/s linear velocity.

#### Note

- Audio Master Quality Recording is enabled with the 1X-, 4X-, or 8X-speed Disc-at-Once writing method.
- Maximum recording time is 63 minutes for a 650MB CD-R disc and 68 minutes for a 700MB CD-R disc.
- Audio CDs that are created with Audio Master Quality Recording may not be played back on certain audio recorders and CD-R/RW drives.

---

## **CD-MRW (CD Mount Rainier ReWriting)**

This method is a new standard of packet writing for a CD-RW disc and supports defect control by the drive, background formatting, and disc ejecting during formatting. It enables you to use a CD-RW disc like a floppy disk.

### **Note**

Formatting a CD-RW disc using CD-MRW reduces its storage capacity by about 150MB since CD-MRW requires exclusive disc space.

## **Constant Linear Velocity (CLV)**

The disc rotation speed is adjusted to keep the data transfer rate constant while writing/reading data.

## **Constant Angular Velocity (CAV)**

The data transfer rate is adjusted to keep the disc rotation speed constant while writing/reading data. The Full CAV method employs CAV all through data writing/reading.

## **Partial CAV**

The CAV method is employed for inner tracks of a disc and the CLV method for outer tracks while writing/reading data.



## **Distributors and Head Offices / Vertriebs- und Hauptgeschäftsstelle Distributeurs et sièges sociaux / Distribuidores y Casas matrices**

If you have any questions, please contact the store of purchase or your nearest Yamaha dealer listed below. Contact Yamaha Corporation Japan from outside of the listed countries.

Falls Sie weitere Fragen haben, wenden Sie sich an Ihren Fachhändler oder den örtlichen Yamaha-Händler (eine Liste der Yamaha-Händler befindet sich am Ende dieses Handbuchs). Aus anderen Ländern als den aufgeführten wenden Sie sich an Yamaha Corporation Japan.

Si vous avez des questions à poser, veuillez prendre contact avec le magasin où vous avez fait l'achat de l'appareil ou un revendeur de matériel Yamaha le plus proche de votre domicile parmi ceux énumérés ci-dessous. Prenez contact avec Yamaha Corporation Japan si vous ne vous trouvez pas dans un des pays mentionnés:

Si tiene alguna duda, póngase en contacto con el establecimiento de adquisición o con su representante Yamaha más cercano indicado a continuación. En caso de países no contemplados en la lista, póngase en contacto con Yamaha Corporation Japan:

### **EUROPE, EASTERN EUROPE and RUSSIA**

**Yamaha Elektronik Europa GmbH  
IT-Sales Division**

Siemensstrasse 22-34,  
D-25462 Rellingen, GERMANY  
**URL: <http://www.yamaha-it.de/>**

TEL: +80092624222

(AUSTRIA, BELGIUM, DENMARK, FINLAND,  
FRANCE, GERMANY, HUNGARY, ICELAND,  
IRELAND, ITALY, LUXEMBOURG,  
NETHERLANDS, NORWAY, PORTUGAL, SPAIN,  
SWEDEN, SWITZERLAND, UNITED KINGDOM)

TEL: +80093067  
(MONACO)

If you are calling from outside the countries mentioned above, or if you can't get through on the Yamaha toll-free number, use the following number instead:

TEL: +3214400793

### **U.S.A.**

**Yamaha Electronics Corporation, USA**

6660 Orangethorpe Avenue,  
Buena Park, CA 90620, U.S.A.

TEL: +1 714 522 9105

FAX: +1 714 670 0108

**URL: <http://www.yamaha.com/>**

### **CANADA**

**Yamaha Canada Music Ltd.**

135 Milner Avenue, Scarborough,  
Ontario M1S 3R1, CANADA

TEL: +1 416 298 5664

FAX: +1 416 292 0732

**URL: <http://www.yamaha.ca/>**

### **AUSTRALIA**

**Yamaha Music Australia Pty., Ltd.**

Level 1, 99 Queensbridge Street  
Southbank, Victoria 3006

AUSTRALIA

TEL: +61 3 9693 5111

FAX: +61 3 9699 2332

### **SINGAPORE, MALAYSIA, KOREA, THAILAND, PHILIPPINES, INDIA, VIETNAM, CAMBODIA, MYANMAR, INDONESIA and IRAN**

**Yamaha Electronics Asia Pte Ltd.**

138 Cecil Street

#05-02/03 Cecil Court, Singapore 069538 SINGAPORE

TEL: +65 223 3992

FAX: +65 223 9810

### **TAIWAN**

**Yamaha KHS Music Co., Ltd.**

11F, No.150, Tun Hua North Rd.

Taipei, TAIWAN R.O.C.

TEL: +886 2 2713 8999

FAX: +886 2 2713 8666

**URL: <http://www.yamahakhs.com/>**

### **JAPAN**

**Yamaha Corporation**

**AV & IT Business Group**

**Overseas Sales & Marketing Division**

10-1 Nakazawa-cho, Hamamatsu-shi, Shizuoka-ken  
430-8650, JAPAN

TEL: +81 53 460 3411

FAX: +81 53 467 2110

**URL: <http://www.yamaha.co.jp/english/>**



'KANDO' --- Inspiring the Heart and Spirit.

YAMAHA CORPORATION

X3143A0 CRW-F1(W)

Printed in Malaysia

Printed on 70% recycled paper