

YAMAHA RX-V490/390

Natural Sound Stereo Receiver

Thank you for selecting this YAMAHA stereo receiver.



OWNER'S MANUAL

CONTENTS

Safety Instructions	2
Features	4
Supplied Accessories	4
Profile of This Unit	5
Speaker Setup	6
Connections	7
Speaker Balance Adjustment ...	11
Basic Operations	14
Tuning Operations	17
Preset Tuning	18
Using Digital Sound Field Processor (DSP)	21
Setting the SLEEP Timer	26
Remote Control Transmitter ...	27
Notes About the Remote Control Transmitter	28
Troubleshooting	29
Specifications	30

IMPORTANT!

Please record the serial number of this unit in the space below.

Serial No.:

The serial number is located on the rear of the unit.
Retain this Owner's Manual in a safe place for future reference.

WARNING

TO REDUCE THE RISK OF FIRE OR ELECTRIC SHOCK, DO NOT EXPOSE THIS UNIT TO RAIN OR MOISTURE.

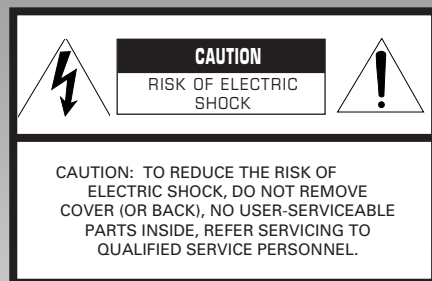

• Explanation of Graphical Symbols



The lightning flash with arrowhead symbol, within an equilateral triangle, is intended to alert you to the presence of uninsulated "dangerous voltage" within the product's enclosure that may be of sufficient magnitude to constitute a risk of electric shock to persons.



The exclamation point within an equilateral triangle is intended to alert you to the presence of important operating and maintenance (servicing) instructions in the literature accompanying the appliance.

SAFETY INSTRUCTIONS

- 1 Read Instructions – All the safety and operating instructions should be read before the unit is operated.
- 2 Retain Instructions – The safety and operating instructions should be retained for future reference.
- 3 Heed Warnings – All warnings on the unit and in the operating instructions should be adhered to.
- 4 Follow Instructions – All operating and other instructions should be followed.
- 5 Water and Moisture – The unit should not be used near water – for example, near a bathtub, washbowl, kitchen sink, laundry tub, in a wet basement, or near a swimming pool, etc.
- 6 Carts and Stands – The unit should be used only with a cart or stand that is recommended by the manufacturer.

6A A unit and cart combination should be moved with care. Quick stops, excessive force, and uneven surfaces may cause the unit and cart combination to overturn.



- 7 Wall or Ceiling Mounting – The unit should be mounted to a wall or ceiling only as recommended by the manufacturer.
- 8 Ventilation – The unit should be situated so that its location or position does not interfere with its proper ventilation. For example, the unit should not be situated on a bed, sofa, rug, or similar surface, that may block the ventilation openings; or placed in a built-in installation, such as a bookcase or cabinet that may impede the flow of air through the ventilation openings.
- 9 Heat – The unit should be situated away from heat sources such as radiators, stoves, or other appliances that produce heat.
- 10 Power Sources – The unit should be connected to a power supply only of the type described in the operating instructions or as marked on the unit.
- 11 Power-Cord Protection – Power-supply cords should be routed so that they are not likely to be walked on or pinched by items placed upon or against them, paying particular attention to cords at plugs, convenience receptacles, and the point where they exit from the unit.
- 12 Cleaning – The unit should be cleaned only as recommended by the manufacturer.
- 13 Nonuse Periods – The power cord of the unit should be unplugged from the outlet when left unused for a long period of time.
- 14 Object and Liquid Entry – Care should be taken so that objects do not fall into and liquids are not spilled into the inside of the unit.
- 15 Damage Requiring Service – The unit should be serviced by qualified service personnel when:

- A. The power-supply cord or the plug has been damaged; or
 - B. Objects have fallen, or liquid has been spilled into the unit; or
 - C. The unit has been exposed to rain; or
 - D. The unit does not appear to operate normally or exhibits a marked change in performance; or
 - E. The unit has been dropped, or the cabinet damaged.
- 16 Servicing – The user should not attempt to service the unit beyond those means described in the operating instructions. All other servicing should be referred to qualified service personnel.
 - 17 Power Lines – An outdoor antenna should be located away from power lines.
 - 18 Grounding or Polarization – Precautions should be taken so that the grounding or polarization is not defeated.
 - 19 Outdoor Antenna Grounding – If an outside antenna is connected to this unit, be sure the antenna system is grounded so as to provide some protection against voltage surges and built-up static charges. Article 810 of the National Electrical Code, ANSI/NFPA 70, provides information with regard to proper grounding of the mast and supporting structure, grounding of the lead-in wire to an antenna discharge unit, size of grounding conductors, location of antenna discharge unit, connection to grounding electrodes, and requirements for the grounding electrode.

EXAMPLE OF ANTENNA GROUNDING

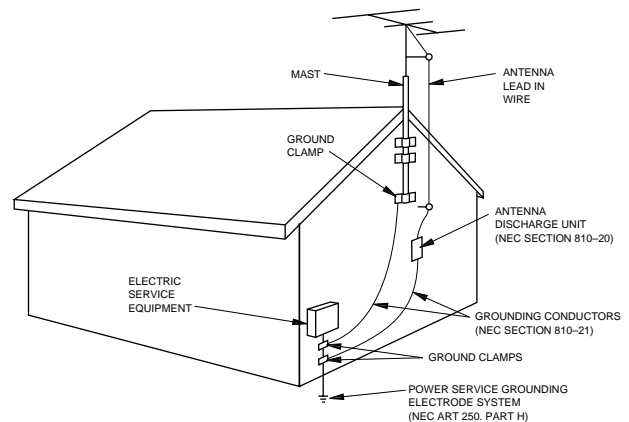

NEC – NATIONAL ELECTRICAL CODE

Note to CATV system installer:

This reminder is provided to call the CATV system installer's attention to Article 820-40 of the NEC that provides guidelines for proper grounding and, in particular, specifies that the cable ground shall be connected to the grounding system of the building, as close to the point of cable entry as practical.

Caution: Read this before operating your unit

- 1 To assure the finest performance, please read this manual carefully. Keep it in a safe place for future reference.
- 2 Install this unit in a cool, dry, clean place – away from windows, heat sources, sources of excessive vibration, dust, moisture and cold. Avoid sources of humming (transformers, motors). To prevent fire or electrical shock, do not expose the unit to rain or water.
- 3 Do not operate the unit upside-down. It may overheat, possibly causing damage.
- 4 Never open the cabinet. If something drops into the set, contact your dealer.
- 5 Do not use force on switches, controls or connection wires. When moving the unit, first disconnect the power plug and the wires connected to other equipment. Never pull the wires themselves.
- 6 Do not attempt to clean the unit with chemical solvents; this might damage the finish. Use a clean, dry cloth.
- 7 Always set the VOLUME control to “– ∞” before starting the audio source play. Increase the volume gradually to an appropriate level after the play back has been started.
- 8 To prevent lightning damage, pull out the power cord and remove the antenna cable during an electrical storm.
- 9 Be sure to read the “TROUBLESHOOTING” section regarding common operating errors before concluding that the unit is faulty.
- 10 AC outlet
Do not connect audio equipment to the AC outlet on the rear panel if that equipment requires more power than the outlet is rated to provide.

FCC INFORMATION

1. IMPORTANT NOTICE : DO NOT MODIFY THIS UNIT!

This product, when installed as indicated in the instructions contained in this manual, meets FCC requirements. Modifications not expressly approved by Yamaha may void your authority, granted by the FCC, to use the product.

2. IMPORTANT : When connecting this product to accessories and/or another product use only high quality shielded cables. Cable/s supplied with this product MUST be used. Follow all installation instructions. Failure to follow instructions could void your FCC authorization to use this product in the USA.

3. NOTE : This product has been tested and found to comply with the requirements listed in FCC Regulations, Part 15 for Class “B” digital devices. Compliance with these requirements provides a reasonable level of assurance that your use of this product in a residential environment will not result in harmful interference with other electronic devices.

This equipment generates/uses radio frequencies and, if not installed and used according to the instructions found in the users manual, may cause interference harmful to the operation of other electronic devices.

Compliance with FCC regulations does not guarantee that interference will not occur in all installations. If this product is found to be the source of interference, which can be determined by turning the unit “OFF” and “ON”, please try to eliminate the problem by using one of the following measures:

Relocate either this product or the device that is being affected by the interference.

Utilize power outlets that are on different branch (circuit breaker or fuse) circuits or install AC line filter/s.

In the case of radio or TV interference, relocate/reorient the antenna. If the antenna lead-in is 300 ohm ribbon lead, change the lead-in to coaxial type cable.

If these corrective measures do not produce satisfactory results, please contact the local retailer authorized to distribute this type of product. If you can not locate the appropriate retailer, please contact Yamaha Electronics Corp., U.S.A. 6660 Orangethorpe Ave, Buena Park, CA 90620.

The above statements apply ONLY to those products distributed by Yamaha Corporation of America or its subsidiaries.

We Want You Listening For A Lifetime

YAMAHA and the Electronic Industries Association's Consumer Electronics Group want you to get the most out of your equipment by playing it at a safe level. One that lets the sound come through loud and clear without annoying blaring or distortion – and, most importantly, without affecting your sensitive hearing. Since hearing damage from loud sounds is often undetectable until it is too late, YAMAHA and the Electronic Industries Association's Consumer Electronics Group recommend you to avoid prolonged exposure from excessive volume levels.



FEATURES

● 5 Speaker Configuration

RX-V490

Front: 70W + 70W (8Ω) RMS Output Power, 0.04% THD, 20–20,000 Hz

Center: 70W (8Ω) RMS Output Power, 0.1% THD, 1 kHz

Rear: 15W + 15W (8Ω) RMS Output Power, 0.7% THD, 1 kHz

RX-V390

Front: 60W + 60W (8Ω) RMS Output Power, 0.04% THD, 20–20,000 Hz

Center: 60W (8Ω) RMS Output Power, 0.2% THD, 1 kHz

Rear: 15W (8Ω) RMS Output Power, 0.7% THD, 1 kHz

● Digital Sound Field Processor

RX-V490

4 Programs for Digital Sound Field Processing

2 Programs for Dolby Surround Decoding (DOLBY PRO LOGIC and DOLBY PRO LOGIC ENHANCED)

RX-V390

2 Programs for Digital Sound Field Processing

2 Programs for Dolby Surround Decoding (DOLBY PRO LOGIC and DOLBY 3 STEREO)

● Automatic Input Balance Control for Dolby Surround

● Test Tone Generator for Easier Speaker Balance Adjustment

● 3 Center Channel Modes (NORMAL/WIDE/PHANTOM)

● 40-Station Random Access Preset Tuning

● Automatic Preset Tuning

● Preset Station Shifting Capability (Preset Editing)

● IF Count Direct PLL Synthesizer Tuning System

● Video Signal Input/Output Capability

● SLEEP Timer

● Remote Control Capability

SUPPLIED ACCESSORIES

After unpacking, check that the following parts are contained.

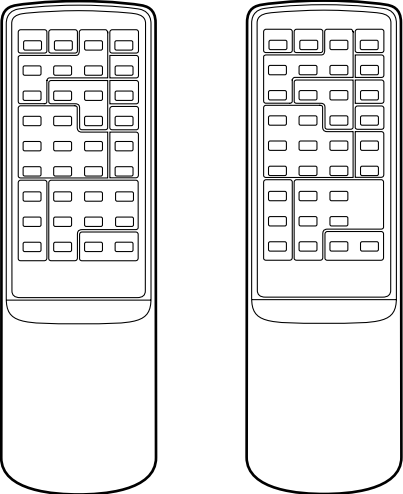
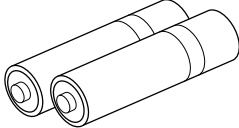
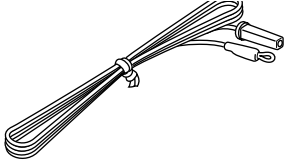
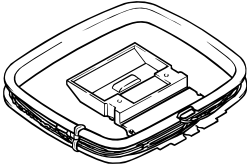
<p>Remote Control Transmitter</p> <p>RX-V490 RX-V390</p> 	<p>Batteries (size AA, R6, UM-3)</p> 	<p>Indoor FM Antenna</p> 
<p>AM Loop Antenna</p> 		

PROFILE OF THIS UNIT

You are the proud owner of a Yamaha stereo receiver – an extremely sophisticated audio component. The Digital Sound Field Processor (DSP) built into this unit takes advantage of Yamaha's undisputed leadership in the field of digital audio processing to bring you a whole new world of listening experiences. Follow the instructions in this manual carefully when setting up your system, and this unit will sonically transform your room into a totally new listening environment. In addition, you get incredible realism from Dolby-encoded video sources using the built-in Dolby Pro Logic Surround Decoder. Please read this operation manual carefully and store it in a safe place for later reference.

Digital Sound Field Processing

What is it that makes live music so good? Today's advanced sound reproduction technology lets you get extremely close to the sound of a live performance, but chances are you'll still notice something missing: the acoustic environment of the live concert hall. Extensive research into the exact nature of the sonic reflections that create the ambience of a large hall has made it possible for Yamaha engineers to bring you this same sound in your own listening room, so you'll feel all the sound of a live concert.

Furthermore, our technicians, armed with sophisticated measuring equipment, have even made it possible to capture the acoustics of actual music venues to allow you to accurately recreate live performance environments in your own home.

Dolby Pro Logic Surround

The Dolby Pro Logic Surround Decoder program lets you experience the dramatic realism and impact of a Dolby Surround movie theater sound in your own home. Dolby Pro Logic gets its name from its professional-grade steering logic circuitry, which provides greater effective front and rear channel separation for a much higher degree of realism than the "passive" Dolby Surround circuits found in less sophisticated home audio/video equipment. Dolby Pro Logic Surround provides a true center channel, so there are four independent channels, unlike passive Dolby Surround which has in effect only three channels: left, right, and rear. This center channel allows listeners seated in even less-than-ideal positions to hear the dialog originating from action on the screen while getting a stereo effect as well.

In addition, this unit features a built-in automatic input balance control. This circuit always presents you the best surround conditions without performing manual adjustments.

Dolby Pro Logic Surround + DSP **RX-V490 only**

You can also enjoy a combination of Dolby Pro Logic Surround and DSP in the sound field program "  PRO LOGIC ENHANCED".

It recreates the surround effect of a movie theater, effectively duplicating its multiple surround loudspeaker system, completely surrounding the listener with the sounds of the action taking place on the screen.

SPEAKER SETUP

SPEAKERS TO BE USED

This unit is designed to provide the best sound-field quality with a 5 speaker configuration. The most effective speakers to use with this unit are front speakers, rear speakers and a center speaker. You may omit the center speaker. (Refer to the “**4-Speaker Configuration**” shown below.)

The front speakers are used for the main source sound plus the effect sounds. They will probably be the speakers from your present stereo system. The rear speakers are used for the effect and surround sounds, and the center speaker is for the center sounds (dialog etc.) within the Dolby Surround encoded programs. The center speaker needs to be equal in power to the front speakers, although the rear speakers should not be equal. However, all the speakers should have high enough power handling to accept the maximum output of this unit.

SPEAKER CONFIGURATION

5-Speaker Configuration

This configuration is the most effective and recommended one. In this configuration, the center speaker is necessary as well as the rear speakers. If a Dolby Surround program is selected, conversations will be output from the center speaker and the ambience will be excellent.

- Set the center channel mode to the “**NORMAL**” or “**WIDE**” position. (For details, refer to page 12.)

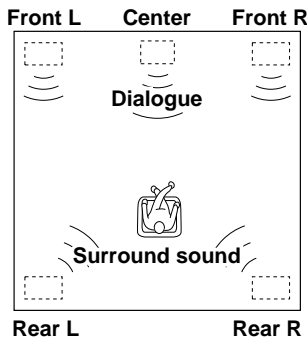

* **RX-V390 only**

As this unit is equipped with a monaural amplifier for the rear channel, you may use one rear speaker only instead of using two rear speakers.

However, the use of two rear speakers is recommended when there are more than one listener in the listening room.

When using one rear speaker, place it right behind your listening position.

4-Speaker Configuration

The center speaker is not used in this configuration. If a Dolby Surround program is selected, the center sound is output from the left and the right front speakers. However, the sound effect of other programs can be the same as that of the 5-speaker configuration.

- Be sure to set the center channel mode to the “**PHANTOM**” position. (For details, refer to page 12.)

• **RX-V390 only**

The program **DOLBY 3 STEREO** is useless in this configuration.

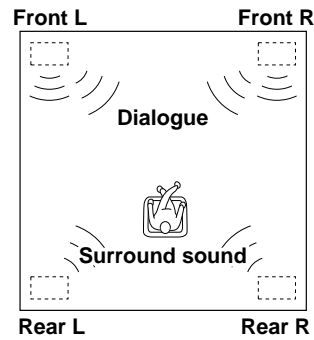

SPEAKER PLACEMENT

The recommended speaker configuration, the 5-speaker configuration, will require two speaker pairs: **front speakers** (your normal stereo speakers), and **rear speakers**, plus a **center speaker**. When you place these speakers, refer to the following.

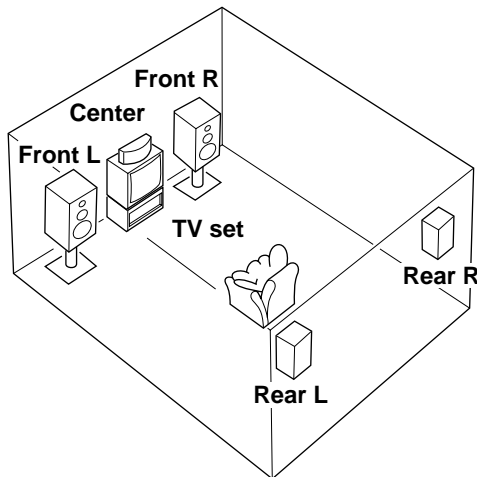

Front: In normal position. (The position of your present stereo speaker system.)

Rear: Behind your listening position, facing slightly inward. Nearly six feet (approx. 1.8 m) up from the floor.

Center: Precisely between the front speakers. (To avoid interference with TV sets, use a magnetically shielded speaker.)

CONNECTIONS

- Before attempting to make any connections to or from this unit, be sure to first switch OFF the power to this unit and to any other components to which connections are being made.
- When making connections between this unit and other components, be sure all connections are made correctly, that is to say L (left) to L, R (right) to R, “+” to “+” and “-” to “-”. Also, refer to the owner’s manual for each component to be connected to this unit.

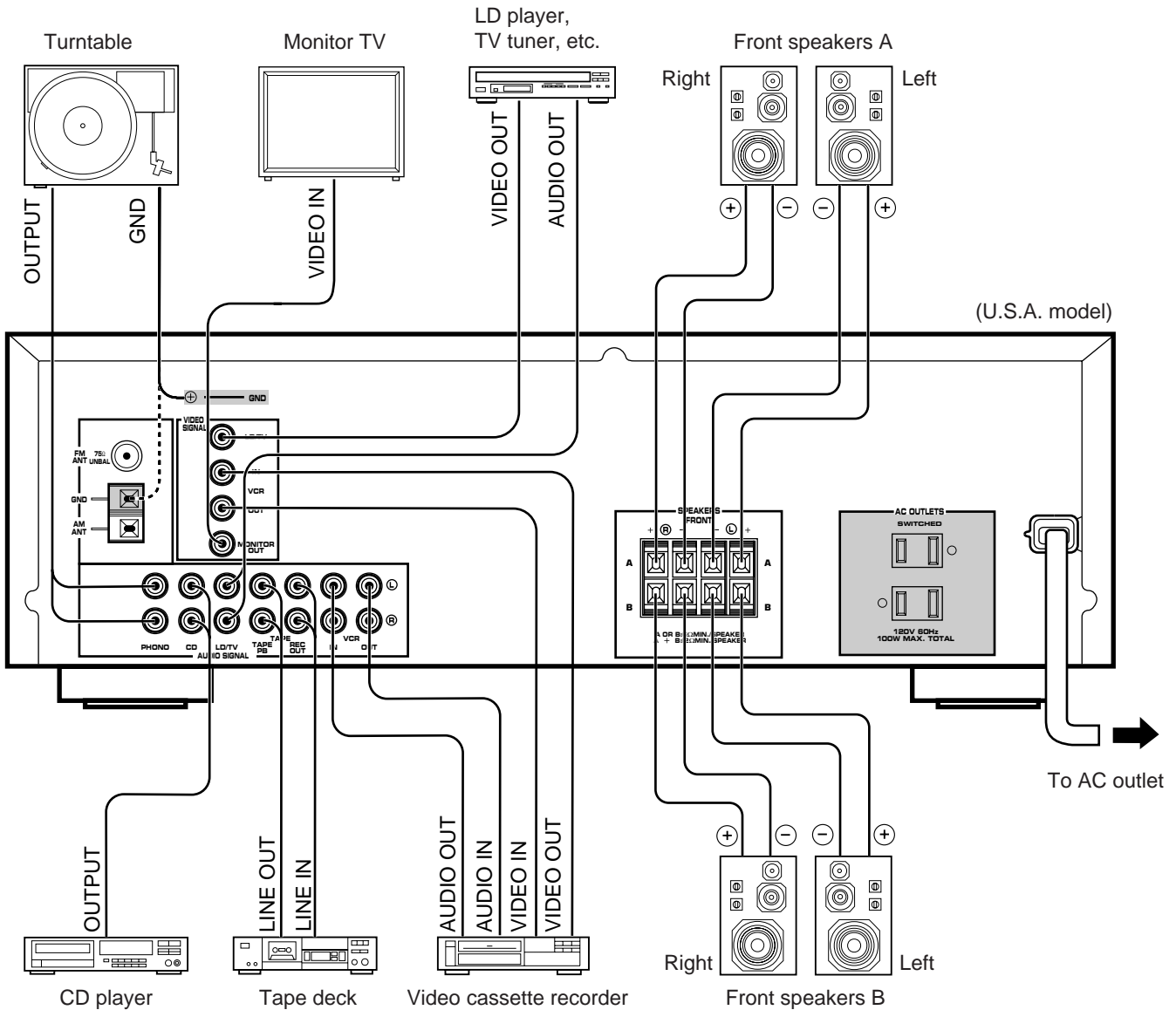

☐ : Refer to “ABOUT THE ACCESSORY TERMINALS” on page 9.

Note on front speaker connection:

One or two speaker systems can be connected to this unit. If you connect only one speaker system, connect it to either the **SPEAKERS A** or **B** terminals..

Center and rear speakers

Connect the respective speakers to this unit as figured below.

RX-V490

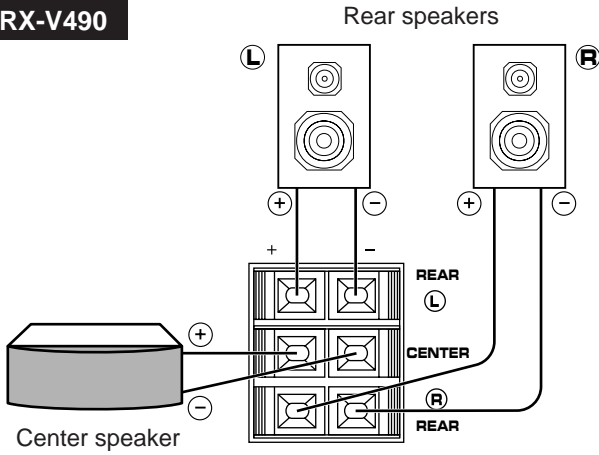

RX-V390

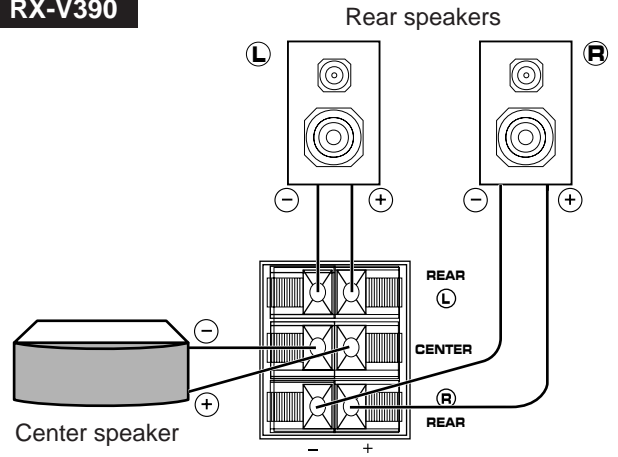

Only one rear speaker can also be used in place of two rear speakers.

For connecting one rear speaker, follow the method shown below.

Rear speaker

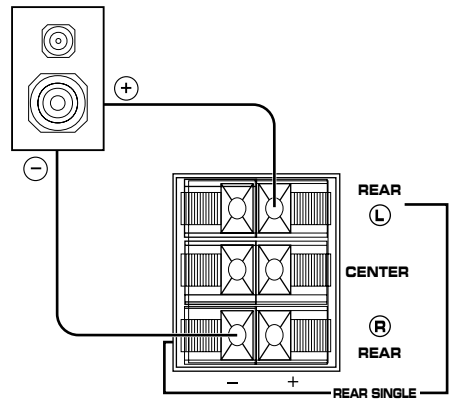

For connecting speakers

Connect the **SPEAKERS** terminals to your speakers with wire of the proper gauge, cut as short as possible. If the connections are faulty, no sound will be heard from the speakers. Make sure that the polarity of the speaker wires is correct, that is, + and – markings are observed. If these wires are reversed, the sound will be unnatural and will lack bass.

Do not let the bare speaker wires touch each other and do not let them touch the metal parts of this unit as this could damage this unit and/or speakers.

Note

Use speakers with the specified impedance shown on the rear of this unit.

How to Connect:

Red: positive (+)
Black: negative (-)

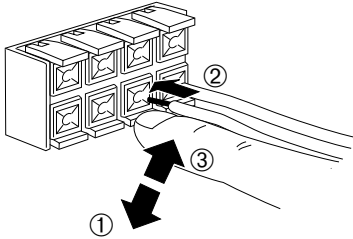

- ① Press and open the tab.
- ② Insert the bare wire.
[Remove approx. 5mm (1/4") insulation from the speaker wires.]
- ③ Press the tab back to the original position and secure the wire.

RX-V390 only

For connecting to the REAR and CENTER SPEAKERS terminals

Red: positive (+)
Black: negative (-)

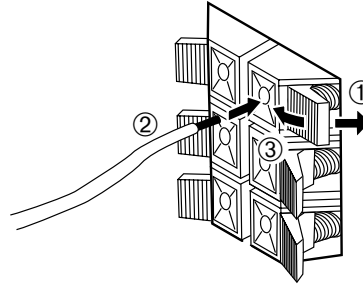

- ① Press the tab.
- ② Insert the bare wire.
[Remove approx. 5mm (1/4") insulation from the speaker wires.]
- ③ Release the tab and secure the wire.

ABOUT THE ACCESSORY TERMINALS

AC OUTLET(S) (SWITCHED)

(U.S.A., Canada and General models)

..... 2 SWITCHED OUTLETS
(Australia model) 1 SWITCHED OUTLET

Use these to connect the power cords from your components to this unit.

The power to the **SWITCHED** outlets is controlled by this unit's **POWER** switch or the provided remote control transmitter's **POWER** key. These outlets will supply power to any component whenever this unit is turned on.

The maximum power (total power consumption of components) that can be connected to the **SWITCHED AC OUTLET(S)** is 100 watts.

GND terminal (For turntable use)

Connecting the ground wire of the turntable to the **GND** terminal will normally minimize hum, but in some cases better results may be obtained with the ground wire disconnected. Use one of the two **GND** terminals on the rear of this unit for the connection.

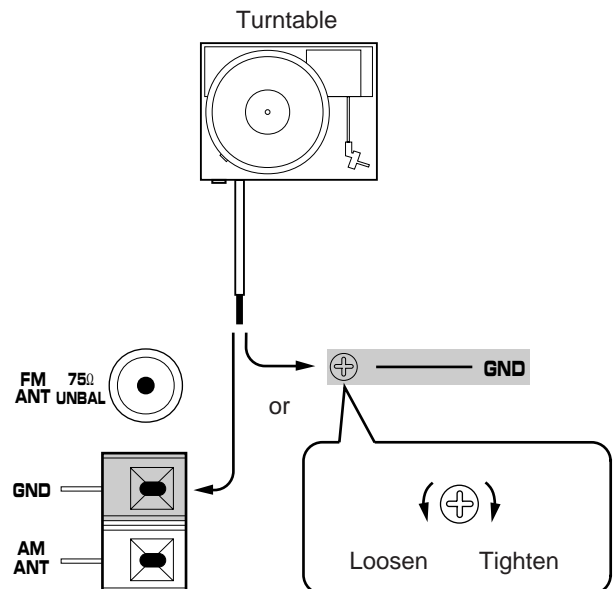

ANTENNA CONNECTIONS

- Each antenna should be connected to the designated terminals correctly, referring to the following diagram.
- Both AM and FM indoor antennas are included with this unit. In general, these antennas will probably provide sufficient signal strength. Nevertheless, a properly installed outdoor antenna will give clearer reception than an indoor one. If you experience poor reception quality, an outdoor antenna may result in improvement.

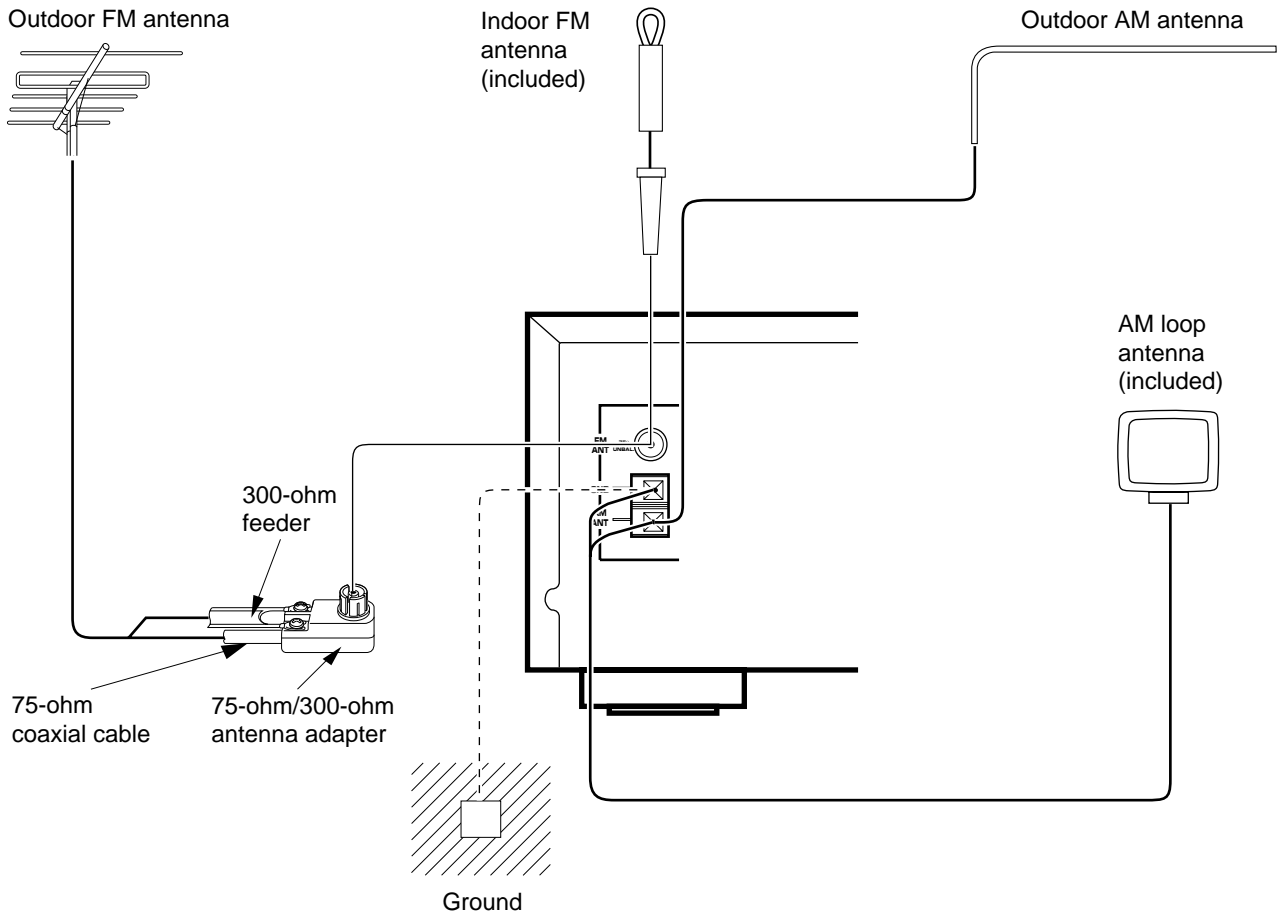

Connecting the AM loop antenna

1

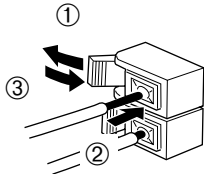

2

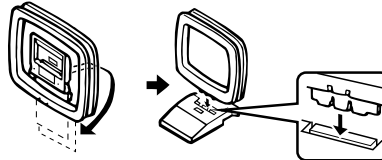

3



Orient so that the best reception is obtained.

- * The AM loop antenna should be placed apart from the main unit. The antenna may be hung on a wall.
- * The AM loop antenna should be kept connected, even if an outdoor AM antenna is connected to this unit.

GND terminal

For maximum safety and minimum interference, connect the **GND** terminal to a good earth ground. A good earth ground is a metal stake driven into moist earth.

Notes

- When connecting the indoor FM antenna, insert its connector into the **FM ANT** terminal firmly.
- If you need an outdoor FM antenna to improve FM reception quality, either 300-ohm feeder or coaxial cable may be used. In locations troubled by electrical interference, coaxial cable is preferable.

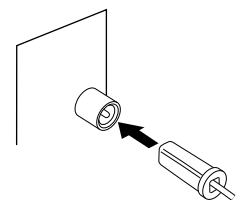

SPEAKER BALANCE ADJUSTMENT

This procedure lets you adjust the sound output level balance between the front, center, and rear speakers using the built-in test tone generator. With this adjustment, the sound output level heard at the listening position will be the same from each speaker. This is important for the best performance of the digital sound field processor.

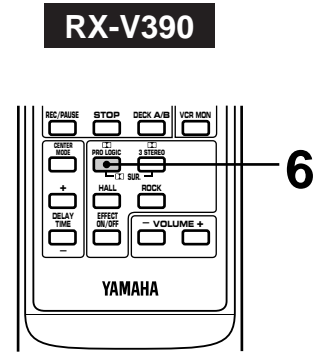
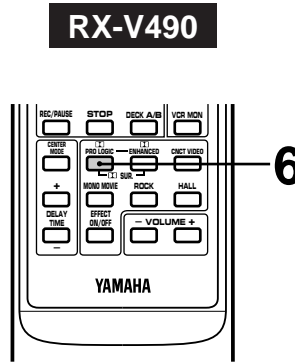
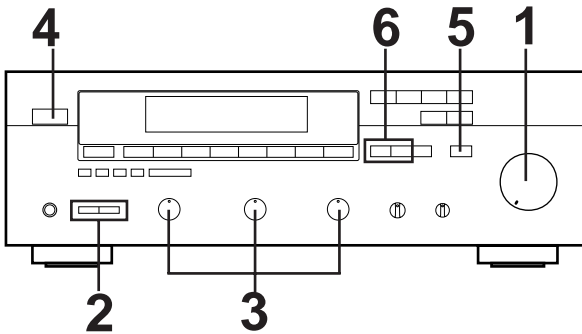

1

Set to the "∞" position.

2 Select the front speakers to be used.

SPEAKERS

A	B
ON	ON
OFF	OFF

* If you use two front speaker systems, press both the A and B switches.

3

Set to the "0" position.

4 Turn the power on.

5 Turn the DSP on, so that a program name appears on the display.

6 Select PRO LOGIC, so that the corresponding name is illuminated on the display.

CONTINUED

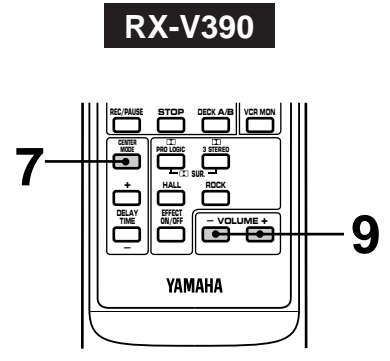
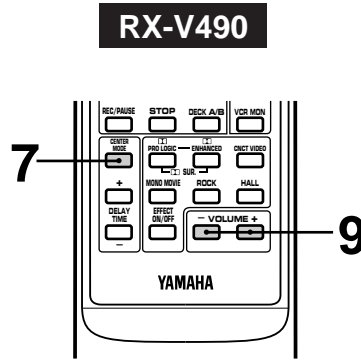
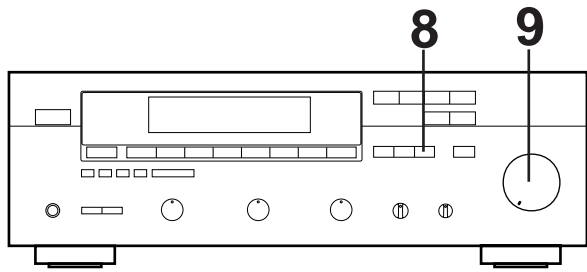

7 Select the center channel output mode according to your speaker configuration.
(Refer to “**SPEAKER CONFIGURATION**” on page 6.)

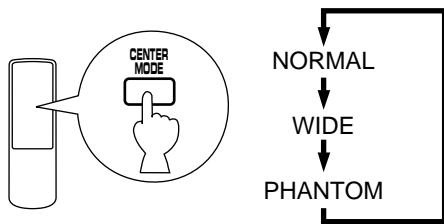

On the feature of each mode, refer to the “**Note**” shown below.

Note

In step 7, when you select the center channel output mode, note the following.

For 5 speaker configuration)

NORMAL: Select this mode when you use a center speaker that is smaller than the front speakers. In this mode, the bass tone will be output from the front speakers.

WIDE: Select this mode when you use the center speaker approximately same sized as the front speakers.

For 4 speaker configuration)

PHANTOM: Select this mode when you do not use the center speaker. The center sound will be output from the left and right front speakers.

*** RX-V390 only**

When the **DOLBY 3 STEREO** program is used, the **PHANTOM** mode cannot be selected.

8

TEST



Flashes continuously.

9

Turn up the volume.

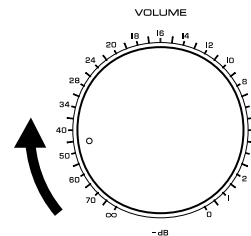

You will hear a test tone (like pink noise) from the left front speaker, then the center speaker, then the right front speaker, and then the rear speakers, for about two seconds each. The display changes as shown below.

RX-V490

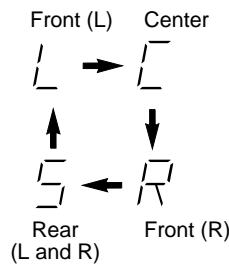

RX-V390

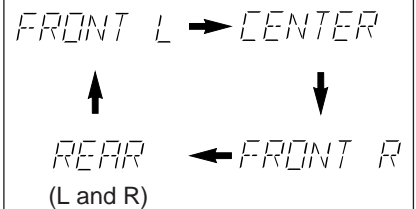

* The test tone from the left rear speaker and the right rear speaker will be heard at the same time.

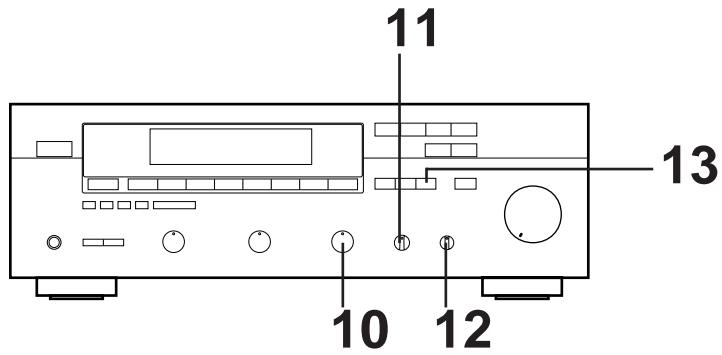

10 Adjust the **BALANCE** control so that the effect sound output level of the left front speaker and the right front speaker are the same.



11 Adjust the sound output level of the center speaker to be at the same level as that of the front speakers with the **CENTER LEVEL** control.



12 Adjust the sound output level of the rear speakers to be at the same level as that of the front speakers with the **REAR LEVEL** control.



13 Cancel the test tone.

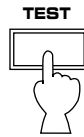

“TEST” stops flashing and disappears.

Notes

- Once you have completed these adjustments, you can adjust whole sound level on your audio system by using the **VOLUME** control (or the **VOLUME** keys on the remote control transmitter).
- If you use external power amplifiers, their volume controls may also be adjusted to achieve proper balance.
- In step 11, if the center channel mode is in the “**PHANTOM**” position, the sound output level of the center speaker cannot be adjusted. This is because in this mode, the center sound is automatically output from the left and right front speakers.

BASIC OPERATIONS

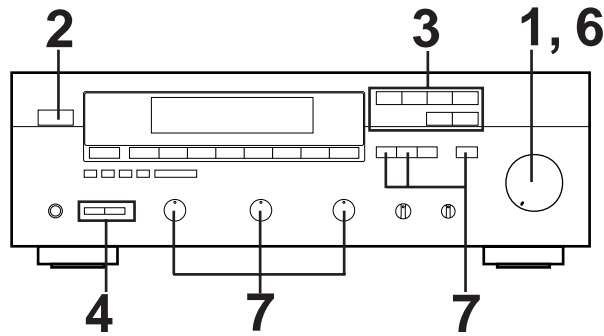

TO PLAY A SOURCE

1

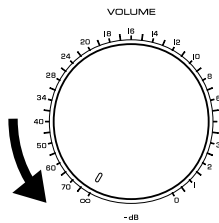

Set to the "∞" position.

2 Turn the power on.

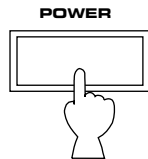

3 Select the desired input source by using the input selector buttons.
(For video sources, turn the TV/monitor ON.)

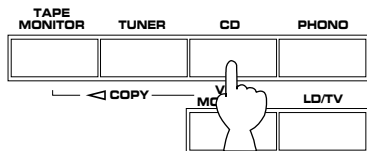

* The name of the selected input source will appear in the display.

4 Select the front speakers to be used.

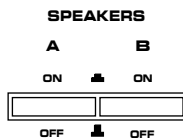

* If you use two front speaker systems, press both the A and B switches.

5 Play the source. (For detailed information on the tuning operation, refer to page 17.)

6

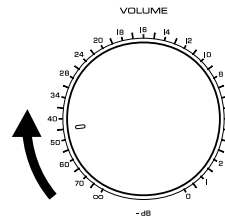

Adjust to the desired output level.

7 If desired, adjust the **BASS, TREBLE, BALANCE** controls, etc. (refer to page 16) and use the digital sound field processor. (Refer to page 23.)

Notes on using the input selector buttons

- Note that pressing on each input selector button selects the source which is connected to the corresponding input terminals on the rear panel.
- The selection of **TAPE MONITOR** or **VCR MONITOR** cannot be canceled by pressing another input selector button. To cancel, press it again.
- In step 3, if two or more program sources are selected at the same time, be sure to remember the priority order of the input sources.

Priority order of sources: 1) **TAPE MONITOR**, 2) **VCR MONITOR**, 3) **LD/TV**, **TUNER**, **CD** or **PHONO**.

- * If you select **LD/TV**, **TUNER**, **CD** or **PHONO**, be sure that neither **TAPE MONITOR** nor **VCR MONITOR** have been selected.
- * If you select **TAPE MONITOR** and **VCR MONITOR** and another input selector button at the same time, the playback result will be the video image from the VCR and the sound from the audio tape.
- * If you select both **LD/TV** and **TAPE MONITOR** at the same time, the playback result will be the video image from the LD player and the sound from the audio tape.
- * Once you play the LD player, its video image will not be interrupted even if other input selector buttons except **VCR MONITOR** are selected.

To turn off the power

Press the **POWER** switch again.

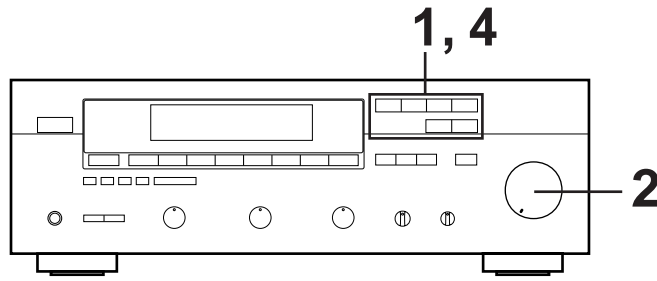

TO RECORD A SOURCE TO TAPE (OR DUB FROM TAPE TO TAPE)

1 Select the source to be recorded.

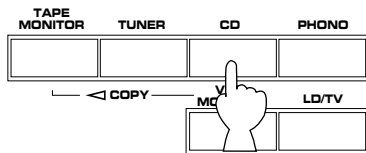

- * To dub from tape to tape, refer to the “Notes” shown at right.
- * When you select **LD/TV**, **TUNER**, **CD** or **PHONO**, make sure that neither **TAPE MONITOR** nor **VCR MONITOR** is also selected.

2 Play the source and then turn the **VOLUME** control up to confirm the input source. (For detailed information on the tuning operations, refer to the page 17.)

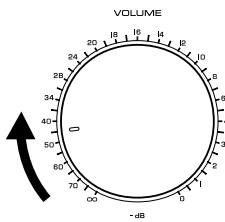

3 Set the tape deck or VCR to the recording mode.

4 To monitor the audio and/or video signals being recorded, press the input selector button for the tape deck or VCR used to make the recording.

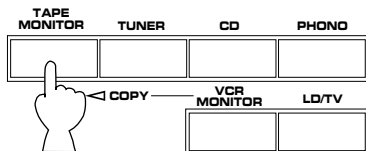

Notes

- To dub from tape to tape, only the following method of dubbing can be performed.

SOURCE	RECORDER
VCR (or tape deck) connected to the VCR terminals.	→ Tape deck connected to the TAPE terminals.

- The DSP, **VOLUME**, **BASS**, **TREBLE** and **BALANCE** control settings have no effect on the material being recorded.

Selecting the SPEAKER system

Because one or two speaker systems (as front speakers) can be connected to this unit, the **SPEAKERS** switches allow you to select speaker system **A** or **B**, or both at once.

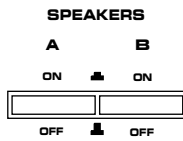

Adjusting the BALANCE control

Adjust the balance of the output volume to the left and right speakers to compensate for sound imbalance caused by speaker location or listening room conditions.



Note

This control is effective only for the sound from the front speakers.

Adjusting the BASS and TREBLE controls

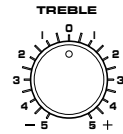

BASS : Turn this clockwise to increase (or counter-clockwise to decrease) the low frequency response.

TREBLE : Turn this clockwise to increase (or counter-clockwise to decrease) the high frequency response.

Note

These controls are effective only for the sound from the front speakers.

When you listen with headphones

Connect the headphones to the **PHONES** jack. You can listen to the sound to be output from the front speakers through headphones.

When listening with headphones privately, set both the **SPEAKERS A** and **B** switches to the **OFF** position and switch off the digital sound field processor (so that no DSP program name is illuminated on the display) by pressing the **EFFECT** switch.

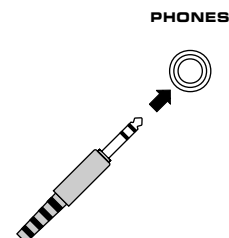

TUNING OPERATIONS

Normally, if station signals are strong and there is no interference, quick automatic-search tuning (AUTOMATIC TUNING) is possible. However, if signals of the station you want to select are weak, you must tune to it manually (MANUAL TUNING).

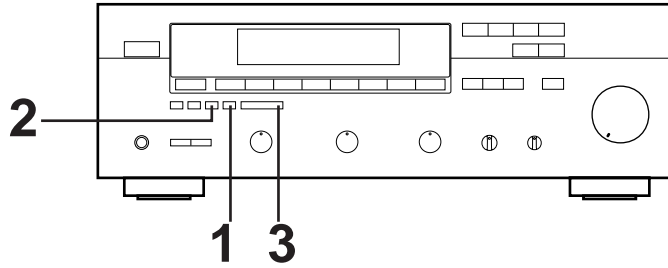

AUTOMATIC TUNING

- 1 Select the reception band (FM or AM) while watching the display.



- 2 Press the TUNING MODE button (AUTO/ON/OFF) to start automatic tuning.

- 3 Use the DOWN TUNING UP slider to manually tune to a desired station.
 - To tune to a higher frequency, press the right side once.
 - To tune to a lower frequency, press the left side once.
 - * If the station where tuning search stops is not the desired one, press again.
 - * If the tuning search does not stop at the desired station (because the signals of the station are weak), change to the MANUAL TUNING method.

MANUAL TUNING

- 1 Select the reception band (FM or AM) while watching the display.



- 2 Press the TUNING MODE button (AUTO/ON/OFF) to stop automatic tuning.

- 3 Use the DOWN TUNING UP slider to manually tune to a desired station.
 - * To continue tuning search, press and hold the button.

Note
If you tune to an FM station manually, it is received in monaural mode automatically to increase the signal quality.

Display information

RX-V490

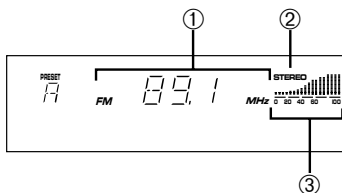

- ① Displays the band and frequency of the received station.
- ② Lights up when an FM stereo broadcast is received in stereo.
- ③ Indicates the signal level of the received station.

RX-V390

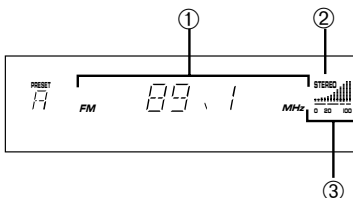

PRESET TUNING

MANUAL PRESET TUNING

This unit can store station frequencies (selected by tuning operation) by using the preset station buttons. With this function, you can select any desired station by only pressing the corresponding preset station button. Up to 40 stations (8 stations x 5 pages) can be stored.

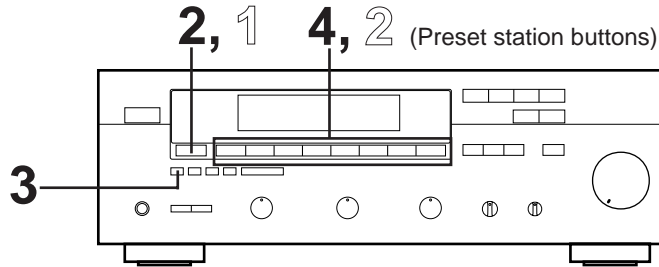

To store stations

1 Tune to a desired station.
(Refer to the previous page for tuning procedure.)

2 Select a desired page (A – E) of preset station buttons while watching the display.

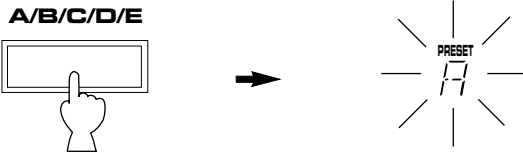

3

MEMORY

MANUAL FM

MEMORY

Flashes on and off for about 5 seconds.

4 Press a preset station button before “MEMORY” goes off from the display.

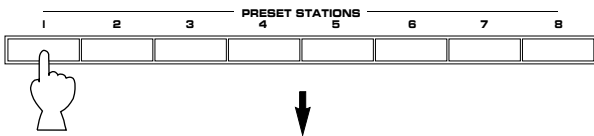

RX-V490



RX-V390

Shows the displayed station has been programmed to A1.

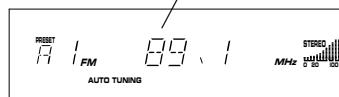

- * In the same way, program other stations to A2, A3 ... A8.
- * You can program more stations to the preset station buttons on other pages in the same way by selecting other pages in step 2.

To recall a preset station

1 Select the page of preset station buttons.

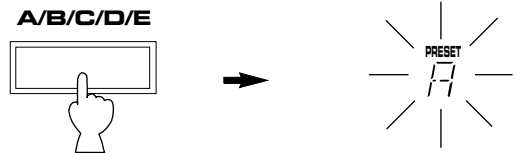

2 Select the desired preset station button.

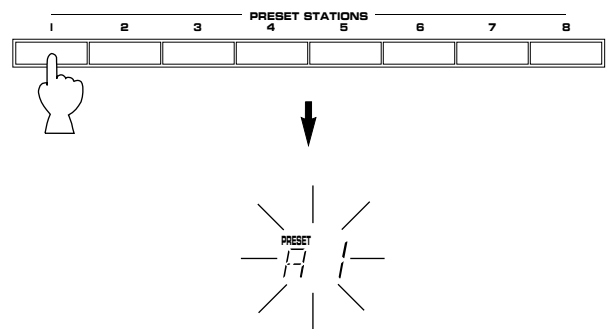

Notes

- A new setting can be programmed in place of the former one.
- For presets, the setting of the reception mode (stereo or monaural) is stored along with the station frequency.

Memory back-up



The memory back-up circuit prevents the programmed data from being lost even if the **POWER** switch is set off or the power plug is disconnected from the AC outlet or the power is cut due to temporary power failure. If, however, the power is cut for more than one week, the memory may be erased. If so, it can be re-programmed by simply following the PRESET TUNING steps.

AUTOMATIC PRESET TUNING

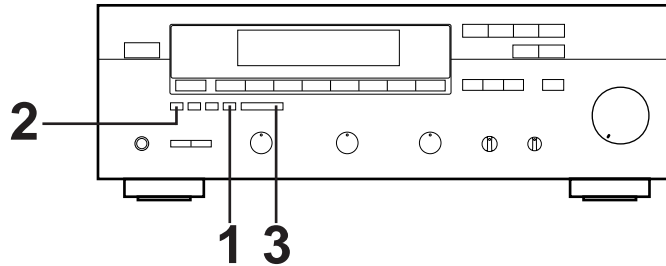
You can also make use of an automatic preset tuning function for FM stations only. By this function, this unit performs automatic tuning and stores FM stations with strong signals sequentially. Up to 40 stations are stored automatically in the same way as in the manual preset tuning method on page 18.

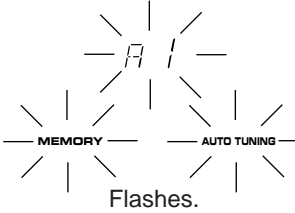
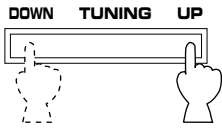

To store stations

1	 → 
2	 →  <p style="text-align: center;">Flashes.</p> <p>Press and hold for about 3 seconds.</p>
3	 <p>DOWN TUNING UP</p> <p>To tune to higher frequencies, press right side once. To tune to lower frequencies, press left side once. * If the TUNING button is not pressed, in a while, the automatic preset tuning begins automatically toward higher frequencies.</p> <p>The automatic preset tuning begins from the frequency currently displayed. Received stations are programmed to A1, A2 ... A8 sequentially. * If more than 8 stations are received, they are also programmed to the preset station numbers on other pages (B, C, D and E) in that order.</p>

When the automatic preset tuning is finished

The display shows the frequency of the last preset station. Check the contents and the number of preset stations by following the procedure of the section "To recall a preset station" on page 18.

To recall a preset station

Simply follow the procedure of the section "To recall a preset station" on page 18.

Notes

- You can replace a preset station by another FM or AM station manually by simply following the procedure of the section "To store stations" on page 18.
- If the number of received stations is not enough to be stored up to E8, the search is finished automatically after searching through all frequencies.
- With this function, only FM stations with sufficient signal strength are stored automatically. If the station you want to program is weak in signal strength, tune to it in monaural manually and program it by following the procedure of the section "To store stations" on page 18.

If you want to store the first station received by the automatic preset tuning to a desired preset station number.

If, for example, you want to store the first received station to C5, select "C5" by using the **A/B/C/D/E** button and the preset station buttons after pressing the **MEMORY** button in step 2. Then press the **TUNING** button. The first received station is stored to C5, and next stations to C6, C7 ... sequentially. If stations are stored up to E8, the automatic preset tuning is finished automatically.

EXCHANGING PRESET STATIONS

You can exchange the places of two preset stations with each other as shown below.

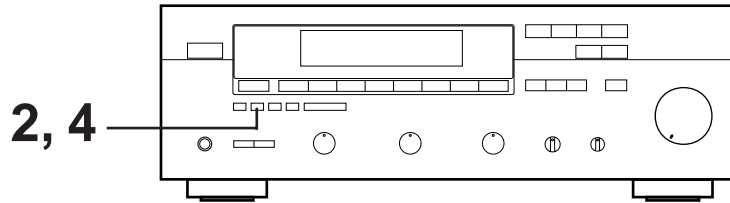

Example)

If you want to shift the preset station on E1 to A5, and vice versa.

<p>1 Recall the preset station on E1 (by following the method of "To recall a preset station" on page 18).</p>	<p>4</p> <p>EDIT</p> <p>RX-V490 RX-V390</p> <p>E 1 - - A 5 E 1 - - A 5</p> <p>Shows the exchange of stations is completed.</p>
<p>2</p> <p>EDIT</p> <p>→</p> <p>E 1</p> <p>MEMORY</p> <p>Flashes</p>	
<p>3 Next, recall the preset station on A5 by following the same method with step 1.</p> <p>A 5</p> <p>MEMORY</p> <p>Flashes</p>	

USING DIGITAL SOUND FIELD PROCESSOR (DSP)

This unit incorporates a sophisticated, multi-program digital sound field processor, which allows you to expand and shape the audio sound field from both the audio and video sources, for a theater-like experience in the listening/viewing room.

RX-V490

This digital sound field processor has 6 programs; 4 programs for digital sound field processing and 2 programs for the Dolby Pro Logic Surround sound system (**DOLBY PRO LOGIC** and **DOLBY PRO LOGIC ENHANCED**). You can create an excellent audio sound field by selecting the suitable program and adding desired adjustments. In addition, when the **DOLBY PRO LOGIC** or **DOLBY PRO LOGIC ENHANCED** program is selected, the built-in automatic input balance control functions. This presents you the best surround condition without manual adjustment.

RX-V390

This digital sound field processor has 4 programs; 2 programs for digital sound field processing and 2 programs for the Dolby Pro Logic Surround sound system (**DOLBY PRO LOGIC** and **DOLBY 3 STEREO**). You can create an excellent audio sound field by selecting the suitable program and adding desired adjustments. In addition, when the **DOLBY PRO LOGIC** or **DOLBY 3 STEREO** program is selected, the built-in automatic input balance control functions. This presents you the best surround condition without manual adjustment.

Front Panel

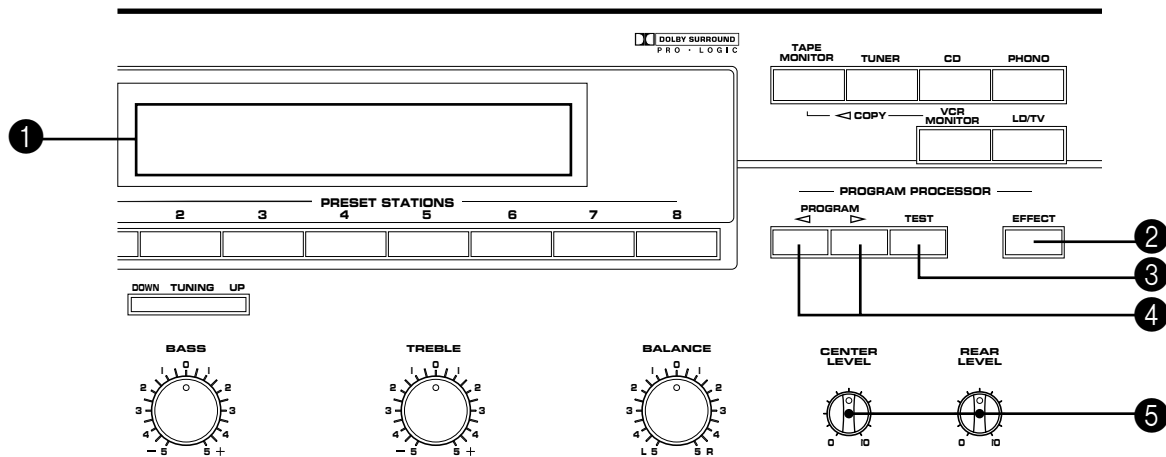

Remote Control Transmitter

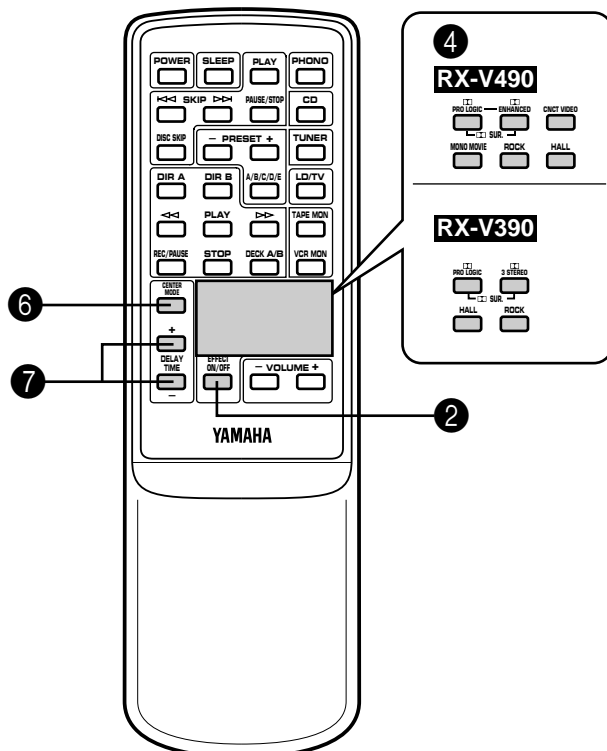



- 1 Displays your selection on the DSP or other information.
- 2 **EFFECT**
Switches on/off the digital sound field processor (DSP).
- 3 **TEST**
Used for speaker balance adjustment. (For details, refer to page 11, 12 and 13.)
- 4 Select a digital sound field program.
- 5 **CENTER LEVEL -/+**
REAR LEVEL -/+
Adjust sound output level at each speaker. (For details, refer to page 24.)
- 6 **CENTER MODE**
Selects the center channel output mode. (For details, refer to page 12.)
- 7 **DELAY TIME -/+**
Adjust the delay time. (For details, refer to page 25.)

Description of Each Sound Field Program

The following list gives brief descriptions of the sound fields produced by each of the DSP programs. Keep in mind that some of these are precise digital recreations of actual acoustic environments. The data for them was recorded at actual places using sophisticated sound field measurement equipment.

Note

The channel level balance between the left rear effect speaker and the right rear effect speaker may vary depending on the sound field you are listening to. This is due to the fact that some of these sound field recreations are actual acoustic environments.

PROGRAM	FEATURE	
 PRO LOGIC	This program is effective for playback of sources encoded with Dolby Surround. Compared to the conventional 3-channel surround-sound system, the true center channel is added, thus even further expanding the width of the surround-sound effect.	
RX-V490 only	 PRO LOGIC ENHANCED	This program is effective for playback of sources encoded with Dolby Surround. Enhancing the "Normal" Dolby Pro Logic, the DSP technology simulates the multi-surround speaker systems of a 35 mm film theater, thus widening the surrounded-sound field with greater presence.
	CONCERT VIDEO	This program is effective for music videos and gives excellent depth and clarity for vocals. For opera, the orchestra and stage are ideally recreated, letting you feel as if you were in an actual concert hall.
	MONO MOVIE	This program is designed specifically to enhance mono source programs. Compared to a strictly mono setting, the sound image created in this mode is wider and slightly forward of the speaker pair, lending an immediacy to the overall sound. It is particularly effective when used with old mono movies, news broadcasts and dialog.
RX-V390 only	 3 STEREO	This program is effective not only for playback of sources encoded with Dolby Surround, but also for sources not encoded with Dolby Surround or TV programs with 2-channel stereo sound. With this program, 2-channel stereo sound is converted into 3-channels (left front, center and right front), so the dialogs are emphasized on the center position by the use of the center speaker. As no sound is output from the rear speakers, this program is also effective in a simple Audio/Video system without rear speakers.
ROCK (CONCERT)	This program is suitable for rock music. A big, powerful sound is reproduced lively and dynamically.	
(CONCERT) HALL	In this program, the center seems deep behind the front speaker pair, creating an expansive, large hall ambience.	

Description of Dolby Pro Logic Surround

 **DOLBY PRO LOGIC SURROUND:** This unit employs the Dolby Pro Logic Surround system. This system is similar to professional Dolby Stereo decoders used in movie theaters. By employing a four-channel system, the Dolby Pro Logic Surround system divides the input signals into four levels: the left and right main channels, the center channel (to characterize dialog), and the rear surround-sound channels (to characterize sound effects, background noise and other ambient noise).

Dolby Surround is encoded on the sound track of commercially available video cassettes and video discs as well. When you play a source encoded with Dolby Surround on your home video system, the Dolby Pro Logic Surround system in this unit decodes the signal and feeds the surround-sound effects. The Dolby Pro Logic Surround mode may not be always effective on video sources not encoded with Dolby Surround.

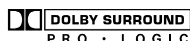

Manufactured under license from Dolby Laboratories Licensing Corporation. Additionally licensed under Canadian patent number 1,037,877. "Dolby", "Pro Logic", and the double-D symbol are trademarks of Dolby Laboratories Licensing Corporation.

To play a source with the digital sound field processor

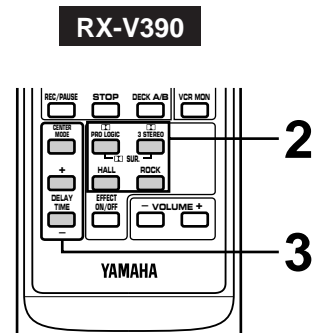
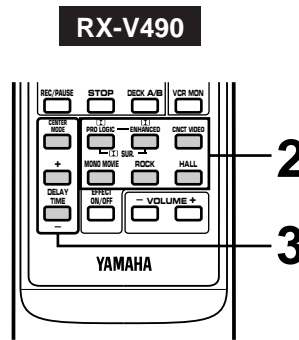
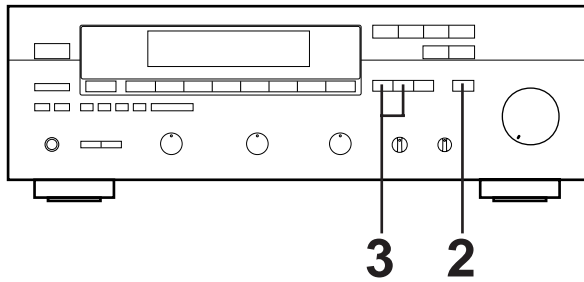

1 Follow steps 1 – 6 shown in “**BASIC OPERATIONS**” on page 14.

2 Turn the DSP on, so that a program name appears on the display.

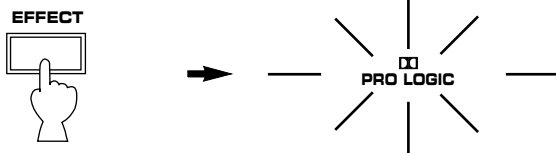

3 Select the desired program that is suitable for the source.

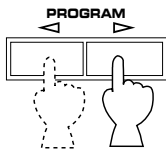

The selected program name is shown on the display.

4 If desired, adjust the delay time and the output level of each speaker. (For details, refer to the corresponding descriptions on 24 and 25.)

Notes

- If you prefer to cancel the DSP, press the **EFFECT** switch. The sound will be the normal 2-channel stereo without surround sound effect.
- When this unit's Dolby Pro Logic Surround system is used, if the main-source sound is considerably altered by overadjustment of the **BASS** or **TREBLE** controls, the relationship between the center and rear channels may produce an unnatural effect.

RX-V490

- When **CONCERT VIDEO**, **MONO MOVIE**, **ROCK CONCERT** or **CONCERT HALL** is selected, no sound is heard from the center speaker.
- When a monaural sound source is played with **DOLBY PRO LOGIC** or **DOLBY PRO LOGIC ENHANCED**, no sound is heard from the front speakers and the rear speakers. Sound is heard only from the center speaker. However, if the center channel mode is in **PHANTOM**, the front speakers output the sound of the center channel.

RX-V390

- When **ROCK** or **HALL** is selected, no sound is heard from the center speaker.
- When a monaural sound source is played with **DOLBY PRO LOGIC** or **DOLBY 3 STEREO**, no sound is heard from the front speakers and the rear speakers. Sound is heard only from the center speaker. For **DOLBY PRO LOGIC** only, however, if the center channel mode is in **PHANTOM**, the front speakers output the sound of the center channel.

Adjustment of the CENTER LEVEL

If desired, you can adjust the sound output level of the center speaker even if the output level is already set in “**SPEAKER BALANCE ADJUSTMENT**” on page 13.



- If no program is used, this adjustment is useless.

RX-V490

- If the digital sound field program **CONCERT VIDEO, MONO MOVIE, ROCK CONCERT** or **CONCERT HALL** is selected, this adjustment is useless.
- Once the output level is adjusted, the level value will be the same in the **DOLBY PRO LOGIC** and **DOLBY PRO LOGIC ENHANCED** programs.

RX-V390

- If the digital sound field program **ROCK** or **HALL** is selected, this adjustment is useless.
- Once the output level is adjusted, the level value will be the same in the **DOLBY PRO LOGIC** and **DOLBY 3 STEREO** programs.

Adjustment of the REAR LEVEL

If desired, you can adjust the sound output level of the rear speakers even if the output level is already set in “**SPEAKER BALANCE ADJUSTMENT**” on page 13.



- If no program is used, this adjustment is useless.

RX-V490

- Once the output level is adjusted, the level value will be the same in all the programs.

RX-V390

- If the program **DOLBY 3 STEREO** is selected, this adjustment is useless.
- Once the output level is adjusted, the level value will be the same in the **DOLBY PRO LOGIC, ROCK** and **HALL** programs.

Adjustment of DELAY TIME

You can adjust the time difference between the beginning of the source sound and the beginning of the effect sound with the **DELAY TIME** keys.

By applying more or less delay, sound effects, background noise, and ambient noise coming at you from the rear speakers can be enhanced or subdued for extra effect.

RX-V490

- PRO LOGIC** : from 15 to 30 milliseconds
(Preset value: 20 milliseconds)
- PRO LOGIC ENHANCED** : from 15 to 30 milliseconds
(Preset value: 20 milliseconds)
- CONCERT VIDEO** : from 1 to 100 milliseconds
(Preset value: 25 milliseconds)
- MONO MOVIE** : from 1 to 100 milliseconds
(Preset value: 25 milliseconds)
- ROCK CONCERT** : from 1 to 100 milliseconds
(Preset value: 15 milliseconds)
- CONCERT HALL** : from 1 to 100 milliseconds
(Preset value: 30 milliseconds)

RX-V390

- PRO LOGIC** : from 15 to 30 milliseconds
(Preset value: 20 milliseconds)
- ROCK** : from 5 to 60 milliseconds
(Preset value: 20 milliseconds)
- HALL** : from 5 to 60 milliseconds
(Preset value: 20 milliseconds)

- When **DOLBY 3 STEREO** is selected, this adjustment cannot be made.

- By continuously pressing “+” or “-” key, the value changes continuously.

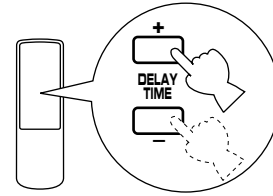

RX-V490

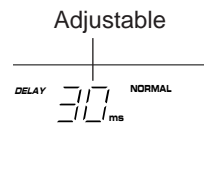

RX-V390

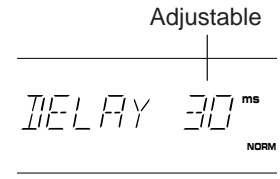

Notes

- Adding too much delay will cause an unnatural effect with some sources. Experiment with the **DELAY TIME** keys to create the effect that you find most suitable.
- The values of the **DELAY TIME** you set the last time will remain memorized even when the power of this unit is off. However, if the power cord is kept disconnected for more than one week, these values will be automatically changed back to the original factory settings.

RX-V390

- When the **DELAY TIME** key is pressed, the sound is momentarily interrupted.

SETTING THE SLEEP TIMER

If you use the SLEEP timer of this unit, you can make this unit turn off automatically. When you are going to sleep while enjoying a broadcast or other desired input source, this timer function is helpful.

Notes

- The SLEEP timer can be controlled only with the remote control transmitter.
- The components on which the SLEEP timer is effective are the sources connected to the **SWITCHED AC OUTLET(S)** on the rear panel of this unit.

To set the SLEEP time

1

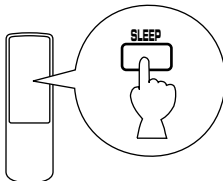

Press once or more to select the desired SLEEP time.

RX-V490 **RX-V390**

Indicates the SLEEP time.

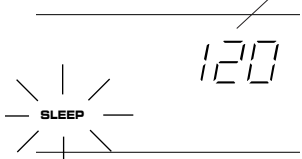

Flashes.



Lights up.

Whenever the **SLEEP** key is pressed, the SLEEP time will change as follows.

(Minutes)

120 → 90 → 60 → 30

The SLEEP timer is off (OFF).
(The state before the **SLEEP** key is pressed.)

After a while, the display returns to the indication before the SLEEP timer is set, and the "SLEEP" indicator is illuminated.

2 The unit will be turned off automatically at the selected SLEEP time.

To cancel the selected SLEEP time

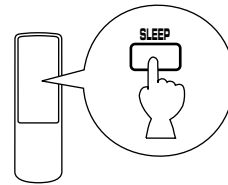

RX-V490

Press once or more so that the display returns to the indication before the SLEEP timer is set. ("SLEEP" will go off from the display.)

RX-V390

Press once or more so that "SLEEP OFF" appears on the display. (It will soon disappear and the "SLEEP" indicator will go off from the display.)

Note

The SLEEP timer setting can also be canceled by turning off the power with the **POWER** switch or disconnecting the power plug of this unit from the AC outlet.

REMOTE CONTROL TRANSMITTER

The remote control transmitter provided with this unit is designed to control all the most commonly used functions of the unit. If the CD player and tape deck connected to this unit are YAMAHA components, then this remote control transmitter will also control various functions of each component.

KEY FUNCTIONS

For Control of This Unit

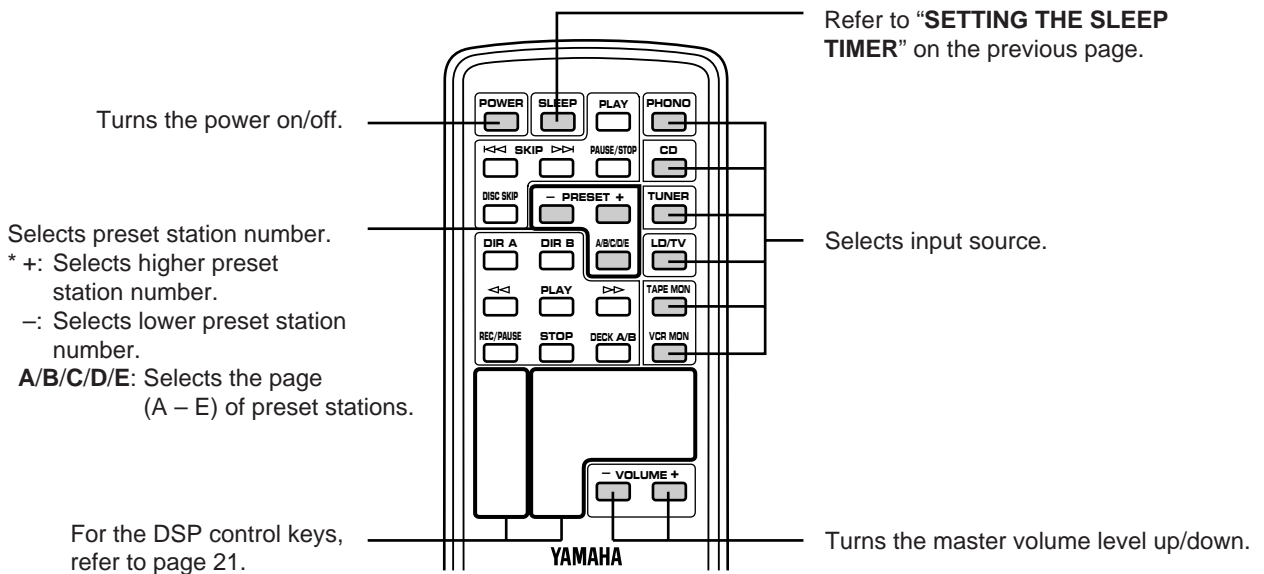

For Other Component Control

Identify the remote control transmitter keys with your component's keys. If these keys are identical, their function will be the same. On each key function, refer to the corresponding instruction on your component's manual.

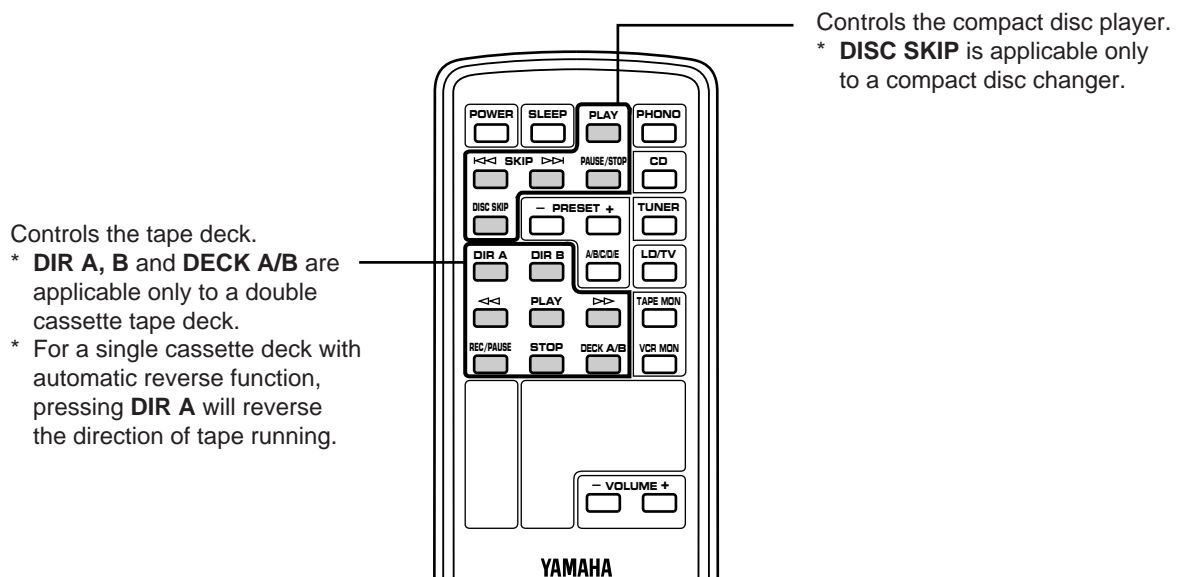

NOTES ABOUT THE REMOTE CONTROL TRANSMITTER

Battery installation

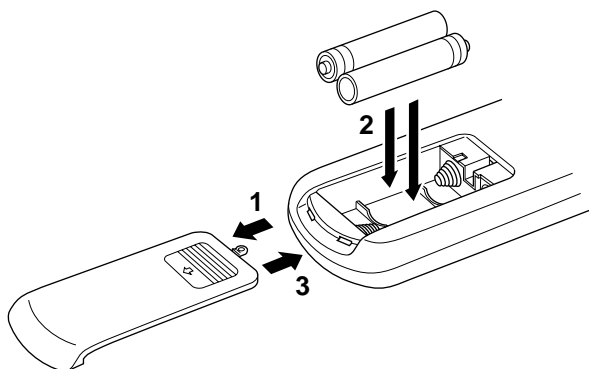

Battery replacement

If you find that the remote control transmitter must be used closer to the main unit, the batteries are weak. Replace both batteries with new ones.

Notes

- Use only AA, R6, UM-3 batteries for replacement.
- Be sure the polarities are correct. (See the illustration inside the battery compartment.)
- Remove the batteries if the remote control transmitter will not be used for an extended period of time.
- If batteries leak, dispose of them immediately. Avoid touching the leaked material or letting it come in contact with clothing, etc. Clean the battery compartment thoroughly before installing new batteries.

Remote control transmitter operation range

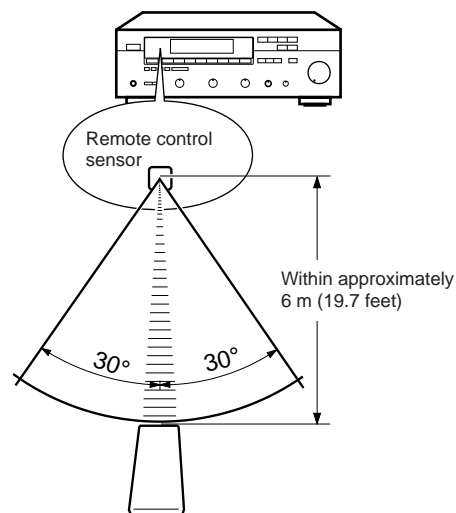

Notes

- There should be no large obstacles between the remote control transmitter and the main unit.
- If the remote control sensor is directly illuminated by strong lighting (especially an inverter type of fluorescent lamp etc.), it might cause the remote control transmitter not to work correctly. In this case, reposition the main unit to avoid direct lighting.

TROUBLESHOOTING

If the unit fails to operate normally, check the following points to determine whether the fault can be corrected by the simple measures suggested. If it cannot be corrected, or if the fault is not listed in the SYMPTOM column, disconnect the power cord and contact your authorized YAMAHA dealer or service center for help.

	SYMPTOM	CAUSE	REMEDY
Amplifier	The unit fails to turn on when the POWER switch is pressed.	Power cord is not plugged in or is not completely inserted.	Firmly plug in the power cord.
	No sound or no picture.	Incorrect output cord connections.	Connect the cords properly. If the problem persists, the cords may be defective.
		Appropriate input selector is not pressed.	Press the appropriate input selector corresponding to the input source.
	The sound suddenly goes off.	The protection circuit has been activated because of short circuit etc.	Turning the unit off and then on will reset the protection circuit.
		The SLEEP timer functioned.	Cancel the SLEEP timer function.
	Only one side speaker outputs the sound.	Incorrect setting of the BALANCE control.	Adjust it to the appropriate position.
		Incorrect cord connections.	Connect the cords properly. If the problem persists, the cords may be defective.
	Sound "hums".	Incorrect cord connections.	Firmly connect the audio plugs. If the problem persists, the cords may be defective.
		No connection from the turntable to the GND terminal.	Make the GND connection between the turntable and this unit.
	The volume level is low while playing a record.	The record is being played on a turntable with an MC cartridge.	The player should be connected to the unit through the MC head amplifier.
	The volume level cannot be increased, or sound is distorted.	The power to the component connected to the REC OUT terminals of this unit is off.	Turn the power to the component on.
	No sound from the rear speakers.	The sound output level to the rear speakers is set to 0.	Turn up the sound output level with the REAR LEVEL control.
		Incorrect sound field program selection.	Select the appropriate program.
		No sound field program is selected.	
No sound from the center speaker.	The sound output level to the center speaker is set to 0.	Turn up the sound output level with the CENTER LEVEL control.	
	The center channel mode is in PHANTOM mode.	Select NORMAL or WIDE.	
	Incorrect sound field program selection.	Select the appropriate program.	
	No sound field program is selected.		
FM	FM stereo reception is noisy.	Because of the characteristics of FM stereo broadcasts, this is limited to cases where the transmitter is too far away or the antenna input is poor.	Check the antenna connections. Try using a multiple element FM antenna.
	There is distortion and clear reception cannot be obtained even with a good FM antenna.	There is multipath interference.	Adjust antenna placement to eliminate multipath interference.
	A desired station cannot be tuned in with Auto tuning.	The station is too weak.	Use Manual tuning mode. Use a high quality directional FM antenna.
AM	A desired station cannot be tuned in with Auto tuning.	Weak signal or loose antenna connections.	Tighten the AM loop antenna connections and rotate it for best reception. Use Manual tuning mode.
	There are continuous crackling and hissing noises.	Noises will result from lightning, fluorescent lamps, motors, thermostats and other electrical equipment.	Use an outdoor antenna and a ground wire. This will help somewhat but it is difficult to eliminate all noise.
	There are buzzing and whining noises (especially in the evening).	A television set is being used nearby.	Relocate this unit away from the TV.
Remote control transmitter	The remote control transmitter does not work.	Direct sunlight or lighting (of an inverter type of fluorescent lamp etc.) is striking the remote control sensor of the main unit.	Change the position of the main unit.
		The batteries of this remote control transmitter are too weak.	Replace the batteries with new ones.
Others	The sound is degraded when monitoring is performed by using the headphones connected to the compact disc player or cassette deck which are connected with this unit.	The power to this unit is off.	Turn the power to this unit on.

SPECIFICATIONS

AUDIO SECTION

Minimum RMS Output Power per Channel	
<RX-V490>	
Front L, R	
8 ohms, 20 Hz to 20 kHz, 0.04% THD	70W+70W
Center	
8 ohms, 1 kHz, 0.1% THD	70W
Rear L, R	
8 ohms, 1 kHz, 0.7% THD	15W+15W
<RX-V390>	
Front L, R	
8 ohms, 20 Hz to 20 kHz, 0.04% THD	60W+60W
Center	
8 ohms, 1 kHz, 0.2% THD	60W
Rear	
8 ohms, 1 kHz, 0.7% THD	15W
Maximum Output Power [General model only]	
8 ohms, 1 kHz, 10% THD	
<RX-V490>	100W+100W
<RX-V390>	80W+80W
Dynamic Power per Channel	
(by IHF Dynamic Headroom measuring method)	
<RX-V490>	
8/6/4/2 ohms	90/105/130/150W
<RX-V390>	
[U.S.A. model]	
8/6/4/2 ohms	80/95/120/150W
[Canada model]	
8/6/4/2 ohms	75/95/115/130W
[Australia and General models]	
8/6/4/2 ohms	80/100/120/135W
Power Band Width	
8 ohms, 30W, 0.08% THD	10 Hz to 50 kHz
Damping Factor	
8 ohms, 20 Hz to 20 kHz	80 or more
Input Sensitivity/Impedance	
PHONO MM	2.5 mV/47 k-ohms
CD/TAPE/LD-TV/VCR	150 mV/47 k-ohms
Maximum Input Signal (1 kHz, 0.04% THD)	
PHONO MM	90 mV
Output Level/Impedance	
REC OUT	150 mV/0.6 k-ohms
Headphone Jack Rated Output/Impedance (RL = 8 ohms, 0.04% THD)	
<RX-V490>	
Output Level	0.56V
Impedance	330 ohms
<RX-V390>	
Output Level	0.51V
Impedance	330 ohms

Frequency Response (20 Hz to 20 kHz)	
CD/TAPE/LD-TV/VCR (FRONT L/R)	0±0.5 dB
RIAA Equalization Deviation	
PHONO MM	0±0.5 dB
Total Harmonic Distortion (EFFECT OFF)	
PHONO MM to REC OUT	
20 Hz to 20 kHz, 1V	0.02%
CD/TAPE/LD-TV/VCR to SP OUT	
20 Hz to 20 kHz, 30W/8 ohms	0.02%
Signal-to-Noise Ratio (IHF-A Network)	
PHONO MM (5 mV Input Shorted)	82 dB
CD/TAPE/LD-TV/VCR (Input Shorted)	93 dB
Residual Noise (IHF-A Network)	
FRONT L/R	140 µV
Channel Separation (Vol. -30 dB)	
PHONO MM (Input Shorted 1 kHz/10 kHz)	60 dB
CD/TAPE/LD-TV/VCR (Input 5.1 k-ohms Terminated 1 kHz/10 kHz)	60 dB
Tone Control Characteristics	
BASS: Boost/cut	±10 dB (50 Hz)
Turnover Frequency	(350 Hz)
TREBLE: Boost/cut	±10 dB (20 kHz)
Turnover Frequency	(3.5 kHz)
Gain Tracking Error (0 to -60 dB)	3 dB

VIDEO SECTION

Input Level/Impedance	1Vp-p/75 ohms
Output Level/Impedance	1Vp-p/75 ohms

FM SECTION

Tuning Range	
[U.S.A. and Canada models]	87.5 to 107.9 MHz
[Australia and General models]	87.5 to 108.0 MHz
50 dB Quieting Sensitivity (IHF, 75 ohms)	
Mono	1.55 µV (15.1 dBf)
Stereo	21 µV (37.7 dBf)
Usable Sensitivity (75 ohms)	
(30 dB S/N Quieting, 1 kHz, 100% mod.)	0.8 µV (9.3 dBf)
Image Response Ratio	45 dB
IF Response Ratio	80 dB
Spurious Response Ratio	70 dB
AM Suppression Ratio	55 dB
Capture Ratio	1.5 dB
Alternate Channel Selectivity	85 dB
Signal-to-Noise Ratio (IHF)	
Mono/Stereo	80 dB/75 dB
Harmonic Distortion (1 kHz)	
Mono/Stereo	0.1%/0.2%

Stereo Separation (1 kHz)	50 dB
Frequency Response	
30 Hz to 15 kHz	0 ±1.5 dB

AM SECTION

Tuning Range	
[U.S.A., Canada and General models]	530 to 1,710 kHz
[Australia model]	531 to 1,611 kHz
Usable Sensitivity	100 µV/m
Selectivity	32 dB
Signal-to-Noise Ratio	50 dB
Image Response Ratio	40 dB
Spurious Response Ratio	50 dB
Harmonic Distortion (1 kHz)	0.3%

AUDIO SECTION

Output Level/Impedance	
FM (100% mod., 1 kHz)	500 mV/2.2 k-ohms
AM (30% mod., 1 kHz)	150 mV/2.2 k-ohms

GENERAL

Power Supply	
[U.S.A. and Canada models]	AC 120V, 60 Hz
[Australia model]	AC 240V, 50 Hz
[General model]	AC 110/120/220/240V, 50/60 Hz
Power Consumption	
<RX-V490>	
[U.S.A. model]	240W
[Canada model]	250W/320 VA
[Australia and General models]	250W
<RX-V390>	
[U.S.A. model]	180W
[Canada model]	240W/290 VA
[Australia and General models]	190W
AC Outlets	
2 SWITCHED OUTLETS	
[U.S.A., Canada and General models]	100W max. total
1 SWITCHED OUTLET	
[Australia model]	100W max. total
Dimensions (W x H x D)	435 x 146 x 299 mm (17-1/8" x 5-3/4" x 11-3/4")
Weight	
<RX-V490>	8.5 kg (18 lbs 11 oz)
<RX-V390>	7.4 kg (16 lbs 4 oz)
Accessories	AM loop antenna Indoor FM antenna Remote control transmitter Batteries

Specifications are subject to change without notice.

YAMAHA

YAMAHA ELECTRONICS CORPORATION, USA 6660 ORANGETHORPE AVE., BUENA PARK, CALIF. 90620, U.S.A.
YAMAHA CANADA MUSIC LTD. 135 MILNER AVE., SCARBOROUGH, ONTARIO M1S 3R1, CANADA
YAMAHA ELECTRONIK EUROPA G.m.b.H. SIEMENSSTR. 22-34, D-25462 RELLINGEN BEI HAMBURG, F.R. OF GERMANY
YAMAHA ELECTRONIQUE FRANCE S.A. RUE AMBROISE CROIZAT BP70 CROISSY-BEAUBOURG 77312 MARNE-LA-VALLEE CEDEX02, FRANCE
YAMAHA ELECTRONICS (UK) LTD. YAMAHA HOUSE, 200 RICKMANSWORTH ROAD WATFORD, HERTS WD1 7JS, ENGLAND
YAMAHA SCANDINAVIA A.B. J A WETTERGRENS GATA 1, BOX 30053, 400 43 VÄSTRA FRÖLUNDA, SWEDEN
YAMAHA MUSIC AUSTRALIA PTY, LTD. 17-33 MARKET ST., SOUTH MELBOURNE, 3205 VIC., AUSTRALIA

YAMAHA CORPORATION
VS 95590