

DIGITAL PIANO

P - 95 B / P - 95 S

Owner's Manual
Mode d'emploi
Bedienungsanleitung
Manual de instrucciones
Руководство пользователя

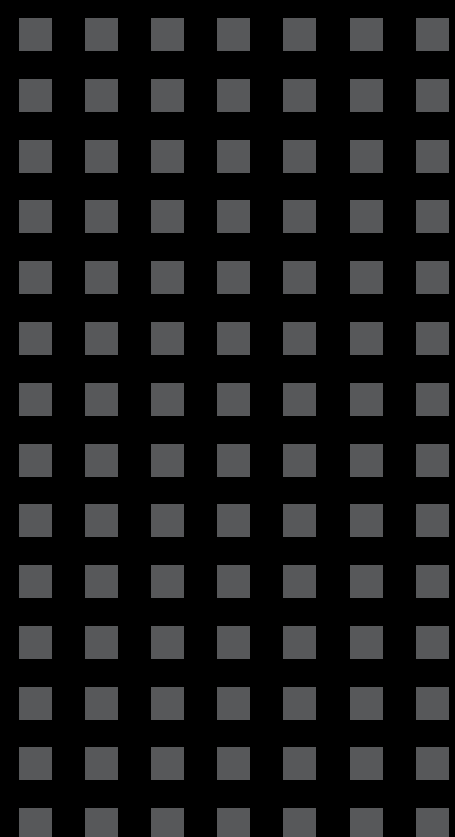

ENGLISH

FRANÇAIS

DEUTSCH

ESPAÑOL

РУССКИЙ

EN
FR
DE
ES
RU

SPECIAL MESSAGE SECTION

This product utilizes batteries or an external power supply (adapter). DO NOT connect this product to any power supply or adapter other than one described in the manual, on the name plate, or specifically recommended by Yamaha.

WARNING: Do not place this product in a position where anyone could walk on, trip over, or roll anything over power or connecting cords of any kind. The use of an extension cord is not recommended! If you must use an extension cord, the minimum wire size for a 25' cord (or less) is 18 AWG. NOTE: The smaller the AWG number, the larger the current handling capacity. For longer extension cords, consult a local electrician.

This product should be used only with the components supplied or; a cart, rack, or stand that is recommended by Yamaha. If a cart, etc., is used, please observe all safety markings and instructions that accompany the accessory product.

SPECIFICATIONS SUBJECT TO CHANGE:

The information contained in this manual is believed to be correct at the time of printing. However, Yamaha reserves the right to change or modify any of the specifications without notice or obligation to update existing units.

This product, either alone or in combination with an amplifier and headphones or speaker/s, may be capable of producing sound levels that could cause permanent hearing loss. DO NOT operate for long periods of time at a high volume level or at a level that is uncomfortable. If you experience any hearing loss or ringing in the ears, you should consult an audiologist.

IMPORTANT: The louder the sound, the shorter the time period before damage occurs.

Some Yamaha products may have benches and / or accessory mounting fixtures that are either supplied with the product or as optional accessories. Some of these items are designed to be dealer assembled or installed. Please make sure that benches are stable and any optional fixtures (where applicable) are well secured BEFORE using.

Benches supplied by Yamaha are designed for seating only. No other uses are recommended.

NOTICE:

Service charges incurred due to a lack of knowledge relating to how a function or effect works (when the unit is operating as designed) are not covered by the manufacturer's warranty, and are therefore the owners responsibility. Please study this manual carefully and consult your dealer before requesting service.

ENVIRONMENTAL ISSUES:

Yamaha strives to produce products that are both user safe and environmentally friendly. We sincerely believe that our products and the production methods used to produce them, meet these goals. In keeping with both the letter and the spirit of the law, we want you to be aware of the following:

Battery Notice:

This product MAY contain a small non-rechargeable battery which (if applicable) is soldered in place. The average life span of this type of battery is approximately five years. When replacement becomes necessary, contact a qualified service representative to perform the replacement.

This product may also use "household" type batteries. Some of these may be rechargeable. Make sure that the battery being charged is a rechargeable type and that the charger is intended for the battery being charged.

When installing batteries, never mix old batteries with new ones, and never mix different types of batteries. Batteries MUST be installed correctly. Mismatches or incorrect installation may result in overheating and battery case rupture.

Warning:

Do not attempt to disassemble, or incinerate any battery. Keep all batteries away from children. Dispose of used batteries promptly and as regulated by the laws in your area. Note: Check with any retailer of household type batteries in your area for battery disposal information.

Disposal Notice:

Should this product become damaged beyond repair, or for some reason its useful life is considered to be at an end, please observe all local, state, and federal regulations that relate to the disposal of products that contain lead, batteries, plastics, etc. If your dealer is unable to assist you, please contact Yamaha directly.

NAME PLATE LOCATION:

The name plate is located on the bottom of the product. The model number, serial number, power requirements, etc., are located on this plate. You should record the model number, serial number, and the date of purchase in the spaces provided below and retain this manual as a permanent record of your purchase.

Model

Serial No.

Purchase Date

PLEASE KEEP THIS MANUAL

FCC INFORMATION (U.S.A.)

1. IMPORTANT NOTICE: DO NOT MODIFY THIS UNIT!

This product, when installed as indicated in the instructions contained in this manual, meets FCC requirements. Modifications not expressly approved by Yamaha may void your authority, granted by the FCC, to use the product.

2. IMPORTANT:

When connecting this product to accessories and/or another product use only high quality shielded cables. Cable/s supplied with this product MUST be used. Follow all installation instructions. Failure to follow instructions could void your FCC authorization to use this product in the USA.

3. NOTE:

This product has been tested and found to comply with the requirements listed in FCC Regulations, Part 15 for Class "B" digital devices. Compliance with these requirements provides a reasonable level of assurance that your use of this product in a residential environment will not result in harmful interference with other electronic devices. This equipment generates/uses radio frequencies and, if not installed and used according to the instructions found in the users manual, may cause interference harmful to the operation of other electronic devices. Compliance with FCC regulations does

not guarantee that interference will not occur in all installations. If this product is found to be the source of interference, which can be determined by turning the unit "OFF" and "ON", please try to eliminate the problem by using one of the following measures:

Relocate either this product or the device that is being affected by the interference.

Utilize power outlets that are on different branch (circuit breaker or fuse) circuits or install AC line filter/s.

In the case of radio or TV interference, relocate/reorient the antenna. If the antenna lead-in is 300 ohm ribbon lead, change the lead-in to co-axial type cable.

If these corrective measures do not produce satisfactory results, please contact the local retailer authorized to distribute this type of product. If you can not locate the appropriate retailer, please contact Yamaha Corporation of America, Electronic Service Division, 6600 Orangethorpe Ave, Buena Park, CA90620

The above statements apply ONLY to those products distributed by Yamaha Corporation of America or its subsidiaries.

* This applies only to products distributed by YAMAHA CORPORATION OF AMERICA.

(class B)

OBSERVERA!

Apparaten kopplas inte ur växelströmskällan (nätet) så länge som den är ansluten till vägguttaget, även om själva apparaten har stängts av.

ADVARSEL: Netspændingen til dette apparat er IKKE afbrudt, så længe netledningen sidder i en stikkontakt, som er t endt — også selvom der er slukket på apparatets afbryder.

VAROITUS: Laitteen toisiopiiriin kytketty käyttökytökin ei irroita koko laitetta verkosta.

(standby)

IMPORTANT NOTICE FOR THE UNITED KINGDOM Connecting the Plug and Cord

IMPORTANT. The wires in this mains lead are coloured in accordance with the following code:

BLUE : NEUTRAL
BROWN : LIVE

As the colours of the wires in the mains lead of this apparatus may not correspond with the coloured markings identifying the terminals in your plug proceed as follows:

The wire which is coloured BLUE must be connected to the terminal which is marked with the letter N or coloured BLACK.

The wire which is coloured BROWN must be connected to the terminal which is marked with the letter L or coloured RED.

Making sure that neither core is connected to the earth terminal of the three pin plug.

• This applies only to products distributed by Yamaha-Kemble Music (U.K.) Ltd.

(2 wires)

PRECAUTIONS

PLEASE READ CAREFULLY BEFORE PROCEEDING

* Please keep this manual in a safe place for future reference.

WARNING

Always follow the basic precautions listed below to avoid the possibility of serious injury or even death from electrical shock, short-circuiting, damages, fire or other hazards. These precautions include, but are not limited to, the following:

Power supply/AC power adaptor

- Do not place the power cord near heat sources such as heaters or radiators, and do not excessively bend or otherwise damage the cord, place heavy objects on it, or place it in a position where anyone could walk on, trip over, or roll anything over it.
- Only use the voltage specified as correct for the instrument. The required voltage is printed on the name plate of the instrument.
- Use the specified adaptor (page 31) only. Using the wrong adaptor can result in damage to the instrument or overheating.
- Check the electric plug periodically and remove any dirt or dust which may have accumulated on it.

Do not open

- This instrument contains no user-serviceable parts. Do not open the instrument or attempt to disassemble or modify the internal components in any way. If it should appear to be malfunctioning, discontinue use immediately and have it inspected by qualified Yamaha service personnel.

Water warning

- Do not expose the instrument to rain, use it near water or in damp or wet conditions, or place containers on it containing liquids which might spill into any openings. If any liquid such as water seeps into the instrument, turn off the power immediately and unplug the power cord from the AC outlet. Then have the instrument inspected by qualified Yamaha service personnel.
- Never insert or remove an electric plug with wet hands.

Fire warning

- Do not put burning items, such as candles, on the unit. A burning item may fall over and cause a fire.

If you notice any abnormality

- When one of the following problems occur, immediately turn off the power switch and disconnect the electric plug from the outlet. Then have the device inspected by Yamaha service personnel.
 - The power cord or plug becomes frayed or damaged.
 - It emits unusual smells or smoke.
 - Some object has been dropped into the instrument.
 - There is a sudden loss of sound during use of the instrument.

CAUTION

Always follow the basic precautions listed below to avoid the possibility of physical injury to you or others, or damage to the instrument or other property. These precautions include, but are not limited to, the following:

Power supply/AC power adaptor

- Do not connect the instrument to an electrical outlet using a multiple-connector. Doing so can result in lower sound quality, or possibly cause overheating in the outlet.
- When removing the electric plug from the instrument or an outlet, always hold the plug itself and not the cord. Pulling by the cord can damage it.
- Remove the electric plug from the outlet when the instrument is not to be used for extended periods of time, or during electrical storms.

Location

- Do not place the instrument in an unstable position where it might accidentally fall over.
- Before moving the instrument, remove all connected cables.
- When setting up the product, make sure that the AC outlet you are using is easily accessible. If some trouble or malfunction occurs, immediately turn off the power switch and disconnect the plug from the outlet. Even when the power switch is turned off, electricity is still flowing to the product at the minimum level. When you are not using the product for a long time, make sure to unplug the power cord from the wall AC outlet.
- Use only the stand specified for the instrument. When attaching the stand or rack, use the provided screws only. Failure to do so could

cause damage to the internal components or result in the instrument falling over.

Connections

- Before connecting the instrument to other electronic components, turn off the power for all components. Before turning the power on or off for all components, set all volume levels to minimum.
- Be sure to set the volumes of all components at their minimum levels and gradually raise the volume controls while playing the instrument to set the desired listening level.

Handling caution

- Do not insert a finger or hand in any gaps on the instrument.
- Never insert or drop paper, metallic, or other objects into the gaps on the panel or keyboard.
- Do not rest your weight on, or place heavy objects on the instrument, and do not use excessive force on the buttons, switches or connectors.
- Do not use the instrument/device or headphones for a long period of time at a high or uncomfortable volume level, since this can cause permanent hearing loss. If you experience any hearing loss or ringing in the ears, consult a physician.

Yamaha cannot be held responsible for damage caused by improper use or modifications to the instrument, or data that is lost or destroyed.

Always turn the power off when the instrument is not in use.

Even when the [⏻] (Standby/On) switch is in the "Standby" position, electricity is still flowing to the instrument at the minimum level. When you are not using the instrument for a long time, make sure you unplug the power cord from the wall AC outlet.

NOTICE

To avoid the possibility of damage to the product, data or other property, follow the notices below.

■ Handling and Maintenance

- Do not use the instrument in the vicinity of a TV, radio, stereo equipment, mobile phone, or other electric devices. Otherwise, the instrument, TV, or radio may generate noise.
- Do not expose the instrument to excessive dust or vibrations, or extreme cold or heat (such as in direct sunlight, near a heater, or in a car during the day) to prevent the possibility of panel disfiguration or damage to the internal components.
- Do not place vinyl, plastic or rubber objects on the instrument, since this might discolor the panel or keyboard.
- When cleaning the instrument, use a soft, dry/cloth. Do not use paint thinners, solvents, cleaning fluids, or chemical-impregnated wiping cloths.

■ Saving data

- Some data will be saved to internal memory of the instrument. The data is maintained even when the power is turned off. Saved data may be lost due to malfunction or incorrect operation. Save important data to a computer (page 25).

Information

■ About copyrights

- Copying of the commercially available musical data including but not limited to MIDI data and/or audio data is strictly prohibited except for your personal use.
- This product incorporates and bundles computer programs and contents in which Yamaha owns copyrights or with respect to which it has license to use others' copyrights. Such copyrighted materials include, without limitation, all computer software, style files, MIDI files, WAVE data, musical scores and sound recordings. Any unauthorized use of such programs and contents outside of personal use is not permitted under relevant laws. Any violation of copyright has legal consequences. **DON'T MAKE, DISTRIBUTE OR USE ILLEGAL COPIES.**

■ About this manual

- The illustrations as shown in this manual are for instructional purposes only, and may appear somewhat different from those on your instrument.
- For the sake of simplicity, both models P-95B and P-95S are hereafter referred to in this Owner's Manual as P-95.
- The company names and product names in this manual are the trademarks or registered trademarks of their respective companies.

The serial number of this product may be found on the bottom of the unit. You should note this serial number in the space provided below and retain this manual as a permanent record of your purchase to aid identification in the event of theft.

Model No.

Serial No.

(bottom)

Information for Users on Collection and Disposal of Old Equipment

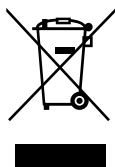

This symbol on the products, packaging, and/or accompanying documents means that used electrical and electronic products should not be mixed with general household waste.

For proper treatment, recovery and recycling of old products, please take them to applicable collection points, in accordance with your national legislation and the Directives 2002/96/EC.

By disposing of these products correctly, you will help to save valuable resources and prevent any potential negative effects on human health and the environment which could otherwise arise from inappropriate waste handling.

For more information about collection and recycling of old products, please contact your local municipality, your waste disposal service or the point of sale where you purchased the items.

[For business users in the European Union]

If you wish to discard electrical and electronic equipment, please contact your dealer or supplier for further information.

[Information on Disposal in other Countries outside the European Union]

This symbol is only valid in the European Union. If you wish to discard these items, please contact your local authorities or dealer and ask for the correct method of disposal.

(weee_eu)

Introduction

*Thank you for purchasing the Yamaha P-95B/P-95S!
We recommend that you read this manual carefully
so that you can fully take advantage of the advanced and
convenient functions of the P-95B/P-95S.
We also recommend that you keep this manual in a safe and
handy place for future reference.*

Main Features

■ Graded Hammer Standard Keyboard

Thanks to our experience as the world's leading manufacturer of acoustic pianos, we've developed a keyboard with action that's virtually indistinguishable from the real thing. Just as on a traditional acoustic piano, the keys of the lower notes have a heavier touch, while the higher ones are more responsive to lighter playing. The keyboard's sensitivity can even be adjusted to match your playing style. This Graded Hammer technology also enables the P-95 to provide authentic touch in a lightweight instrument.

■ AWM Stereo Sampling

This instrument offers unmatched sonic realism and natural grand-piano type playability as well as Yamaha's original "AWM Stereo Sampling" tone-generation technology for rich, musical voices.

In particular, the Grand Piano 1 and 2 voices feature samples painstakingly recorded from a full concert grand piano, while the Electric Piano 1 and 2 voice features multiple samples for different velocities (Dynamic Sampling); in other words, it uses different samples depending on the strength of your playing.

Accessories

- Owner's Manual
- AC Power Adaptor
 - * May not be included depending on your particular area. Please check with your Yamaha dealer.
- Footswitch
- Music Rest
- My Yamaha Product User Registration
 - * The PRODUCT ID on the sheet will be needed when you fill out the User Registration form.

Table of Contents

PRECAUTIONS	4
-------------------	---

Introduction

Main Features.....	6
Accessories	6
Panel Controls and Terminals.....	8
Before Using.....	9
Turning the Power On	9
Setting the Volume	9
Using the Pedal.....	10
Using Headphones	11
Music Rest.....	11

Reference

Listening to the Demo Songs	12
Listening to the Piano Preset Songs.....	13
Using the Metronome.....	14
Setting the Time Signature.....	14
Adjusting the Tempo.....	14
Adjusting the Volume	15
Selecting & Playing Voices.....	16
Selecting Voices	16
Combining Voices (Dual).....	17
Adding Variations to the Sound – Reverb	18
Transposition.....	19
Fine tuning of the Pitch.....	19
Touch Sensitivity	20
Recording Your Performance	21
Recording a performance.....	21
Play back the recorded performance	22
Changing the Settings of the Recorded Data	23
Connecting MIDI Instruments	24
About MIDI.....	24
Connecting a Personal Computer	24
Transferring Backup Data between the Computer and the Instrument	25
Initializing the Settings.....	25
MIDI Functions	26
MIDI Transmit/Receive Channel Selection	26
Local Control ON/OFF	26
Program Change ON/OFF	27
Control Change ON/OFF	27
Troubleshooting.....	28
Optional Equipment.....	28

Appendix

Preset Song List.....	30
Specifications	31

Quick Operation Guide	32
-----------------------------	----

This is a quick reference for operation of the functions assigned to the buttons and keyboard.

Online Materials (Downloadable from the web)

The following instructional materials are available for downloading from the Yamaha Manual Library. Access the Yamaha Manual Library, then enter your model name (P-95, for example) in the Model Name area to search the manuals.

Yamaha Manual Library

<http://www.yamaha.co.jp/manual/>

• Data List

The Data List contains MIDI related information, such as the MIDI Data Format and MIDI Implementation chart.

• MIDI Basics

If you want to know more about MIDI and how to use it, refer to this introductory book.

Panel Controls and Terminals

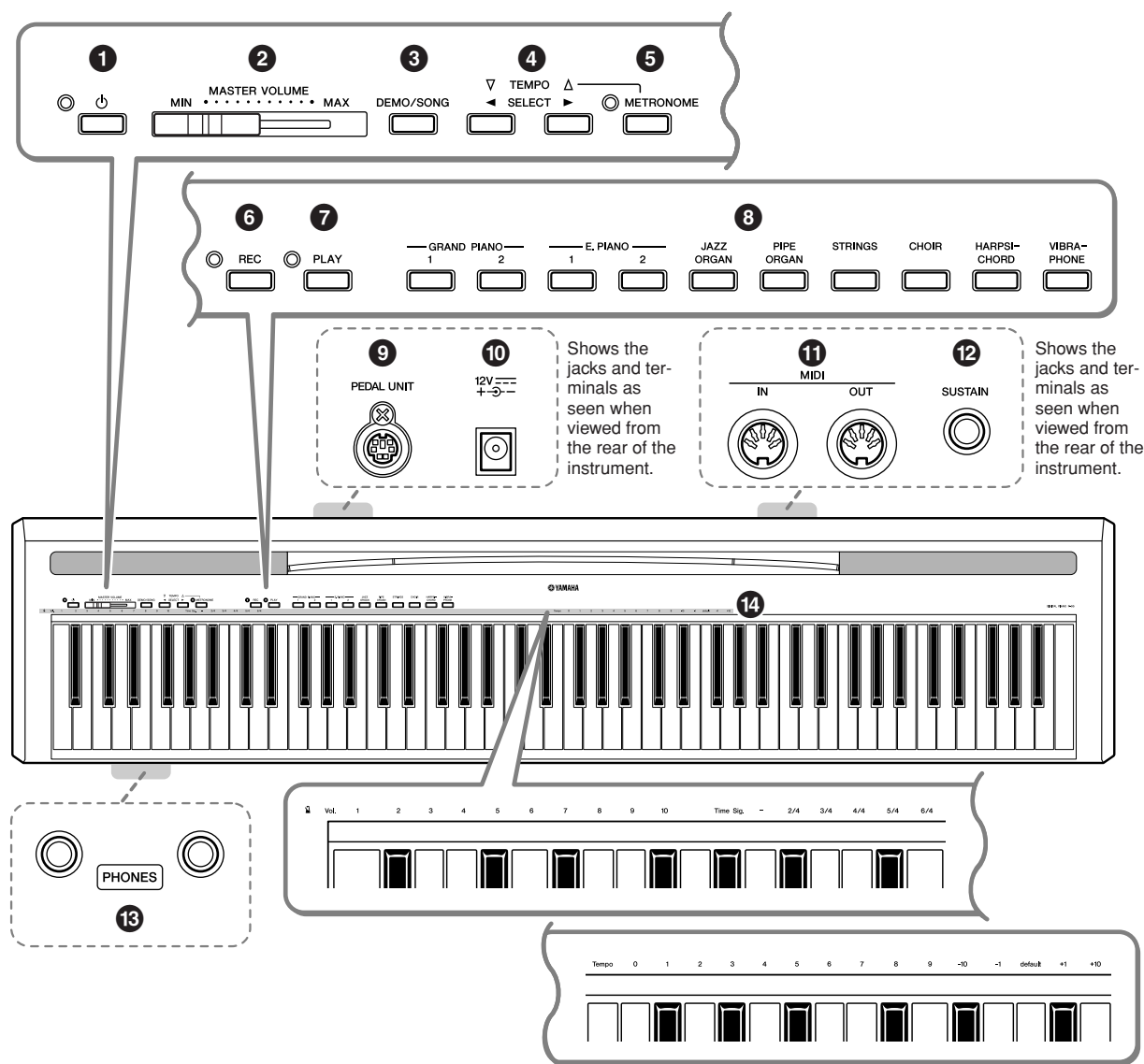

- 1** [⏻] (Standby/On) switch page 9
For turning the power on or off.
- 2** [MASTER VOLUME] slider page 9
For adjusting the volume level of the entire sound.
- 3** [DEMO/SONG] button pages 12, 13
For playing the demo songs and the piano preset songs.
- 4** TEMPO [▽] [△]/SELECT [◀] [▶] buttons pages 12, 13
While playing a voice demo or piano preset song, pressing these buttons lets you select the next or previous song. These buttons can also be used to change the song tempo.
- 5** [METRONOME] button page 14
For using the metronome.
- 6** [REC] button page 21
For recording your keyboard performance.
- 7** [PLAY] button page 22
For playing back the recorded performance.
- 8** VOICE buttons page 16
For selecting voices from 10 internal sounds including Grand Piano 1 and 2. You can also combine two voices and use them together.
- 9** [PEDAL UNIT] jack page 10
For connecting an optional pedal unit (LP-5A).
- 10** DC IN jack page 9
For connecting the power adaptor.
- 11** MIDI [IN] [OUT] terminals page 24
For connecting external MIDI devices, allowing the use of various MIDI functions.
- 12** [SUSTAIN] jack page 10
For connecting an included pedal, optional FC3 foot pedal or FC4 foot switch.
- 13** [PHONES] jack page 11
For connecting a set of standard stereo headphones, allowing private practice.
- 14** Metronome indication page 14
Indicates the keys used for making metronome settings.

Before Using

Turning the Power On

1. Connect the AC adaptor to the power supply jack.

⚠ WARNING

Use the specified adaptor (page 31) only. The use of other adaptors may result in irreparable damage to both the adaptor and the instrument.

2. Plug the AC adaptor into an AC outlet.

⚠ CAUTION

Unplug the AC Power Adaptor when not using the instrument, or during electrical storms.

3. Press the [⏻] (Standby/On) switch to turn on the power.

The power indicator located to the left of the [⏻] (Standby/On) switch lights up.

Pressing the switch again turns the power off.

⚠ CAUTION

Even when the instrument is turned off, electricity is still flowing to the instrument at the minimum level. When you are not using the instrument for a long time, make sure you unplug the AC power adaptor from the wall AC outlet.

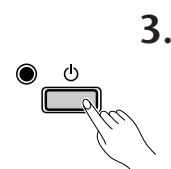
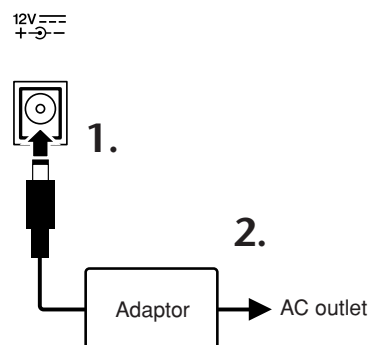

Setting the Volume

Initially set the [MASTER VOLUME] slider about halfway between the “MIN” and “MAX” settings. Then, when you start playing, re-adjust the [MASTER VOLUME] slider to the most comfortable listening level.

TERMINOLOGY

MASTER VOLUME:

The volume level of the entire keyboard sound



← The level decreases. → The level increases.

Using the Pedal

[SUSTAIN] jack

This jack is for connecting the included pedal. The pedal functions in the same way as a damper pedal on an acoustic piano. Connect an optional pedal to this jack and press the pedal to sustain the sound.

An optional FC3 foot pedal or FC4 foot switch can also be connected to this jack.

If you connect an optional pedal of FC3, the half pedal function* can be used.

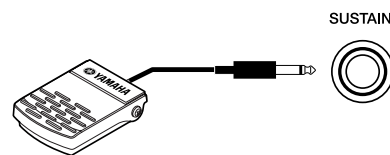

* half pedal function

While you playing the piano with SUSTAIN and if you need to delete the cloudy sound, release the foot from pedal to half position.



Do not press the footswitch while turning the power on. Doing this changes the recognized polarity of the footswitch, resulting in reversed footswitch operation.

[PEDAL UNIT] jack

This jack is for connecting an optional LP-5A pedal unit. When connecting the pedal unit, make sure to also assemble the unit on an optional keyboard stand (L-85/L-85S).

PEDAL UNIT

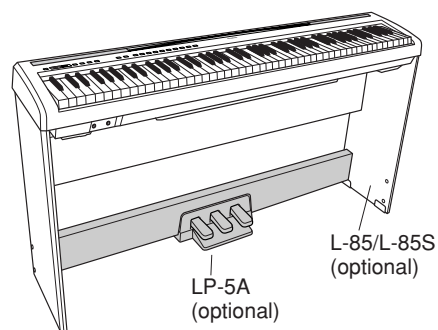
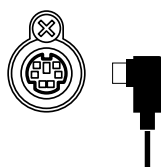

Make sure that power is OFF when connecting or disconnecting the pedal.

Pedal Unit Functions

The optional pedal unit has three foot pedals that produce a range of expressive effects similar to those produced by the pedals on an acoustic piano.

Damper (Right) Pedal

The damper pedal functions in the same way as a damper pedal on an acoustic piano. When the damper pedal is pressed, notes sustain longer. Releasing the pedal immediately stops (damps) any sustained notes. A “half-pedal” effect lets you use the damper pedal to create partial sustain effects, depending on how far down you press the pedal.

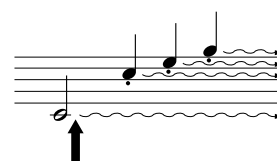
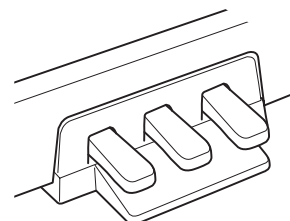

When you press the damper pedal here, the notes you play before you release the pedal have a longer sustain.

Sostenuto (Center) Pedal

If you play a note or chord on the keyboard and press the sostenuto pedal while the note(s) are held, those notes will sustain as long as you hold the pedal (as if the damper pedal had been pressed) but all subsequently played notes will not be sustained. This makes it possible to sustain a chord, for example, while other notes are played “staccato.”

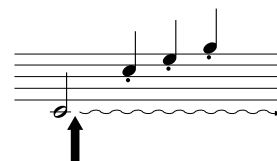

When you press the sostenuto pedal here while holding the note, the note will sustain as long as you hold the pedal.

Soft (Left) Pedal

The soft pedal reduces the volume and slightly changes the timbre of notes played while the pedal is pressed. The soft pedal will not affect notes that are already playing when it is pressed.

Using Headphones

Connect a set of headphones to one of the [PHONES] jacks.

Two [PHONES] jacks are provided.

You can connect two sets of standard stereo headphones. (If you are using only one set of headphones, you can plug them into either jack.)

CAUTION

To protect your hearing, avoid listening with the headphones at a high volume level for long periods of time.

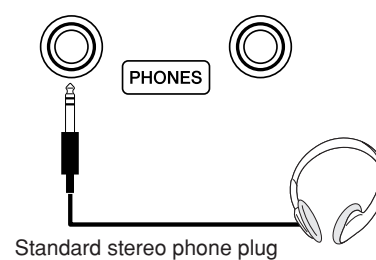

Music Rest

This instrument includes a music rest that can be attached to the instrument by inserting it into the slot at the top of the control panel.

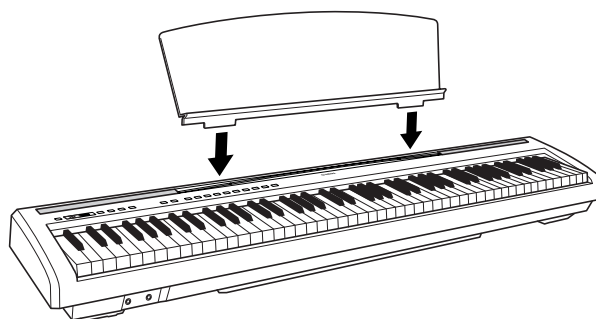

Speakers are built into the instrument at the bottom.

Though you can enjoy playing the instrument even when putting it on a desk or table, we recommend that you use an optional keyboard stand for better sound.

Listening to the Demo Songs

Demo songs are provided that effectively demonstrate each of the voices.

1. While holding down the [DEMO/SONG] button, press one of the voice buttons to listen to the demo songs.

The demo song will start. Demo songs provided for each voice will play back in sequence until you press the [DEMO/SONG] button.

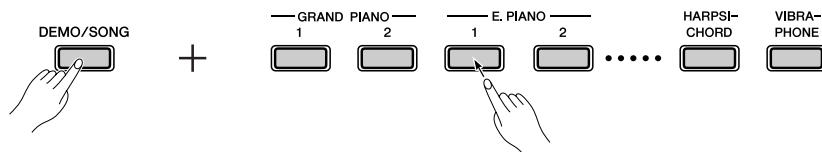

Changing a Demo Song

You can change to another demo song during playback by pressing the **SELECT** [◀]/[▶] button.

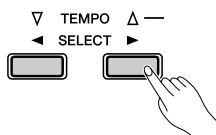

You can also change to another demo song during playback by pressing any one of the voice buttons.

While holding down the [METRONOME] button, use the **TEMPO** [▽]/[Δ] buttons to change the playback tempo.

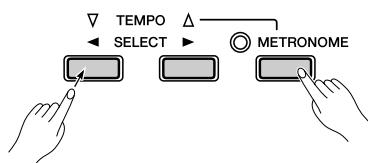

Demo Song List

Voice Name	Title	Composer
PIPE ORGAN	Herr Christ, der ein'ge Gottes-Sohn, BWV.601	J.S. Bach
HARPISICHORD	Concerto a cembalo obbligato, 2 violini, viola e continuo No.7, BWV.1058	J.S. Bach

- The demonstration pieces listed above are short rearranged excerpts of the original compositions.
- All other songs are original (© 2010 Yamaha Corporation).

2. Press the [DEMO/SONG] button to stop the voice demo.



Refer to the voice list on page 16 for more information on the characteristics of each preset voice.



Simply by pressing the [DEMO/SONG] button, you can start the GRAND PIANO 1 demo song and the other demo songs provided for each voice will play back in sequence.



The demo songs will not be transmitted via MIDI.

Listening to the Piano Preset Songs

This instrument provides performance data for piano songs as well as voice demo songs, for your listening pleasure.

1. While holding down the [DEMO/SONG] button, press one of the C2–C#6 keys to select a song to play back.

The number of each piano preset song is assigned to the C2–C#6 keys.

The preset songs will play back consecutively in sequence until you press the [DEMO/SONG] button.

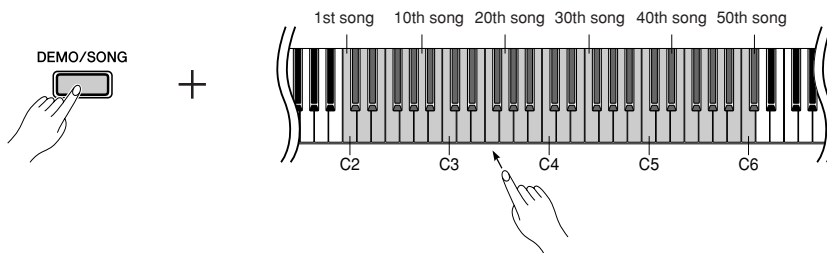

Press the **SELECT** [◀] or [▶] button to change to the next piano song.

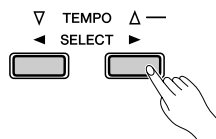

While holding down the [METRONOME] button, use the **TEMPO** [▽]/[△] buttons to change the playback tempo.

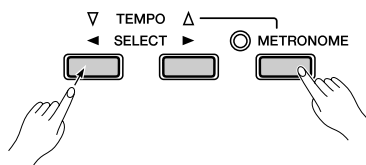

2. Press the [DEMO/SONG] button to stop playback.



To continue playing other songs, see step 1 above.

TERMINOLOGY

Song:

In this manual, performance data is called a "Song." This includes demonstration tunes and piano preset tunes.

Preset:

Preset Data supplied with the internal memory of the P-95 shipped from the factory.



The Preset Song List appears on page 30.



Refer to the Quick Operation Guide on page 32 for details on key assignments.



You can play the keyboard along with the preset song. You can change the voice playing on the keyboard.



When you select a different song (or a different song is selected during chained playback), an appropriate reverb type will be selected accordingly.



The piano preset songs are not transmitted via MIDI.

Using the Metronome

This instrument features a built-in metronome (a device that keeps an accurate tempo) that is convenient for practicing.

1. Press the [METRONOME] button to turn on the metronome.

Start the metronome.

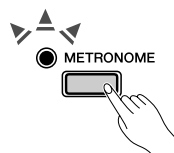

2. Press the [METRONOME] button to stop the Metronome.



Setting the Time Signature

While holding down the [METRONOME] button, press one of the A0–D1 keys.

The first beat is accented with a bell sound and the rest with clicks. Default set is 0/4 (A0). In this setting, clicks sound in all beats.

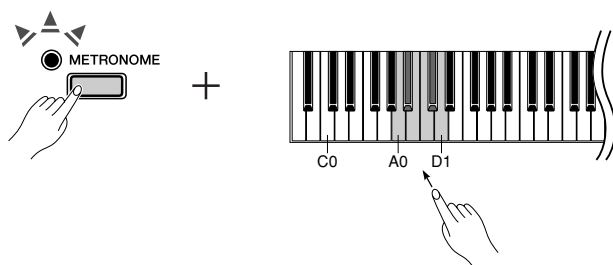

The time signature can also be changed by the following operation.

While holding down the [METRONOME] button, press one of the voice buttons (GRAND PIANO 1–PIPE ORGAN).

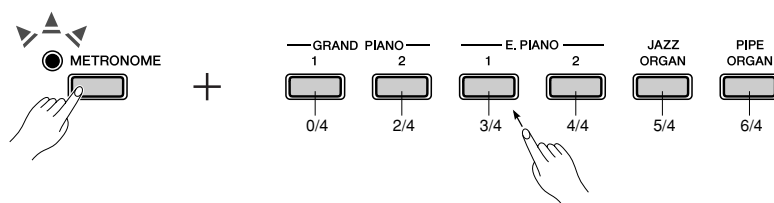

Key	Time signature
A0	0/4
A#0	2/4
B0	3/4
C1	4/4
C#1	5/4
D1	6/4

TERMINOLOGY

Default setting:

The "Default setting" refers to the factory setting obtained when you first turn on the power to the P-95.

Adjusting the Tempo

The tempo of the metronome can be set from 32 to 280 beats per minute.

A number is assigned to each of the following keys.

While holding down the [METRONOME] button, press a sequence of F3–D4 keys to specify a three-digit number.



Default setting (Metronome):
120

Select a number starting from the left-most digit. For example, to set the tempo “95,” press the F3 (0), D4 (9) and A#3 (5) keys in sequence.

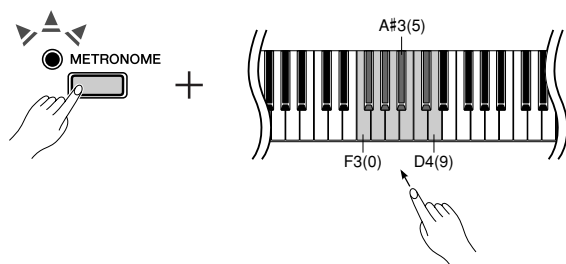

Increasing the tempo value in steps of one:

While holding down the [METRONOME] button, press the F#4 key.

Decreasing the tempo value in steps of one:

While holding down the [METRONOME] button, press the E4 key.

Increasing the tempo value in steps of ten:

While holding down the [METRONOME] button, press the G4 key.

Decreasing the tempo value in steps of ten:

While holding down the [METRONOME] button, press the D#4 key.

Resetting the tempo to default:

While holding down the [METRONOME] button, press the F4 key.

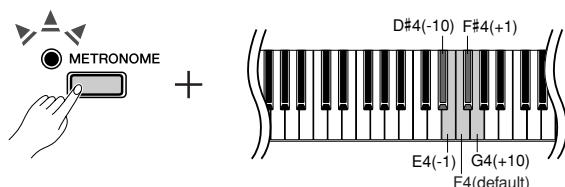

The tempo value can also be changed by the following operation.

While holding down the [METRONOME] button, use the TEMPO [▽]/[△] button to increase or decrease in single steps.

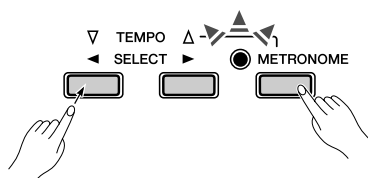

While holding down the [METRONOME] button, press both TEMPO [▽]/[△] buttons simultaneously to restore the default tempo.

Adjusting the Volume

You can change the volume of the metronome sound.

While holding down the [METRONOME] button, press one of the A-1–F#0 keys to determine the volume.

Pressing a higher key in the key range results in a higher volume, while pressing a lower key results in lower volume.

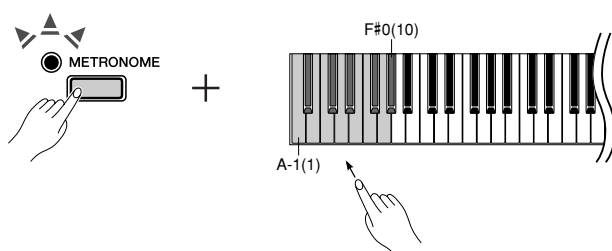

Metronome volume range:

A-1 (1)–F#0 (10)

Default setting: D#0 (7)

Selecting & Playing Voices

Selecting Voices

1. Press one of the voice buttons.

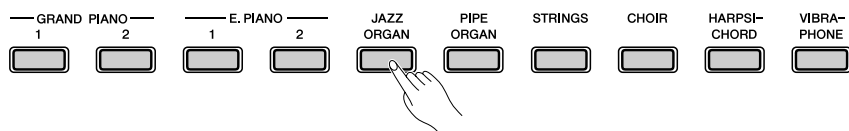

Voice Name	Description
GRAND PIANO 1	Recorded samples from a full concert grand piano. Perfect for classical compositions as well as any other style that requires acoustic piano.
GRAND PIANO 2	Clear piano with bright reverb. Good for popular music.
E. PIANO 1	An electronic piano sound created by FM synthesis. Good for popular music.
E. PIANO 2	The sound of an electric piano using hammer-struck metallic "tines." Soft tone when played lightly, and an aggressive tone when played hard.
JAZZ ORGAN	The sound of a tonewheel type electric organ. Often heard in jazz and rock idioms.
PIPE ORGAN	This is a typical pipe organ sound (8 feet + 4 feet + 2 feet). Good for sacred music from the Baroque period.
STRINGS	Spacious and large-scale string ensemble. Try combining this voice with piano in DUAL.
CHOIR	A big, spacious choir voice. Perfect for creating rich harmonies in slow pieces.
HARPSICHORD	The definitive instrument for baroque music. Since the strings of a harpsichord are plucked, there is no touch response.
VIBRAPHONE	The sound of a vibraphone played with relatively soft mallets.



To familiarize yourself with the characteristics of the voices, listen to the demo songs for each voice (page 12).

TERMINOLOGY

Voice:

In this manual, the term "voice" means "instrument sound."



When you select a voice, an appropriate reverb type will be selected automatically (page 18).

2. Adjust the volume.

Re-adjust the [MASTER VOLUME] slider (page 9) for the most comfortable listening level during your performance.

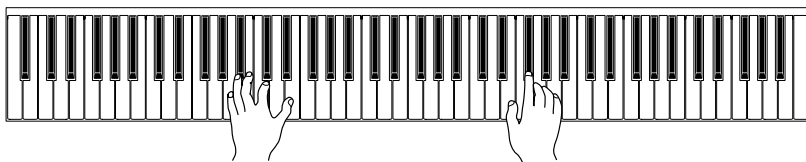

Combining Voices (Dual)

You can play voices simultaneously across the entire range of the keyboard. In this way, you can combine similar voices to create a thicker sound.

1. Press two voice buttons simultaneously to engage Dual.

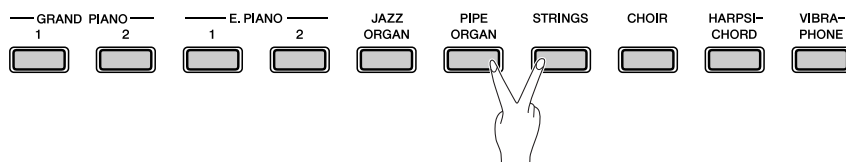

According to the voice button position on the panel, the voice on the left will be designated as Voice 1, and the other will be designated as Voice 2.

You can make the following settings for Voices 1 and 2 in Dual:

Setting the Octave

You can shift the pitch up and down in octave steps for Voice 1 and Voice 2 independently. Depending on which voices you combine in Dual, the combination may sound better if one of the voices is shifted up or down an octave.

While holding down the [METRONOME] button, press one of the A4–D5 keys.

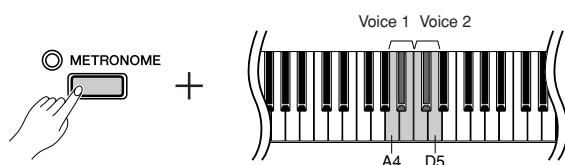

Voice 1	A4	-1	Voice 2	C5	-1
	A#4	0		C#5	0
	B4	+1		D5	+1

Setting the Balance

You can adjust the volume balance between two voices. For example, you can set one voice as the main voice with a louder setting, and make the other voice softer. While holding down the [METRONOME] button, press one of the F#5–F#6 keys. A setting of “0” produces an equal balance between the two Dual voices. Settings below “0” increase the volume of Voice 2 in relation to Voice 1, and settings above “0” increase the volume of Voice 1 in relation to Voice 2.

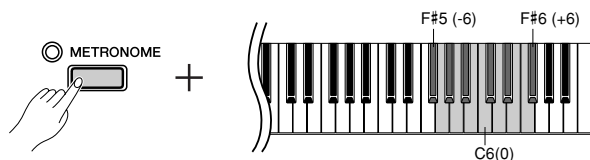

2. Press one of the voice buttons to exit Dual and return to the normal single-voice play.



Reverb in Dual

The reverb type assigned to Voice 1 will take priority. If the reverb assigned to Voice 1 is set to OFF, the reverb assigned to Voice 2 will be in effect.

Adding Variations to the Sound – Reverb

This control enables you to select four different types of reverb effect that add extra depth and expression to the sound to create a realistic acoustic ambience.

Key	Reverb Type	Description
G#6	Room	This setting adds a continuous reverb effect to the sound, similar to the acoustic reverberation you would hear in a room.
A6	Hall1	For a “bigger” reverb sound, use the HALL 1 setting. This effect simulates the natural reverberation of a small-size concert hall.
A#6	Hall2	For a truly spacious reverb sound, use the HALL 2 setting. This effect simulates the natural reverberation of a large concert hall.
B6	Stage	Simulates the reverb of a stage environment.
C7	Off	No effect is applied.

Selecting a Reverb Type

While holding down the [METRONOME] button, press one of the G#6–C7 keys to select a reverb type.

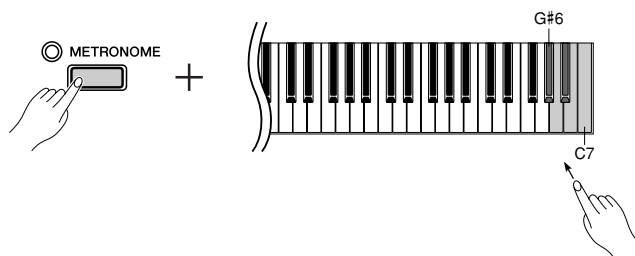

Adjusting Reverb Depth

While holding down the [METRONOME] button, press one of the F1–C#3 keys to adjust the reverb depth for the selected voice.

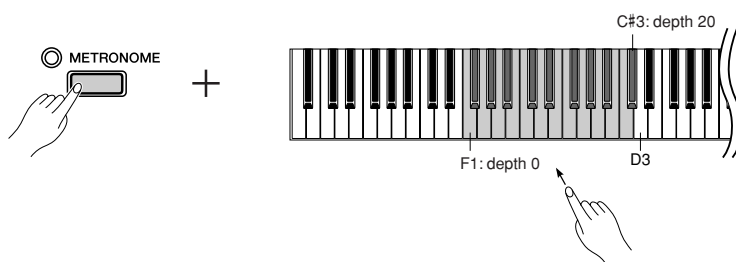

The depth value increases as you press higher keys.

While holding down the [METRONOME] button, press the D3 key to set the reverb to the depth most suitable for the selected voice.



Reverb depth range:
0 (no effect)–
20 (maximum depth)



The default reverb type (including OFF) and depth settings are different for each voice.

Transposition

The Transpose function makes it possible to shift the pitch of the entire keyboard up or down in semitone intervals to facilitate playing in difficult key signatures, and to let you easily match the pitch of the keyboard to the range of a singer or other instruments. For example, if you set the transposition amount to “+5,” playing key C produces pitch F. In this way, you can play a song as though it were in C major, and the P-95 will transpose it to the key of F.

Setting the amount of transposition

While holding down the [DEMO/SONG] and [METRONOME] buttons, press one of the F#2–F#3 keys to set the desired amount of transposition.

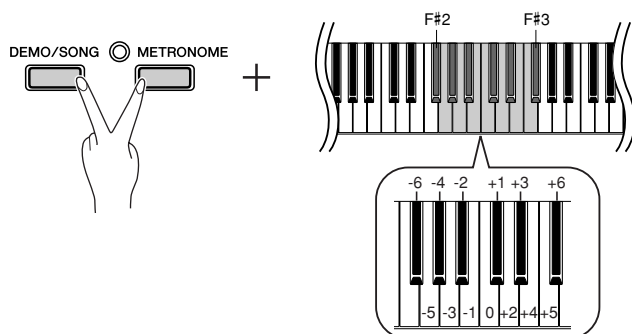

To transpose the pitch down (in semitone steps)

While holding down the [DEMO/SONG] and [METRONOME] buttons, press any key between F#2 and B2.

To transpose the pitch up (in semitone steps)

While holding down the [DEMO/SONG] and [METRONOME] buttons, press any key between C#3 and F#3.

To restore the normal pitch

While holding down the [DEMO/SONG] and [METRONOME] buttons, press the C3 key.

TERMINOLOGY

Transpose:

Changing the key signature. On the P-95, transposing shifts the pitch of the entire keyboard.



Transposition range:

F#2 (-6 semitones)–
C3 (normal pitch)–
F#3 (+6 semitones)

Fine tuning of the Pitch

You can fine tune the pitch of the entire instrument. This function is useful when you play this instrument along with other instruments or CD music.

Setting the Pitch

To raise the pitch

in about 1 cent steps (100 cents = 1 semitone):

Hold down the A-1, B-1 and C0 keys simultaneously and press any key between C3 and B3.

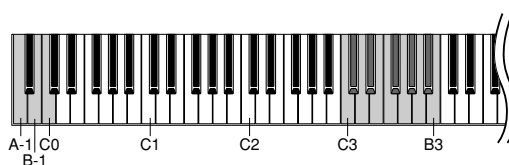

To lower the pitch

in about 1 cent steps (100 cents = 1 semitone):

Hold down the A-1, B-1 and C#0 keys simultaneously and press any key between C3 and B3.

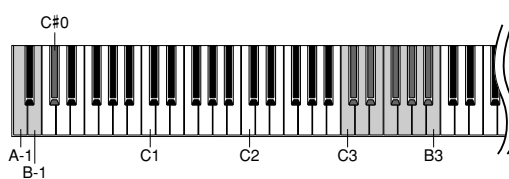

To restore standard pitch:

Hold down the A-1, B-1, C0 and C#0 keys simultaneously and press any key between C3 and B3.

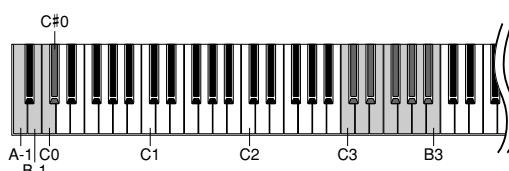

Setting range: -65–+65 cents

The default setting (0 cent) is A3=440Hz. In the 440Hz region, 1Hz=approximately 4 cents. Pressing the key 8 times for example, will set A3 at approximately 442Hz.

Touch Sensitivity

You can adjust the volume level that changes depending on how fast or strong you hit the keys. The following four settings are available.

Key	Touch Sensitivity	Description
A6	Fixed	All notes are produced at the same volume no matter how hard the keyboard is played.
A#6	Soft	Allows maximum loudness to be produced with relatively light key pressure.
B6	Medium	Produces a fairly “standard” keyboard response.
C7	Hard	Requires that the keys be played quite hard to produce maximum loudness.

Setting the Touch Sensitivity Type

While holding down the [DEMO/SONG] button and the [METRONOME] button, press one of the A6–C7 keys to select the desired touch sensitivity.

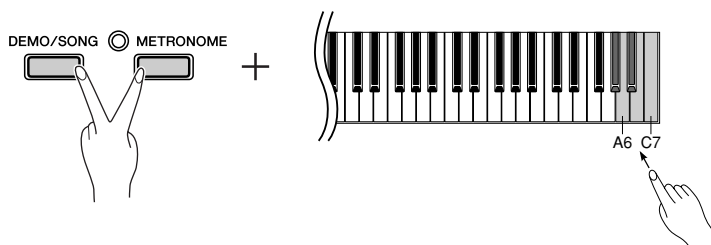

The touch sensitivity settings may have little or no effect with JAZZ ORGAN, PIPE ORGAN and HARPSICHORD voices that are not normally responsive to keyboard dynamics.

Default setting: B6 (Medium)

Recording Your Performance

This instrument's recording function enables you to record your performance of one song.

Recording a performance

1. Make all the initial settings.

Before you begin to record, select the voice you want to record (or voices if you will be using Dual mode). Make any other desired settings (reverb, tempo, etc.) as well. You might also want to set the volume.

You can also adjust the playback volume using the [MASTER VOLUME] slider.

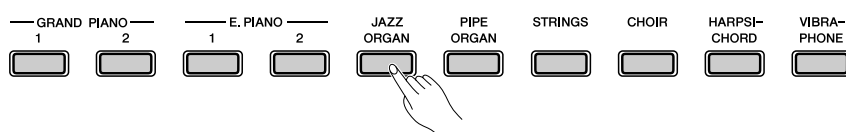

2. Press the [REC] button to engage Record Ready mode.

The [REC] lamp will flash.

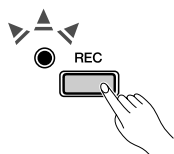

You can turn on the metronome in this step, and adjust the tempo by using the TEMPO [▽]/[△] buttons. (Range: 32–280)

Record Ready mode can be disengaged before recording by pressing the [REC] button again.

3. Start recording.

Recording will begin automatically as soon as you play a note on the keyboard or press the [PLAY] button.

The [REC] lamp will light, and the [PLAY] lamp flashes at the current tempo while recording.

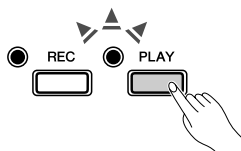

When the instrument is playing back a demo song or preset song, Record mode cannot be engaged.



Recording capacity

This instrument can record up to 65KB (approximately 11,000 notes).



If the metronome was on when you started recording, you'll be able to keep time with the metronome while recording, but the metronome sound will not be recorded.



For more recording information, see page 22.

4. Press either [REC] or [PLAY] button to stop recording.

When recording is stopped, the [REC] lamp and the [PLAY] lamp flash to indicate that the recorded data is being saved to the instrument automatically. After the data is saved, the [REC] lamp will turn off and the [PLAY] lamp will light.

NOTICE

Do not turn off the power of the instrument when the lamps are flashing. Doing so may prevent saving of the song data which you have recorded.

The user song recorder records the following data:

Data in addition to the notes and voices you play is recorded.

- Notes played
- Voice selection
- Pedal (Sustain/Soft/Sostenuto)
- Reverb depth
- Dual mode voices
- Dual balance
- Dual octave shift
- Tempo
- Reverb type (including OFF)



Both the [REC] lamp and the [PLAY] lamp will begin to flash when the recorder memory is almost full. If the memory becomes full, recording will stop automatically. (All recorded data up to that point will be retained.)



You can save the recorded data to a computer. You can also load the recorded data back from a computer and play it back on this instrument (page 25).

Play back the recorded performance

Press the [PLAY] button to play back the recorded performance. To stop playback in the middle of a song, press the [PLAY] button again.

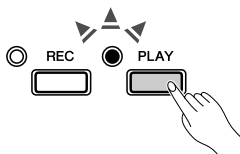

While holding down the [METRONOME] button, use the TEMPO [▽]/[△] buttons to change the playback tempo.

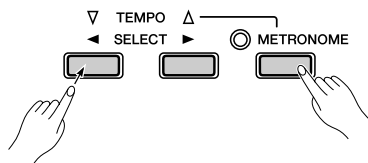

Pressing the [REC] button to start recording, then pressing the [PLAY] button to stop recording will erase all previously- recorded data.



You cannot re-record in the middle of a song.

Changing the Settings of the Recorded Data

The settings of the recorded data can be changed after the recording.

For example, after recording, you can change the voice to create a different ambience or adjust the song tempo to your taste.

You can change the following settings.

- Voice selection
- Dual mode voices
- Sustain/soft pedal depth
- Tempo

1. Press the [REC] button to engage Record Ready mode.

The [REC] lamp will flash.

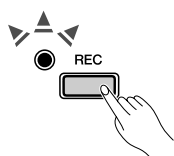

2. Change the settings via the panel controls.

For example, if you wish to change the recorded voice from [E.PIANO 1] to [E.PIANO 2], press the [E.PIANO 2] button. When you wish to change the damper/soft pedal depth, press and hold the pedal.

Be careful not to press the [PLAY] button or a key on the keyboard, either of which will start recording and erase all previously-recorded data on the selected part.

3. Press the [REC] button to exit Record mode.

Be careful not to press the [PLAY] button or a key on the keyboard, either of which will start recording and erase all previously-recorded data.

Connecting MIDI Instruments

This instrument features MIDI IN/OUT terminals, allowing you to connect the P-95 to other instruments and devices—including computers—and take advantage of the various performance and recording capabilities in MIDI applications.

About MIDI

MIDI (Musical Instrument Digital Interface) is a standard format for data transmission/reception. It enables the transfer of performance data and commands between MIDI devices and personal computers. Using MIDI, you can control a connected MIDI device from the P-95, or control the P-95 from a connected MIDI device or computer.

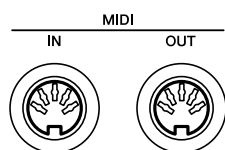

MIDI [IN]: Receives MIDI data.
MIDI [OUT]: Transmits MIDI data.

CAUTION

Before connecting the instrument to other electronic components, turn off the power of all the components.

● Transferring performance data to and from another MIDI device

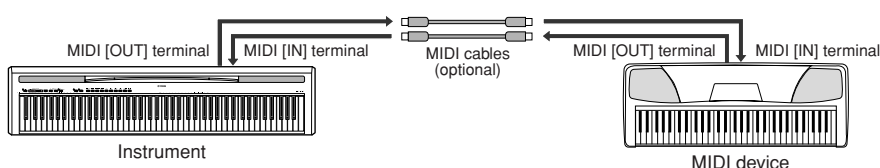

● Transferring MIDI data to and from a computer

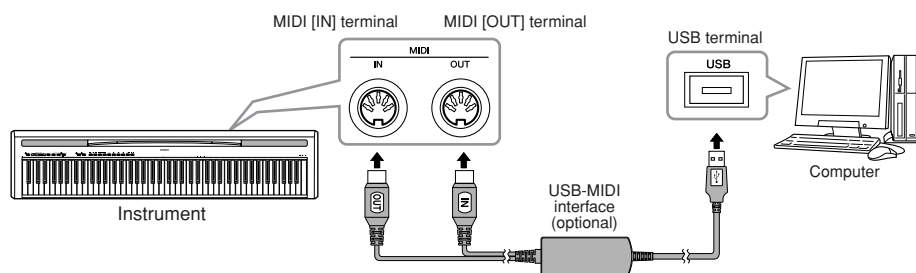

NOTE

Since MIDI data that can be transmitted or received varies depending on the type of MIDI device, check the "MIDI Implementation Chart" to find out what MIDI data and commands your devices can transmit or receive. The MIDI Implementation Chart is included in the Data List, which can be found at the Yamaha website (See page 7).

NOTE

You cannot transmit the voice demo songs and the piano preset songs from the P-95 to another MIDI device.

For MIDI connections, use a standard (optional) MIDI cable, available at most musical instrument stores.

Connecting a Personal Computer

By connecting a computer to the MIDI terminals, you can transfer data between the P-95 and the computer via MIDI.

CAUTION

When connecting the P-95 to a computer, first turn off the power to both the P-95 and the computer before connecting any cables. After making connections, turn on the power to the computer first, then to the P-95.

Connecting the USB port on the computer to the P-95 via an optional USB-MIDI interface

Use a USB-MIDI interface device to connect the USB port on your computer to the P-95's MIDI terminals. You must install the USB-MIDI interface (such as the UX16) driver. For more information, refer to the user's manual that came with the USB-MIDI interface device.

NOTE

When the P-95 is used as a tone module, performance data with voices that are not found on the P-95 will not be played correctly.

Transferring Backup Data between the Computer and the Instrument

You can save backup data of this instrument, such as recorded songs, etc., to a computer, as well as load the saved data back to the instrument from the computer.

Backup Data

The following data will be stored in flash memory on this instrument. This data will be kept after you turn off the power to the instrument.

- Metronome volume
- Metronome tempo
- Touch sensitivity
- Tuning
- Recorded performance data

To transfer the backup data, you must first download Musicsoft Downloader (free software) from Yamaha website at the following URL, and install it on your computer.

<http://music.yamaha.com/download/>

Please visit the URL above to get the information on the computer system requirement for Musicsoft Downloader.

For more information on transferring data, please refer to “Transferring Data Between the Computer and Instrument (for unprotected data)” in the Help file that came with Musicsoft Downloader.

NOTICE

Do not turn off the power to this instrument or unplug the instrument during data transmission. Otherwise, the data being transmitted will not be saved. Furthermore, flash memory operation may become unstable, causing the entire memory to be erased when you turn the power to the instrument on or off.

NOTICE

Do not rename the backup file on the computer. If you do so, it will not be recognized when transferred to the instrument.



The backup data file is automatically named “P-95.BUP”.



Keep in mind that the [REC] and [PLAY] indicators are lit when Musicsoft Downloader is being used.



Before you use this instrument, close the Musicsoft Downloader window and quit the application.

Initializing the Settings

When you initialize the settings, all backup data stored to this instrument will be initialized and reset to the factory default settings.

Turn off the power to the instrument. Then, simultaneously hold down the C7 key (right-most key on the keyboard) and turn the power on again.

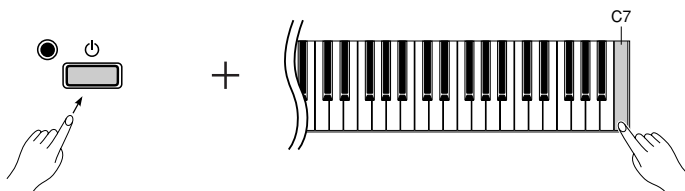

NOTICE

Do not turn off the power to this instrument while it is initializing the data in its internal memory (that is, while the [REC] and [PLAY] button indicators are flashing).



If this instrument somehow becomes disabled or malfunctions, turn off the power to the instrument, then perform the initialization procedure.

MIDI Functions

You can make detailed adjustments to MIDI settings.

MIDI Transmit/Receive Channel Selection

In any MIDI control setup, the MIDI channels of the transmitting and receiving devices must be matched for proper data transfer.

This parameter enables you to specify the channel on which the P-95 transmits or receives MIDI data.

Setting the Transmit Channel

While holding down the [DEMO/SONG] and [METRONOME] buttons, press one of the C1–E2 keys.

Setting the Receive Channel

While holding down the [DEMO/SONG] and [METRONOME] buttons, press one of the C4–F5 keys.

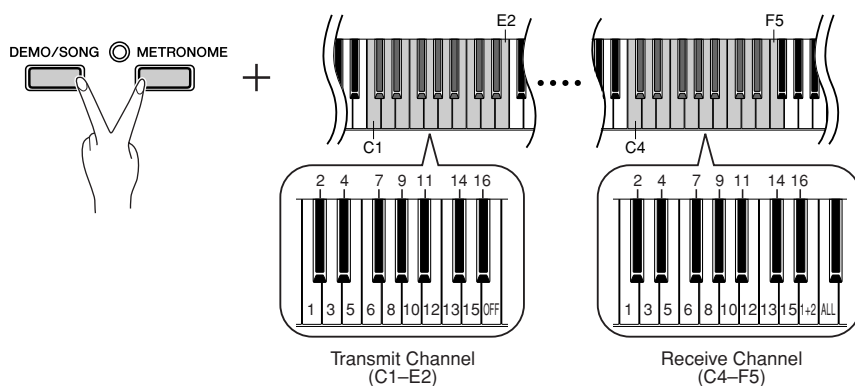

In Dual, Voice 1 data is transmitted on its specified channel and Voice 2 data is transmitted on the next greater channel number relative to the specified channel. In this case, no data is transmitted if the transmit channel is set to "OFF."

ALL:

"Multi-timbre" Receive. This allows simultaneous reception of different parts on all 16 MIDI channels, enabling the P-95 to play multi-channel song data received from a music computer or sequencer.

1+2:

"1+2" Receive. This allows simultaneous reception on channels 1 and 2 only, enabling the P-95 to play 1 and 2 channel song data received from a music computer or sequencer.

Program change and other like channel messages received will not affect the P-95's panel settings or the notes you play on the keyboard.

Data for the demo song and piano preset songs cannot be transmitted via MIDI.

Local Control ON/OFF

"Local Control" refers to the fact that, normally, the P-95 keyboard controls its internal tone generator, allowing the internal voices to be played directly from the keyboard. This situation is "Local Control On," since the internal tone generator is controlled locally by its own keyboard.

Local control can be turned OFF, however, so that the P-95 keyboard does not play the internal voices, but the appropriate MIDI information is still transmitted via the MIDI OUT terminal when notes are played on the keyboard. At the same time, the internal tone generator responds to MIDI information received via the MIDI IN terminal.

While holding down the [DEMO/SONG] and [METRONOME] buttons, press the C6 key. Pressing the C6 key repeatedly toggles between Local Control On and Off.

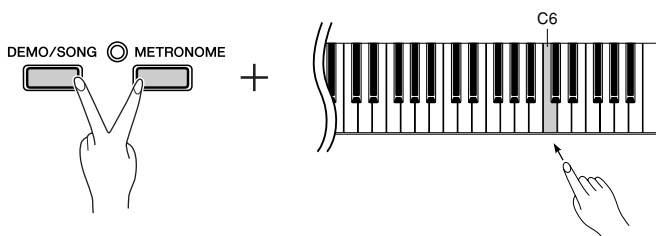

Default setting: ON

Program Change ON/OFF

Normally the P-95 will respond to MIDI program change numbers received from an external keyboard or other MIDI device, causing the same numbered voice to be selected on the corresponding channel (the keyboard voice does not change). The P-95 will normally also send a MIDI program change number whenever one of its voices is selected, causing the same numbered voice or program to be selected on the external MIDI device if the device is set up to receive and respond to MIDI program change numbers. This function makes it possible to cancel program change number reception and transmission so that voices can be selected on the P-95 without affecting the external MIDI device.

While holding down the [DEMO/SONG] and [METRONOME] buttons, press the C#6 key. Pressing the C#6 key repeatedly toggles between Program Change On and Off.

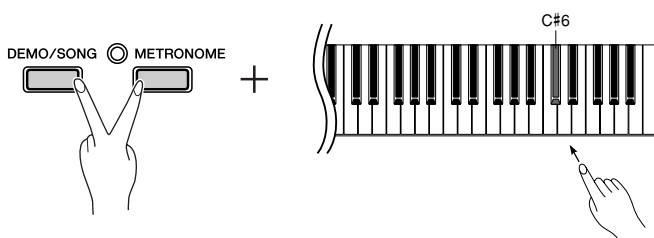

Default setting: ON



For information on program change numbers for each voice, check the MIDI Data Format on the web (please refer to "Data List" on page 7).

Control Change ON/OFF

Normally the P-95 will respond to MIDI control change data received from an external MIDI device or keyboard, causing the voice on the corresponding channel to be affected by pedal and other "control" settings received from the controlling device (the keyboard voice is not affected). The P-95 also transmits MIDI control change information when the pedal or other appropriate controls are operated.

This function makes it possible to cancel control change data reception and transmission so that, for example, the P-95's pedal and other controls can be operated without affecting an external MIDI device.

While holding down the [DEMO/SONG] and [METRONOME] buttons, press the D6 key. Pressing the D6 key repeatedly toggles between Control Change On and Off.

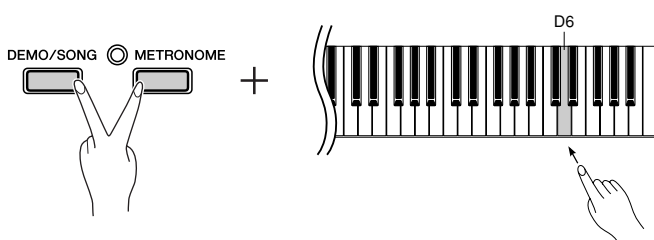

For information on control changes that can be used with the P-95, refer to the MIDI Data Format section in the Data List, which can be found at the Yamaha website (See page 7).

Default setting: ON

Troubleshooting

Problem	Possible Cause and Solution
The instrument does not turn on.	The instrument has not been plugged in properly. Securely insert the female plug into the jack on the instrument, and the male plug into a proper AC outlet (page 9).
Noise is heard from the speakers or headphones.	The noise may be due to interference caused by the use of a mobile phone in close proximity to the instrument. Turn off the mobile phone, or use it further away from the instrument.
The overall volume is low, or no sound is heard.	The Master Volume is set too low; set it to an appropriate level using the [MASTER VOLUME] control (page 9).
	Make sure a pair of headphones is not connected to the headphones jack (page 11).
	Make sure that Local Control (page 26) is ON.
The pedal has no effect.	The pedal cable/plug may not be properly connected. Make sure to securely insert the pedal plug into the SUSTAIN/PEDAL UNIT jack (page 10).
The footswitch (for sustain) seems to produce the opposite effect. For example, pressing the footswitch cuts off the sound and releasing it sustains the sounds.	The polarity of the footswitch is reversed because the footswitch was pressed when the power was turned on. Turn off the power and turn it again to reset the function. Make sure to not press the footswitch when turning the power on.

Optional Equipment

Foot Pedal (FC3)

Footswitch (FC4)

Keyboard Stand (L-85/L-85S)

Pedal Unit (LP-5A)

USB-MIDI interface (UX16)

Headphones (HPE-150/HPE-30)

AC Power Adaptor (PA-5D/PA-150 or an equivalent)

Preset Song List / Liste des morceaux prédéfinis / Liste der voreingestellten Songs / Lista de canciones preseleccionadas / Список встроенных мелодий

No.	Title	Composer
1	Invention No. 1	J.S.Bach
2	Invention No. 8	J.S.Bach
3	Gavotte	J.S.Bach
4	Prelude (Wohltemperierte Klavier I No.1)	J.S.Bach
5	Menuett G dur BWV.Anh.114	J.S.Bach
6	Le Coucou	L-C.Daquin
7	Piano Sonate No.15 K.545 1st mov.	W.A.Mozart
8	Turkish March	W.A.Mozart
9	Menuett G dur	W.A.Mozart
10	Little Serenade	J.Haydn
11	Perpetuum mobile	C.M.v.Weber
12	Ecossaise	L.v.Beethoven
13	Für Elise	L.v.Beethoven
14	Marcia alla Turca	L.v.Beethoven
15	Piano Sonate op.13 "Pathétique" 2nd mov.	L.v.Beethoven
16	Piano Sonate op.27-2 "Mondschein" 1st mov.	L.v.Beethoven
17	Piano Sonate op.49-2 1st mov.	L.v.Beethoven
18	Impromptu op.90-2	F.P.Schubert
19	Moments Musicaux op.94-3	F.P.Schubert
20	Frühlingslied op.62-2	J.L.F.Mendelssohn
21	Jägerlied op.19b-3	J.L.F.Mendelssohn
22	Fantaisie-Impromptu	F.F.Chopin
23	Prelude op.28-15 "Raindrop"	F.F.Chopin
24	Etude op.10-5 "Black keys"	F.F.Chopin
25	Etude op.10-3 "Chanson de l'adieu"	F.F.Chopin
26	Etude op.10-12 "Revolutionary"	F.F.Chopin
27	Valse op.64-1 "Petit chien"	F.F.Chopin
28	Valse op.64-2	F.F.Chopin
29	Valse op.69-1 "L'adieu"	F.F.Chopin
30	Nocturne op.9-2	F.F.Chopin
31	Träumerei	R.Schumann
32	Fröhlicher Landmann	R.Schumann
33	La prière d'une Vierge	T.Badarzewska
34	Dolly's Dreaming and Awakening	T.Oesten
35	Arabesque	J.F.Burgmüller
36	Pastorale	J.F.Burgmüller
37	La chevaleresque	J.F.Burgmüller
38	Liebesträume Nr.3	F.Liszt
39	Blumenlied	G.Lange
40	Barcarolle	P.I.Tchaikovsky
41	Melody in F	A.Rubinstein
42	Humoresque	A.Dvořák
43	Tango (España)	I.Albéniz
44	The Entertainer	S.Joplin
45	Maple Leaf Rag	S.Joplin
46	La Fille aux Cheveux de Lin	C.A.Debussy
47	Arabesque 1	C.A.Debussy
48	Clair de lune	C.A.Debussy
49	Rêverie	C.A.Debussy
50	Cakewalk	C.A.Debussy

Specifications / Caractéristiques techniques / Technische Daten / Especificaciones / Технические характеристики

Size/Weight	Dimensions	Width	1,326mm (52-3/16")	
		Height	151.5mm (5-15/16")	
		Depth	295mm (11-5/8")	
	Weight		12.0kg (26 lbs., 7 oz.)	
Control Interface	Keyboard	Number of Keys	88	
		Type	Graded Hammer Standard (GHS) Keyboard	
		Touch Sensitivity	Hard/Medium/Soft/Fixed	
	Panel	Language	English	
Voices	Tone Generation	Tone Generating Technology	AWM Stereo Sampling	
	Polyphony	Number of Polyphony (Max.)	64	
	Preset	Number of Voices	10	
Effects	Types	Reverb	Yes	
	Functions	Dual	Yes	
Songs	Preset/Demo	Number of Preset Songs	50	
		Recording	Number of Songs	1
			Number of Tracks	1
			Data Capacity	65KB (ca. 11,000 notes)
			Recording Function	Yes
	Data Format	Playback	Original Format	
Recording		Original Format		
Functions	Overall Controls	Metronome	Yes	
		Tempo Range	32–280	
		Transpose	-6 to 0, 0 to +6	
		Tuning	Yes	
Storage and Connectivity	Connectivity	DC IN	12V	
		Headphones	x 2	
		Sustain Pedal*	Yes	
		Pedal Unit*	Yes	
		MIDI	IN/OUT	
Amplifiers and Speakers	Amplifiers		6W x 2	
	Speakers		(12cm x 6cm) x 2	
Power Supply	Power Supply		AC Power Adaptor PA-150 or an equivalent recommended by Yamaha	
Included Accessories			Owner's Manual, AC Power Adaptor, Footswitch, Music Rest, My Yamaha Product User Registration	

- When an optional FC3 Foot Pedal or an optional LP-5A Pedal Unit is connected, the half pedal effect can be used.
- Wenn ein optionales Fußpedal FC3 oder eine optionale Pedaleinheit LP-5A angeschlossen wird, kann der Halbpedal-Effekt verwendet werden.
- Lorsqu'une pédale au pied FC3 ou un pédalier LP-5A fournis en option sont connectés, il est possible d'utiliser l'effet de pédale à mi-course.
- Si se conecta un pedal FC3 o una unidad de pedal LP-5A opcionales, se puede utilizar el efecto de medio pedal.
- Если подключена дополнительная ножная педаль FC3 или дополнительный блок педалей LP-5, можно использовать эффект полупедали.
- Specifications and descriptions in this owner's manual are for information purposes only. Yamaha Corp. reserves the right to change or modify products or specifications at any time without prior notice. Since specifications, equipment or options may not be the same in every locale, please check with your Yamaha dealer.
- Les caractéristiques techniques et les descriptions du mode d'emploi ne sont données que pour information. Yamaha Corp. se réserve le droit de changer ou modifier les produits et leurs caractéristiques techniques à tout moment sans aucun avis. Du fait que les caractéristiques techniques, les équipements et les options peuvent différer d'un pays à l'autre, adressez-vous au distributeur Yamaha le plus proche.
- Die technischen Daten und Beschreibungen in dieser Bedienungsanleitung dienen nur der Information. Yamaha Corp. behält sich das Recht vor, Produkte oder deren technische Daten jederzeit ohne vorherige Ankündigung zu verändern oder zu modifizieren. Da die technischen Daten, das Gerät selbst oder Sonderzubehör nicht in jedem Land gleich sind, setzen Sie sich im Zweifel bitte mit Ihrem Yamaha-Händler in Verbindung.
- Las especificaciones y descripciones de este manual del propietario tienen sólo el propósito de servir como información. Yamaha Corp. se reserva el derecho a efectuar cambios o modificaciones en los productos o especificaciones en cualquier momento sin previo aviso. Puesto que las especificaciones, equipos u opciones pueden no ser las mismas en todos los mercados, solicite información a su distribuidor Yamaha.
- Технические характеристики и их описания в данном руководстве пользователя предназначены только для общего сведения. Корпорация Yamaha сохраняет за собой право модифицировать свои изделия и менять их технические характеристики без предварительного уведомления. Поскольку технические характеристики, оборудование и набор возможностей могут зависеть от региона, обращайтесь за информацией к местному представителю корпорации Yamaha.

Quick Operation Guide

While holding down the [DEMO/SONG] and/or [METRONOME] button, press the highlighted keys shown below to select preset songs or set parameters. (Refer to the diagram 1 / 2 / 3 below.)

1

DEMO/SONG

Preset Song

Song No. 1	Song No. 2
Song No. 3	Song No. 4
Song No. 5	Song No. 6
Song No. 7	Song No. 8
Song No. 9	Song No. 10
Song No. 11	Song No. 12
Song No. 13	Song No. 14
Song No. 15	Song No. 16
Song No. 17	Song No. 18
Song No. 19	Song No. 20
Song No. 21	Song No. 22
Song No. 23	Song No. 24
Song No. 25	Song No. 26
Song No. 27	Song No. 28
Song No. 29	Song No. 30
Song No. 31	Song No. 32
Song No. 33	Song No. 34
Song No. 35	Song No. 36
Song No. 37	Song No. 38
Song No. 39	Song No. 40
Song No. 41	Song No. 42
Song No. 43	Song No. 44
Song No. 45	Song No. 46
Song No. 47	Song No. 48
Song No. 49	Song No. 50

2

METRONOME

Metronome Volume

Metronome Time Signature

Reverb Depth

Metronome Tempo

Dual Octave Setting

Dual Balance

Reverb Type

1	2
3	4
5	6
7	8
9	10
No downbeat	2/4
3/4	5/4
4/4	6/4
6/4	
0	1
2	3
4	5
6	
7	8
9	10
11	12
13	14
15	16
17	18
19	20
Default depth	
Number key 0	Number key 1
Number key 2	Number key 3
Number key 4	Number key 5
Number key 6	Number key 7
Number key 8	Number key 9
10 steps decrease	10 steps increase
One step decrease	One step increase
Default tempo	
-1 (Voice 1)	0 (Voice 1)
+1 (Voice 1)	
-1 (Voice 2)	0 (Voice 2)
+1 (Voice 2)	
-5	-6
-3	-4
-1	-2
0	+1
+2	+3
+4	+5
+6	
0	+1
+2	+3
+4	+5
+6	
Hall 1	Room
Stage	Hall 2
OFF	

3

DEMO/SONG

METRONOME

MIDI Transmit Channel

Transpose

MIDI Receive Channel

Local Control

Program Change

Control Change

Touch Sensitivity

Ch 1	Ch 2
Ch 3	Ch 4
Ch 5	Ch 6
Ch 7	Ch 8
Ch 9	Ch 10
Ch 11	Ch 12
Ch 13	Ch 14
Ch 15	Ch 16
OFF	
-5	-6
-3	-4
-1	-2
0 (Normal pitch)	+1
+2	+3
+4	+5
+6	
Ch 1	Ch 2
Ch 3	Ch 4
Ch 5	Ch 6
Ch 7	Ch 8
Ch 9	Ch 10
Ch 11	Ch 12
Ch 13	Ch 14
Ch 15	Ch 16
1+2	
ALL	
ON/OFF	ON/OFF
ON/OFF	
FIXED	SOFT
MEDIUM	
HARD	

* Refer to page 19 for information on fine tuning of the pitch.

Important Notice: Guarantee Information for customers in European Economic Area (EEA) and Switzerland

English	Important Notice: Guarantee Information for customers in EEA* and Switzerland For detailed guarantee information about this Yamaha product, and Pan-EEA* and Switzerland warranty service, please either visit the website address below (printable file is available at our website) or contact the Yamaha representative office for your country (see overleaf). * EEA: European Economic Area
Deutsch	Wichtig Hinweis: Garantie-Information über dieses Produkt von Yamaha, sowie über den Pan-EEWR- und Schweizer Garantieservice. Besuchen Sie bitte entweder die folgend angegebene Internetadresse (eine druckfähige Version befindet sich auch auf unserer Webseite), oder wenden Sie sich an den für Ihr Land zuständige Yamaha-Vertrieb (siehe Rückseite).
Français	Remarque importante: Informations de garantie pour les clients de l'EEE et la Suisse Pour des informations plus détaillées sur la garantie de ce produit Yamaha et sur le service de garantie applicable dans l'espace de l'EEE ainsi qu'en Suisse, consultez notre site Web à l'adresse ci-dessous (le fichier imprimable est disponible sur notre site Web) ou contactez directement Yamaha dans votre pays de résidence (voir verso). * EEE : Espace Economique Européen
Nederlands	Belangrijke mededeling: Garantie-informatie voor klanten in de EER* en Zwitserland Voor gedetailleerde garantie-informatie over dit Yamaha-product en de garantieservice in heel de EER* en Zwitserland, gaat u naar de onderstaande website (u vindt een afdrukbare bestand op onze website) of neemt u contact op met de vertegenwoordiging van Yamaha in uw land (zie omzeggende). * EER: Europese Economische Ruimte
Español	Aviso importante: Información sobre la garantía para los clientes del EEE* y Suiza Para una información detallada sobre este producto Yamaha y sobre el soporte de garantía en la zona EEE* y Suiza, visite la dirección web que se incluye más abajo (la versión del archivo para imprimir está disponible en nuestro sitio web) o póngase en contacto con el representante de Yamaha en su país (ver al dorso). * EEE: Espacio Económico Europeo
Italiano	Avviso importante: Informazioni sulla garanzia per i clienti residenti nell'EEA* e in Svizzera Per informazioni dettagliate sulla garanzia relativa a questo prodotto Yamaha e l'assistenza in garanzia nella paese EEA* e in Svizzera, potete consultare il sito Web all'indirizzo riportato di seguito (è disponibile il file in formato stampabile) oppure contattate l'ufficio di rappresentanza locale della Yamaha (indirizzi sul retro). * EEA: Area Economica Europea
Português	Aviso importante: Informação sobre as garantias para clientes da AEE* e da Suíça Para obter uma informação detalhada sobre este produto da Yamaha e sobre o serviço de garantia na AEE* e na Suíça, visite o site a seguir (o arquivo para impressão está disponível no nosso site) ou entre em contato com o escritório de representação da Yamaha no seu país (consulte o verso). * AEE: Área Económica Europeia
Ελληνικά	Σημαντική ανακοίνωση: Πληροφορίες για τους πελάτες στον ΕΟΧ* και Ελβετία Για λεπτομερείς πληροφορίες σχετικά με το παρόν προϊόν της Yamaha και την κάλυψη εγγύησης σε όλη τις χώρες του ΕΟΧ* και την Ελβετία, επισκεφτείτε την παρακάτω ιστοσελίδα (Εκτυλιξιμόμο αρχείο PDF είναι διαθέσιμο στην ιστοσελίδα μας ή απευθείας από αντιπροσωπεία της Yamaha στο χώρο σας). (βλ. πίσω μέρος εγχειρίδι). * ΕΟΧ: Ευρωπαϊκός Οικονομικός Χώρος.
Svenska	Viktigt: Garantiformation för kunder i EES-området* och Schweiz För detaljerad information om denna Yamaha-produkt samt garantierbetet i hela EES-området* och Schweiz, kan du antingen besöka nedanstående webbadress (en utskriftsversion till finns på webbplatsen) eller kontakta Yamahas officiella representant i ditt land (se baksidan). * EES: Europeiska Ekonomiska Samarbetsområdet
Norsk	Viktig merknad: Garantiformasjon for kunder i EØS* og Sveits Deiligst garantiinformasjon om dette Yamaha-produktet og garantitjenesten for hele EØS-området* og Sveits kan fås enten ved å besøke nedstående nettside (utskriftsversjon finnes på våre nettsider) eller kontakte lokale Yamaha-kontorer i landet der du bor (se neste side). * EØS: Det europeiske økonomiske samarbeidsområdet
Dansk	Vigtig oplysning: Garantiplysninger til kunder i EØO* og Schweiz De kan finde detaljerede garantiplysninger om dette Yamaha-produkt og den fælles garantitjenestevordning for EØO* (og Schweiz) ved at besøge det websted, der er angivet nedenfor (der findes en fil, som kan udskrives, på vores websted), eller ved at kontakte Yamahas nationale repræsentationskontor i det land, hvor De bor (se næste side). * EØO: Det Europæiske Økonomiske Område

Suomi	Tärkeä ilmoitus: Takuutiedot Euroopan talousalueen (ETA)* ja Sveitsin alueille Tämän Yamaha-tuotteen sekä ETA-alueen ja Sveitsin takuuta koskevat yksityiskohdat tiedot saatte alla olevasta nettosoitteesta. (Tulostettava tiedosto saatavissa sivustollamme.) Voitte myös ottaa yhteyttä paikalliseen Yamaha-edustajaan (lisätietoja kääntänohjeella). *ETA: Euroopan talousalue
Polski	Ważne: Wydaruj gwarancje i warunki w EOG* i Szwajcarii Aby dowiedzieć się więcej na temat warunków gwarancyjnych tego produktu, firm Yamaha i serwisu gwarancyjnego w całym EOG* i Szwajcarii, należy odwiedzić wskazaną poniżej stronę internetową (plik gotowy do wydruku znajduje się na naszej stronie internetowej). Udostępniamy również przystawczelstwem firm Yamaha w swoim kraju (informacje na ten temat znajdują się na odwrocie strony). * EOG — Europejski Obszar Gospodarczy
Cesky	Důležitá zpráva: Zdrutni informace pro zákazníky v EHS* a ve Švýcarsku Podrobné zdrutni informace o tomto produktu Yamaha a zdrutni servisu v celém EHS* a ve Švýcarsku nalezíte na níže uvedené webové adrese (součástí řídku je tiskový nástřik webových stránek) nebo se můžete obrátit na zástupci firmy Yamaha ve své zemi (viz druhá strana). * EHS: Evropský hospodářský prostor
Magyar	Főfontos figyelemzetés: Garancia-információk az EGT* területén és Svájcban élő vásárlók számára A jelen Yamaha termékre vonatkozó részletes garancia-információk, valamint az EGT*-re és Svájcra kiterjedő garanciális szolgálatokról részletesen keressen fel webhelyünket az alábbi címen (a webhelyen nyomtatható fájl is talál). Vagy pedig lépjen kapcsolatba az országában működő Yamaha képviselői:rodával (lásd a következő oldalon). * EGT: Európai Gazdasági Térség
Esti keel	Ouline märkus: Garantiteavne Euroopa Majanduspiirkonna (EMP)* ja Sveitsi klientidele Täpsema teavne saamiseks selle Yamaha toote garantii ning kogu Euroopa Majanduspiirkonna ja Sveitsi garantiteeninduse kohta, külastage palun veebisaiti alljärgneval aadressil (meie saidil on saadaval printida val) või pöörduge meie regioonil Yamaha esinduse poole (lätjalgiste leheküljel). * EMP: Euroopa Majanduspiirkond
Latviešu	Svarīgs paziņojums: garantijas informācija klientiem EEE* un Šveicā Lai saņemtu detaļādu garantijas informāciju par šo Yamaha produktu, kā arī garantijas apkalpošanu EEE* un Šveicā, izdruku, atpērkieteliet zīmēt, norādot tīmekļa vietnes adresi (tīmekļa vietne ir pieejams drukājama faila) vai sazinieties ar Jūsu valsti arhāloģoslo Yamaha pārstāvēniecību (skatiet tālruni lapas). * EEE: Eiropas Ekonomiskās zona
Lietuvių kalba	Dėmesio: Informācija dėl garantijos priekāpams EEE* ir Šveicarijole Jei reikia išsamios informacijos apie šį Yamaha produktą ir jo techninę priežiūrą visose EEE* ir Šveicarijole, apsilankykite mūsų svetainėje (toliau nurodytu adresu (svetainėje yra spausdinamas failas) arba kreipkitės į Yamaha atstovų savą šaliai (žr. kitole puslę). * EEE – Europos ekonominė erdvė
Slovenščina	Dolžite upozornje: Informācie o zārtike prekāzānkov v EHP* a Švāicarsku Podrobne informācie o zārtike ukājate sa obojo produktu od splošnosti Yamaha a garāntijom servise v EHP* a Švāicarsku nāglete na webovej strani uvedenej niže (na naši webovej strani je k dispoziciji slobor na lāto) alebo sa obrāte na zāstūporo splošnosti Yamaha vo svojej krajini (pozri nasledujočo stranu). * EHP: Evropsky hospodārsky prostor
Български език	Важно съобщение: Информация за гаранцията за клиентъ в ЕПГ* и Швейцария За подробна информация за гаранцията за този продукт на Yamaha и гаранционното обслужване в паневропейската зона на ЕПГ* и Швейцария или посетете посочения по-долу уеб сайт (на нашия уеб сайт има файл за печат), или се свържете с представителния офис на Yamaha във вашата страна (жж. на глрба). * ЕПГ: Европейския икономически пространств
Limba română	Notificarea importantă: Informații despre garanție pentru clienții din SEE* și Elveția Pentru informații detaliate privind acest produs Yamaha și servicii de garanție Pan-SEE* și Elveția, vizitați site-ul la adresa de mai jos (fișierul imprimabil este disponibil pe site-ul nostru) sau contactați biroul reprezentanței Yamaha din țara dumneavoastră (a se vedea pe verso). * SEE: Spațiul Economic European

<http://europe.yamaha.com/warranty/>

Yamaha Representative Offices in Europe

AUSTRIA

Yamaha Music Europe GmbH
Branch Austria
Schlegelgasse 20, A-1100 Wien Austria
Tel: +43 (0)1 602 03900
Fax: +43 (0)1 602 039051

BELGIUM

Yamaha Music Europe
Branch Benelux
Clariessenhof 5b NL, 4133 AB, Vianen
The Netherlands
Tel: +31 (0)347 358040
Fax: +31 (0)347 358060

BULGARIA

Yamaha Music Europe GmbH
Branch Austria (Central and Eastern Europe)
Schlegelgasse 20, A-1100 Wien Austria
Tel: +43 (0)1 602 03900
Fax: +43 (0)1 602 039051

CYPRUS

NAKKAS Music Cyprus Ltd.
31C Nikos Ave., 1086 Nicosia
Tel: +357 (0)22 510 477
Fax: +357 (0)22 511 080

CZECH REPUBLIC

Yamaha Music Europe GmbH
Branch Austria (Central and Eastern Europe)
Schlegelgasse 20, A-1100 Wien Austria
Tel: +43 (0)1 602 03900
Fax: +43 (0)1 602 039051

DENMARK

YS Copenhagen Liaison Office
(Yamaha Scandinavia AB Filial Denmark)
Generatørvvej 6A, 2730 Herlev, Denmark
Tel: +45 44 92 49 00
Fax: +45 44 54 47 09

ESTONIA

Yamaha Music Europe GmbH
Sp. z o.o. Oddział w Polsce
(Branch Poland)
ul. 17 Sycznia 56
PL-02-146 Warszawa Poland
Tel: +48 (0)22 500 29 25
Fax: +48 (0)22 500 29 30

FINLAND

(For Musical Instrument)
F - Musiikkioy
Kasalanenkatu 7, PL280
00101 Helsinki, Finland
Tel: +358 (0)9 618511
Fax: +358 (0)9 61851385

(For Pro Audio)

Yamaha Scandinavia AB
J A Wettergrens gata 1
Västtra Frolunda, Sweden
(Box 300 53, 400 43 Göteborg
Sweden - Postal Address)
Tel: +46 (0)31 893400
Fax: +46 (0)31 454026

FRANCE

Yamaha Musique France
Zone d'activité de Pariest
7, rue Ambroise Croizat
77183 Croissy-Beaubourg, France
(B.P. 70, 77312 Marne-la Vallée Cedex 2
France-Adresse postale)
Tel: +33 (0)1 64 61 4000
Fax: +33 (0)1 64 61 4079

GERMANY

Yamaha Music Europe GmbH
Sternenstr. 22-34
D-25462 Rellingen, b. Hamburg, Germany
Tel: +49 (0)4101 3030
Fax: +49 (0)4101 303 77702

GREECE

PH, Nakas S.A.Music Houses/Service
19 KM Leoforos Lavriou
19002 Peania / Attiki, Greece
Tel: +30 (0)210 6686260
Fax: +30 (0)210 6686289

HUNGARY

Yamaha Music Europe GmbH
Branch Austria (Central and Eastern Europe)
Schlegelgasse 20, A-1100 Wien Austria
Tel: +43 (0)1 602 03900
Fax: +43 (0)1 602 039051

ICELAND

(For Musical Instrument)
HLJODFAERHUSSID EHF
Síðunnenu 20
108 Reykjavik, Iceland
Tel: +354 523 50 50
Fax: +354 568 65 14

(For Pro Audio)

Yamaha Scandinavia AB
J A Wettergrens gata 1
Västtra Frolunda, Sweden
(Box 300 53, 400 43 Göteborg
Sweden - Postal Address)
Tel: +46 (0)31 893400
Fax: +46 (0)31 454026

IRELAND (REPUBLIC OF IRELAND)

Yamaha Music UK Ltd.
Sherbourne Drive
Tilbrook, Milton Keynes MK7 9BL
United Kingdom
Tel: +353 (0)1 526 2449
Fax: +44 (0)1908 369278

ITALY

Yamaha Musica Italia s.p.a.
Viale Italia 88
20020, Linate (Milano), Italy
Tel: +39 (0)02 935717
Fax: +39 (0)02 937 0956

LATVIA

Yamaha Music Europe GmbH
Sp. z o.o. Oddział w Polsce
(Branch Poland)
ul. 17 Sycznia 56
PL-02-146 Warszawa Poland
Tel: +48 (0)22 500 29 25
Fax: +48 (0)22 500 29 30

LIECHTENSTEIN

Yamaha Music Europe GmbH, Rellingen,
Branch Switzerland in Zurich
Seefeldstrasse 94, CH-8008
Zürich, Switzerland
Tel: +41 (0)44 3878080
Fax: +41 (0)44 3833918

LITHUANIA

Yamaha Music Europe GmbH
Sp. z o.o. Oddział w Polsce
(Branch Poland)
ul. 17 Sycznia 56
PL-02-146 Warszawa Poland
Tel: +48 (0)22 500 29 25
Fax: +48 (0)22 500 29 30

LUXEMBOURG

Yamaha Music Europe
Branch Benelux
Clariessenhof 5b NL, 4133 AB, Vianen
The Netherlands
Tel: +31 (0)347 358040
Fax: +31 (0)347 358060

MALTA

Olimpus Music Ltd.
The Emporium, Level 3, St. Louis Street
Msida MSD06
Tel: +356 (0)2133 2093
Fax: +356 (0)2133 2144

NETHERLANDS

Yamaha Music Europe
Branch Benelux
Clariessenhof 5b NL, 4133 AB, Vianen
The Netherlands
Tel: +31 (0)347 358040
Fax: +31 (0)347 358060

NORWAY

YS Oslo Liaison Office
(Yamaha Scandinavia AB Filial Norway)
Gini Naeringspark 1
1361 Osteras, Norway
Tel: +47 67 16 77 70
Fax: +47 67 16 77 79

POLAND

YAMAHA Music Europe GmbH
Sp. z o.o. Oddział w Polsce
ul. 17 Sycznia 56
02-146 WARSZAWA/POLSKA
Tel: +48 (0)22 500 29 25
Fax: +48 (0)22 500 29 30

PORTUGAL

Yamaha Musica Ibérica, S.A.U.
Sincoisai Portuguesa
Rua Alfredo da Silva
2610-016 Amadora, Portugal
Tel: +351 214 704 330
Fax: +351 214 718 220

ROMANIA

Yamaha Music Europe GmbH
Branch Austria (Central and Eastern Europe)
Schlegelgasse 20, A-1100 Wien Austria
Tel: +43 (0)1 602 03900
Fax: +43 (0)1 602 039051

SLOVAKIA

Yamaha Music Europe GmbH
Branch Austria (Central and Eastern Europe)
Schlegelgasse 20, A-1100 Wien Austria
Tel: +43 (0)1 602 03900
Fax: +43 (0)1 602 039051

SLOVENIA

Yamaha Music Europe GmbH
Branch Austria (Central and Eastern Europe)
Schlegelgasse 20, A-1100 Wien Austria
Tel: +43 (0)1 602 03900
Fax: +43 (0)1 602 039051

SPAIN

Yamaha Musica Ibérica, S.A.U.
Ctra. de la Corona km:17, 200
28230 Las Rozas de Madrid, Spain
Tel: +34 902 39 8686
Fax: +34 91 638 4660

SWEDEN

Yamaha Scandinavia AB
J A Wettergrens gata 1
Västtra Frolunda, Sweden
(Box 300 53, 400 43 Göteborg
Sweden - Postal Address)
Tel: +46 (0)31 893400
Fax: +46 (0)31 454026

SWITZERLAND

Yamaha Music Europe GmbH, Rellingen,
Branch Switzerland in Zurich
Seefeldstrasse 94, CH-8008
Zürich, Switzerland
Tel: +41 (0)44 3878080
Fax: +41 (0)44 3833918

UNITED KINGDOM

Yamaha Music UK Ltd.
Sherbourne Drive
Tilbrook, Milton Keynes MK7 9BL
United Kingdom
Tel: +44 (0)1908 369278
Fax: +44 (0)1908 369276

For details of products, please contact your nearest Yamaha representative or the authorized distributor listed below.

Die Einzelheiten zu Produkten sind bei Ihrer unten aufgeführten Niederlassung und bei Yamaha Vertragshändlern in den jeweiligen Bestimmungsländern erhältlich.

Pour plus de détails sur les produits, veuillez-vous adresser à Yamaha ou au distributeur le plus proche de vous figurant dans la liste suivante.

Para detalles sobre productos, contacte su tienda Yamaha más cercana o el distribuidor autorizado que se lista debajo.

Подробные сведения об инструменте можно получить у местного представителя корпорации Yamaha или уполномоченного дистрибьютора, указанного в следующем списке.

NORTH AMERICA

CANADA

Yamaha Canada Music Ltd.
135 Milner Avenue, Scarborough, Ontario,
M1S 3R1, Canada
Tel: 416-298-1311

U.S.A.

Yamaha Corporation of America
6600 Orangethorpe Ave., Buena Park, Calif. 90620,
U.S.A.
Tel: 714-522-9011

CENTRAL & SOUTH AMERICA

MEXICO

Yamaha de México S.A. de C.V.
Calz. Javier Rojo Gómez #1149,
Col. Guadalupe del Moral
C.P. 09300, México, D.F., México
Tel: 55-5804-0600

BRAZIL

Yamaha Musical do Brasil Ltda.
Rua Joaquim Floriano, 913 - 4º andar, Itaim Bibi,
CEP 04534-013 Sao Paulo, SP. BRAZIL
Tel: 011-3704-1377

ARGENTINA

Yamaha Music Latin America, S.A.
Sucursal de Argentina
Olga Cossetini 1553, Piso 4 Norte
Madero Este-C1107CEK
Buenos Aires, Argentina
Tel: 011-4119-7000

PANAMA AND OTHER LATIN

AMERICAN COUNTRIES/

CARIBBEAN COUNTRIES

Yamaha Music Latin America, S.A.
Torre Banco General, Piso 7, Urbanización Mar-
bella,
Calle 47 y Aquilino de la Guardia,
Ciudad de Panamá, Panamá
Tel: +507-269-5311

EUROPE

THE UNITED KINGDOM/IRELAND

Yamaha Music U.K. Ltd.
Sherbourne Drive, Tilbrook, Milton Keynes,
MK7 8BL, England
Tel: 01908-366700

GERMANY

Yamaha Music Europe GmbH
Siemensstraße 22-34, 25462 Rellingen, Germany
Tel: 04101-3030

SWITZERLAND/LIECHTENSTEIN

Yamaha Music Europe GmbH
Branch Switzerland in Zürich
Seefeldstrasse 94, 8008 Zürich, Switzerland
Tel: 044-387 8080

AUSTRIA

Yamaha Music Europe GmbH Branch Austria
Schleiergasse 20, A-1100 Wien, Austria
Tel: 01-60203900

CZECH REPUBLIC/SLOVAKIA/

HUNGARY/SLOVENIA

Yamaha Music Europe GmbH Branch Austria
Schleiergasse 20, A-1100 Wien, Austria
Tel: 01-602039025

POLAND/LITHUANIA/LATVIA/ESTONIA

Yamaha Music Europe GmbH
Branch Sp.z o.o. Oddział w Polsce
ul. 17 Stycznia 56, PL-02-146 Warszawa, Poland
Tel: 022-868-07-57

THE NETHERLANDS/ BELGIUM/LUXEMBOURG

Yamaha Music Europe Branch Benelux
Clarissenhof 5-b, 4133 AB Vianen, The Netherlands
Tel: 0347-358 040

FRANCE

Yamaha Musique France
BP 70-77312 Mame-la-Vallée Cedex 2, France
Tel: 01-64-61-4000

ITALY

Yamaha Musica Italia S.P.A.
Viale Italia 88, 20020 Lainate (Milano), Italy
Tel: 02-935-771

SPAIN/PORTUGAL

Yamaha Música Ibérica, S.A.
Ctra. de la Coruna km. 17, 200, 28230
Las Rozas (Madrid), Spain
Tel: 91-639-8888

GREECE

Philippou Nakas S.A. The Music House
147 Skiathou Street, 112-55 Athens, Greece
Tel: 01-228 2160

SWEDEN

Yamaha Scandinavia AB
J. A. Wettergrens Gata 1, Box 30053
S-400 43 Göteborg, Sweden
Tel: 031 89 34 00

DENMARK

YS Copenhagen Liaison Office
Generatorvej 6A, DK-2730 Herlev, Denmark
Tel: 44 92 49 00

FINLAND

F-Musiikki Oy
Kluuvikatu 6, P.O. Box 260,
SF-00101 Helsinki, Finland
Tel: 09 618511

NORWAY

Norsk filial av Yamaha Scandinavia AB
Grini Næringspark 1, N-1345 Østerås, Norway
Tel: 67 16 77 70

ICELAND

Skifan HF
Skeifan 17 P.O. Box 8120, IS-128 Reykjavik, Ice-
land
Tel: 525 5000

RUSSIA

Yamaha Music (Russia)
Office 4015, entrance 2, 21/5 Kuznetskii
Most street, Moscow, 107996, Russia
Tel: 495 626 0660

OTHER EUROPEAN COUNTRIES

Yamaha Music Europe GmbH
Siemensstraße 22-34, 25462 Rellingen, Germany
Tel: +49-4101-3030

AFRICA

Yamaha Corporation,
Asia-Pacific Music Marketing Group
Nakazawa-cho 10-1, Naka-ku, Hamamatsu,
Japan 430-8650
Tel: +81-53-460-2312

MIDDLE EAST

TURKEY/CYPRUS

Yamaha Music Europe GmbH
Siemensstraße 22-34, 25462 Rellingen, Germany
Tel: 04101-3030

OTHER COUNTRIES

Yamaha Music Gulf FZE
LOB 16-513, P.O.Box 17328, Jubel Ali,
Dubai, United Arab Emirates
Tel: +971-4-881-5868

ASIA

THE PEOPLE'S REPUBLIC OF CHINA

Yamaha Music & Electronics (China) Co.,Ltd.
2F, Yunhedasha, 1818 Xinzha-lu, Jingan-qu,
Shanghai, China
Tel: 021-6247-2211

HONG KONG

Tom Lee Music Co., Ltd.
11/F., Silvercord Tower 1, 30 Canton Road,
Tsimshatsui, Kowloon, Hong Kong
Tel: 2737-7688

INDIA

Yamaha Music India Pvt. Ltd.
5F Ambience Corporate Tower Ambience Mall Complex
Ambience Island, NH-8, Gurgaon-122001, Haryana, India
Tel: 0124-466-5551

INDONESIA

PT. Yamaha Music Indonesia (Distributor)
PT. Nusantik
Gedung Yamaha Music Center, Jalan Jend. Gatot
Subroto Kav. 4, Jakarta 12930, Indonesia
Tel: 21-520-2577

KOREA

Yamaha Music Korea Ltd.
8F, 9F, Dongsung Bldg. 158-9 Samsung-Dong,
Kangnam-Gu, Seoul, Korea
Tel: 080-004-0022

MALAYSIA

Yamaha Music Malaysia, Sdn. Bhd.
Lot 8, Jalan Perbandaran, 47301 Kelana Jaya,
Petaling Jaya, Selangor, Malaysia
Tel: 3-78030900

PHILIPPINES

Yupangco Music Corporation
339 Gil J. Puyat Avenue, P.O. Box 885 MCPO,
Makati, Metro Manila, Philippines
Tel: 819-7551

SINGAPORE

Yamaha Music Asia Pte., Ltd.
#03-11 A-Z Building
140 Paya Lebar Road, Singapore 409015
Tel: 747-4374

TAIWAN

Yamaha KHS Music Co., Ltd.
3F, #6, Sec.2, Nan Jing E. Rd. Taipei,
Taiwan 104, R.O.C.
Tel: 02-2511-8688

THAILAND

Siam Music Yamaha Co., Ltd.
4, 6, 15 and 16th floor, Siam Motors Building,
891/1 Rama 1 Road, Wangmai,
Pathumwan, Bangkok 10330, Thailand
Tel: 02-215-2626

OTHER ASIAN COUNTRIES

Yamaha Corporation,
Asia-Pacific Music Marketing Group
Nakazawa-cho 10-1, Naka-ku, Hamamatsu,
Japan 430-8650
Tel: +81-53-460-2317

OCEANIA

AUSTRALIA

Yamaha Music Australia Pty. Ltd.
Level 1, 99 Queensbridge Street, Southbank,
Victoria 3006, Australia
Tel: 3-9693-5111

NEW ZEALAND

Music Works LTD
P.O. BOX 6246 Wellesley, Auckland 4680,
New Zealand
Tel: 9-634-0099

COUNTRIES AND TRUST

TERRITORIES IN PACIFIC OCEAN

Yamaha Corporation,
Asia-Pacific Music Marketing Group
Nakazawa-cho 10-1, Naka-ku, Hamamatsu,
Japan 430-8650
Tel: +81-53-460-2312



Yamaha Home Keyboards Home Page
<http://music.yamaha.com/homekeyboard/>
Yamaha Manual Library
<http://www.yamaha.co.jp/manual/>

U.R.G., Pro Audio & Digital Musical Instrument Division, Yamaha Corporation
© 2009 Yamaha Corporation

WT79950 003POXXX.X-XXB0
Printed in China