



# RX-V795aRDS

*Natural Sound AV Receiver*  
*Ampli-tuner audio vidéo*

**OWNER'S MANUAL**  
**MODE D'EMPLOI**  
**BEDIENUNGSANLEITUNG**  
**BRUKSANVISNING**  
**MANUALE DI ISTRUZIONI**  
**MANUAL DE INSTRUCCIONES**  
**GEBRUIKSAANWIJZING**

# Congratulations!

You are the proud owner of a Yamaha Digital Sound Field Processing (DSP) System—an extremely sophisticated audio component. The DSP system takes full advantage of Yamaha's undisputed leadership in the field of digital audio processing to bring you a whole new world of listening experiences. Follow the instructions in this manual carefully when setting up your system, and the DSP system will sonically transform your room into a wide range of listening environments—anything from a famous concert hall to a cozy jazz club. In addition, you get incredible realism from most of surround-sound encoded video sources available in the market using the built-in Dolby Pro Logic Decoder, Dolby Digital Decoder and DTS Decoder.

Five built-in channels of amplification on this model mean that no additional amplifiers are required to enjoy advanced digital sound field processing.

Rather than tell you about the wonders of digital sound field processing, however, let's get right down to the business of setting up the system and trying out its many capabilities. Please read this operation manual carefully and store it in a safe place for later reference.

# CONTENTS

<b>CAUTION</b> .....	<b>2</b>	<b>BASIC OPERATION</b> .....	<b>33</b>
<b>INTRODUCTION</b> .....	<b>3</b>	Playing a source .....	33
Features .....	3	Recording a source to tape (or MD) or dubbing from tape (or MD) to tape (or MD) .....	37
What's DSP? .....	4	Sound control .....	38
<b>GETTING STARTED</b> .....	<b>7</b>	Tuning .....	39
Getting started .....	7	Basic operation .....	39
Unpacking .....	7	Preset tuning .....	40
Installing batteries in the remote controller .....	8	<b>Receiving RDS stations</b> .....	43
Notes about the remote controller .....	8	Displaying RDS data .....	43
<b>Controls and their functions</b> .....	<b>9</b>	Selecting your desired program type from among preset RDS stations (PTY SEEK) .....	46
Front panel .....	9	Automatic selection of desired program when broadcasting starts .....	47
Display panel .....	11	<b>Using digital sound field processor (DSP)</b> .....	48
<b>PREPARATION</b> .....	<b>12</b>	Playing a source with an effect of the digital sound field processor (DSP) .....	48
Speaker setup .....	12	Adjusting output level of the center, right rear, left rear speakers and subwoofer .....	51
<b>Connections</b> .....	<b>14</b>	Brief overview of digital sound field programs .....	53
Audio/video source equipment .....	14	<b>ADVANCED FEATURES</b> .....	<b>56</b>
Speakers .....	20	“SET MENU” mode .....	56
Antennas .....	23	Creating your own sound fields .....	60
Plugging in this unit .....	25	Setting the SLEEP timer .....	64
<b>On screen display</b> .....	<b>26</b>	<b>REMOTE CONTROLLER</b> .....	<b>65</b>
<b>Selecting the output modes</b> <b>(“SET MENU” mode)</b> .....	<b>27</b>	Basic operation .....	65
Speaker balance adjustment .....	30	Key name and function .....	66
		Entering manufacturer codes .....	71
		Restoring the default codes .....	72
		<b>TROUBLESHOOTING</b> .....	<b>73</b>
		<b>SPECIFICATIONS</b> .....	<b>76</b>
		<b>LIST OF MANUFACTURE'S CODE</b> ..... The end of this manual	

# CAUTION : Read this before operating your unit.

1. To assure the finest performance, please read this manual carefully. Keep it in a safe place for future reference.
2. Install this unit in a cool, dry, clean place – away from windows, heat sources, sources of excessive vibration, dust, moisture and cold. Avoid sources of humming (transformers, motors). To prevent fire or electrical shock, do not expose the unit to rain or water.
3. Never remove the unit cover. Contact your dealer if an object falls inside the unit.
4. Do not use force on switches, controls or connection wires. When moving the unit, first disconnect the power plug and the wires connected to other equipment. Never pull on the wires themselves.
5. The openings on the unit cover assure proper ventilation of the unit. If these openings are obstructed, the temperature inside the unit will rise rapidly. Therefore, avoid placing objects against these openings, and install the unit in a well-ventilated area to prevent fire and damage. Be sure to allow a space of at least 20 cm behind, 20 cm on the both sides and 30 cm above the top panel of the unit to prevent fire and damage.
6. The voltage used must be the same as that specified on this unit. Using this unit with a higher voltage than specified is DANGEROUS and may result in fire or other accidents. YAMAHA will not be held responsible for any damage resulting from use of this unit with a voltage other than specified.
7. Digital signals generated by this unit may interfere with other equipment such as tuners, receivers or TVs. Move this unit farther away from such equipment if interference is observed.
8. Always set the VOLUME control to “- ∞” before starting the audio source play. Increase the volume gradually to an appropriate level after playback has been started.
9. Do not attempt to clean the unit with chemical solvents; this might damage the finish. Use a clean, dry cloth.
10. Be sure to read the “TROUBLESHOOTING” section regarding common operating errors before concluding that the unit is faulty.
11. When not planning to use this unit for long periods of time, disconnect the AC power plug from the wall outlet.
12. To prevent lightning damage, disconnect the AC power plug and antenna cable when there is an electrical storm.
13. Grounding or polarization – Precautions should be taken so that the grounding or polarization of an appliance is not defeated.
14. Do not connect an audio unit to the AC outlet on the rear panel if the equipment requires more power than the outlet is rated to provide.

## IMPORTANT

Please record the serial number of your unit in the space below.

Model:

Serial No.:

The serial number is located on the rear of the unit. Retain this Owner's Manual in a safe place for future reference.

## WARNING

TO REDUCE THE RISK OF FIRE OR ELECTRIC SHOCK, DO NOT EXPOSE THIS UNIT TO RAIN OR MOISTURE.

This unit is not disconnected from the AC power source as long as it is connected to the wall outlet, even if this unit itself is turned off. This state is called the standby mode. In this mode, this unit is designed to consume a small amount of power.

## WARNING

**Do not change the IMPEDANCE SELECTOR switch setting while the power to this unit is on, otherwise this unit may be damaged.**

If this unit fails to turn on when the **STANDBY/ON** switch is pressed:

The **IMPEDANCE SELECTOR** switch may not be set to either end. If so, set the switch to either end when this unit is in the standby mode.

## IMPEDANCE SELECTOR

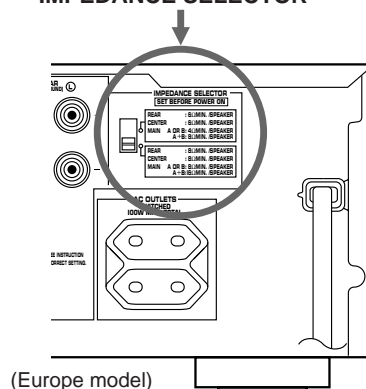

## For U.K. customers

If the socket outlets in the home are not suitable for the plug supplied with this appliance, it should be cut off and an appropriate 3 pin plug fitted. For details, refer to the instructions described below.

**Note:** The plug severed from the mains lead must be destroyed, as a plug with bared flexible cord is hazardous if engaged in a live socket outlet.

## Special Instructions for U.K. Model

### IMPORTANT

THE WIRES IN MAINS LEAD ARE COLOURED IN ACCORDANCE WITH THE FOLLOWING CODE:

Blue: NEUTRAL

Brown: LIVE

As the colours of the wires in the mains lead of this apparatus may not correspond with the coloured markings identifying the terminals in your plug, proceed as follows: The wire which is coloured BLUE must be connected to the terminal which is marked with the letter N or coloured BLACK. The wire which is coloured BROWN must be connected to the terminal which is marked with the letter L or coloured RED. Making sure that neither core is connected to the earth terminal of the three pin plug.

## Features

### 5 Channel Power Amplification

- Main:** 85W + 85W (8Ω) RMS Output Power, 0.04% THD, 20–20,000 Hz
- Center:** 85W (8Ω) RMS Output Power, 0.04% THD, 20–20,000 Hz
- Rear:** 85W + 85W (8Ω) RMS Output Power, 0.04% THD, 20–20,000 Hz

### Multi-Mode Digital Sound Field Processing

- Digital Sound Field Processor (DSP)
- Dolby Digital Decoder
- Dolby Pro Logic Decoder
- DTS Decoder
- CINEMA DSP: Theater-like Sound Experience by the Combination of YAMAHA DSP Technology and Dolby Digital, Dolby Pro Logic or DTS
- Automatic Input Balance Control for Dolby Pro Logic Decoding
- Test Tone Generator for Easier Speaker Balance Adjustment
- Speaker Output Mode Selection Capability for the Most Suitable Use of Your Speaker System

### Sophisticated FM/AM Tuner

- 40-Station Random Access Preset Tuning
- Automatic Preset Tuning
- Preset Station Shifting Capability (Preset Editing)
- Multi-Functions for RDS Broadcast Reception
- IF Count Direct PLL Synthesizer Tuning System

### Others

- “SET MENU” Mode which Provides You with 13 Titles of Setting Changes and Adjustments for Optimizing This Unit for Your Audio/Video System
- BASS EXTENSION Button for Reinforcing Bass Response
- On Screen Display Function Helpful in Controlling This Unit
- SLEEP Timer
- OPTICAL and COAXIAL Digital Audio Signal Terminals
- 6 Channel External Decoder Input for Other Future Formats
- Video Signal Input/Output Capability (Including S Video Connections)
- Universal Remote Controller with Preset Manufacturer Codes

## What's DSP?

### Introduction

---

Welcome to the exciting world of digital home entertainment. This unit is one of the most complete and advanced AV receiver available. Some of the more advanced features may not be familiar to you, but they are easy to use. State-of-the-art technologies such as Dolby Digital and Digital Theater Systems (DTS) may be new to your home, but you have probably experienced the amazing realism they bring to feature films in theaters around the world.

To make the listening experience even more enjoyable, this unit includes a number of exclusive, digitally created listening environments known as digital sound fields. Choosing a sound field program is like transporting yourself to such venues as an outdoor arena, a European church, or a cozy jazz club. Take some time now to read more about these features and enjoy the new experiences this unit brings to your home theater.

### Digital Sound Field Processing

---

Technological advances in sound reproduction over the last 30 years have enhanced the listening experience with improved clarity, precision and power. However, something has still been missing: The atmosphere and acoustic ambiance of the public venue. Our Yamaha engineers have extensively researched the nature of sound acoustics and the way sound reflects inside a room. We sent these engineers to famous theaters and concert halls around the world to measure the acoustics of those venues with sophisticated microphones. The data they collected is used to recreate these environments in digital sound fields. Some of these digital sound fields are created using data measured directly at the original venue; others are created from combinations of data to form unique environments for specific purposes.

Of course, that only solves half of the problem. These engineers have no way of knowing the acoustics of your listening room, so we've made it possible for you to adjust the various parameters of this data to tailor each virtual venue to your taste. You can use these sound fields to enhance any source and in combination with any of the following surround sound technologies. Some are designed especially for music, and some especially for movies.

### Dolby Pro Logic

---

Dolby Surround has been used in movie theaters since the mid-seventies. It has also been available in home entertainment systems since the late eighties and continues to be a popular format for home theater systems. It uses four discrete channels and five speakers to reproduce realistic and dynamic sound effects: two main channels (left and right), a center channel for dialog, and a rear channel for special sound effects. The rear channel reproduces sound within a narrow frequency range.

Most video tapes and laser discs include Dolby Surround encoding as do many TV and cable broadcasts. The Dolby Pro Logic decoder built into this unit employs a digital signal processing system that stabilizes each channel for even more accurate sound positioning than is available with standard analog processors.

## Dolby Digital

Dolby Digital is the next level of Dolby Surround sound system developed for 35 mm film-movies by employing low bit-rate audio coding.

Dolby Digital is a digital surround sound system that provides completely independent multi-channel audio to you. Dolby Digital provides five full range channels in what is sometimes referred to as a "3/2" configuration: three front channels (left, center and right), and two surround channels. A sixth bass-only effect channel is also provided for output of LFE (low frequency effect), or low bass effects that are independent of other channels. (This is called the "LFE channel".) This channel is counted as 0.1, thus giving rise to the term 5.1 channels in total.

Compared to Dolby Surround that is referred to a "3/1" system (left front, center, right front and just one surround channel), Dolby Digital features two surround channels, called stereo or split surrounds, each offering the same full range fidelity as the three front channels.

By using the built-in Dolby Digital decoder, you can experience the dramatic realism and impact of Dolby Digital theater sound in your home.

Wide dynamic range of sound reproduced by the five full range channels and precise sound orientation by the digital sound processing presents listeners much excitement and realism that has never been experienced before.

## DTS Digital Surround

DTS (Digital Theater Systems) system was developed to replace analog soundtracks of movies with six discrete channels of digital soundtracks, and now, it is installed in many theaters around the world. The DTS digital playback system changed the way we experienced movies in theaters with six discrete channels of superb digital audio.

The DTS technology, through intense research and development, made it possible to deliver a similar encode/decode discrete technology to home audio surround-sound entertainment.

The DTS Digital Surround is an encode/decode system which delivers six channels of master-quality, 20-bit audio; technically 5.1 channels, which means 5 full-range (left, center, right and two surround) channels, plus a subwoofer (LFE) channel (as "0.1"). It is compatible with the 5.1 speaker configurations that are currently available for home theater systems

The DTS Digital Surround algorithm is designed to encode the six channels of 20-bit audio onto some laserdiscs, compact discs and DVDs with considerably less data-compression.

Dolby Digital forms 5.1 channels as mentioned left, and moreover, it can also form fewer channels, for example 2 channel stereo and monaural. You may be able to find some 2 channel stereo and/or monaural sources encoded with Dolby Digital in the market.

Laserdisc and DVD are home audio formats that could benefit from Dolby Digital. In the near future, Dolby Digital will also be applied to DBS, CATV and HDTV. The ongoing release of Dolby Digital theatrical films now underway will provide an immediate source of Dolby Digital encoded video software.



Manufactured under license from Dolby Laboratories. "Dolby", "Pro Logic" and the double-D symbol are trademarks of Dolby Laboratories.

By using the DTS decoder built into this unit, you can experience the dramatic realism and impact of the DTS installed theater's high quality sound in your home.

Laserdisc, compact disc and DVD are home audio format within which DTS can represent its high quality multi-channel audio. (In addition to movies on laserdiscs, many exciting new multi-channel music recordings will also become available in the form of DTS-encoded compact discs.)



Manufactured under license from Digital Theater Systems, Inc. US Pat. No. 5,451,942 and other world-wide patents issued and pending. "DTS", "DTS Digital Surround", are trademarks of Digital Theater Systems, Inc. Copyright 1996 Digital Theater Systems, Inc. All Rights Reserved.

## CINEMA DSP: Dolby Surround + DSP / DTS + DSP

The Dolby Surround sound and DTS systems show their full ability in a large movie theater, because movie sounds are originally designed to be reproduced in a large movie theater that uses a multitude of speakers. Trying to create a sound environment similar to that of a movie theater in your home is difficult because of the room size, material inside the walls, the number of speakers, and so on. In other words, your listening room is very different from a movie theater.

However, Yamaha DSP technology allows you to create nearly the same sound experience as that of a large movie theater in your home by compensating for the lack of presence and dynamics in the listening room with original digital sound fields combined with Dolby Surround or DTS Digital Surround sounds.

### **CINEMA DSP**

The YAMAHA "CINEMA DSP" logo indicates those programs that are created by the combination of YAMAHA DSP technology and Dolby Surround or DTS.

#### **Dolby Pro Logic + 2 Digital Sound Fields**

Digital sound fields are created on the presence side and the rear surround side of the Dolby Pro Logic decoded sound field respectively. They create a wide acoustic environment and emphasize surround-effect in the room, letting you feel much presence as if you were watching a movie in a popular Dolby Surround theater.

For details, refer to pages 53 to 54.

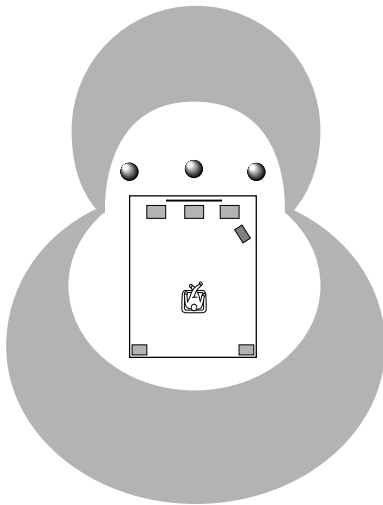

#### **Dolby Digital or DTS + 3 Digital Sound Fields**

Digital sound fields are created on the presence side and the independent left and right surround sides of the Dolby Digital-decoded or the DTS-decoded sound field respectively. They create a wide acoustic environment and much surround effect in the room without losing high channel separation. With wide dynamic range of Dolby Digital or DTS sound, this sound field combination lets you feel as if you were watching a movie in the newest Dolby Digital theater or DTS installed theater. This is the most ideal home theater sound at the present time.

For details, refer to pages 53 to 54.

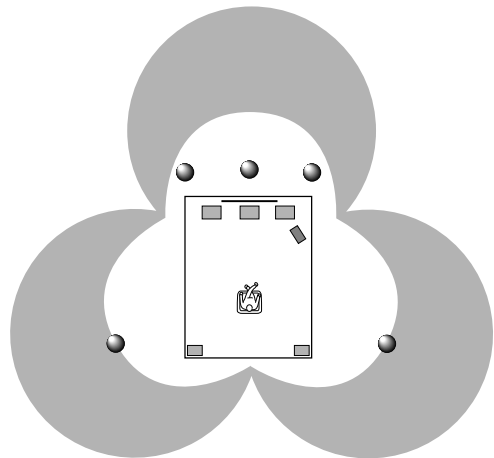



## Getting started

### Unpacking

Carefully remove this unit and accessories from the box. You should find the unit itself and the following accessories.

Remote controller

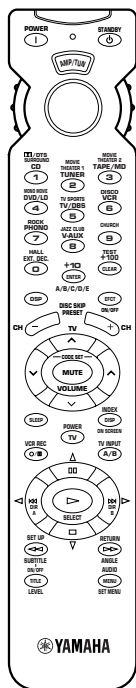

Indoor FM Antenna

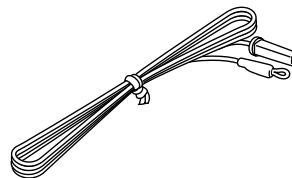

AM Loop Antenna

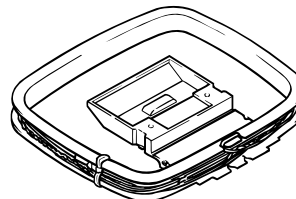

Batteries (size AA, R6, UM-3)

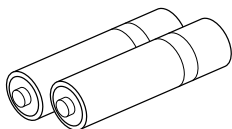

## Installing batteries in the remote controller

Since the remote controller will be used for many of this unit's control operations, you should begin by installing the supplied batteries.

1. Turn the remote controller over and slide the battery compartment cover in the direction of the arrow.
2. Insert the batteries (AA, R6, UM-3 type) according to the polarity markings on the inside of the battery compartment.
3. Close the battery compartment cover.

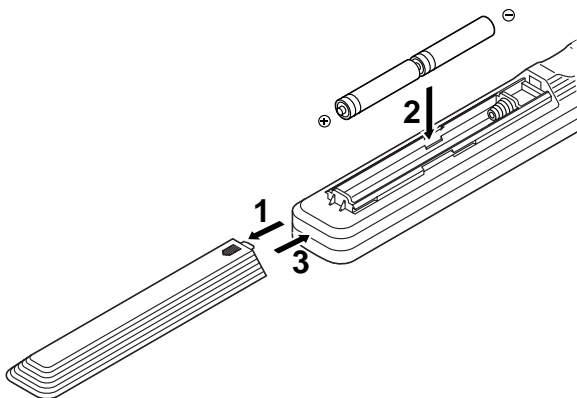

## Notes about the remote controller

### Battery replacement

If you find that the remote controller must be used closer to the main unit, the batteries are weak. Replace both batteries with new ones.

#### Notes

- Use AA, R6, UM-3 batteries.
- Be sure the polarities are correct. (See the illustration inside the battery compartment.)
- Remove the batteries if the remote controller is not used for an extended period of time.
- If batteries leak, dispose of them immediately. Avoid touching the leaked material and contact with clothing, etc. Clean the battery compartment thoroughly before installing new batteries.

Be sure to insert the new batteries within 2 minutes after you remove the old batteries from the remote controller. If the remote controller is left for more than 2 minutes without batteries, all of the codes you entered will be cleared and the remote controller will return to the factory preset condition.

### Remote controller operation range

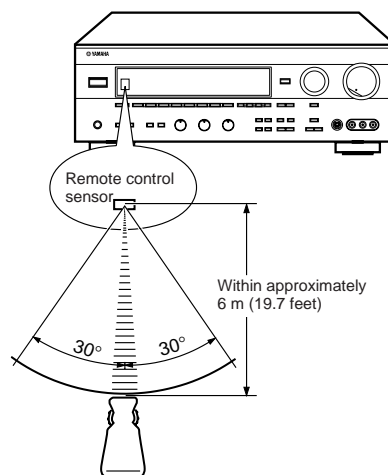

#### Notes

- The area between the remote controller and the main unit must be clear of large obstacles.
- Do not expose the remote control sensor to strong lighting, in particular, an inverter type fluorescent lamp. Otherwise, the remote controller may not work properly. If necessary, position the main unit away from direct lighting.

# Controls and their functions

## Front panel

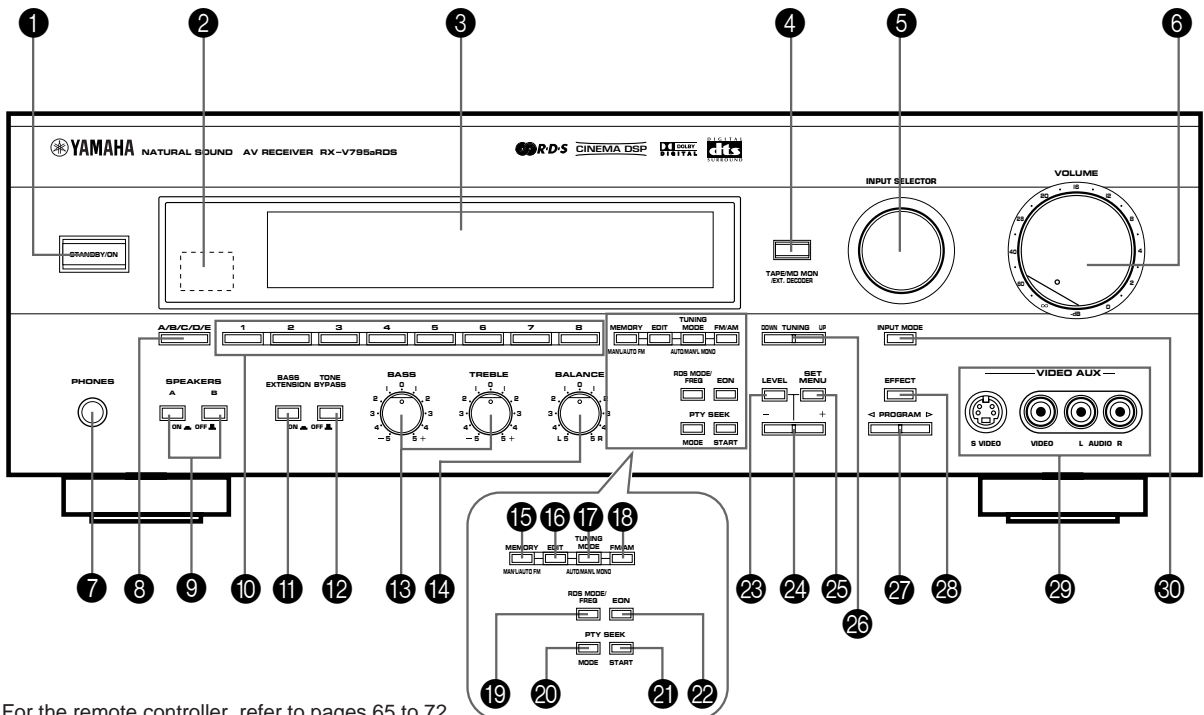

For the remote controller, refer to pages 65 to 72.

### 1 STANDBY/ON switch

Press this switch to turn on the power. Press this switch again to set this unit in the standby mode.

\* A click from the switch and the initial rotation of the built-in fan will be heard when the power is turned on.

#### Standby mode

This unit is still using a small amount of power in this mode in order to be ready to receive infrared-signals from the remote controller.

### 2 Remote control sensor

Receives signals from the remote controller.

### 3 Display panel

Displays a variety of information. (Refer to page 11 for details.)

### 4 TAPE/MD MON/EXT. DECODER button

Press this button repeatedly until the "TAPE/MD MONITOR" indicator is illuminated on the display. Sound source played or recorded on the unit connected to the TAPE/MD IN (PLAY)/OUT (REC) AUDIO SIGNAL terminals on the rear of this unit is selected as the input source taking priority of the **INPUT SELECTOR**'s setting.

Press this button repeatedly until the "EXT. DECODER" appears on the display. Sound signals input to the EXTERNAL DECODER INPUT terminals on the rear of this unit is selected as the input source taking priority of the **INPUT SELECTOR**'s setting.

Press this button repeatedly until the original display mode is restored to cancel the above input sources.

### 5 INPUT SELECTOR

Turn this knob to select the input source.

The selected source will be shown on the display.

### 6 Master VOLUME control

Simultaneously controls volume for all output sounds; main, rear, center and subwoofer. (The REC OUT level is not affected.)

\* The indicator on the master **VOLUME** control will flash when the volume is decreased by pressing the **MUTE** key on the remote controller.

### 7 PHONES jack

Headphones can be plugged into this jack for private listening. You can listen to the sound to be output from the main speakers through headphones. When listening with headphones privately, set both **SPEAKERS A** and **B** switches to the OFF position and turn off the digital sound field processor by pressing the **EFFECT** button so that no DSP program name is illuminated on the display panel.

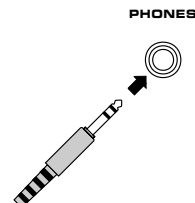

**8 A/B/C/D/E button**

Press this button to select a group (A–E) of preset stations.

**9 SPEAKERS switches**

Press the switch A or B (or both) for the main speakers you will use inward (ON). Press and release the switch for the main speakers you do not use outward (OFF).

**10 Preset station number selector buttons**

Select a preset station number (1 to 8).

**11 BASS EXTENSION button**

Press this button inward (ON) to boost the bass frequency response at the main left and right channels while maintaining overall tonal balance. This function is effective for reinforcing the bass frequencies when a subwoofer is not used.

**12 TONE BYPASS button**

Press this button inward (ON) to bypass the tone (BASS and TREBLE) control circuitry. This function is used for outputting pure sound and checking the tone control settings. The tone control circuitry can be used when this button is released outward (OFF).

**13 BASS and TREBLE controls**

Rotate these knobs to adjust the low and high frequency response for the left and right main channels only.

**14 BALANCE control**

This knob controls the sound from the main speakers only. The balance of the output volume to the left and right main speakers can be adjusted to compensate for sound imbalances caused by the speaker location or listening room conditions.

**15 MEMORY (MAN'L/AUTO FM) button**

Use this button to enter a station to memory. Refer to the section "Manual preset tuning" on page 40 for details. Hold down this button for more than 3 seconds to start automatic preset tuning. Refer to page 41 for details.

**16 EDIT button**

This button is used to exchange the places of two preset stations with each other.

**17 TUNING MODE (AUTO/MAN'L MONO) button**

Press this button to switch the tuning mode between automatic and manual. To select the automatic tuning mode, press this button so that the "AUTO" indicator is illuminated on the display. To select the manual tuning mode, press this button so that the "AUTO" indicator is not illuminated.

**18 FM/AM button**

Press this button to switch the reception band between FM and AM.

**19 RDS MODE/FREQ button**

When an RDS station is received, pressing this button changes the display mode into the PS mode, PTY mode, RT mode and/or CT mode (if the station employs these RDS data services), and frequency display in turn.

**20 PTY SEEK MODE button**

Press this button to set the unit to the PTY SEEK mode.

**21 PTY SEEK START button**

Press this button to begin searching for a station after the desired program type is selected in the PTY SEEK mode.

**22 EON button**

Press this button to select a desired program type (NEWS, INFO, AFFAIRS, SPORT) when you want to call a radio program of that program type automatically.

**23 LEVEL button**

This button is used to adjust the output level of the center and rear speakers, and subwoofer. First, press this button (several times) to select the speaker(s). The name appears on the display. Then press the + or – button (24) to change the output level.

**24 +/- button**

Adjusts the level of the speaker(s) selected by pressing the LEVEL button. Moreover, performs setting changes and adjustments for functions selected by pressing the SET MENU button (25).

**25 SET MENU button**

Press this button once or more to select the desired function in the SET MENU mode.

**26 TUNING DOWN/UP button**

Used for tuning. Press the "UP" side to tune in to a higher frequency, and press the "DOWN" side to tune in to a lower frequency.

When this unit is in the PTY SEEK mode, pressing this button changes the currently selected program type.

**27 PROGRAM selector button**

Press this button in the ◀ or ▶ direction to select a digital sound field processing program.

**28 EFFECT button**

Press this button to turn on and off the output from the center and rear speakers. The sound becomes normal 2-channel when this function is turned off. However, this does not apply to Dolby Digital or DTS. The signals at all channels will be distributed to the main channels and output from the main speakers, even if the output from the center and rear speakers are turned off, when Dolby Digital or DTS is decoded.

**29 VIDEO AUX terminals**

Connect an auxiliary video or audio input source unit such as a camcorder to these terminals. A video unit with a S video output terminal can be connected to the S VIDEO terminal to obtain a high resolution picture. The source can be selected with the INPUT SELECTOR.

**30 INPUT MODE button**

Press this button to select how input signals are received from sources that output two or more types of signals. The "AUTO", "DTS" and "ANALOG" modes are available. Refer to page 36 for details.

## Display panel

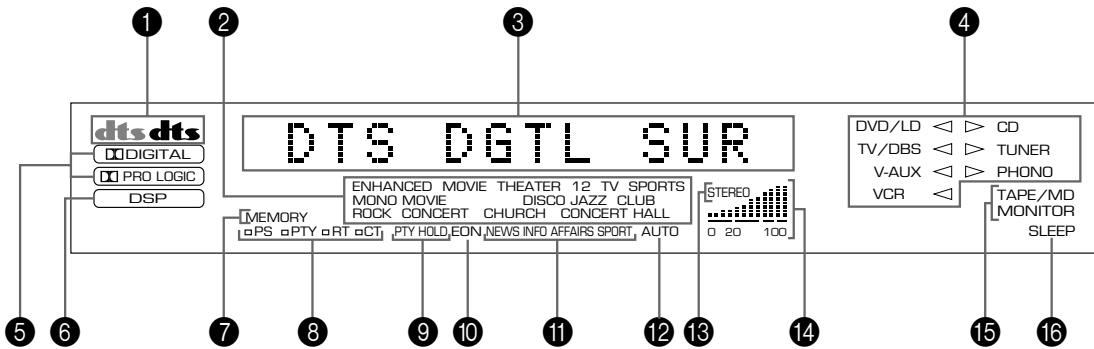

### 1 dts indicators

Either “dts” indicators will be illuminated when the built-in DTS decoder is turned on.

A red “dts” indicator will be illuminated when playing a compact disc or laserdisc encoded with DTS.

An orange “dts” indicator will be illuminated when playing a DVD encoded with DTS.

An orange “dts” indicator may be illuminated when playing a laserdisc encoded with DTS after a video-CD or DVD on a DVD/LD combi-player.

### 2 DSP program indicators

The name of the selected DSP program will be illuminated in the following cases.

- When the tuner is selected as the input source.
- When a DSP program parameter is selected or adjusted.
- When the DSP program No. 2, 3 or the subprogram “Enhanced” of No. 1 is selected.

There is no illumination here when no DSP program is selected.

### 3 Multi-information display

This display shows the current DSP program and the status of adjustments and setting changes. Several statuses can be viewed at one time. The current station frequency and band (AM or FM) will also appear when the tuner source input mode is selected.

### 4 Input source indicators

One of the arrows for these indicators will be illuminated depending on which source is selected.

### 5 DIGITAL and PRO LOGIC indicators

The DIGITAL indicator will be illuminated when the built-in Dolby Digital decoder is on and the signals of the source encoded with Dolby Digital are not 2-channels.

The PRO LOGIC indicator will be illuminated when the built-in Dolby Pro Logic decoder is on.

### 6 DSP indicator

This indicator will be illuminated when the built-in digital sound field processor is on.

### 7 MEMORY indicator

A flashing MEMORY indicator means a station can be saved, as explained in the following:

Press the **MEMORY** button. The MEMORY indicator will flash about 5 seconds. While the indicator is flashing, program the displayed station to memory by using the **A/B/C/D/E** and the **preset station number selector buttons**.

### 8 RDS mode indicators

The name(s) of the RDS mode(s) employed by the currently received RDS station is (are) illuminated. Illumination of the indicator on the head of a name shows that the corresponding RDS mode is now selected.

### 9 PTY HOLD indicator

This indicator will be illuminated while the search is performed in the PTY SEEK mode.

### 10 EON indicator

This indicator will be illuminated when an RDS station that employs the EON data service is received.

### 11 Program type name indicators

The name selected in the EON mode is illuminated.

### 12 AUTO indicator

This indicator will be illuminated during the automatic tuning mode.

### 13 STEREO indicator

This indicator will be illuminated when an FM stereo broadcast with sufficient signal strength is received.

### 14 Signal-level indicator

This indicator shows the signal level of the received station. If multipath interference is detected, the indication decreases.

### 15 TAPE/MD MONITOR indicator

This indicator will be illuminated when the tape deck (or MD recorder etc.) connected to the TAPE/MD IN and OUT terminals on the rear of this unit is selected as the input source by pressing the **TAPE/MD MON/EXT. DECODER** button.

### 16 SLEEP indicator

This indicator will be illuminated when the built-in SLEEP timer is on.

## Speaker setup

### ■ Setting up your speaker system

This unit has been designed to provide the best sound field quality with a full five-speaker system setup, using a pair of main speakers to output main source sounds, a pair of effect speakers to generate the sound field plus one center speaker for dialog. We therefore recommend that you use a five-speaker setup. A four-speaker system using only one pair of effect speakers for the sound field will still provide impressive ambience and effects, however, and may be a good way to begin with this unit. You can always upgrade to the five-speaker system later.

### Use of the center dialog speaker is recommended

When playing back a source with Dolby Pro Logic decoded, or playing back a source which contains center-channel signals with Dolby Digital or DTS decoded, dialog, vocals etc. are output from the center channel. Therefore, if you want to maximize the performance of your Audio/Video home theater system, it is recommended that you use a center channel speaker.

If, for some reason, it is not practical to use a center speaker, it is possible to enjoy the movie without it. Best results, however, are obtained with the full system.

### Use of a subwoofer expands your sound field

It is also possible to further expand your system with the addition of a subwoofer and amplifier. The use of a subwoofer is effective not only for reinforcing bass frequencies from any or all channels, but also for reproducing signals at the subwoofer channel with high fidelity during playing back a source with Dolby Digital or DTS decoded. You may wish to choose the convenience of a Yamaha Active Servo Processing Subwoofer System, which has its own built-in power amplifier.

### ■ Speakers and speaker placement

Your full five-speaker system will require two speaker pairs: the MAIN SPEAKERS (your normal stereo speakers) and the REAR SPEAKERS, plus the CENTER SPEAKER. You may also be using a SUBWOOFER.

The MAIN SPEAKERS should be high performance models and have enough power handling capacity to accept the maximum output of your audio system.

Other speakers do not have to be equal to the MAIN SPEAKERS. For precise sound localization, however, it is ideal to use high performance models that can reproduce sounds in full range for the CENTER SPEAKER and REAR SPEAKERS.

Place the MAIN SPEAKERS in the ordinary position.

Place the REAR SPEAKERS behind your listening position. They should be nearly 1.8m above the floor.

Place the CENTER SPEAKER precisely between the two MAIN SPEAKERS. (To avoid interference, keep the speaker above or below the television monitor, or use a magnetically shielded speaker.)

If using a SUBWOOFER, such as a Yamaha Active Servo Processing Subwoofer System, the position of the speaker is not so critical because low bass tones are not highly directional.

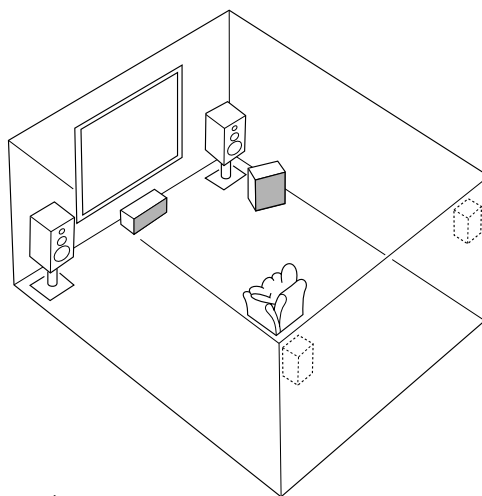

Main speaker



Center speaker



Rear speaker



Subwoofer

## ■ Speaker system configurations

### 5 Speaker System

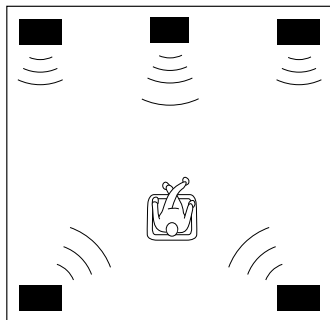

**The recommended system for enjoying Audio/Video sources.**

By the use of a center speaker, center channel sounds (dialog, vocals etc.) are precisely localized.

- 
1. **CENTER SPEAKER**—Set to “LRG” or “SML”.  
(See page 27.)

### 4 Speaker System

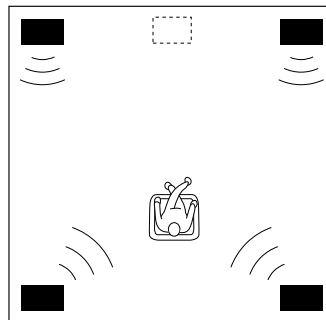

**Basic system.**

You can enjoy widely diffused sound by only adding a pair of rear speakers to a basic stereo speaker system. However, center channel sounds must be output from the left and right main speakers.

- 
1. **CENTER SPEAKER**—Set to “NONE”.  
(See page 27.)

# Connections

## Caution: Plug in this unit and other components after all connections are completed.

All connections must be correct, that is to say L (left) to L, R (right) to R, “+” to “+” and “-” to “-”. Also refer to the owner’s manual for each of your components.

### Audio/video source equipment

- Use RCA type pin plug cables for audio/video units with the exception described later.
- The output (or input) terminals of YAMAHA audio/video units numbered as 1, 3, 4, etc. on the rear panel must be connected to the same-numbered terminals of this unit.

### Basic connections

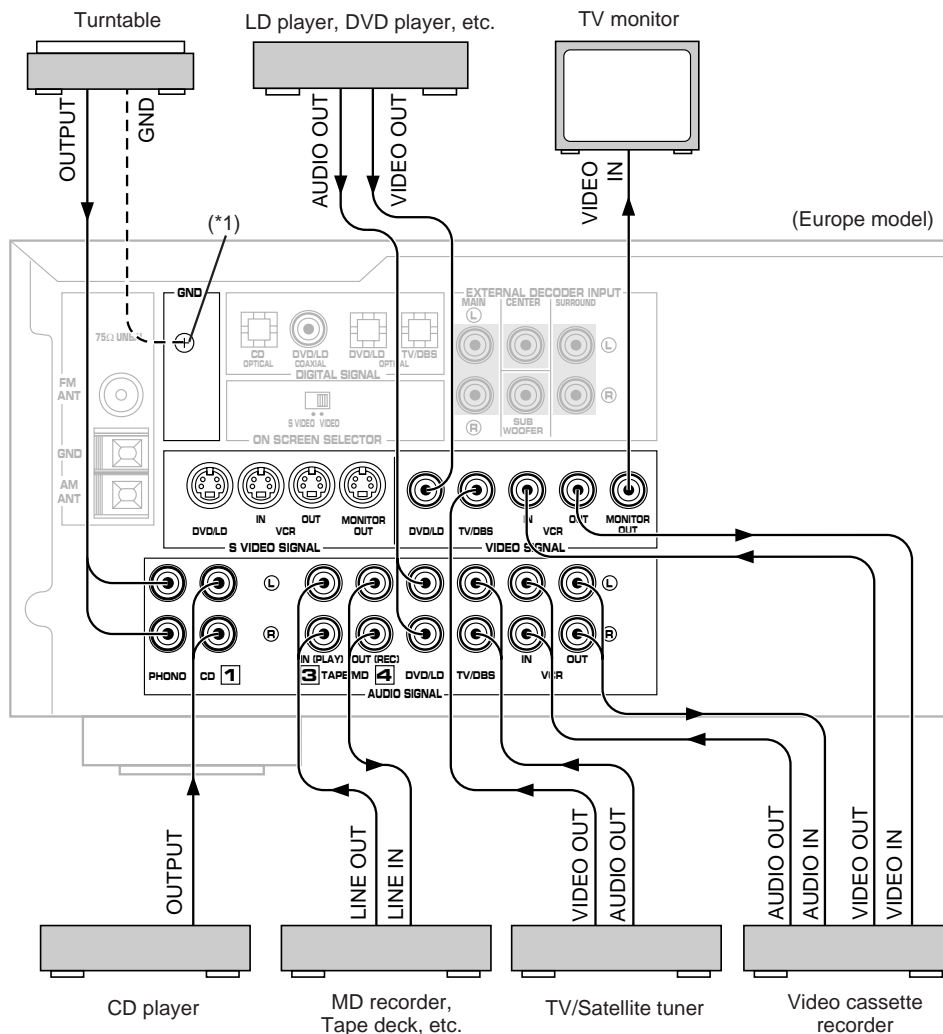

(\*1): **GND terminal (For turntable use)**

Connecting the ground wire of the turntable to the **GND** terminal will normally minimize hum, but in some cases better results may be obtained with the ground wire disconnected.

➔: Indicates the direction of signals.



### VIDEO AUX terminals (on the front panel)

These terminals are used to connect a video input source such as a camcorder.

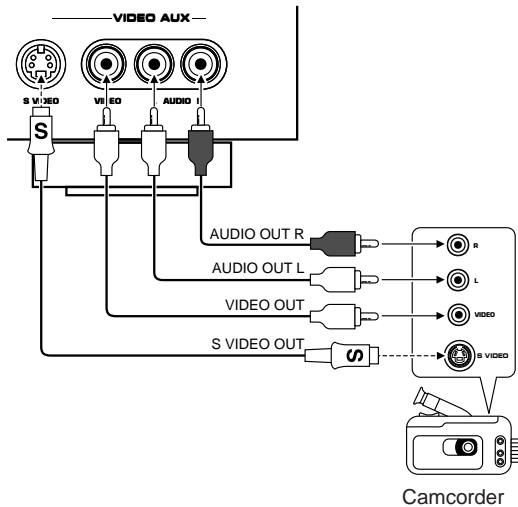

 : S-video cable  
 (Refer to page 18 for details about the S VIDEO terminal.)

### For connecting with a TV monitor that uses a 21 pin connector for input

Make a connection as figured below with a commercially available scart-plug connector cable.

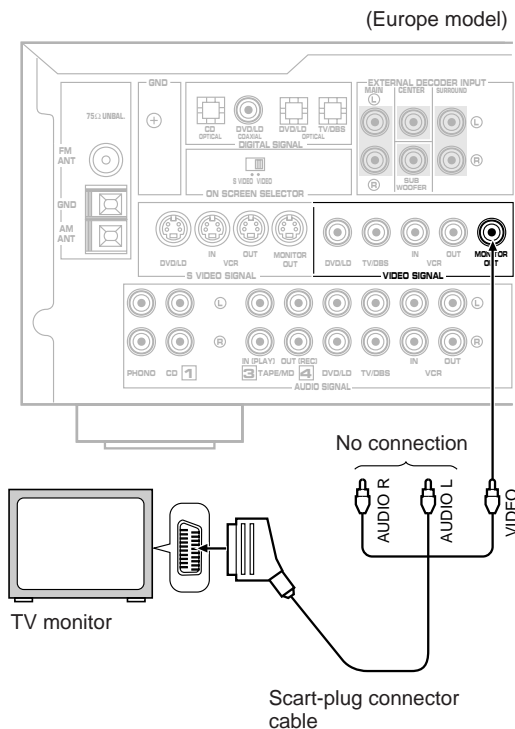

## ■ Connecting to digital (OPTICAL and COAXIAL) terminals

If your CD player, LD player, DVD player, TV/satellite tuner, etc. are equipped with coaxial or optical digital audio signal output terminals, they can be connected to this unit's COAXIAL or OPTICAL, or both terminals.

Digital audio signals are transmitted with less loss than analog audio signals. In addition, digital audio signal connections are necessary, especially for an LD player, a DVD player or a CD player to send signals encoded with Dolby Digital or DTS to this unit.

To make an optical digital connection between this unit and an external unit, remove the cover from each optical terminal, and then connect them by using a commercially available optical fiber cable that conforms to EIAJ standards. Other cables might not function correctly.

Even if you connect an audio/video unit to the OPTICAL (or COAXIAL) terminal of this unit, you must keep the unit connected with the same named analog audio signal terminals of this unit, because digital signal cannot be recorded by a tape deck or VCR connected to this unit. You can switch the selection of input signals between "digital" and "analog" easily. (See page 36 for details.)

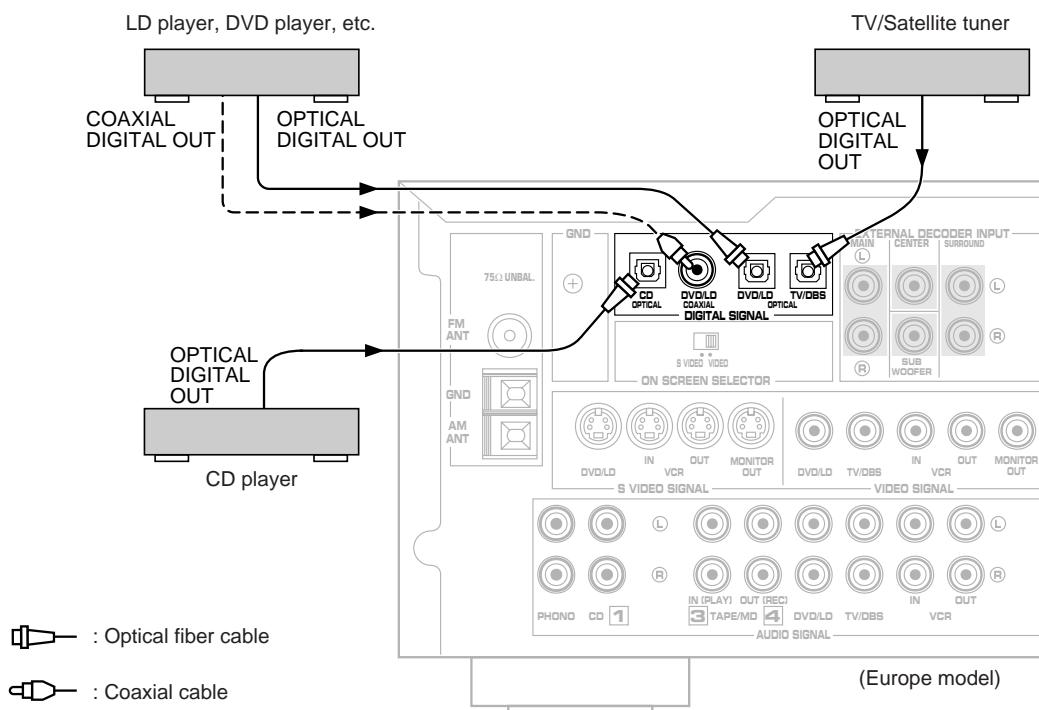

### Notes

- When you connect an audio/video unit to both of the digital and analog terminals of this unit, make sure to connect to both terminals of the same name.
- Be sure to attach the covers when the OPTICAL terminals are not being used, in order to protect the terminals from dust.
- The DOLBY DIGITAL RF signal output terminal of your DVD/LD/CD combi-player, etc. cannot be connected directly to this unit's DVD/LD COAXIAL terminal. See page 17 for proper connections to reproduce an LD source encoded with Dolby Digital.
- In order to make this unit perform successful DTS-decoding, the DTS bitstream must not be altered, manipulated or corrupted in the process of sending the DTS bitstream from the DIGITAL OUT terminal of an external unit to a digital signal input terminal of this unit.
- All digital audio signal input terminals are applicable to the sampling frequency of 32 kHz, 44.1 kHz and 48 kHz.

## ■ Connecting to DOLBY DIGITAL RF output of the DVD/LD/CD combi-player

If your DVD/LD/CD combi-player has a DOLBY DIGITAL RF signal output terminal, it can be connected to this unit by using an RF demodulator (separate purchase).

First, connect the DOLBY DIGITAL RF signal output terminal of the DVD/LD/CD combi-player to the DOLBY DIGITAL RF signal input terminal of the RF demodulator. Next, connect the coaxial digital signal output terminal of the RF demodulator to the COAXIAL digital signal input terminal of this unit.

This connection is necessary for sending audio signals of an LD source encoded with Dolby Digital to this unit.

It is also necessary to connect the DVD/LD/CD combi-player to this unit's analog audio signal input terminals regardless of the DOLBY DIGITAL RF signal connection.

You must also connect the optical digital signal output terminal of the DVD/LD/CD combi-player to the OPTICAL DVD/LD digital signal input terminal of this unit.

This connection is necessary for playing back a DVD source with Dolby Digital or DTS decoded, and playing back an LD source with DTS decoded.

When these connections are completed, set the input mode of the DVD/LD source to "AUTO", and you will hear sounds decoded with Dolby Digital even if signals are input to both COAXIAL and OPTICAL digital signal input terminals of this unit. This is because signals input to the COAXIAL terminal take priority over signals input to the OPTICAL terminal. Refer to page 36 for details about switching the input mode.

### Notes

- If, for example, you play a CD on the DVD/LD/CD combi-player, there is no input to the COAXIAL terminal, so the signals input to the OPTICAL terminal take priority. In this case, switch off the RF demodulator to listen to CD sound without interference. However, if your RF demodulator is the Yamaha model APD-1, you do not have to switch it off.
- When you want to play an LD source encoded with Dolby Digital without decoding Dolby Digital, you must switch off the power of the RF demodulator.

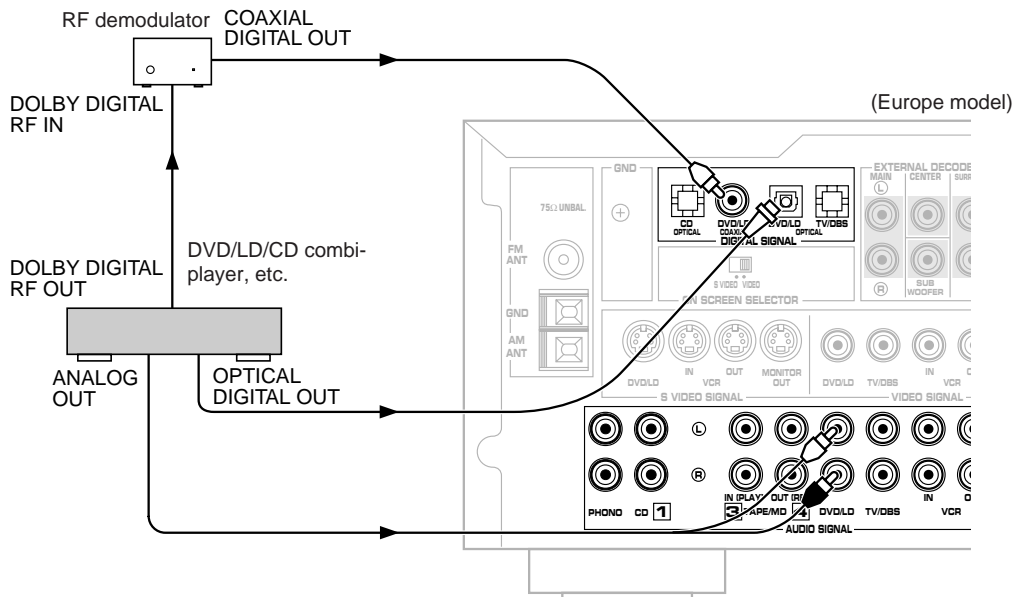

## ■ Connecting to S VIDEO terminals

If your monitor has an "S" video input terminal and your video cassette recorder, LD player, DVD player, etc. also have "S" video terminals, connect them to this unit's S VIDEO SIGNAL terminals as illustrated below. In addition, a video unit which has an "S" video output can be connected to the VIDEO AUX S VIDEO terminal on the front of this unit.

With these connections, you can play back or record high quality pictures. Otherwise, connect the "composite" video terminals of your monitor, video cassette recorder, LD player, DVD player, etc. to the "composite" VIDEO SIGNAL terminals of this unit.

### Note

If video signals are sent to both S VIDEO input and VIDEO input terminals, the signals will be sent to their respective output terminals.

### S VIDEO terminals

This unit provides you with S VIDEO terminals in addition to standard type VIDEO terminals. S VIDEO terminals transmit video signals separated into luminance (Y) signals and color (C) signals. In comparison with S VIDEO terminals, standard type VIDEO terminals transmit "composite" video signals.

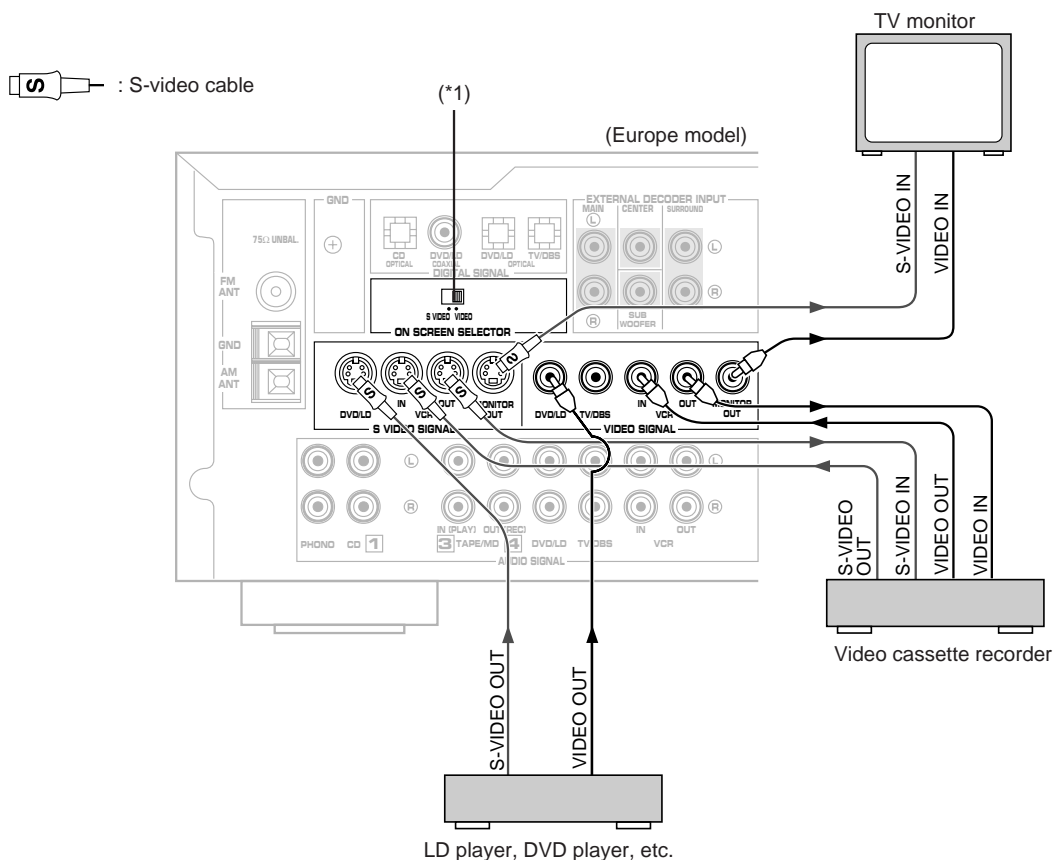

### (\*1): ON SCREEN SELECTOR S VIDEO/VIDEO switch

Set this switch to either position to select the TV monitor on which you want to display the on-screen information.

**S VIDEO:** The on-screen information is displayed on the TV monitor connected to the S VIDEO SIGNAL MONITOR OUT terminal.

**VIDEO:** The on-screen information is displayed on the TV monitor connected to the composite VIDEO SIGNAL MONITOR OUT terminal.

## ■ Connecting an external decoder of a future format to this unit

This unit is equipped with additional 6-channel audio signal input terminals (for left main, right main, center, left rear surround, right rear surround and subwoofer channels) for inputting signals from an external decoder of a future format to this unit.

To listen to a sound by reproducing signals input to these terminals, press the **TAPE/MD MON/EXT. DECODER** button on the front panel repeatedly until "EXT. DECODER" appears on the display. By doing so, the signals input to these terminals are sent to the corresponding **SPEAKERS** terminals and **OUTPUT** terminals of this unit.

### Notes

- When signals input to these terminals are selected, the digital sound field processor cannot be used.
- The settings of "1. CENTER SPEAKER," "2. REAR SPEAKER," "3. MAIN SPEAKER" and "4. LFE/BASS OUT" in the SET MENU mode have no effect on the signals input to these terminals. The setting of "5. MAIN LEVEL" is effective. (Refer to pages 27 to 28 for details.)
- The adjustments of the output level of the center speakers, rear speakers and subwoofer are effective when the signals input to these terminals are selected as the input source. (Refer to pages 51 to 52 for details.)

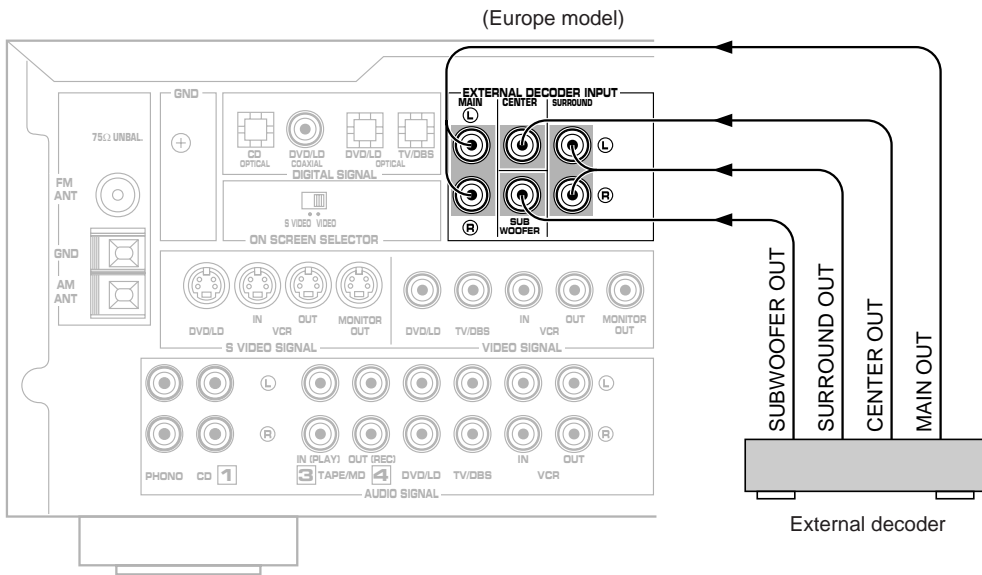

# Speakers

Use speakers with the specified impedance shown on the rear of this unit.

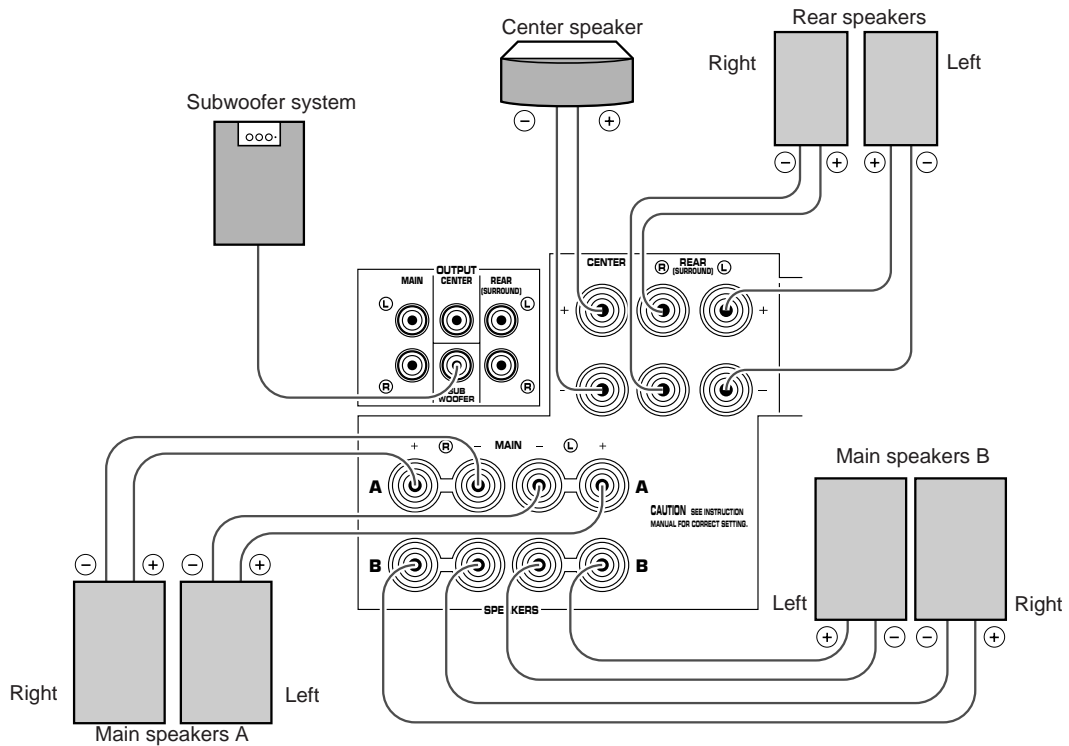

## How to Connect:

Connect the **SPEAKERS** terminals to your speakers with the wire of the proper gauge (keep as short as possible). If the connections are faulty, no sound will be heard from the speakers. Make sure that the polarity of the speaker wires is correct. That is the + and – markings are observed. If these wires are reversed, the sound will be unnatural and lack bass.

### Caution

Do not let the bare speaker wires touch each other or any metal part of this unit. This could damage this unit or the speakers, or both.

Red: positive (+)  
Black: negative (-)

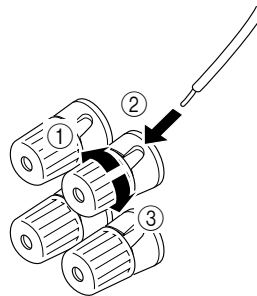

- ① Loosen the knob.
- ② Insert the bare wire.  
[Remove approx. 5mm (1/4") insulation from the speaker wires.]
- ③ Tighten the knob and secure the wire.

**Note on main speaker connections:**

One or two speaker systems can be connected to this unit. If you use only one speaker system, connect it to either the **SPEAKERS A** or **B** terminals.

**Note on a subwoofer connection:**

You may wish to add a subwoofer to reinforce low frequencies or to output low bass sound from the subwoofer channel when reproducing discrete signals.

When using a subwoofer, connect the SUBWOOFER terminal of this unit to the INPUT terminal of the subwoofer amplifier, and connect the speaker terminals of the subwoofer amplifier to the subwoofer.

With some subwoofers, including the Yamaha Active Servo Processing Subwoofer System, the amplifier and subwoofer are in the same unit. Such a subwoofer needs only the connection between the SUBWOOFER terminal of this unit and the INPUT terminal of the subwoofer.

(Refer to page 22 for details about the SUBWOOFER terminal.)

**IMPEDANCE SELECTOR switch**

**WARNING**

**Do not change the IMPEDANCE SELECTOR switch setting while the power to this unit is on, otherwise this unit may be damaged.**

If this unit fails to turn on when the **STANDBY/ON** switch is pressed:

The **IMPEDANCE SELECTOR** switch may not be set to either end. If so, set the switch to either end when this unit is in the standby mode.

**IMPEDANCE SELECTOR**

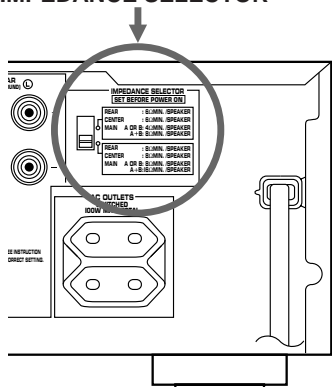

(Europe model)

Select the position whose requirements your speaker system meets.



(Upper position)

**Rear:** The impedance of each speaker must be 6Ω or higher.

**Center:** The impedance of the speaker must be 6Ω or higher.

**Main:** If you use one pair of main speakers, the impedance of each speaker must be 4Ω or higher.  
If you use two pairs of main speakers, the impedance of each speaker must be 8Ω or higher.



(Lower position)

**Rear:** The impedance of each speaker must be 8Ω or higher.

**Center:** The impedance of the speaker must be 8Ω or higher.

**Main:** If you use one pair of main speakers, the impedance of each speaker must be 8Ω or higher.  
If you use two pairs of main speakers, the impedance of each speaker must be 16Ω or higher.

## ■ To drive main, center and/or rear speakers with external amplifiers

The speaker connections described on page 20 are fine for most applications. If for some reason, however, you wish to drive main, center and/or rear speakers with your existing amplifier, etc., the following terminals are available for connecting external amplifier(s) to this unit.

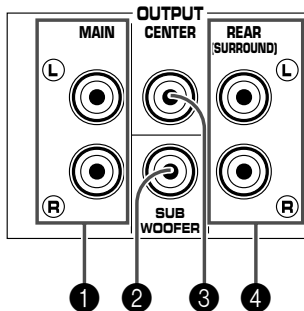

### 1 MAIN terminals

These terminals are for main channel line output. If you drive main speakers with an external stereo power amplifier, connect the input terminals of the external amplifier (MAIN IN or AUX terminals of an amplifier or a receiver) to these terminals. There is no connection to these terminals when you use the built-in amplifier.

\* Output signals from the MAIN terminals are affected by the use of **BASS**, **TREBLE**, **BALANCE** controls, **BASS EXTENSION** button and the **TONE BYPASS** button.

### 2 SUBWOOFER terminal

When using a subwoofer, connect its amplifier input to this terminal. Low frequencies distributed from the main, center and/or rear channels are output from this terminal. (The cut-off frequency of this terminal is 90 Hz.) Signals of LFE (low frequency effect) generated when Dolby Digital or DTS is decoded are also output if they are assigned to this terminal.

### 3 CENTER terminal

This terminal is for center channel line output.

If you drive a center speaker with an external power amplifier, connect the input terminal of the external amplifier to this terminal.

There is no connection to this terminal when you use the built-in amplifier.

### 4 REAR (SURROUND) terminals

These terminals are for rear channel line output.

If you drive rear speakers with an external stereo power amplifier, connect the input terminals of the external amplifier (MAIN IN or AUX terminals of an amplifier or a receiver) to these terminals.

There is no connection to these terminals when you use the built-in amplifier.

#### Notes

- Output level of signals from all of these terminals are adjusted by the use of **VOLUME** control on the front panel or **VOLUME** keys on the remote controller.
- If an external power amplifier is connected to the MAIN, CENTER, or REAR output terminals, do not use the corresponding **SPEAKERS** terminals (MAIN, CENTER, or REAR).



## Antennas

- Each antenna should be connected to the designated terminals correctly, as shown in the following figure.
- Both AM and FM indoor antennas are included with this unit. In general, these antennas will probably provide sufficient signal strength. Nevertheless, a properly installed outdoor antenna will give clearer reception than an indoor one. If you experience poor reception quality only with the indoor antennas, the use of an outdoor antenna may result in improvement.

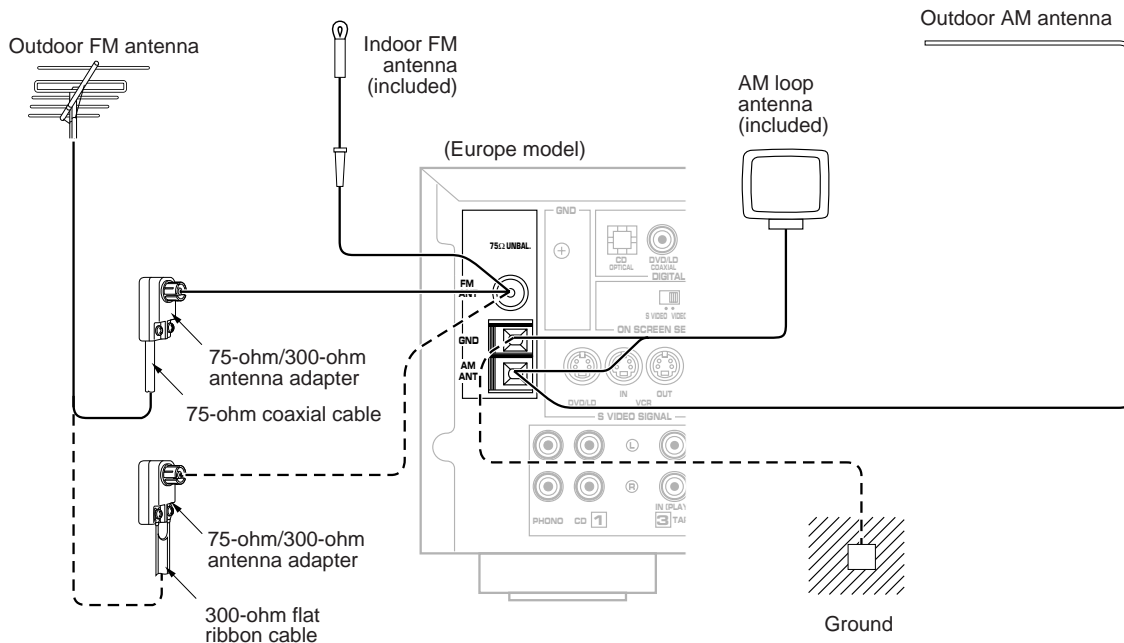

### ■ Connecting the AM loop antenna

1. Press the tab and unlock the terminal hole.
2. Connect the AM loop antenna lead wires to the AM ANT and GND terminals.
3. Return the tab back to the original position to lock the lead wires. Lightly pull on the lead wires to confirm a good connection.

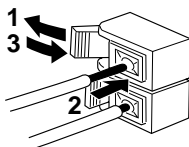

4. Attach the loop antenna to the antenna stand.

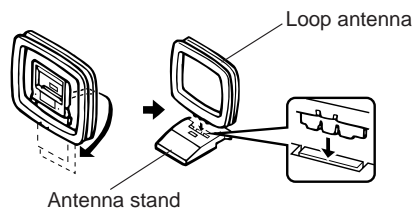

5. Orient the AM loop antenna so that the best reception is obtained.

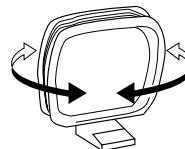

#### Notes

- The AM loop antenna should be placed apart from the main unit. The antenna may be hung on a wall.
- The AM loop antenna should be kept connected, even if an outdoor AM antenna is connected to this unit.

## ■ Connecting the indoor FM antenna

Connect the included indoor antenna to the 75Ω UNBAL. FM ANT terminal.

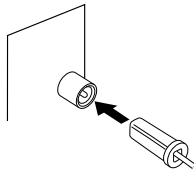

**Note**

Do not use an outdoor FM antenna and the indoor FM antenna at the same time.

**GND terminal**

For maximum safety and minimum interference, connect the **GND** terminal to a good ground. A good ground is a metal stake driven into moist earth.

## ■ Optional outdoor AM antenna

If this unit is placed in steel buildings or an area far from broadcasting stations, it may be necessary to install an outside long wire antenna.

## ■ Optional outdoor FM antenna

Consult your dealer or authorized service center about the best method of selecting and erecting an outdoor FM antenna. The choice of the flat ribbon cable is also important. Flat ribbon cable performs well electrically, and is cheaper and somewhat easier to handle when routing it through windows and around rooms. Coaxial cable is more expensive, does a much better job of minimizing interference, is less prone to the effects of weather and close-by metal objects, and is nearly as good a signal conductor as flat ribbon cable. Coaxial cable is somewhat more difficult to install at the point where the cable enters the building. If coaxial cable is selected, make sure the antenna is designed to be used with this type of cable.

\* Use a 75-ohm/300-ohm antenna adapter (not included) or a 75-ohm antenna adapter (not included) for connections.

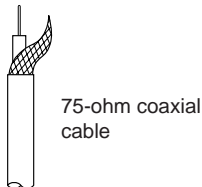
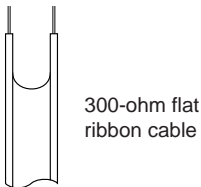
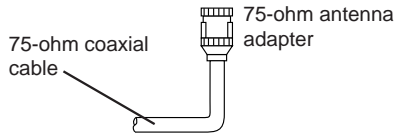
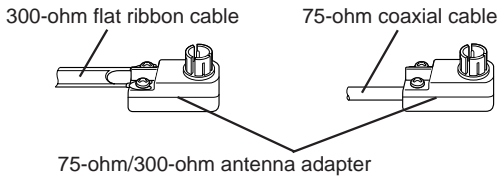

**Notes for FM antenna installation**

- To minimize the influence of automobile ignition noise, locate the antenna as far from heavy traffic as possible.
- Keep the flat ribbon cable or coaxial cable as short as possible. Do not bundle or roll up an excess of the cable.
- The antenna should be at least two meters (6.6 feet) from reinforced concrete walls or metal structures.

## Plugging in this unit

- After completing all connections, plug the AC power cord into an AC outlet.
- Unplug the AC power cord from the AC outlet if this unit is not to be used for a long period of time.

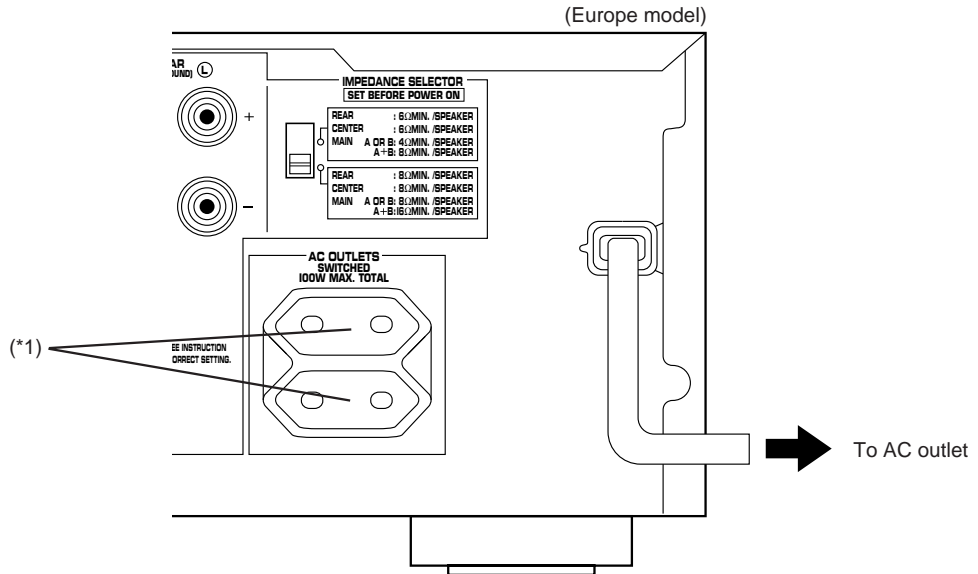

(\*1):

### AC OUTLET(S)

(Europe model)..... 2 SWITCHED OUTLETS  
 (U.K. model)..... 1 SWITCHED OUTLET

Use these to connect the power cords of your components to this unit.

The power to the **SWITCHED** outlets is controlled by this unit's **STANDBY/ON** switch or the remote controller's **POWER** and **STANDBY** keys. These outlets will supply power to any connected unit whenever this unit is turned on.

The maximum power (total power consumption of components) that can be connected to the **SWITCHED AC OUTLET(S)** is 100W.

## On screen display

If you connect your VCR, LD player, video monitor, etc. to this unit, you can take advantage of this unit's capability to display program titles, parameter data and information for various setting changes and adjustments on your video monitor screen. This information will be superimposed over the video image.

If there is no video source connected or it is turned off, the information will be displayed over a blue colored background.

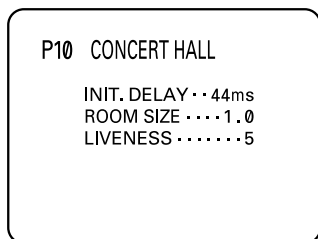

**Note:** The program titles, parameter data and other information are also displayed on the display panel of this unit.

## Selecting a type of display

You can change the type of display showing various information on the monitor screen by pressing the **ON SCREEN** display key on the remote controller. Press this key to change the screen to a full or simple display, or no display at all.

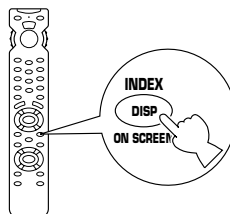

(Example)

Full display

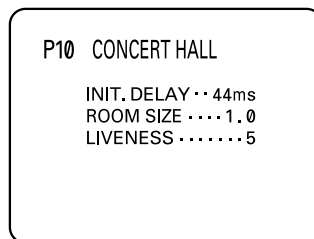

Simple display

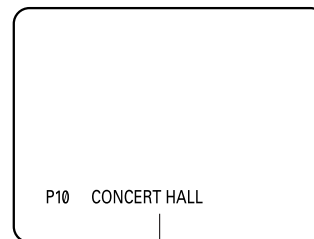

Goes off after being displayed for several seconds.

### Notes

- When making a setting change or adjustment in the SET MENU mode, or adjusting the speaker balance by using the test tone, information is fully displayed on the monitor screen even if another type of display is currently selected.
- Information displayed on the monitor screen in this way cannot be recorded by a VCR.

## Selecting the output modes (“SET MENU” mode)

The following functions control the output signals to the speakers in your audio system. When speaker connections are all completed, select a proper position on each function to maximize the performance of your speaker system.

\* For details about the SET MENU mode, refer to pages 56 to 59.

### 1. CENTER SPEAKER

### 2. REAR SPEAKER

### 3. MAIN SPEAKER

### 4. LFE/BASS OUT

### 5. MAIN LEVEL

## ■ Function description

### 1. CENTER SPEAKER

Choices: LARGE (LRG)/SMALL (SML)/NONE

Preset position: LRG

**LRG:** When your center speaker is approximately the same size as the main speakers.

**SML:** When you use a center speaker that is smaller than the main speakers.  
In this position, low bass signals (below 90 Hz) at the center channel are output from the SUBWOOFER terminals (or the main speakers if the MAIN position is selected on “4. LFE/BASS OUT”).

**NONE:** When you do not have a center speaker.  
The center channel sound will be output from the left and right main speakers.

### 2. REAR SPEAKER

Choices: LARGE/SMALL

Preset position: LARGE

**LARGE:** If your rear speakers have a high ability for bass reproduction, or a subwoofer is connected to the rear speaker in parallel.  
In this position, full range signals are output from the rear speakers.

**SMALL:** If your rear speakers do not have a high ability for bass reproduction.  
In this position, low bass signals (below 90 Hz) at the rear channels are output from the SUBWOOFER terminals (or the main speakers if the MAIN position is selected on “4. LFE/BASS OUT”).

### 3. MAIN SPEAKER

Choices: **LARGE/SMALL**  
Preset position: **LARGE**

- LARGE:** If your main speakers have a high ability for bass reproduction.  
In this position, full range signals present at the main channels are output from the main speakers.
- SMALL:** If your main speakers do not have a high ability for bass reproduction. However, if your system does not include a subwoofer, do not select this position.  
In this position, low bass signals (below 90 Hz) at the main channels are output from the SUBWOOFER terminals (if the SW or BOTH position is selected on "4. LFE/BASS OUT").

### 4. LFE/BASS OUT

Choices: **SW/MAIN/BOTH**  
Preset position: **SW**

- MAIN:** If your system does not include a subwoofer.  
In this position, full range signals present at the main channels, signals from the LFE channel and other low bass signals that are selected on "1. CENTER SPEAKER" to "3. MAIN SPEAKER" to be distributed from other channels are output from the main speakers.
- SW/BOTH:**  
Select either the SW or BOTH position if your system includes a subwoofer.  
In either position, signals at LFE channel and other low bass signals that are selected on "1. CENTER SPEAKER" to "3. MAIN SPEAKER" to be distributed from other channels are output from the SUBWOOFER terminals.  
When the LARGE position is selected on "3. MAIN SPEAKER", in the **SW** position, no signal is distributed from the main channels to the SUBWOOFER terminals, however in the **BOTH** position, low bass signals from the main channels are output to both of the main speakers and the SUBWOOFER terminals.

### 5. MAIN LEVEL

Choices: **Normal (Nrml)/-10dB**  
Preset position: **Nrml**

- Normal:** Normally, select this position.
- 10dB:** If the volume levels to the center and/or rear speakers are lower than the level to the main speakers even though they are adjusted to maximum.  
The volume level to the main speakers are decreased by 10 dB, so you can adjust the speaker output level balance properly.

#### Note

The settings of "1. CENTER SPEAKER", "2. REAR SPEAKER", "3. MAIN SPEAKER" and "4. LFE/BASS OUT" have no effect on the signals input to the EXTERNAL DECODER INPUT terminals on the rear of this unit.

# Changing selections

Refer to the display panel or the monitor screen when changing the selections.

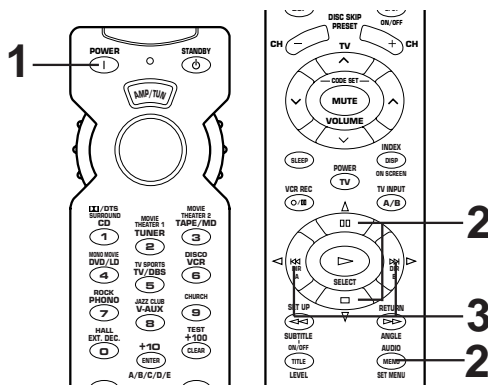
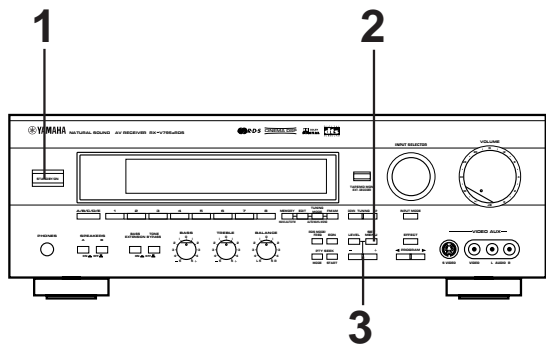

When using the remote controller, the selector dial must be set at "AMP/TUN".

Remote control

**3** Use one of the buttons figured below to select the desired position.

Front panel

Remote control

or

Changes.

**1** Turn on the power of this unit. (If necessary, turn on the power of the monitor to display information.)

Front panel

Remote control

or

**2** Select the function "1. CENTER SPEAKER" by using one of the following methods.

Front panel

Press once or more.

Remote control

Press once or more.

or

Press once.

Press once or more.

**4** Follow the same procedure for "2. REAR SPEAKER", "3. MAIN SPEAKER", "4. LFE/BASS OUT" and/or "5. MAIN LEVEL". First select the function by following step 2, and then select the proper position by following step 3.

# Speaker balance adjustment

This procedure lets you adjust the sound output level balance between the main, center and rear speakers using the built-in test tone generator. After the adjustments, the sound output level heard at the listening position will be the same from each speaker. This is important for the best performance of the digital sound field processor, the Dolby Digital decoder, the Dolby Pro Logic decoder and the DTS decoder.

The adjustment of each speaker output level should be done at your listening position with the remote controller.

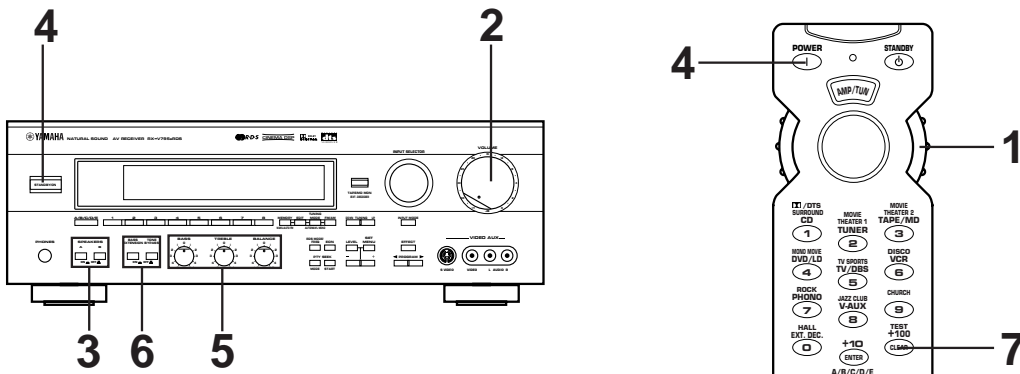

**1** Set the selector dial of the remote controller to "AMP/TUN".

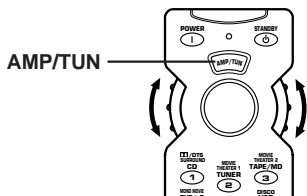

**2** Front panel

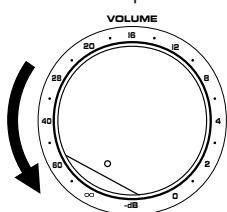

Set to the "∞" position.

**3** Select main speakers A or B.

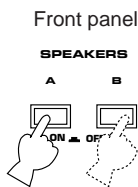

\* Both speakers A and B can be selected.

**4** Turn on the power.

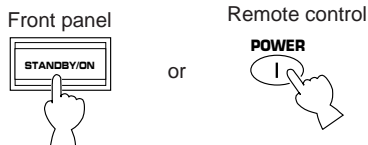

**5** Front panel

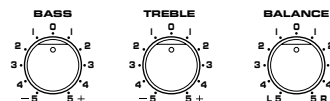

Set to the "0" position.

**6** Front panel

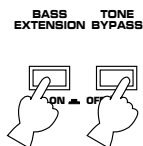

Set to the "OFF (⬇️)" position.

**7** Press the TEST key on the remote controller to enter the test mode.

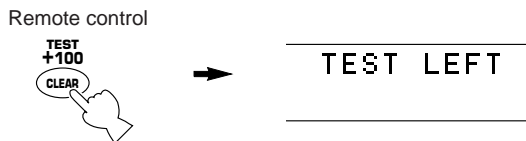

**CONTINUED**



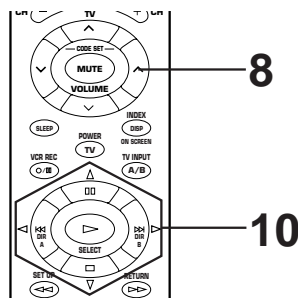
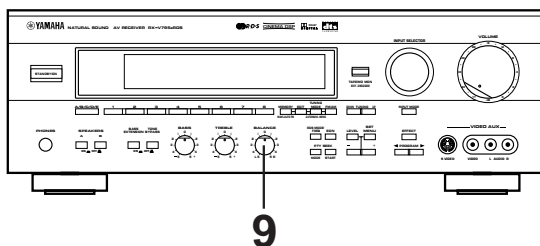

**8** Turn up the volume.

Remote control

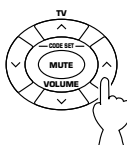

You will hear a test tone (like pink noise) from the left main speaker, then the center speaker, then the right main speaker, then the right rear speaker, and then the left rear speaker, for about 2.5 seconds each. The display changes as shown below.

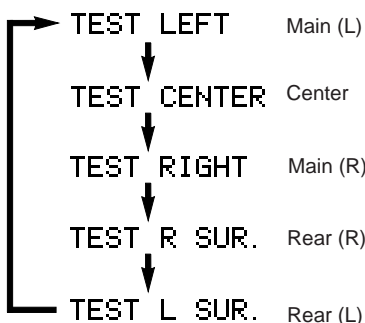

\* The state of the test tone output is also shown on the monitor screen by an image of the audio listening room. This is convenient for adjusting each speaker level.

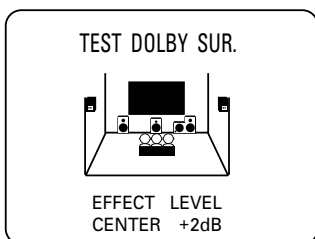

\* If the function "1. CENTER SPEAKER" in the SET MENU mode is set in the "NONE" position, you will hear the center channel test tone from the left and right main speakers.

**9** Adjust the **BALANCE** control so that the effect sound output level of the left main speaker and the right main speaker are the same.

Front panel



**10** Adjust the sound output levels of the center speaker and the rear speakers so that they become almost the same as the main speakers.

**How to adjust:**

Pressing the  $\triangleright$  or  $\triangleleft$  key adjusts the level to the speaker (except the main speakers) currently outputting the test tone.

- \* Pressing the  $\triangleright$  key raises and the  $\triangleleft$  key lowers the level.
- \* While adjusting, the test tone is fixed on the selected speaker.

Remote control

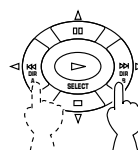

If desired, you can select a speaker to output the test tone by pressing the  $\Delta$  or  $\nabla$  key once or more so that "CENTER", "R SUR." or "L SUR." appears on the display.

- \* While holding the  $\Delta$  or  $\nabla$  key pressed, the test tone is fixed on the selected speaker.
- \* "CENTER" shows the center speaker is selected, "R SUR." shows the right rear speaker, and "L SUR." shows the left rear speaker.
- \* The output level of the selected speaker can be adjusted by the  $\triangleright$  or  $\triangleleft$  key.

Remote control

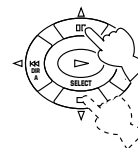

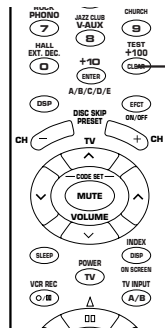

11

11

When the adjustment is finished, press the **TEST** key once again to cancel the test tone.

Remote control

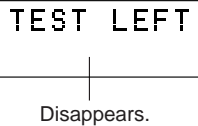

**Notes**

- Once you have completed these adjustments, you can adjust the sound level on your audio system by using the **VOLUME** control (or the **VOLUME** keys on the remote controller) only.
- If you use external power amplifiers, you may also use their volume controls to obtain proper balance.
- If the function "1. CENTER SPEAKER" in the SET MENU mode is set in the "NONE" position, in step 10, the sound output level of the center speaker cannot be adjusted. This is because in this mode, the center sound is automatically output from the left and right main speakers.
- If there is insufficient sound output from the center and rear speakers, you may decrease the main speaker output level by setting the function "5. MAIN LEVEL" in the SET MENU mode in the "-10dB" position.

## Playing a source

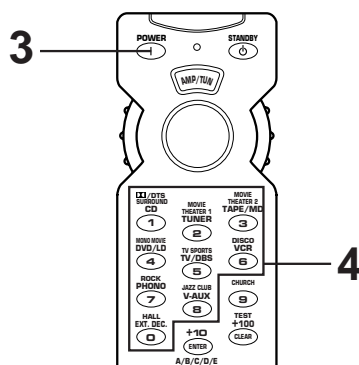
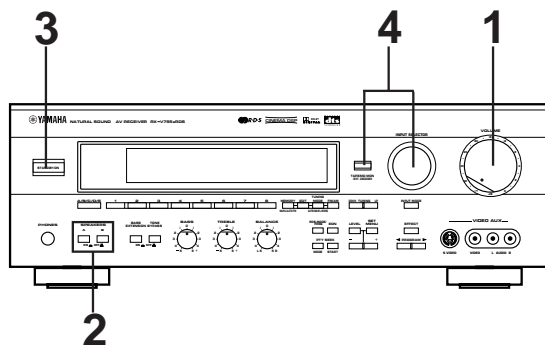

When using the remote controller, the selector dial must be set at "AMP/TUN".

Remote control

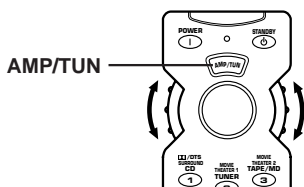

**3** Turn on the power.

Front panel

Remote control

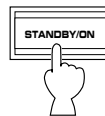

or



**4** Select an input source.

(For video sources, turn on the TV/monitor.)

The selected source is shown on the display panel and the monitor screen.

Front panel

Remote control

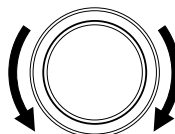

or

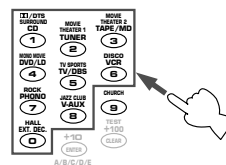

**1**

Front panel

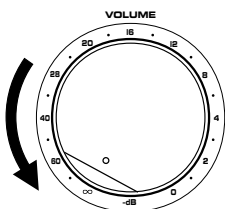

Set to the "∞" position.

**2**

Select main speakers A or B.

Front panel

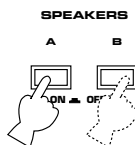

\* Both speakers A and B can be selected.



Name of the selected input source

To select the tape deck connected to this unit's TAPE/MD terminals or the source connected to this unit's EXTERNAL DECODER INPUT terminals, use one of the buttons figured below. (Refer to page 35 for details.)

Front panel



Remote control

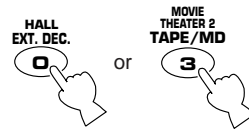

CONTINUED

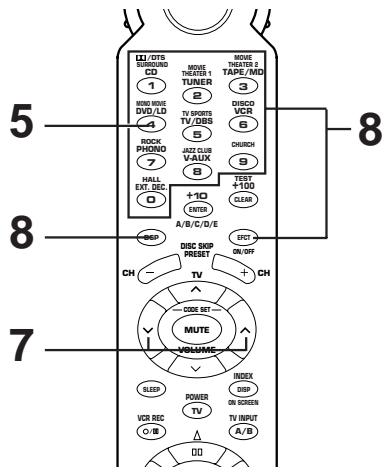
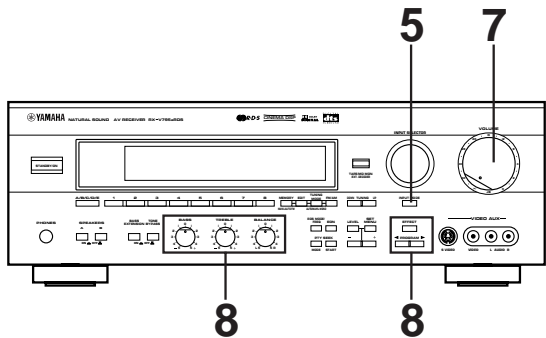

**5** The current input mode is also shown for a source that inputs two or more types of signals to this unit.

To change the input mode, press the **INPUT MODE** button on the front panel or the input selector key for the currently selected source on the remote controller. (Refer to page 36 for details on switching the input mode.)

Front panel

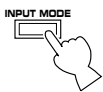

or

Remote control



Input mode

**6** Play the source. (Refer to page 39 for details on tuning.)

**7**

Front panel

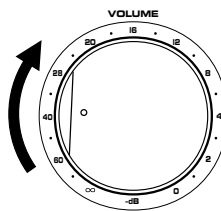

Remote control

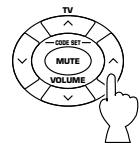

or

Adjust the output level.

**8**

Adjust the **BASS**, **TREBLE**, **BALANCE** controls, etc. (refer to page 38) and use the digital sound field processor. (Refer to pages 48 to 50.)

### When you finish using this unit

Press the **STANDBY/ON** switch on the front panel or the **STANDBY** key on the remote controller to enter the standby mode.

Front panel



or

Remote control



**To select the tape deck connected to this unit's TAPE/MD terminals or the source connected to this unit's EXTERNAL DECODER INPUT terminals as the input source.**

Use one of the buttons figured below to make the corresponding indicator illuminated on the display.

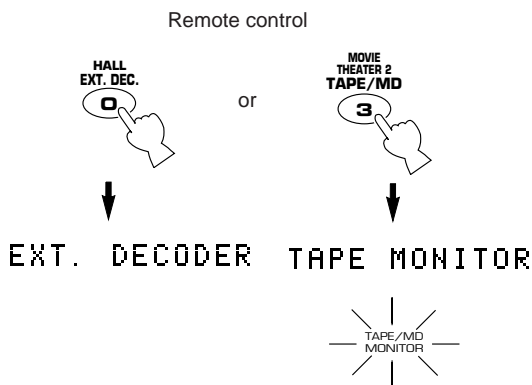
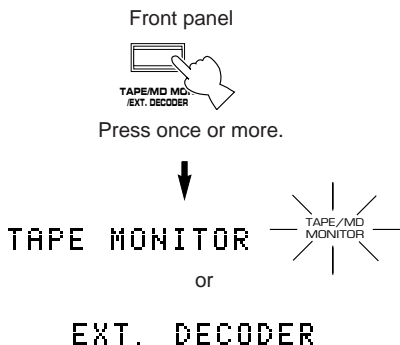

- “TAPE MONITOR”:  
Lights up for a few seconds just after you select the tape deck connected to the TAPE/MD terminals.
- “EXT. DECODER”:  
Lights up when the source connected to the EXTERNAL DECODER INPUT terminals is selected.

**Note**  
The input source selected in this way has priority over any other input source already selected. To select another input source, cancel both of the sources connected to the TAPE/MD and EXTERNAL DECODER INPUT terminals.

**To cancel both of the sources connected to the TAPE/MD and EXTERNAL DECODER INPUT terminals.**

Use one of the buttons figured above to make neither “EXT. DECODER” nor “TAPE/MD MONITOR” are illuminated on the display.

**Notes on input source selection**

- Note that selecting an input source means that the source which is connected to the corresponding input terminals on the rear panel is selected.
  - \* To select the source connected to the VIDEO AUX terminals on the front panel, select “V-AUX”.
- If you select a video input source without canceling the source already selected in the way described on the left, you will see the picture of the video input source and hear the sound of the source already selected.
- If a different audio source is selected with the input selector keys on the remote controller while enjoying a video source, the sound from the newly selected audio source is heard, but the picture from the video source can still be seen.
- When you select an input source, the DSP program (or the state of no DSP program is used) which was used when the same input source was last selected will be automatically recalled.
- If a nonstandardized source is played back, or the unit playing back a source is not operating correctly, “INPUT DATA ERR” appears on the display.

## ■ Switching the input mode for the CD, DVD/LD and TV/DBS sources

This unit allows you to switch the input mode for sources that send two or more types of signals to this unit. The following three input modes are provided.

### AUTO

This mode is automatically selected when you turn on the power of this unit.

In this mode, input signal is automatically selected by the following order of priority.

1. Digital signal encoded with Dolby Digital or DTS, or normal digital input signals (PCM)
2. Analog input signal (ANALOG)

\* For a DVD/LD source, if digital signals are input from both of the OPTICAL and COAXIAL terminals, the digital signal from the COAXIAL terminal is selected.

### DTS

In this mode, only digital input signals encoded with DTS is selected even though other signals are input at the same time.

### ANALOG

In this mode, only analog input signals are selected even though digital signals are input at the same time.

Select this mode when you want to use analog input signals instead of digital input signals.

### Notes on input mode selection

- The input mode for a TV/DBS source is selected with function "12. TV/DBS INPUT" in the SET MENU mode. This unit will be automatically set to the selected input mode when the power is turned on.
- Set the input mode to the AUTO mode to play a DVD/LD source encoded with Dolby Digital.
- Select the ANALOG mode to play a normal 2-channel source with Dolby Surround decoded.
- The sound output may be interrupted in some LD and DVD players in the following situation:  
The input mode is set to AUTO. A search is made while playing the disc encoded with Dolby Digital or DTS, then disc playing is restored. The sound output is interrupted for a moment because the digital input signal was selected again.
- The input mode cannot be changed for PHONO, TUNER, TAPE/MD, VCR and VIDEO AUX sources because only analog signals are used.
- The present input mode appears on the front display and monitor screen when the input source is changed to DVD/LD, CD or TV/DBS, or the input mode is changed. The present input signal is also shown on the monitor screen when the input mode is changed to AUTO, as shown below.

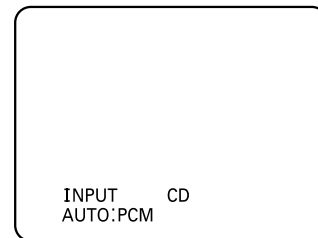

\* However, the present input signal will not be shown when the input mode is switched during the speaker test mode. Only AUTO will be displayed.

### Notes on playing a source encoded with DTS

- Select the DTS mode when playing an LD or CD source encoded with DTS. (Red "dts" indicator is illuminated on the display panel.) If the "AUTO" mode is selected, a noise may be heard just after playback begins. Do not play these sources in the ANALOG mode because only background noise will be output from the speakers.
- This unit is automatically locked in the DTS decoding mode when playing a CD or LD source encoded with DTS in the AUTO mode to prevent background noise in future operation. The red "dts" indicator will be flashing. In this mode, no sound will be heard if a disc with normal digital signals (PCM) is played from a CD or LD source. To play back the disc normally, press the **INPUT MODE** button on the front panel, or, the input selector key for the current source on the remote controller.

# Recording a source to tape (or MD) or dubbing from tape (or MD) to tape (or MD)

## Recording the playing source to tape (or MD)

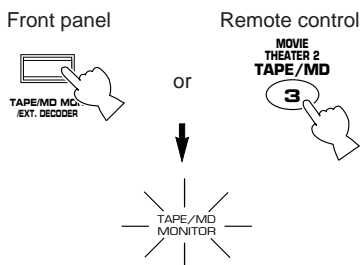
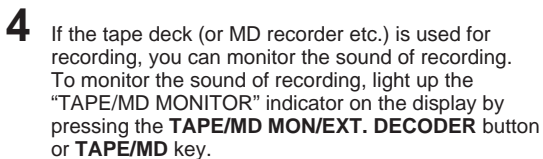
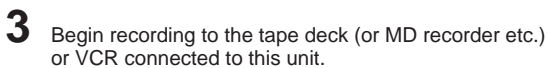
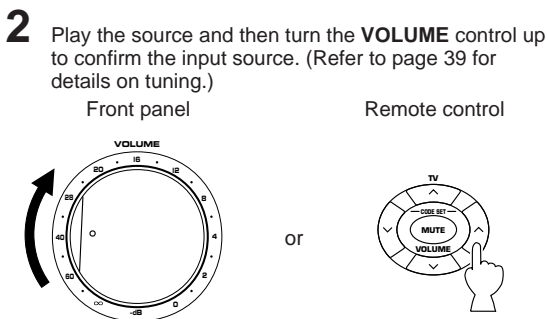
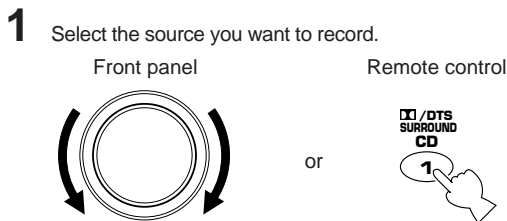
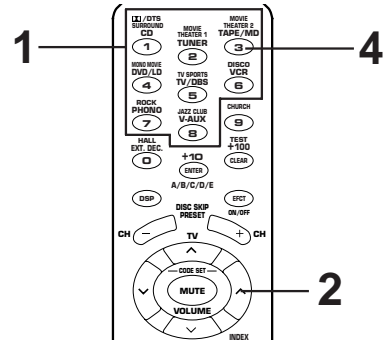
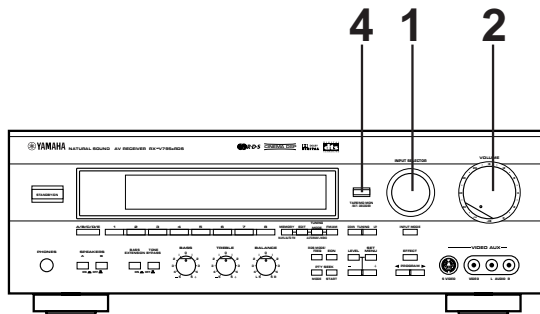

### Notes on recording

- The **VOLUME**, **BASS**, **TREBLE**, **BALANCE** controls, the **BASS EXTENSION** button and the settings of DSP have no effect on the material being recorded.
- Turn off the "TAPE/MD MONITOR" indicator when the recording is finished by pressing the **TAPE/MD MON/EXT. DECODER** button once or more. Also, do not make "EXT. DECODER" appear on the display.
- Composite video and S video signals pass independently through this unit's video circuits. Therefore, when recording or dubbing video signals, if your video source unit is connected to provide only a S video (or only a composite video) signal, you can record only a S video (or only a composite video) signal on your VCR.
- A source that is connected to this unit between optical or coaxial digital terminals only cannot be recorded by a tape deck or VCR connected to this unit.
- A source of signals input to the EXTERNAL DECODER INPUT terminals of this unit cannot be recorded.
- Please check the copyright laws in your country to record from records, compact discs, radio, etc. Recording of copyright material may infringe on copyright laws.

If you play back a video source that uses scramble or encoded signals to prevent it from being dubbed, there may be a case that display information superimposed on the picture and/or the picture itself is disturbed due to those signals.

## Sound control

### ■ Adjusting the BALANCE control

Adjust the balance of the output volume to the left and right speakers to compensate for sound imbalance caused by speaker location or listening room conditions.



**Note**

This control is effective only for the sound from the main speakers.

### ■ Using the BASS EXTENSION button

Press this button inward (ON) to boost the bass frequency response at the main left and right channels while maintaining overall tonal balance. This function is effective for reinforcing the bass frequencies when a subwoofer is not used.

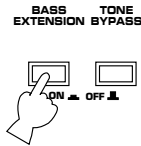

### ■ Adjusting the BASS and TREBLE controls

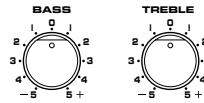

**BASS** : Turn this knob clockwise to increase (or counter-clockwise to decrease) the low frequency response.

**TREBLE** : Turn this knob clockwise to increase (or counter-clockwise to decrease) the high frequency response.

**Note**

These controls are effective only for the sound from the main speakers.

### ■ Using the TONE BYPASS button

Press this button inward (ON) to bypass the tone (**BASS** and **TREBLE**) control circuitry. This function is used for outputting pure sound and checking the tone control settings. The tone control circuitry can be used when this button is released outward (OFF).

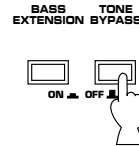



# Tuning

## Basic operation

Quick automatic-search tuning (automatic tuning) is effective when the station signals are strong with no interference. However, manual tuning can be used during less-than-ideal conditions.

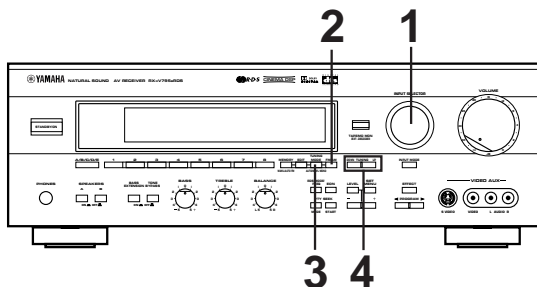

### Automatic tuning

- 1** Select "TUNER" as the input source.
- 2** Select the reception band. "FM" or "AM" will be illuminated.
- 3** Turn the "AUTO" indicator off.
- 4** Press the "UP" side once to tune in to a higher frequency. Press the "DOWN" side once to tune in to a lower frequency.

\* Press the button again if the tuning search does not stop at the correct station.  
 \* Use manual tuning if the tuning search does not stop at the correct station because the signals are weak.

### Manual tuning

- 1** Select "TUNER" as the input source.
- 2** Select the reception band. "FM" or "AM" will be illuminated.
- 3** Turn the "AUTO" indicator off.
- 4** Tune to the desired station manually.

\* Hold down the button to continue the tuning search.

#### Notes

- Manually selecting an FM station will automatically change the reception to monaural to increase the signal quality.
- When tuned in to a station, the frequency of the received station is shown on the display. If an RDS station that employs PS data service is received, the frequency is then replaced by the station name. Refer to page 45 for details.

## Preset tuning

### Manual preset tuning

This unit can store station frequencies selected by the tuning operation. With this function, you can recall any desired station only by selecting the preset station number. Up to 40 stations (8 stations x 5 groups) can be stored.

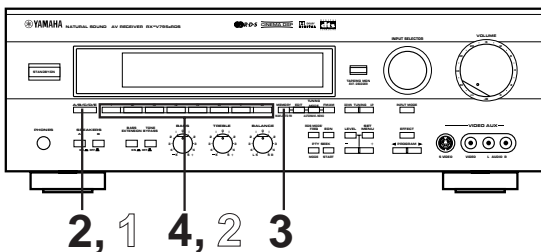

Select "AMP/TUN"

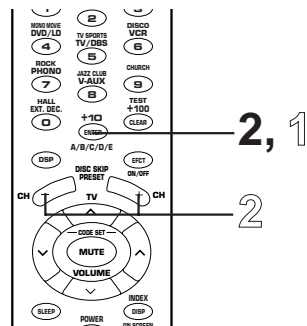
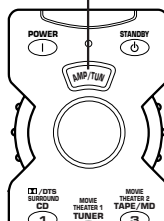

### To store stations

**1** Tune to a station.  
(Refer to the previous page for the tuning procedure.)

**2** Select a group (A – E) of preset stations.

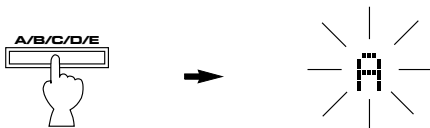

**3** Select a preset station number (1 to 8) where you want to program the station before the "MEMORY" indicator goes off from the display.  
Flashes on and off for about 5 seconds.



**4** Select a preset station number (1 to 8) where you want to program the station before the "MEMORY" indicator goes off from the display.

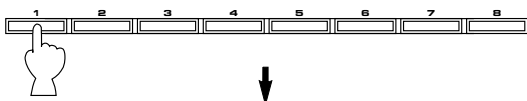

Shows the displayed station has been programmed to A1.

- \* In the same way, program other stations to A2, A3 ... A8.
- \* You can program more stations to the preset station numbers on other groups in the same way by selecting other groups in step 2.

### To recall a preset station

**1** Select the group of preset stations.

Front panel



Remote control

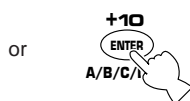

**2** Select the preset station number.

Front panel

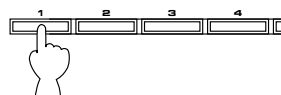

Remote control



### Notes

- A new setting can be programmed in place of the former one.
- For presets, the setting of the reception mode (stereo or monaural) is stored along with the station frequency.

### Memory back-up

The memory back-up circuit prevents the programmed data from being lost even if this unit is set to the standby mode or the power plug is disconnected from the AC outlet or the power is cut due to a temporary power failure. If, however, the power is cut for more than one week, the memory may be deleted. If so, it can be re-programmed by simply following the Preset tuning steps.

## Automatic preset tuning

You can make use of an automatic preset tuning function for RDS stations. With this function, this unit performs automatic tuning and stores RDS stations with strong signals sequentially. Up to 40 stations are stored automatically in the same way as in the manual preset tuning method on page 40.

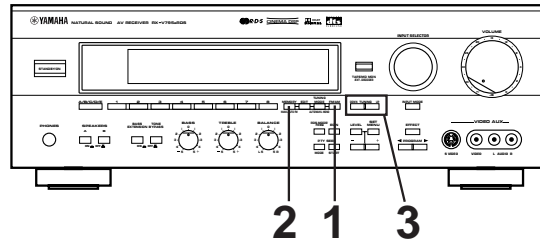

### To store stations

**1**

**2** Press and hold for more than 3 seconds

Flashes.

**3**

To tune to higher frequencies, press the "UP" side once.  
To tune to lower frequencies, press the "DOWN" side once.  
\* If the **TUNING** button is not pressed, in a while, the automatic preset tuning begins automatically toward higher frequencies.

The automatic preset tuning begins from the frequency currently displayed. Received stations are programmed to A1, A2 ... A8 sequentially.  
\* If more than 8 stations are received, they are also programmed to the preset station numbers on other groups (B, C, D and E) in that order.

### If you want to store the first received station to the desired preset station number.

If, for example, you want to store the first received station to C5, select "C5" by using the **A/B/C/D/E** button and the preset station number selector buttons after pressing the **MEMORY** button in step 2. Then press the **TUNING** button. The first received station is stored to C5, and next stations to C6, C7 ... sequentially.

If stations are stored up to E8, the automatic preset tuning is finished automatically.

### When the automatic preset tuning is finished

The display shows the frequency of the last preset station. Check the contents and the number of preset stations by following the procedure of the section "To recall a preset station" on page 40.

### To recall a preset station

Simply follow the procedure of the section "To recall a preset station" on page 40.

A recalled station is shown by the frequency (and the station name if the station employs PS data service) on the display.

### Notes

- You can replace a preset station by another FM or AM station manually by simply following the procedure of the section "To store stations" on page 40.
- The automatic preset tuning search will be performed through all RDS network frequencies until stations are stored up to E8. If the number of received stations is not enough to be stored up to E8, the search is finished automatically after searching all frequencies.
- With this function, only RDS stations with sufficient signal strength are stored automatically. If the station you want to program is weak in signal strength, tune to it in monaural manually and program it by following the procedure of the section "To store stations" on page 40.  
\* There may be a case that this function cannot receive a station which could be received by the automatic tuning method. This is because this function receives a large volume of PI (Program Identification) data along with the station.

## ■ Exchanging preset stations

You can exchange the places of two preset stations with each other as shown below.

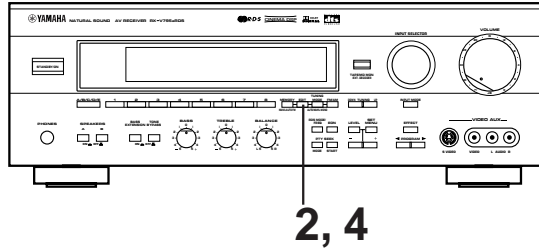

2, 4

### Example)

If you want to exchange the preset stations on E1 and A5 with each other.

**1** Recall the preset station on E1 (by following the method of "To recall a preset station" on page 40).

**2**

→



Flashes.

**3** Recall the preset station on A5 by following the same method with step 1.



Flashes.

**4**



↓

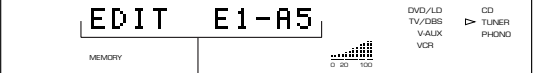

Shows the exchange of stations is completed.

In areas where RDS broadcasts cannot be received, the RDS broadcast functions do not operate. (Skip the procedures from pages 43 to 47.)

## Receiving RDS stations

RDS (Radio Data System) is a data transmission system gradually being introduced by FM stations in many countries. Stations using this system transmit an inaudible stream of data in addition to the normal radio signal.

RDS data contains various information, such as PI (Program Identification), PS (Program Service name), PTY (Program Type), RT (Radio Text), CT (Clock Time), EON (Enhanced Other Networks), etc.

RDS function is carried out among the network stations.

\* This unit utilizes PI, PS, PTY, RT, CT and EON to receive RDS broadcast stations.

## Displaying RDS data

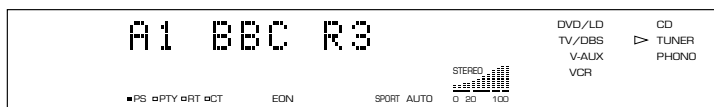

The following five modes are available in this unit for displaying RDS data.

### PS (Program Service name) mode:

Displays the name of the RDS station now being received instead of the frequency.

### PTY (Program Type) mode:

Displays the type of the program on the RDS station now being received. There are 15 program types for classifying RDS stations. Refer to the next page for details.

### RT (Radio Text) mode:

Displays information about the program (such as the title of the song, name of the singer, etc.) on the RDS station now being received.

### CT (Clock Time) mode:

Displays the current time. This signal comes from the RDS station now being received.

### EON (Enhanced Other Networks) mode:

Select a program type with the **EON** button. The unit will automatically change to a station that starts to broadcast that type of program. When the program is finished, the unit will return to the original program.

## ■ Program types in the PTY mode

- NEWS** **News:**  
Short accounts of facts, events and publicly expressed views, reportage and actuality.
- AFFAIRS** **Current affairs:**  
Topical program expanding or enlarging upon the news, generally in different presentation style or concept, including documentary debate, or analysis.
- INFO** **Information:**  
Program whose purpose is to impart advice in the widest sense, including meteorological reports and forecasts, consumer affairs, medical help, etc.
- SPORT** **Sport:**  
Program concerned with any aspect of sport.
- EDUCATE** **Education:**  
Program intended primarily to educate, of which the formal element is fundamental.
- DRAMA** **Drama:**  
All radio plays and serials.
- CULTURE** **Culture:**  
Programs concerned with any aspect of national or regional culture, including religious affairs, philosophy, social science, language, theatre, etc.
- SCIENCE** **Science:**  
Programs about the natural sciences and technology.
- VARIED** **Varied:**  
Used for mainly speech-based programs usually of light-entertainment nature, not covered by above categories. Examples are: quizzes, panel games, personality interviews, comedy and satire.
- POP M** **Pop:**  
Commercial music, which would generally be considered to be of current popular appeal, often featuring in current or recent record sales charts.
- ROCK M** **Rock:**  
Contemporary modern music, usually written and performed by young musicians.
- M.O.R. M** **M.O.R.:**  
(Middle of the Road Music). Common term to describe music considered to be "easy-listening", as opposed to Pop, Rock or Classical. Music in this category is often but not always, vocal, and usually of short duration (<5 min.)
- LIGHT M** **Light classics:**  
Classical Musical for general, rather than specialist appreciation. Examples of music in this category are instrumental music, and vocal or choral works.
- CLASSICS** **Serious classics:**  
Performances of major orchestral works, symphonies, chamber music etc., and including Grand Opera.
- OTHER M** **Other music:**  
Musical styles not fitting into any of the above categories. Particularly used for specialist music, of which Jazz, Rhythm & Blues, Folk, Country, and Reggae are examples.

## ■ Changing the RDS modes

When an RDS station is received, "PS", "PTY", "RT" and/or "CT" that correspond to the RDS data services employed by the station light up on the display. By pressing the **RDS MODE/FREQ** button once or more, you can change the display mode among the RDS modes employed by the received station in the order shown below. (The RDS mode not employed by the station cannot be selected.) Illumination of the indicator on the head of the name of an RDS mode shows that the corresponding RDS mode is now selected.

\* When an RDS station is received, do not press the **RDS MODE/FREQ** button until one or more names of RDS modes light up on the display. If the button is pressed before one or more names light up on the display, the mode cannot be changed. This is because the unit has not received all of the RDS data on the station yet.

\* If no name of RDS mode lights up on the display, the mode cannot be changed.

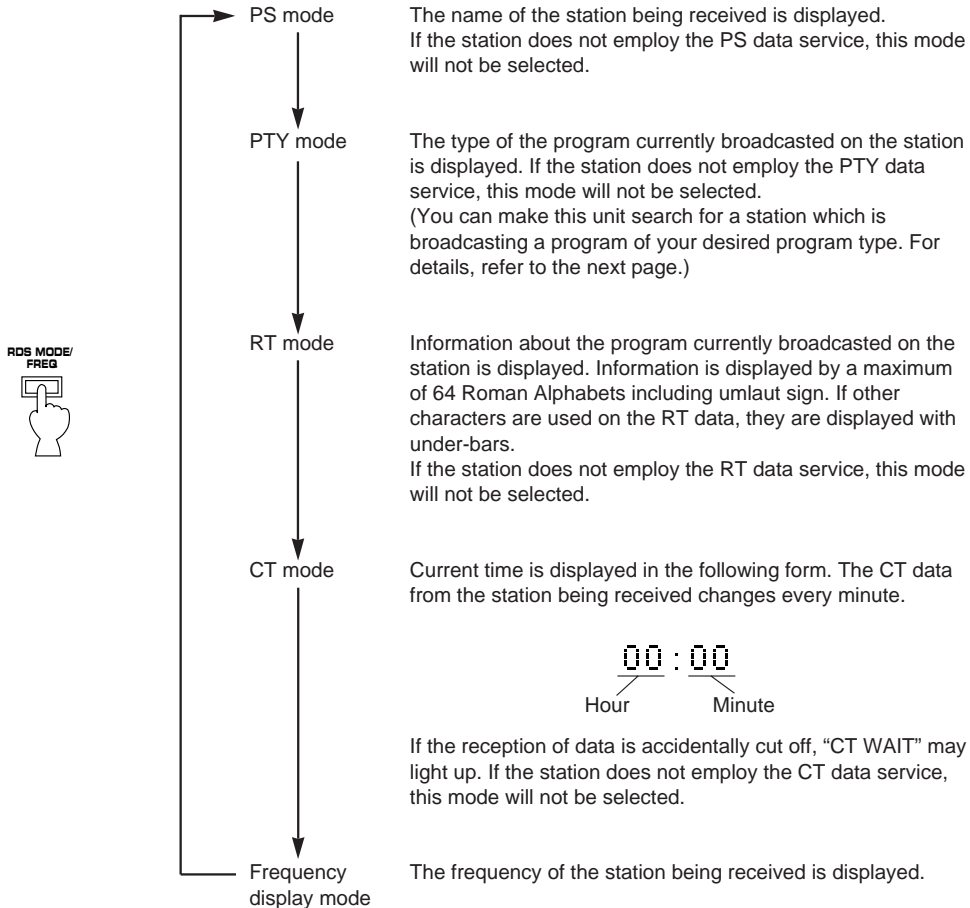

### Notes

- RDS data service cannot be utilized by this unit if the received signal is not strong enough. Especially, the RT (Radio Text mode) needs sufficient data to be received, so the RT mode may not display even if other RDS modes (PS, PTY, etc.) are displayed.
- RDS data reception may not be possible due to poor reception conditions. If so, press the **TUNING MODE** button so that the "AUTO" indicator goes off from the display. Though the reception mode is changed to monaural by this operation, when you change the display to an RDS mode, RDS data may be displayed.
- If the signal strength becomes weakened by external interference when receiving an RDS station, the RDS data service may be cut off suddenly and "...WAIT" will light up on the display.

## Selecting your desired program type from among preset RDS stations (PTY SEEK)

By designating a program type, the unit automatically searches all preset stations for an RDS station which broadcasts a program of that program type.

\* There are 15 program types for classifying RDS stations. For details, refer to page 44.

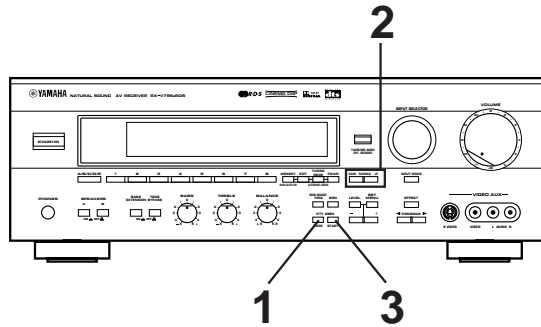

**1** Set the unit in the PTY SEEK mode.

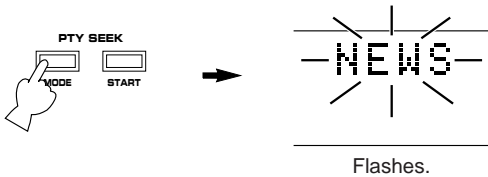

Flashes.

\* The program type of the station now being received or "NEWS" flashes on the display.

**2** Select the desired program type.

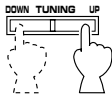

**3** Begin searching all preset RDS stations.

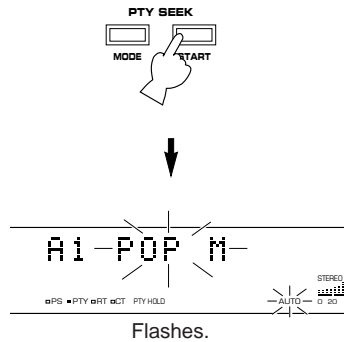

Flashes.

\* The "PTY HOLD" indicator will be illuminated on the display.

- If a station which broadcasts the program type you selected is found, the unit stops at the station and the display shows its frequency after showing the flashing name of the program type.
- If the selected station is not the desired one, press the **PTY SEEK START** button once more. The unit begins searching for another station which broadcasts the same program type.
- To stop the search, press the **PTY SEEK START** button once more.

### To cancel this function

If the **PTY SEEK MODE** button is pressed once more, the PTY SEEK mode will be canceled.



## Automatic selection of desired program when broadcasting starts

This function uses the EON (Enhanced Other Networks) data service on the RDS station network.

Only by selecting a desired program type (NEWS, INFO, AFFAIRS or SPORT), this unit automatically searches all preset RDS stations for a station that broadcasts that program type (though you cannot check the searching process), and, if found, receives a program when its broadcast starts in place of the program now being received.

\* This function can be used only when an RDS station that employs the EON data service is received. (When such a station is received, the "EON" indicator will be illuminated on the display.)

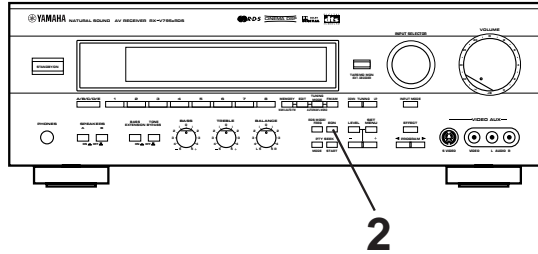

- 1** Make sure that the "EON" indicator is illuminated on the display.



\* If the "EON" indicator is not illuminated on the display, receive an (or another) RDS station so that the "EON" indicator will be illuminated on the display.

- 2** Select the desired program type, NEWS, INFO, AFFAIRS or SPORT.

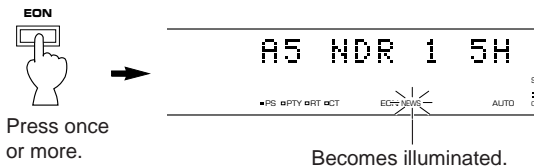

The search is performed among all preset RDS stations in the background. If a program is found, the program will be automatically received when it starts broadcasting.

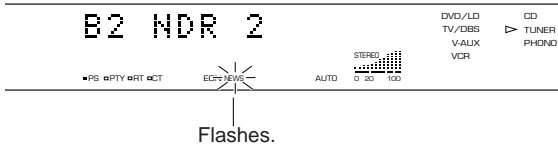

- 3** When the broadcast of the selected program ends, the previously received program (or another program of the same station) is recalled.



### To cancel this function

Press the **EON** button once or more, so that no program type name is illuminated on the display.

## Using digital sound field processor (DSP)

This unit incorporates a sophisticated, multi-program digital sound field processor. The processor allows you to electronically expand and change the shape of the audio sound field from both audio and video sources, creating a theater-like experience in your listening room. You can create an excellent audio sound field by selecting a suitable sound field program (this will, of course, depend on what you will be listening to), and adding desired adjustments.

In addition, this unit incorporates a Dolby Digital decoder and a Dolby Pro Logic decoder for multi-channel sound reproduction of sources encoded with Dolby Surround, and a DTS decoder for multi-channel sound reproduction of sources encoded with DTS. The operation of these decoders can be controlled by selecting a corresponding DSP program including a combined operation of YAMAHA DSP and the Dolby Digital, Dolby Pro Logic or DTS decoder.

This unit has 10 programs for digital sound field processing; 5 programs for Audio sources and 5 programs for Audio/Video sources. In addition, some programs have two subprograms. All programs contain parameters that can be adjusted to the listener's taste.

For details about digital sound field programs, refer to pages 53 to 55.

### Playing a source with an effect of the digital sound field processor (DSP)

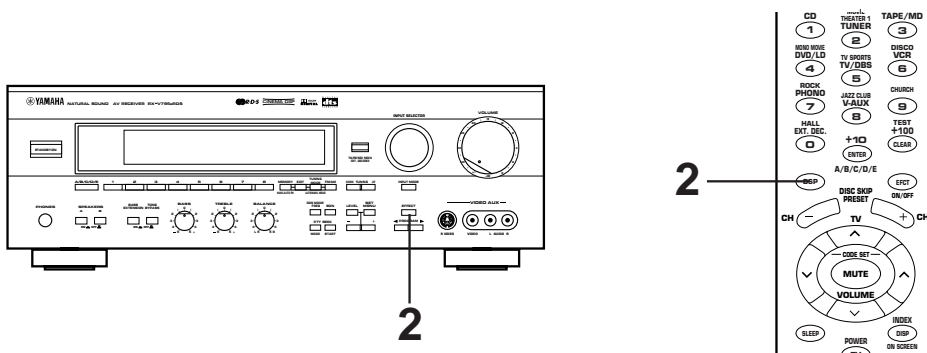

**1** Follow steps 1 to 7 shown in "Playing a source" on pages 33 to 34.

**2** When operating on the front panel:

If no program name is illuminated on the display panel, press the **EFFECT** button to turn on the digital sound field processor so that a name of a DSP program appears on the display panel and the monitor screen.



CONCERT HALL

DVD/LD  
TV/VIDEO  
V-AUX  
VCR

When operating on the remote controller:

When the selector dial is set at a position other than DSP:

The indicator lights up for about 3 seconds.

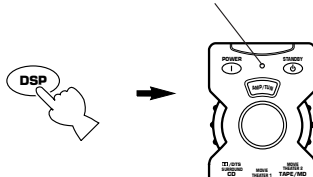

\* Do the next operation while the indicator is illuminated. If the indicator goes off before you do the next operation, press the **DSP** key again.

When the selector dial is set at DSP:

Go on to the next step.

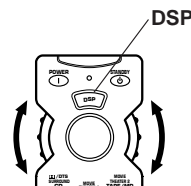

**CONTINUED**

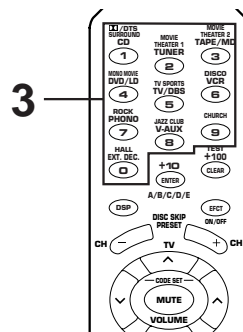
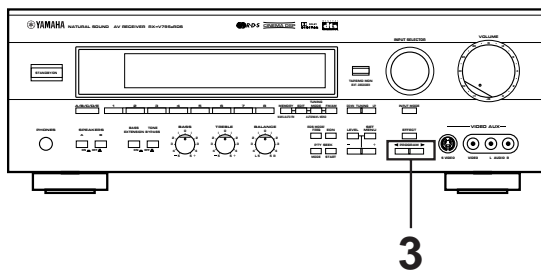

**3** Select a program that is suitable for the source.

When operating on the front panel:



Press once or more.

When operating on the remote controller:

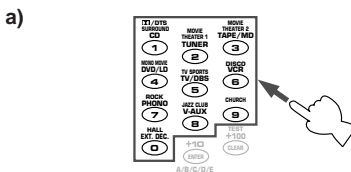

\* Press "0" to select the program No. 10.

b) For the programs No. 1, 2 and 3 only, you can select the desired subprogram by pressing the corresponding DSP program selector key once or more.

The name of the selected program appears on the display panel and the monitor screen.



Program name



Subprogram name

Program name

- 4**
- Adjust the output level of each speaker. (For details, refer to the corresponding descriptions on pages 51 and 52.)
  - You can create your own sound field taste. (For details, refer to pages 60 to 63.)

**Notes**

- Program selection can be made to individual input sources. Once you select a program, it is linked with the input source selected at this time. So, when you select the same input source the next time, the same program will be automatically recalled.
- If you prefer to cancel the DSP, press the **EFFECT** button. The sound will be the normal 2-channel stereo without surround sound effect.
- When a monaural sound source is played with the program **PRO LOGIC (Normal/Enhanced)**, a proper effect will not be obtained. Moreover, sound may become unnatural depending on the settings of the speaker output modes (1. CENTER SPEAKER to 4. LFE/BASS OUT) in the SET MENU mode.
- When this unit's Dolby Pro Logic decoder, Dolby Digital decoder or DTS decoder is used, if the main-source sound is considerably altered by overadjustment of the **BASS** or **TREBLE** control, the relationship between the center and rear channels may produce an unnatural effect.
- When a source of signals input to the EXTERNAL DECODER INPUT terminals of this unit is selected, the DSP cannot be used and the **EFFECT** button also will not function.

## ■ To enjoy a video source encoded with Dolby Surround, Dolby Digital or DTS

When you select the program No. 1, 2 or 3, and the input signal of the source is 2-channel stereo, Dolby Surround is decoded. When some program is selected and the input signal of the source is encoded with Dolby Digital, Dolby Digital is automatically decoded.

When some program is selected and the input signal of the source is encoded with DTS, DTS is automatically decoded.

The following indicators on the display panel show you what sound processing is being made.

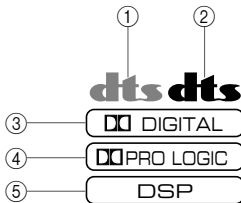

- ① Lights up when a DVD source encoded with DTS is played back and DTS is decoded.
- ② Lights up when an LD source or a CD source encoded with DTS is played back and DTS is decoded.
- ③ Lights up when Dolby Digital is being decoded and the signals of selected source encoded with Dolby Digital is not in 2-channels.
- ④ Lights up when Dolby Surround is being decoded.
- ⑤ Lights up when Digital Sound Field Processor is turned on.

The display panel or the monitor screen will show the selected subprogram according to the type of the decoding.

### Notes

- Dolby Digital will not be decoded if the source that is not encoded with Dolby Digital.  
DTS will not be decoded if the source that is not encoded with DTS.
- If the input signals of source encoded with Dolby Digital are in 2-channels only, the sound processing for them is similar to that for analog or PCM audio signals.

### Note

If you change the LD (or CD) being played back with DTS decoded to another disc not encoded with DTS when the red "dts" indicator is illuminated, playing back the newly selected disc will output no sound. In this state, the red "dts" indicator flashes to show that this unit is locked in the DTS-decoding mode.

To play back the disc normally, change the current DTS-decoding mode to another mode by pressing an input selector key on the remote controller or the **INPUT MODE** button on the front panel so that the red "dts" indicator turns off.

## ■ To cancel the effect sound

The **EFFECT** button on the front panel or the **EFCT ON/OFF** key on the remote controller make it simple to compare the normal stereo sound with the fully processed effect sound.

To cancel the effect sound and monitor only the main sound, press the **EFCT ON/OFF** key or the **EFFECT** button. Press the **EFCT ON/OFF** key or the **EFFECT** button a second time to restore the effect sound.

Front panel



Remote control



OR

### Notes

- If the effect sound is canceled when signals encoded with Dolby Digital or DTS are input to this unit, signals of all channels are mixed and are output from the main speakers.
- If the **EFFECT** button or the **EFCT ON/OFF** key is pressed to turn effect sounds off when Dolby Digital or DTS is decoded, it may happen that sound is output faintly or not output normally depending on a source. In that case, press the **EFFECT** button or the **EFCT ON/OFF** key to turn effect sounds ON, or use input signals not encoded with Dolby Digital or DTS.

## Adjusting output level of the center, right rear, left rear speakers and subwoofer

You can adjust the sound output level of the each speaker even if the output level is already set in "Speaker balance adjustment" on pages 30 to 32.

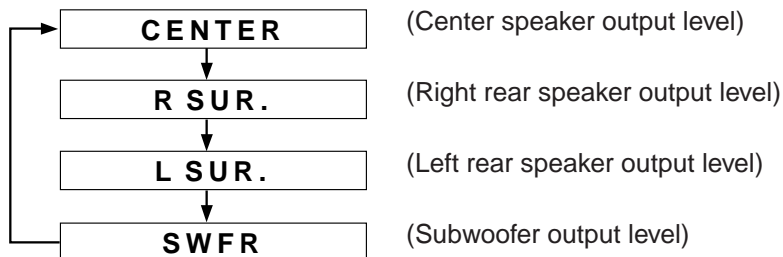

Speakers	Control range (dB)	Preset value
CENTER	MIN, -20 to +10	0
RIGHT SURROUND (R SUR.)	MIN, -20 to +10	0
LEFT SURROUND (L SUR.)	MIN, -20 to +10	0
SUBWOOFER (SWFR)	MIN, -20 to 0	0

## Method of adjustment

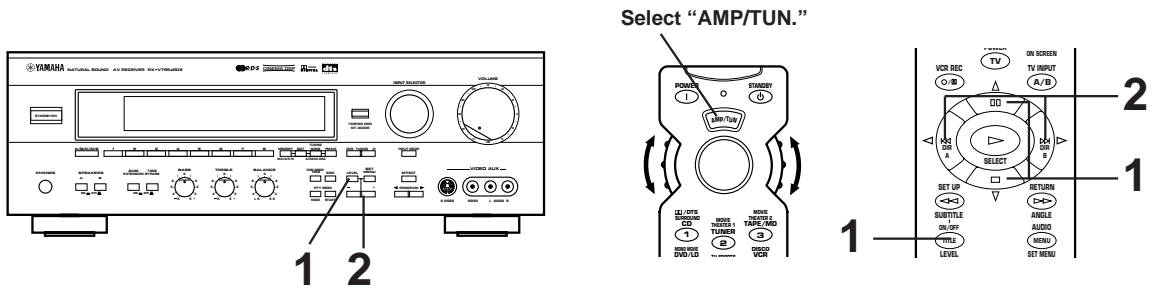

**1** Select the speaker(s) whose level you want to adjust by using one of the following methods.

**When operating on the front panel:**

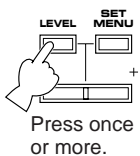

**When operating on the Remote controller:**

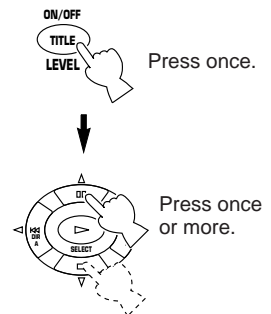

Press a button repeatedly until the name of the desired speaker(s) appears on the display.

**2** Adjust the level on the selected speaker(s).

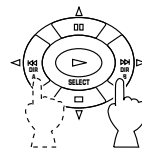
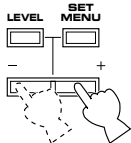

**3** Repeat steps 1 and 2 to make adjustments on the other speaker(s).

### Notes

- If the function "1. CENTER SPEAKER" in the SET MENU mode is set in the "NONE" position, the sound output level of the center speaker cannot be adjusted. This is because in this mode, the center sound is automatically output from the left and right main speakers.
- Once the output level is adjusted, the level value will be the same in all the digital sound field programs.
- The value of each speaker output level you set the last time will remain memorized even when this unit is in the standby mode. However, if the power cord is disconnected for more than one week, these values will be automatically changed to the factory default settings.

## Brief overview of digital sound field programs

The following list gives you a brief description of the sound fields produced by each of the DSP programs. Keep in mind that most of these are precise digital recreations of actual acoustic environments. The data for these sound fields were recorded at actual locations using sophisticated sound field measurement equipment.

### Note

The channel level balance between the left and right rear effect speakers may vary depending on the sound field you are listening in. This is due to the fact that most of these sound field recreations are actual acoustic environments.

## ■ Program No. 1 to 5: CINEMA-DSP programs (for Audio/Video sources)

- These programs use the Dolby Pro Logic decoder, the Dolby Digital decoder or the DTS decoder.
- Speaker output: main, center, rear  
**Note:** If the "NONE" position is selected on "1. CENTER SPEAKER" in the SET MENU mode, no sound is output from the center speaker.
- Program No. 1 is for reproducing video discs, video tapes and similar sources which are encoded with Dolby Surround (bearing the "DOLBY SURROUND" or "DOLBY DIGITAL" logo) or encoded with DTS (bearing the "dts" logo).

No.	PROGRAM	SUBPROGRAM (TYPE)	FEATURE
1	<b>Dolby/DTS SURROUND</b>	<p><b>PRO LOGIC/Normal</b> ( <input checked="" type="checkbox"/> PRO LOGIC )            Functions when the input signal is analog or PCM audio or encoded with Dolby Digital in 2 channels.</p> <p><b>DOLBY DIGITAL/Normal</b> ( <input checked="" type="checkbox"/> DIGITAL )            Functions when the input signal is encoded with Dolby Digital not in 2 channels.</p> <p><b>DTS DIGITAL SUR/Normal</b> ( <b>dts</b> )            Functions when the input signal is encoded with DTS.</p>	<p>The built-in Dolby Pro Logic decoder, the Dolby Digital decoder or the DTS decoder precisely reproduces sounds and sound effects of a source encoded with Dolby Surround or DTS. The realization of a highly efficient decoding process improves crosstalk and channel separation and makes sound positioning smoother and more precise.</p>
		<p><b>PRO LOGIC/Enhanced</b>            ( <input checked="" type="checkbox"/> PRO LOGIC <input type="checkbox"/> DSP )            Functions when the input signal is analog or PCM audio or encoded with Dolby Digital in 2 channels.</p> <p><b>DOLBY DIGITAL/Enhanced</b>            ( <input checked="" type="checkbox"/> DIGITAL <input type="checkbox"/> DSP )            Functions when the input signal is encoded with Dolby Digital not in 2 channels.</p> <p><b>DTS DIGITAL SUR/Enhanced</b>            ( <b>dts</b> <input type="checkbox"/> DSP )            Functions when the input signal is encoded with DTS.</p>	<p>Ideally simulates the multi-surround speaker systems of the newest film theater. The digital sound field processing and the Dolby Surround decoding or the DTS decoding are precisely performed without altering the originally designed sound orientation. The surround effects produced by this sound field fold the viewer naturally from the rear to the left and right and toward the screen.</p>

- Program No. 2 to 3 are suitable for reproducing video discs, video tapes and similar sources which are encoded with Dolby Surround (bearing the “DOLBY SURROUND” or “DOLBY DIGITAL” logo) or encoded with DTS (bearing the “dts” logo).

No.	PROGRAM	SUBPROGRAM (TYPE)	FEATURE
2	<b>MOVIE THEATER 1</b>	<p><b>70 mm Spectacle</b>  <input checked="" type="checkbox"/> PRO LOGIC   <input type="checkbox"/> DSP )                      Functions when the input signal is analog or PCM audio or encoded with Dolby Digital in 2 channels.</p> <p><b>DGTL Spectacle</b>  <input checked="" type="checkbox"/> DIGITAL   <input type="checkbox"/> DSP )                      Functions when the input signal is encoded with Dolby Digital not in 2 channels.</p> <p><b>DTS Spectacle</b>  <input checked="" type="checkbox"/> dts   <input type="checkbox"/> DSP )                      Functions when the input signal is encoded with DTS.</p>	<p>Creates the extremely wide sound field of a movie theater. It precisely reproduces the source sound in detail, giving both the video and the sound field incredible reality. Any kind of video sources encoded with Dolby Surround or DTS (especially large-scale movie productions) are ideal for use with this program.</p>
3	<b>MOVIE THEATER 2</b>	<p><b>70 mm Adventure</b>  <input checked="" type="checkbox"/> PRO LOGIC   <input type="checkbox"/> DSP )                      Functions when the input signal is analog or PCM audio or encoded with Dolby Digital in 2 channels.</p> <p><b>DGTL Adventure</b>  <input checked="" type="checkbox"/> DIGITAL   <input type="checkbox"/> DSP )                      Functions when the input signal is encoded with Dolby Digital not in 2 channels.</p> <p><b>DTS Adventure</b>  <input checked="" type="checkbox"/> dts   <input type="checkbox"/> DSP )                      Functions when the input signal is encoded with DTS.</p>	<p>Ideal for precisely reproducing the sound design of the newest multi-track films. The sound field is made to be similar to that of the newest movie theaters, so the reverberations of the sound field itself are restrained as much as possible. The data of the sound field of an opera house are used for the front presence side, so the three dimensional feeling of the sound field is emphasized, and dialog is precisely oriented on the screen. By using the data of the sound field of a concert hall on the rear surround side, powerful reverberations are generated. You can enjoy watching action, adventure movies, etc. with much presence.</p>
		<p><b>70 mm General</b>  <input checked="" type="checkbox"/> PRO LOGIC   <input type="checkbox"/> DSP )                      Functions when the input signal is analog or PCM audio or encoded with Dolby Digital in 2 channels.</p> <p><b>DGTL General</b>  <input checked="" type="checkbox"/> DIGITAL   <input type="checkbox"/> DSP )                      Functions when the input signal is encoded with Dolby Digital not in 2 channels.</p> <p><b>DTS General</b>  <input checked="" type="checkbox"/> dts   <input type="checkbox"/> DSP )                      Functions when the input signal is encoded with DTS.</p>	<p>This program is for reproducing sounds on a multi-track film, and characterized by a soft and extensive sound field. The front presence side of the sound field is relatively narrow. It spatially spreads all around and toward the screen, restraining echo effect of conversations without losing clarity. For the surround side, the harmony of music or chorus sounds beautifully in a wide space at the rear of the sound field.</p>



- For program No. 4 and 5 only, indicators light up as follows.

When the input signal is analog or PCM audio: (  DSP )

When the input signal is encoded with the Dolby Digital (not in 2 channels): (  DIGITAL  DSP )

When the input signal is encoded with the DTS: ( **dts**  DSP )

No.	PROGRAM	FEATURE
4	<b>MONO MOVIE</b>	This program is designed specifically to enhance mono source programs. Compared to a strictly mono setting, the sound image created in this mode is wider and slightly forward of the speaker pair, lending an immediacy to the overall sound. It is particularly effective when used with old mono movies, news broadcasts and dialog.
5	<b>TV SPORTS</b>	This program is furnished with a tight sound field in which the sound will not spread excessively on the front side, but the rear surround side produces a dynamic sound expansion. This program is the most suitable for sports programs.

## ■ Program No. 6 to 10: Hi-Fi DSP programs (for audio sources)

Speaker output: main, rear (  DSP )

No.	PROGRAM	FEATURE
6	<b>DISCO</b>	This program recreates the acoustic environment of a lively disco in the heart of a very lively city. The sound is dense and highly concentrated. It is also characterized by a high-energy, "immediate" sound.
7	<b>ROCK CONCERT</b>	This program is ideally suited for rock music. You will experience a very dynamic or lively sound field.
8	<b>JAZZ CLUB</b>	This is a small, cozy jazz club with a low ceiling. The sound is very close and intimate.
9	<b>CHURCH</b>	This program recreates the acoustic environment of a big church with a high pointed dome and columns along the sides. This interior produces very long reverberations.
10	<b>CONCERT HALL</b>	In this program, the center will appear to be deep behind the main speakers, creating an expansive large hall ambience. Orchestra and opera music are suited for this sound field.

# ADVANCED FEATURES

## “SET MENU” mode

The following 13 functions maximize the performance of your system and increase the enjoyment of audio listening and video watching.

- |                   |                                    |                   |
|-------------------|------------------------------------|-------------------|
| 1. CENTER SPEAKER | 6. DOLBY DGTL SET<br>LFE LEVEL     | 9. CENTER DELAY   |
| 2. REAR SPEAKER   | 7. DOLBY DGTL SET<br>DYNAMIC RANGE | 10. PARAMETER INI |
| 3. MAIN SPEAKER   | 8. DTS SET<br>LFE LEVEL            | 11. MEMORY GUARD  |
| 4. LFE/BASS OUT   |                                    | 12. TV/DBS INPUT  |
| 5. MAIN LEVEL     |                                    | 13. DIMMER        |

## Changes and adjustments

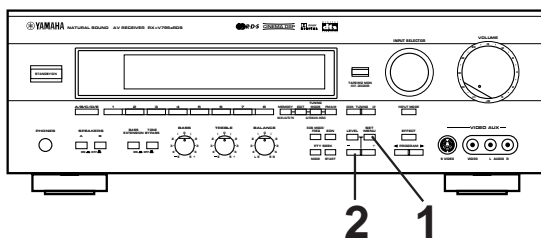

Select “AMP/TUN” or “DSP”.

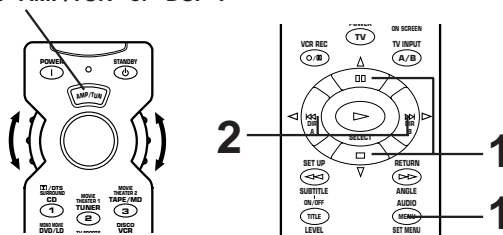

- Refer to the information in the display panel or monitor screen during operation. The monitor power must be turned on to display information on the monitor.
- When using the remote controller, the selector dial must be set at “AMP/TUN” or “DSP”.

**1** To make changes, select the applicable function by using one of the following methods.

**When operating on the front panel:**

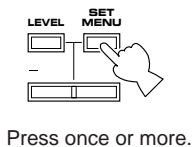

**When operating on the Remote controller:**

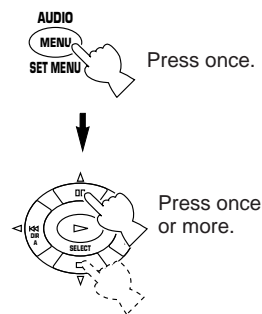

**2** Select the desired position or edit parameter for the function by using the following keys.

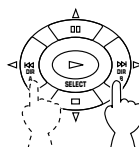
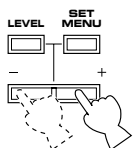

**3** Repeat steps 1 and 2 to change a setting or adjust for another function.

## ■ Function description

- |                   |                 |               |
|-------------------|-----------------|---------------|
| 1. CENTER SPEAKER | 3. MAIN SPEAKER | 5. MAIN LEVEL |
| 2. REAR SPEAKER   | 4. LFE/BASS OUT |               |
- (Selecting the output modes suitable for your speaker system)

Refer to pages 27 to 29 for details. (Once you have selected proper modes, you do not have to make a setting change, unless your speaker system is modified.)

### 6. DOLBY DGTL SET LFE LEVEL [Adjusting the output level at the LFE (low frequency effect) channel]

- **Control range:** -20 dB to 0 dB  
**Preset value:** 0 dB
  - This adjustment is effective only when Dolby Digital is decoded and the signals of the selected source encoded with Dolby Digital contain LFE signals.
- Adjusts the output level at the LFE (low frequency effect) channel. If the LFE signals are mixed with signals of other channels and they are output from the same speakers, the ratio of LFE signals to other signals can be adjusted. (Refer to page 5 for details about the LFE channel.)

### 7. DOLBY DGTL SET DYNAMIC RANGE (Adjusting dynamic range)

- **Choices:** MAX/STD/MIN  
**Preset position:** MAX
- This adjustment is effective only when Dolby Digital is decoded.

“Dynamic range” is the difference between the maximum level and the minimum level of sounds. Sounds on a movie originally designed for movie theaters feature very wide dynamic range.

Dolby Digital technology can bring the original sound track into a home audio format with this wide dynamic range unchanged. Powerful sounds of extremely wide dynamic range are not always suitable for home use. Depending upon the condition of your listening environment, it may not be possible to increase the sound output level as high as a movie theater. However, in a level suitable for listening in your room, the low level parts of source sound cannot be heard well because they will be lost among noises in your environment.

Dolby Digital technology also made it possible to reduce an original sound track’s dynamic range for a home audio format by “compressing” the data of sound.

**MAX:** In this position, a source encoded with Dolby Digital is reproduced in the original sound track’s wide dynamic range providing you with powerful sounds like a movie theater. Selecting this position will be more ideal if you can listen to a source in a high output level in a room specially soundproofed for audio/video enjoyment.

**STD (Standard):**

In this position, a source encoded with Dolby Digital is reproduced in the “compressed” dynamic range of the source suitable for low level listening.

**MIN:** In this position, dynamic range is more reduced than in the STD position. Selecting this position will be effective when you must listen to a source in an extremely low level.

\* In this position, it may happen that sound is output faintly or not output normally depending on a source. In that case, select the MAX or STD position.

## 8. DTS SET LFE LEVEL [Adjusting the output level at the LFE (low frequency effect) channel]

- **Control range:** -10 dB to 10 dB  
**Preset value:** 0 dB
- This adjustment is effective only when DTS is decoded and the signals of the selected source encoded with DTS contain LFE signals.

Adjusts the output level at the LFE (low frequency effect) channel. If the LFE signals are mixed with signals of other channels and they are output from the same speakers, the ratio of LFE signals to other signals can be adjusted. (Refer to page 5 for details about the LFE channel.)

## 9. CENTER DELAY [Adjusting the delay of center sounds (dialog etc.)]

- **Control range:** 0 ms to 5 ms (in 1 ms step)  
**Preset value:** 0 ms
- This adjustment is effective only when Dolby Digital or DTS is decoded and the signals of the selected source encoded with Dolby Digital or DTS contain center channel signals.

Adjusts the delay between the main sounds (at the main channels) and dialog etc. (at the center channel). The larger the value, the later the dialog etc. is generated. In your audio system, the distance from the center speaker to your listening position may be shorter than the distance from the left or right main speaker to your listening position. In that case, sounds from the left main, center and right main speakers can reach your listening position at the same time by delaying the sound from the center speaker.

## 10. PARAMETER INI (Initializing parameters on a DSP program)

You can initialize all parameter settings on a DSP program. Note that some DSP programs have two subprograms; all parameters on both subprograms are initialized by this operation.

### Initializing method

Use the remote controller for the operation. A program number whose parameters has been changed is marked with "★". First press the **DSP** key, and then press a DSP program selector key which corresponds to the program number whose parameters you want to initialize. When initialized, the "★" mark will disappear.

### Note

When the selector dial of the remote controller is set at "**DSP**", simply press the corresponding DSP program selector key.

## 11. MEMORY GUARD (Locking DSP parameters and other adjustments)

If you wish to prevent accidental alteration to DSP parameters and other adjustments on this unit, select "ON". In this position, they are locked and cannot be changed. The following functions on this unit can be locked by this operation.

- DSP parameters
- Other functions in the "SET MENU" mode
- **ON SCREEN** display key
- **LEVEL** key
- **TEST** key

## 12. TV/DBS INPUT (Selecting the initial input mode of the source connected to the TV/DBS input terminals)

For the source connected to the TV/DBS input terminals of this unit, you can designate the input mode that is automatically selected when the power of this unit is switched on.

- AUTO:** In this position, the AUTO input mode is always selected when the power of this unit is switched on.
- LAST:** In this position, the input mode you have selected the last time is memorized and will not be changed even if the power of this unit is switched off.

\* Refer to page 36 for details about switching the input mode.

## 13. DIMMER (Changing brightness of the display panel)

You can adjust the brightness of the display panel in five degree increments.

## Creating your own sound fields

### What is a sound field?

In order to explain the impressive functions of the DSP, we need to first understand what a sound field really is.

What really creates the rich, full tones of a live instrument are the multiple reflections from the walls of the room. In addition to making the sound “live”, these reflections enable us to tell where the player is situated, and the size and shape of the room in which we are sitting. We can even tell whether it is highly reflective with steel and glass surfaces, or more absorbent with wood panels, carpeting and curtains.

### The elements of a sound field

In any environment, in addition to the direct sound coming straight to our ears from the player's instrument, there are two distinct types of sound reflections that combine to make up the sound field:

(1) **Early Reflections.**

Reflected sounds reach our ears extremely rapidly (50 ms — 100 ms after the direct sound), after reflecting from one surface only—for example, from the ceiling or a wall. These reflections fall into specific patterns as shown in the diagram on page 62 for any particular environment, and provide vital information to our ears. Early reflections actually add clarity to the direct sound.

(2) **Reverberations.**

These are caused by reflections from more than one surface—walls, ceiling, the back of the room—so numerous that they merge together to form a continuous sonic “afterglow”. They are non-directional, and lessen the clarity of the direct sound.

Direct sound, early reflections and subsequent reverberation taken together help us to determine the subjective size and shape of the room, and it is this information that the DSP reproduces in order to create sound fields.

If you could create the appropriate early reflections and subsequent reverberations in your listening room, you would be able to create your own listening environment. The acoustics in your room could be changed to those of a concert hall, a dance floor, or virtually any size room at all. This ability to create sound fields at will is exactly what Yamaha has done with the DSP.

DSP programs consist of some parameters to determine apparent room size, reverberation time, distance from you to the performer, etc. In each program, these parameters are preset with values precisely calculated by Yamaha to create the sound field unique for the program. It is recommended to use DSP programs without changing values of parameters, however, this unit also allows you to create your own sound fields. Starting with one of the built-in programs, you can adjust those parameters. Even if the power cord of this unit is disconnected from the AC outlet, your custom sound fields will remain in the DSP's memory for about one week. The following page details how to make your own sound fields.

Each DSP program has a set of parameters that allow you to change the characteristics of the acoustic environment to precisely create the effect you want. For the programs which have subprograms, each subprogram has a set of parameters. These parameters correspond to the many natural acoustic factors that create the sound field you experience in an actual concert hall or other listening environment. The size of the room, for example, affects the length of time between the “early reflections”—that is, the first few widely spaced reflections you hear after the direct sound. The “ROOM SIZE” parameter provided in many of the DSP programs alters the timing between these reflections, thus changing the shape of the “room” you hear. In addition to room size, the shape of the room and the characteristics of its surfaces have a significant effect on the final sound. Surfaces that absorb sound, for example, cause the reflections and reverberations to die out quicker, while highly reflective surfaces allow the reflections to carry on for a longer period of time. The DSP parameters allow you to control these and many other factors that contribute to your personal sound field, allowing you to essentially “redesign” the concert halls, theaters, etc. provided to create custom-tailored listening environments that ideally match your mood and music.

Refer to “Descriptions of the digital sound field parameters” on pages 62 to 63 for a description of what each parameter does, how it effects the sound, and its control range.

## ■ Selecting and editing program parameters

This adjustment can be made only by using the remote controller and watching the monitor screen or the display panel.

### Note

Information on the monitor screen would be easier to see than the display panel.

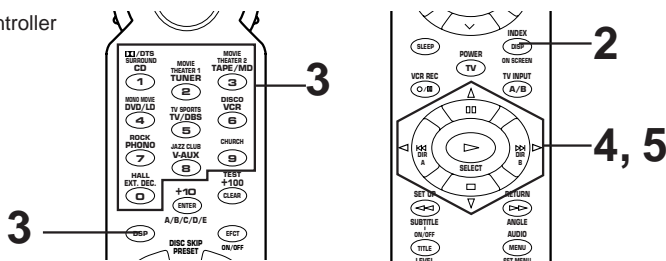

**1** Set the selector dial of the remote controller to “DSP” or “AMP/TUN”.

**2** Turn on your monitor. If the currently selected type of display is not the full display, press the **ON SCREEN** display key and select the full display.

**3** Select the desired program (or subprogram) by following the steps 2 and 3 of “Playing a source with an effect of the digital sound field processor (DSP)” on pages 48 and 49.

The selected program name and its parameters will be displayed on the monitor screen. The arrow-shaped cursor points to the first parameter or subprogram name.

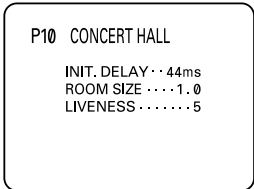

**4** Select the parameter which you want to edit.

**5** Change the value on the selected parameter to create the effect you want.

“▶” increases the value of the selected parameter, and “◀” decreases the value of the selected parameter. In both cases you can hold the key down to quickly move to the desired value.

The display will pause for a moment at the initial set value of the parameter as a reminder. (On the monitor screen, the \* mark at the head of the parameter name will disappear upon reaching the initial set value of the parameter.)

### Notes

- For details about parameters, refer to pages 62 to 63.
- Parameter edits made in this way will remain in effect even if power is lost due to a power failure or the power plug is disconnected from the AC outlet for up to about one week, after which all parameters, as well as other adjustments or setting changes on this unit, will return to their initial values or conditions.

## ■ Descriptions of the digital sound field parameters

Not all of the following parameters are found in every program.

### ● ROOM SIZE

*How it Affects the Sound:*

Changes the apparent size of the music venue. The larger the value, the larger the simulated room will sound.

*What it Does:*

Adjusts the timing between the early reflections. Early reflections are the first group of reflections you hear before the subsequent, dense reverberation begins.

*Control Range:*

0.1 – 2.0  
Standard setting is 1.0.

Changing this parameter from 1 to 2 increases the apparent volume of the room eight times (length, width, and height all doubled).

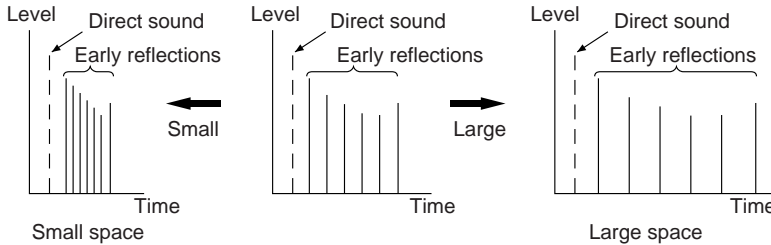

### P. ROOM SIZE (Presence Room Size)

Adjusts the apparent space size of the front presence sound field. The larger the value, the longer the interval between reflections becomes, which increases the depth of the sound source.

### S. ROOM SIZE (Surround Room Size)

Adjusts the apparent space size of the rear surround sound field. The larger the value, the larger the surround sound field becomes.

### ● INIT. DELAY (Initial Delay)

*How it Affects the Sound:*

Changes the apparent distance from the source sound.

Since the distance between a sound source and a reflective surface determines the delay between the direct sound and the first reflection, this parameter changes the location of the sound source within the acoustic environment.

*What it Does:*

Adjusts the delay between the direct sound and the first reflection heard by the listener.

*Control Range:*

1 – 99 milliseconds

For a small living room this parameter would be set for a small value. Large values for a big room. Larger values produce an echo effect.

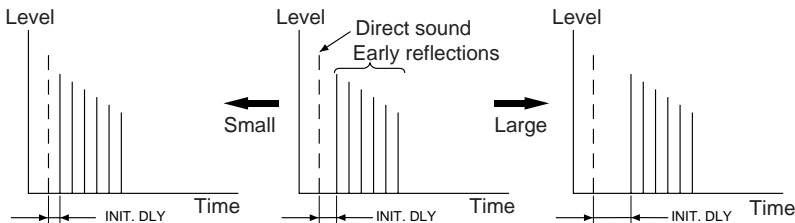

### P. INIT. DLY (Presence Initial Delay)

Adjusts the delay between the direct sound and the first reflection on the presence side of the sound field. The larger the value, the later the first reflection begins.

*Control Range:*

1 – 99 milliseconds

### S. INIT. DLY (Surround Initial Delay)

Adjusts the delay between the direct sound and the first reflection on the rear surround side of the sound field. The larger the value, the later the first reflection begins.

*Control Range:*

1 – 49 milliseconds



## ● LIVENESS

*How it Affects the Sound:*

This parameter changes the apparent reflectivity of the walls in the hall.

The early reflections from a sound source will lose intensity (decay) much faster in a room with acoustically absorbent wall surfaces than in one which has mostly reflective surfaces. A room with highly reflective surfaces in which the early reflections decay slowly is termed "live", while a room with absorbent characteristics in which the reflections decay rapidly is termed "dead". The LIVENESS parameter lets you adjust the early reflection decay rate, and thus the "liveness" of the room.

*What it Does:*

Changes the rate at which the early reflections decay.

*Control Range:*

0 – 10.

### LIVENESS (Presence Liveness)

Adjusts the apparent reflectivity of the walls on the front presence sound field. The larger the value, the more reflective the front presence sound field becomes.

### S. LIVENESS (Surround Liveness)

Adjusts the apparent reflectivity of the walls on the rear surround sound field. The larger the value, the more reflective the rear surround sound field becomes.

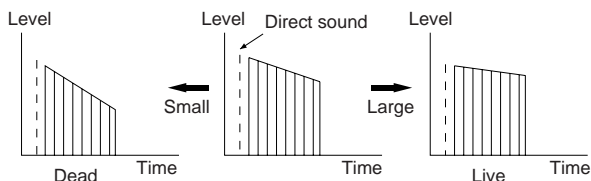

## ● REV. TIME (Reverberation Time)

*How it Affects the Sound:*

The natural reverberation time of a room depends primarily on its size and the characteristics of its inner surfaces. This parameter, therefore, changes the apparent size of the acoustic environment over an extremely wide range.

*What it Does:*

Adjusts the amount of time it takes for the level of the dense, subsequent reverberation sound to decay by 60 dB (1 kHz).

*Control Range:*

1.0 – 5.0 seconds.

The reverb time in a small-to-medium size hall would be between 1 and 2, and in a large hall it is normally between 2 and 3.

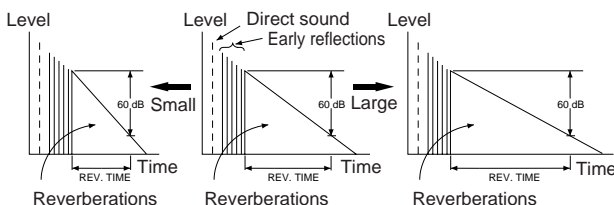

## ● REV. LEVEL (Reverberation Level)

This parameter adjusts the volume of the reverberation sound. The larger the value, the stronger the reverberation becomes.

*Control Range:*

0 – 100%

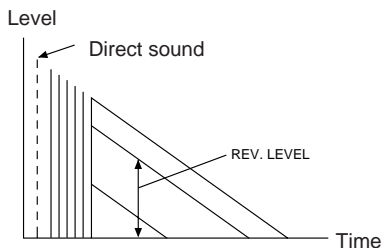

## ● S. DELAY (Surround Delay)

Adjusts the delay between the direct sound and the first reflection on the rear surround side sound field. The larger the value, the later the surround sound field is generated.

*Control Range:*

When Dolby Surround is decoded:

15 – 30 milliseconds

When Dolby Digital or DTS is decoded:

0 – 15 milliseconds

When a program without Dolby Surround or DTS encoded is used:

15 – 49 milliseconds

## Setting the SLEEP timer

Use the built-in SLEEP timer to automatically turn this unit into the standby mode after the time you set elapses. The SLEEP timer is useful when you plan to fall asleep while this unit is playing back or recording a source. The SLEEP timer also automatically turns off external units connected to the SWITCHED AC OUTLET(S) on the rear of this unit. The SLEEP timer can only be set using the remote controller.

### To set the SLEEP time

- 1** Select the source using the **INPUT SELECTOR** and start playback (or select a broadcast station) on the source unit.
- 2** Press the **SLEEP** key repeatedly until the desired SLEEP time appears on the display.  
\* "SLEEP time" is the time that elapses before this unit is automatically turned into the standby mode.

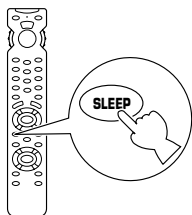

Indicates the SLEEP time.

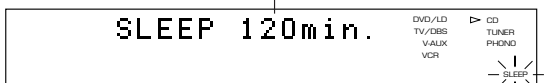

Flashes.

Each time you press the **SLEEP** key, the SLEEP time changes as follows.

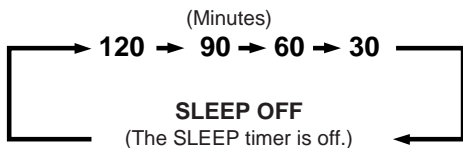

After a while, the display returns to the original indication.

### To cancel the SLEEP timer

Press the **SLEEP** key repeatedly until "SLEEP OFF" appears on the display. (After a while, the display returns to the original indication.)

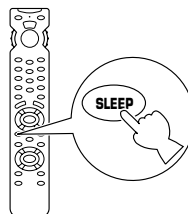

#### Note

The SLEEP timer setting can also be canceled by setting this unit into the standby mode with the **STANDBY/ON** switch on the front panel (or the **STANDBY** key on the remote controller) or disconnecting the power plug of this unit from the AC outlet.

# REMOTE CONTROLLER

The remote controller is designed to control the most commonly used functions. If you have other Yamaha audio and video components with remote control capability, this remote controller will also control various functions of them. In addition, this remote controller can control other manufacturers' audio and video components by programming the remote controller with the codes for other manufacturers.

## Basic operation

- 1** Select the position for the component that you want to control by turning the **selector dial**.  
**Note:** Turn the **selector dial** until it stops with a click.

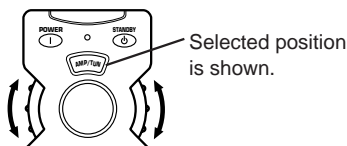

- 2** Press an operation key.  
**Note:** Press a key with the remote controller aimed at the front panel.

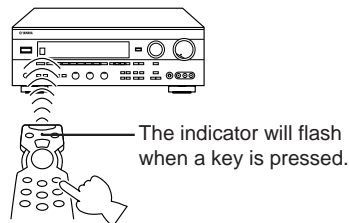

## Components which can be controlled

The selector dial can be turned to select nine positions. The components which can be controlled with the remote controller differs depending on the selected position. Refer to the diagram below to know what components can be controlled for each position.

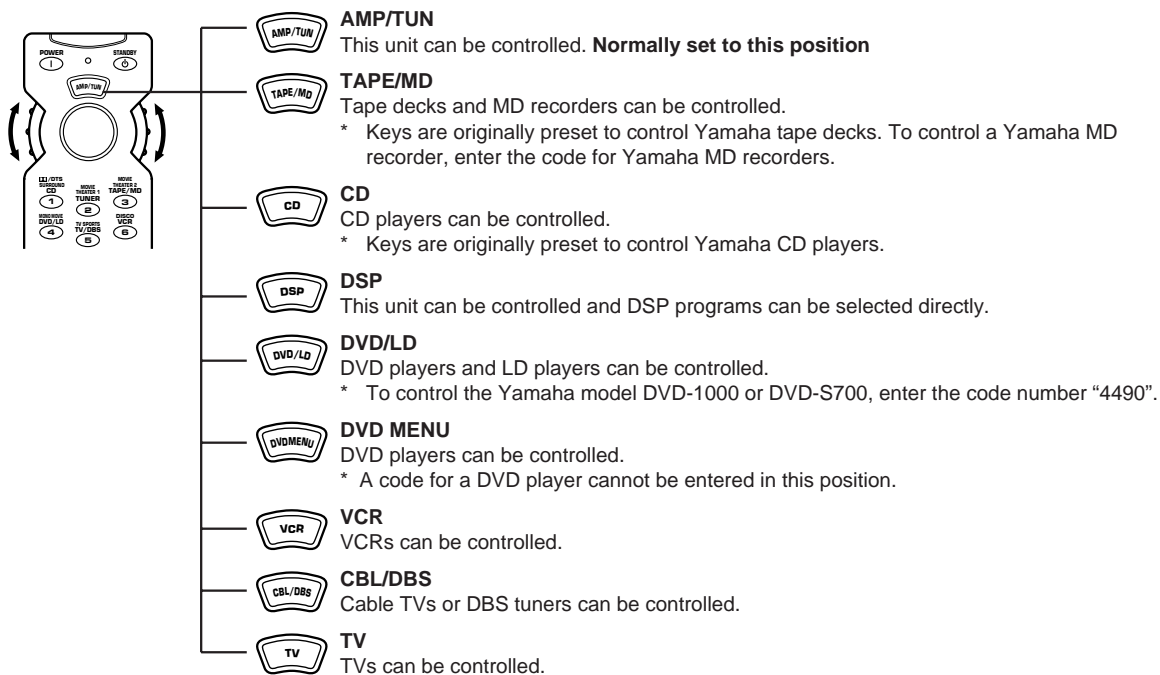

### Notes

- You can program the remote controller with the codes for other manufacturers for all positions (except AMP/TUN and DSP) respectively.  
For example, if your CD player is not a Yamaha model, enter the code for the manufacture of the CD player when the CD position is selected. You can control your CD player with the remote controller when the CD position is selected.  
**You can enter one code for one position.**  
Refer to page 71 for details about entering codes.
- Some Yamaha CD players and tape decks cannot be controlled with the default codes. To control such a model, enter the code for the model in the corresponding position.
- For the DVD/LD and DVD MENU positions:  
If you enter a code for a DVD player in the DVD/LD position, the keys in the DVD MENU position become also available for controlling the DVD player. You cannot enter a code for a DVD player when the DVD MENU is selected.
- You can enter the code for your second (or third) VCR in the CBL/DBS position if you do not use a cable TV, DBS tuner, etc. You can also enter the code for your second (or third) VCR in the DVD MENU position if you do not use a DVD player. In this case, however, you must enter a code for an LD player in the DVD/LD position even if you do not use an LD player. Refer to page 71 for details.

# Key name and function

The key functions differ depending on the position selected by the selector dial as shown below.

## AMP/TUN

\* The keys drawn in a light tone do not function.

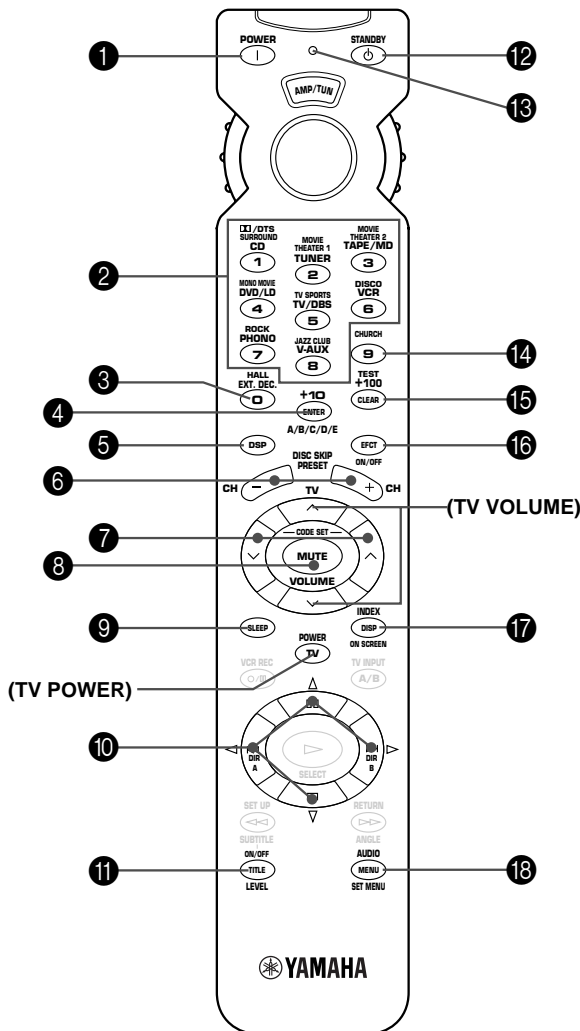

### 1 POWER

Press this key to turn on the power of this unit.

### 2 Input selector keys

Press a key to select the input source.

### 3 EXT. DEC.

Press this key to select the input signals from the EXTERNAL DECODER INPUT terminals as the input source. This function takes priority over the input selector key setting. "EXT. DECODER" will be illuminated on the display panel.

The source selected with the input selector keys becomes the current input source when "EXT. DECODER" is not illuminated on the display panel.

\* If the **DSP** key (5) is pressed, you can select the HALL program by pressing this key while the indicator (13) is illuminated.

### 4 A/B/C/D/E

Press this key to select a group of preset stations.

### 5 DSP

Press this key. While the indicator (13) is illuminated for about three seconds, select a DSP program using the keys (2, 3, 14). No DSP program can be selected after the indicator goes off.

### 6 PRESET +/-

+: Press this key to select the next preset station number.  
-: Press this key to select the previous preset station number.

### 7 VOLUME ^ (up)/ v (down)

Press these keys to increase or decrease the volume.

### 8 MUTE

Press this key to mute the volume. The volume can be returned to the original level by pressing any remote controller key which controls this unit. The indicator on the **VOLUME** control flashes during the mute mode.

### 9 SLEEP

Press this key to turn the built-in SLEEP timer on and off, and set the SLEEP time. (Refer to page 64.)

### 10 Δ / ▽ / ◀ / ▶

The Δ (up) and ▽ (down) keys select the DSP parameters, or select speaker(s) or functions according to the mode selected by the **LEVEL** or **SET MENU** key. The ◀ or ▶ keys adjust or make changes in the selected parameter, speaker(s) or function.

**Note**

**TV POWER** and **TV VOLUME** function if you have entered the code for your TV.

**11 LEVEL**

This key is used to adjust the output level of the center speaker, rear speakers and subwoofer. First, press this key. Then select the speaker(s) by pressing this key repeatedly or by using the  $\Delta$  or  $\nabla$  key (10). The name will be illuminated on the display. Then press the  $\triangleleft$  or  $\triangleright$  key (10) to change the output level.

**12 STANDBY**

Press this key to set this unit in the standby mode.

**13 Indicator**

This indicator flashes when a key is pressed on the remote controller. (Transmitting infrared signals.)

**14 CHURCH**

If the **DSP** key (5) is pressed, you can select the CHURCH program by pressing this key while the indicator (13) is illuminated.

**15 TEST**

This key is used when adjusting the speaker balance. (Refer to pages 30 to 32.)

**16 EFCT ON/OFF**

Press this key to turn on/off the digital sound field processor, which includes the Dolby Pro Logic decoder, Dolby Digital decoder and DTS decoder.

**17 ON SCREEN**

Press this key to change the type of display on the monitor screen. Three types of displays are available. Each time the key is pressed, the information can be changed to a full, simple and no display.

**18 SET MENU**

Press this key to turn the unit into the SET MENU mode. Select a function by pressing this key repeatedly or by using the  $\Delta$  or  $\nabla$  key (10). The function name will be illuminated on the display. Then press the  $\triangleleft$  or  $\triangleright$  key (10) to adjust or make settings in the function.

**DSP**



DSP program selector keys

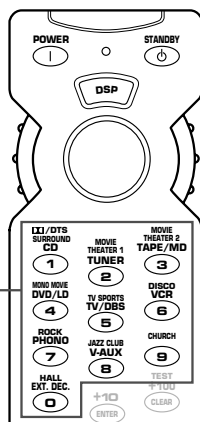

The functions of all keys are the same with the **AMP/TUN** position except the **DSP program selector keys** figured on the left.

**DSP program selector keys**

Press a key corresponding to the DSP program you want to select. The program is directly selected.

**Note:** Press "0" to select the program No. 10.



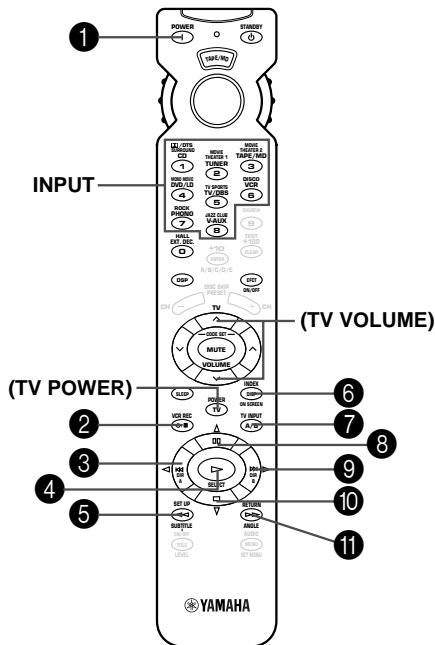

The keys drawn in a light tone do not function. For the keys which are not described here, see "AMP/TUN" on page 66. For details, refer to the instruction manual for each of your components.

**TAPE/MD** 











**Note**  
**TV POWER** and **TV VOLUME** function if you have entered the code for your TV.

**For tape decks**

- 1 POWER**  
 This key turns on this unit when the default code is used. If another code is entered and your tape deck's remote controller has a power key, this key will turn on the tape deck.
- 2  REC/PAUSE**  
 Press this key to set the tape deck in the recording pause mode.
- 3 DIR A**  
 Press this key to select the playing direction of DECK A.
- 4  PLAY**  
 Press this key to play a tape.
- 5  REWIND**  
 Press this key to rewind a tape.
- 7 DECK A/B**  
 Press this key to select A or B on a double cassette tape deck.
- 9 DIR B**  
 Press this key to select the playing direction of DECK B.
- 10  STOP**  
 Press this key to stop a tape.
- 11  FAST FORWARD**  
 Press this key to fast forward a tape.

**For MD recorders**

Enter the proper code for your MD recorder.

- 1 POWER**  
 This key turns on this unit if a code for a Yamaha MD recorder is entered. If another manufacturer's code is entered and your MD recorder's remote controller has a power key, this key will turn on the MD recorder.
- 2  REC/PAUSE**
- 3  SKIP**
- 4  PLAY**
- 5  BACKWARD**
- 6 DISPLAY**
- 8  PAUSE**
- 9  SKIP**
- 10  STOP**
- 11  FAST FORWARD**

The keys drawn in a light tone do not function. For the keys which are not described here, see "AMP/TUN" on page 66. For details, refer to the instruction manual for each of your components.

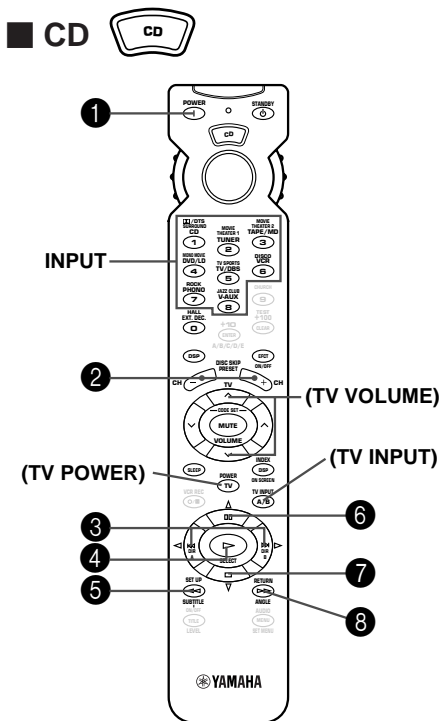

**Note**

**TV POWER, TV VOLUME and TV INPUT** function if you have entered the code for your TV.

- 1 POWER**  
This key turns on this unit when the default code is used. If another code is entered and your CD player's remote controller has a power key, this key will turn on the CD player.
- 2 DISC SKIP**  
Press these keys to skip to the next or previous CD.
- 3 <, > SKIP**  
Press > to skip to the beginning of the next track.  
Press < to skip to the beginning of the current or previous track.
- 4 > PLAY**  
Press this key to play a CD.
- 5 << BACKWARD**  
Press this key to reverse playback rapidly.
- 6 || PAUSE**  
Press this key to pause playback. This key functions as **PAUSE/STOP** for operating Yamaha CD players under default settings.
- 7 □ STOP**  
Press this key to stop playback. This key functions as **PAUSE/STOP** for operating Yamaha CD players under default settings.
- 8 >> FAST FORWARD**  
Press this key to advance playback rapidly.

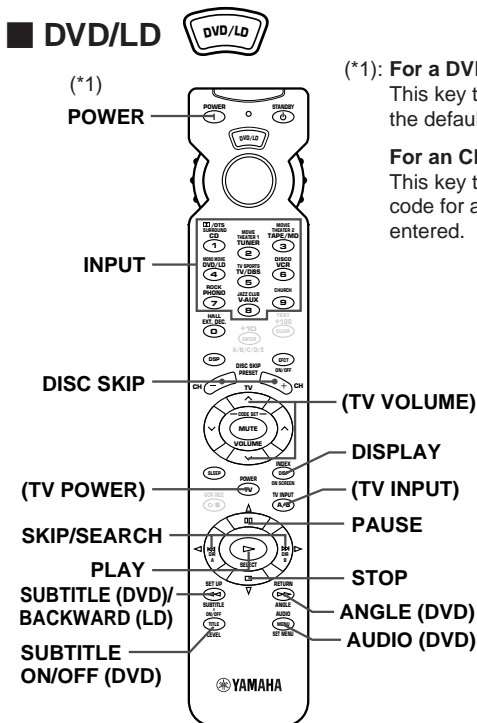

- (\*1): For a DVD player:  
This key turns on this unit when the default code is used.
- For an CD player:  
This key turns on this unit if a code for a Yamaha LD player is entered.

**Note**  
**TV POWER, TV VOLUME and TV INPUT** function if you have entered the code for your TV.

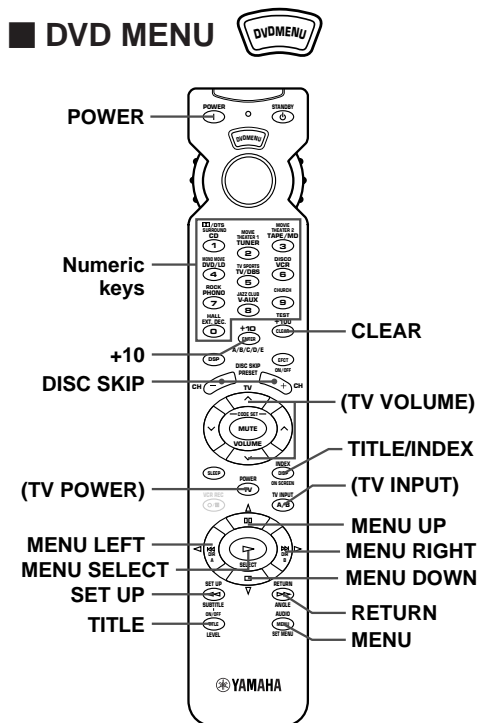

**Note**  
**TV POWER, TV VOLUME and TV INPUT** function if you have entered the code for your TV.

The keys drawn in a light tone do not function. For the keys which are not described here, see "AMP/TUN" on page 66. For details, refer to the instruction manual for each of your components.

**VCR** 

**Note**  
**TV POWER, TV VOLUME** and **TV INPUT** function if you have entered the code for your TV.

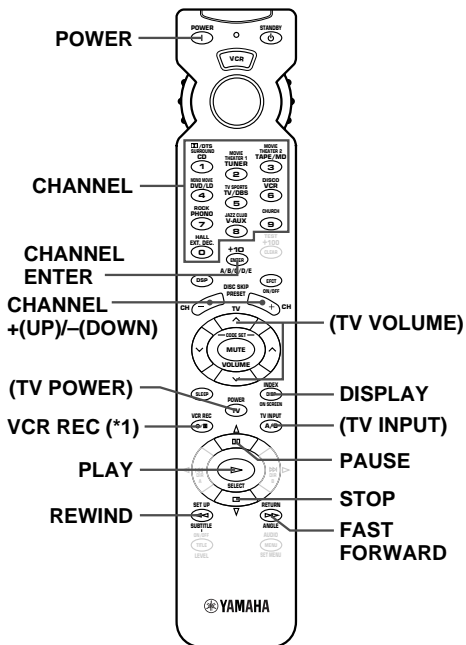

(\*1) Press this key twice to start recording.

**TV** 

**Note**  
 You can control your VCR if you have entered the code for it.

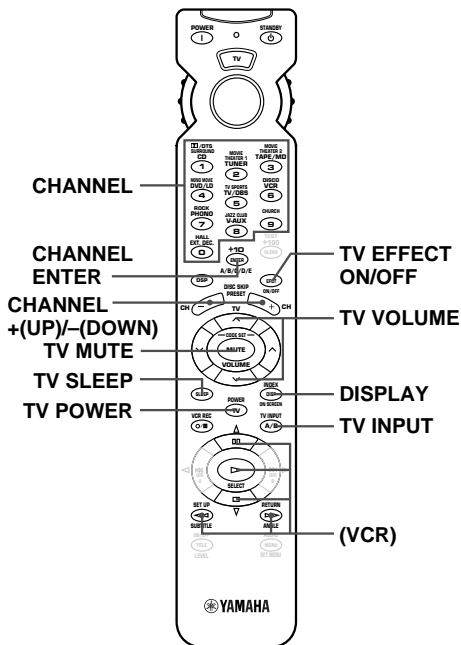

**CBL/DBS** 

**Note**  
**TV POWER, TV VOLUME** and **TV INPUT** function if you have entered the code for your TV.

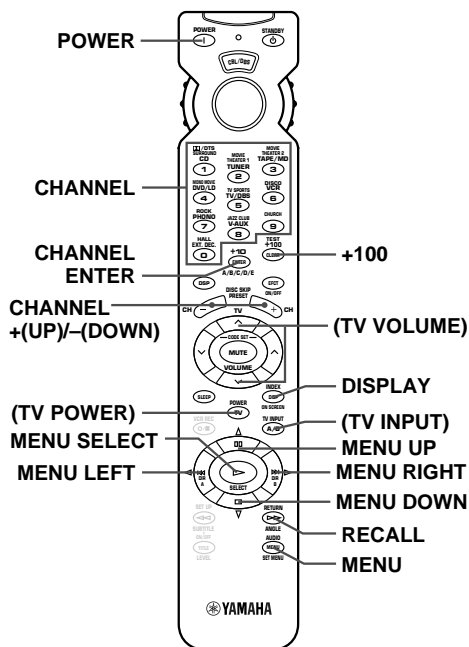



# Entering manufacturer codes

If you have a component which is not a Yamaha model, you can enter the code for the manufacturer of the component in the corresponding position of the selector dial. By doing so, you can control the component with the remote controller.

**Refer to the code list at the end of this manual for the code numbers you need.**

### Notes

- Some Yamaha CD players and tape decks cannot be controlled with the default codes. To control such a model, enter the code for the model in the corresponding position.
- If there is no code applicable for your component in the code list, you must use the remote controller provided for the component.

## Entering a code

- Set the selector dial to the position for controlling the component. (For example, set to "VCR" for a VCR.)

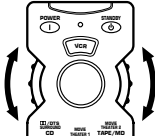
- Press both of the **VOLUME** ^ and v keys at the same time and hold them until the indicator flashes twice.

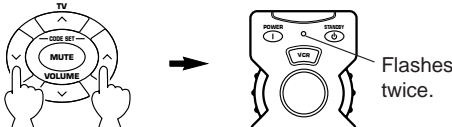
- Use the numeric keys to enter the four-digit manufacturer code for the component to be used. Make sure that the indicator flashes twice.

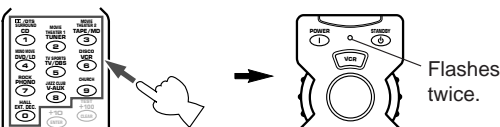

\* If the indicator does not flash, repeat step 3 and enter the code again.
- Try operating the component with the remote controller to check the code entering is successful.

### Note

If the component cannot be controlled, enter another code for the same manufacturer.

## Entering a code for a second (or third) VCR

You can use the CBL/DBS or DVD MENU position, or both of them to control a second (and/or third) VCR if you do not use a cable TV, DBS tuner, DVD player etc.

\* If you will use the DVD MENU position for a second (or third) VCR, you must enter the code for an LD player in the DVD/LD position.

- Set the selector dial to the CBL/DBS or DVD MENU position.

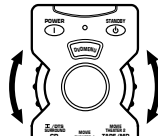
- Press both of the **VOLUME** ^ and v keys at the same time and hold them until the indicator flashes twice.

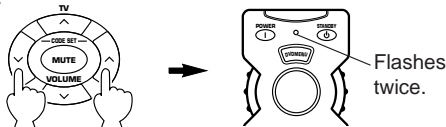
- Press the **MUTE** key.

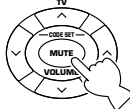
- Use the numeric keys to enter the four-digit manufacturer code for the second (or third) VCR. Make sure that the indicator flashes twice.

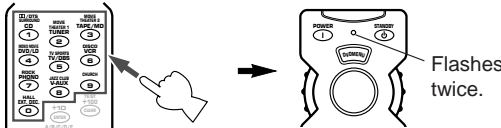

\* If the indicator does not flash, repeat step 4 and enter the code again.
- Try operating the component with the remote controller to check the code entering is successful.

### Note

If the component cannot be controlled, enter another code for the same manufacturer.

## Restoring the default codes

To restore the default codes for the all positions.

**1** Press both of the **VOLUME** ^ and v keys at the same time and hold them until the indicator flashes twice.

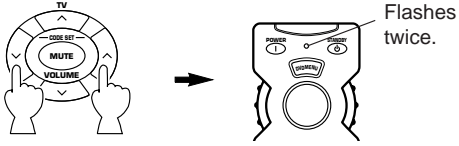

**2** Enter the code number "9987".  
\* Make sure that the indicator flashes twice.

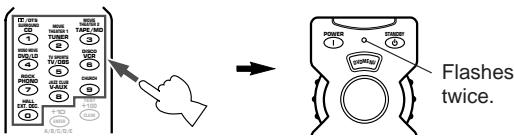

To restore the default code for each position

**1** Set the selector dial to the position for which you want to restore the default code.

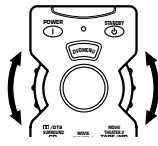

**2** Press both of the **VOLUME** ^ and v keys at the same time and hold them until the indicator flashes twice.

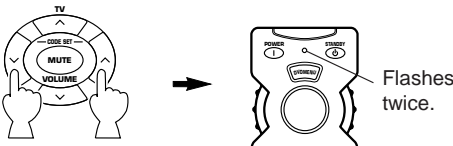

**3** Enter the code number "9999".  
\* Make sure that the indicator flashes twice.

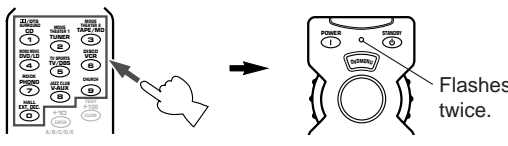

### Default codes

The following codes are preset as the default code.

Position	Component	Code
TV	TV	0037
CBL/DBS	DBS tuner	2455
VCR	VCR	3072
DVD/LD	DVD player	4545 YAMAHA
CD	CD player	6187 YAMAHA
TAPE/MD	Tape deck	8524 YAMAHA

We recommend that you write all code numbers you have entered on the "Quick Reference Card".

# TROUBLESHOOTING

Refer to the chart below when this unit does not function properly. If the problem you are experiencing is not listed below or if the instruction below does not help, disconnect the power cord and contact your authorized YAMAHA dealer or service center.

## General

Problem	Cause	What to Do
<b>The unit fails to turn on when the STANDBY/ON switch is pressed, or turns into the standby mode suddenly soon after the power is turned on.</b>	Power cord is not plugged in or is not completely inserted.	Firmly plug in the power cord.
	The IMPEDANCE SELECTOR switch on the rear panel is not set to either end.	Set the switch to either end when this unit is in the standby mode.
<b>This unit does not work normally.</b>	There is an influence of strong external noise (lightning, excessive static electricity, etc.) or a misoperation on this unit while using this unit.	Turn this unit into the standby mode and disconnect the AC power cord from the AC outlet. After about 30 seconds have passed, connect the power and operate this unit again.
<b>No sound or no picture.</b>	Incorrect output cord connections.	Connect the cords properly. If the problem persists, the cords may be defective.
	Appropriate input source is not selected.	Select the appropriate input source with the INPUT SELECTOR or the TAPE/MD MON/EXT. DECODER button.
	Speaker connections are not secure.	Secure the connections.
	Digital signals other than PCM audio and Dolby Digital (or DTS) encoded signals which this unit cannot reproduce are input to this unit by playing a CD-ROM etc.	Play a source whose signals this unit can reproduce.
<b>No picture</b>	There is no S video terminal connection between this unit and the TV, though S video signals are input to this unit.	Connect this unit's S VIDEO MONITOR OUT terminal to the TV's S video input terminal.
<b>The sound suddenly goes off.</b>	The protection circuit has been activated because of short circuit etc.	Turn this unit into the standby mode, and then turn on to reset the protection circuit.
	The SLEEP timer came on.	Cancel the SLEEP timer function.
<b>Only one side speaker outputs the sound.</b>	Incorrect setting of the BALANCE control.	Adjust it to the appropriate position.
	Incorrect cord connections.	Connect the cords properly. If the problem persists, the cords may be defective.
<b>No sound from the effect speakers.</b>	The EFFECT button is set off.	Press the EFFECT button to turn it on.
	A Dolby Surround (or DTS) decoding program is being used with material not encoded with Dolby Surround (or DTS).	Use a different sound field program.
<b>No sound from the center speaker.</b>	The function "1. CENTER SPEAKER" in the SET MENU mode is set to the "NONE" position.	Select the appropriate position.
	One of the DSP programs No. 6 to No. 10 is selected when the input signal of source is 2-channel stereo (analog/PCM).	Select another program.
	The input signals of source encoded with Dolby Digital or DTS do not have center channel signals.	Refer to the instructions for the source currently played.
<b>Poor bass reproduction.</b>	The function "4. LFE/BASS OUT" in the SET MENU mode is set in the SW or BOTH position, though your system does not include a subwoofer.	Select the MAIN position.
	Output mode selection for each channel (MAIN, CENTER or REAR) is improper.	Make output mode selections suitable for your speaker system.
<b>Sound "hums".</b>	Incorrect cord connections.	Firmly connect the audio plugs. If the problem persists, the cords may be defective.
	No connection from the turntable to the GND terminal.	Make the GND connection between the turntable and this unit.
<b>The volume level is low while playing a record.</b>	The record is being played on a turntable with an MC cartridge.	The player should be connected to the unit through the MC head amplifier.
<b>The volume level cannot be increased, or sound is distorted.</b>	The component connected to the TAPE/MD OUT terminals of this unit is turned off.	Turn on the power to the component.

Problem	Cause	What to Do
DSP parameters and some other settings on this unit cannot be changed.	The function "11. MEMORY GUARD" in the SET MENU mode is set to the "ON" position.	Set to the "OFF" position.
"INPUT DATA ERR" appears on the display and no sound is heard.	A nonstandardized source is played back, or the unit playing back a source is misoperating.	Check the source, or turn off the unit playing back the source and then turn on again.
The sound field cannot be recorded.	It is not possible to record the sound field on a tape deck connected to this unit's TAPE/MD OUT terminals.	
This unit does not operate properly.	The internal microcomputer has been frozen by an external electric shock (lightning, excessive static electricity, etc.) or power supply with low voltage.	Unplug the AC power cord from the wall AC outlet, and then plug in again after about one minute.
A source cannot be recorded by a tape deck or VCR connected to this unit.	The source unit is connected to this unit between digital terminals only.	Make additional connection between analog terminals.
Noise from nearby TV or tuner.	This unit is too close to the affected equipment.	Move the unit further away from the affected equipment.
The sound is degraded when listening with the headphones connected to the compact disc player or tape deck that is connected with this unit.	This unit is in the standby mode.	Turn the power to this unit on.

## Remote controller

Problem	Cause	What to Do
The remote controller does not work.	The batteries of this remote controller are weak.	Replace the batteries with new ones.
The remote controller does not function properly.	Wrong distance or angle.	The remote controller will function from a maximum range of 6 meters, no more than 30 degrees off-axis from the front panel.
	Direct sunlight or lighting (of an inverter type of fluorescent lamp etc.) is striking the remote control sensor of the main unit.	Change position of the main unit.
This unit or another component cannot be controlled with the remote controller.	The selector dial of the remote controller is not set at the proper position.	Set the selector dial to the proper position.
	The code for controlling the component is not preset to the remote controller.	Enter the code for controlling the component in the corresponding position of the remote controller.

## Tuner

	Problem	Cause	What to Do
FM	FM stereo reception is noisy.	Because of the characteristics of FM stereo broadcasts, this is limited to cases where the transmitter is too far away or the antenna input is poor.	Check the antenna connections. Try using a high quality directional FM antenna. Set the TUNING MODE button to the manual tuning mode.
	There is distortion and clear reception cannot be obtained even with a good FM antenna.	There is multipath interference.	Adjust antenna placement to eliminate multipath interference.
	A desired station cannot be tuned in with the automatic tuning method.	The station is too weak.	Use the manual tuning method. Use a high quality directional FM antenna.
	Previously preset stations can no longer be tuned in.	This unit has been unplugged for a long period.	Repeat the presetting procedure.
AM	A desired station cannot be tuned in with the automatic tuning method.	Weak signal or loose antenna connections.	Tighten the AM loop antenna connections and rotate it for best reception. Use the manual tuning method.
	There are continuous crackling and hissing noises.	Noises result from lightning, fluorescent lamps, motors, thermostats and other electrical equipment.	Use an outdoor antenna and a ground wire. This will help somewhat but it is difficult to eliminate all the noises.
	There are buzzing and whining noises (especially in the evening).	A television set is being used nearby.	Relocate this unit away from the TV.

## When playing back a source encoded with DTS:

Problem	Cause	What to Do
A loud hissing noise is heard when you play back a source encoded with DTS.	The player which plays back the source is not connected to a digital audio signal input terminal of this unit.	The player must be connected to a digital audio signal input terminal of this unit besides analog audio signal terminal connections.
	The "ANALOG" input mode is selected on this unit.	Select a proper input mode on this unit to turn on the DTS decoder built into this unit.
A percussive noise is heard when you begin playing back a source encoded with DTS.	If the "AUTO" input mode is selected, depending on some sources, there may be a case that a noise is heard while this unit is identifying the format of input signal.	Set the input mode of the currently selected input source to "DTS".
No sound is heard when you play back a source encoded with DTS, even though the "AUTO" or "DTS" input mode is selected on this unit.	The DTS decoder built into this unit does not function because the player has a digital volume control and it is set at a position other than "maximum", "neutral" or "ineffective".	Set the player's digital volume control at the maximum, neutral or ineffective position.
No sound is heard when you play back an MD onto which you have recorded a source encoded with DTS.	A source encoded with DTS cannot be recorded onto an MD.	/
No sound is heard when you play back a DAT onto which you have recorded a source encoded with DTS.	Depending on a DAT deck, a source encoded with DTS cannot be recorded onto a DAT.	
No sound is heard when you play back a source (CD etc.) even though the currently selected input mode is "AUTO".	In the "AUTO" mode, DTS-decoding mode cannot be changed to the normal (PCM) digital signal input mode automatically.	Press the INPUT MODE button on the front panel or the input selector button (for the currently selected source) on the remote controller so that "PCM" appears on the monitor screen.

## Notes

- It is necessary to use a DTS decoder to play back a source encoded with DTS, so the player which plays back a source must be connected to a digital audio input terminal of this unit in the way described in this manual. If this connection is not made or only a D-to-A converter is used without using a DTS decoder, when you play back a source, only a loud hiss noise will be heard.
- If you make a search (or skip etc.) operation while playing back a source encoded with DTS, the "dts" indicator goes out from the display. This is because this unit automatically changes the DTS-decoding mode to the standard (PCM) digital signal input mode to prevent a noise from being output.
- A source encoded with DTS cannot be recorded onto analog audio and video tapes, and also, an analog tape recorded with a source encoded with DTS cannot be played back.  
The same result is obtained for MDs and DATs (depending on a DAT deck used for recording and/or playback).

# SPECIFICATIONS

## AUDIO SECTION

Minimum RMS Output Power Per Channel  
(Power Amp. Section)

(When both channels are driven)

MAIN L/R

20 Hz to 20 kHz, 0.04% THD, 8 ohms  
..... 85W+85W  
1 kHz, 0.07% THD, 8 ohms

..... 100W+100W

CENTER

20 Hz to 20 kHz, 0.04% THD, 8 ohms  
..... 85W  
1 kHz, 0.07% THD, 8 ohms

..... 100W

REAR L/R

20 Hz to 20 kHz, 0.04% THD, 8 ohms  
..... 85W+85W  
1 kHz, 0.07% THD, 8 ohms

..... 100W+100W

Maximum Power (EIAJ) [China and General  
models only]

1 kHz, 10% THD, 8 ohms

(When both channels are driven)

MAIN L/R ..... 125W+125W

CENTER ..... 125W

REAR L/R ..... 125W+125W

Dynamic Power Per Channel

(by IHF Dynamic Headroom Measuring Method)

MAIN L/R (8 ohms/6 ohms/4 ohms/2 ohms)

(When both channels are driven)

..... 115W/140W/170W/200W

Dynamic Headroom

[U.S.A. and Canada models only]

MAIN L/R (8 ohms) ..... 1.31 dB

DIN Standard Output Power Per Channel

[Europe, U.K. and Singapore models only]

MAIN L/R (1 kHz, 0.7% THD, 4 ohms)

(When both channels are driven) ..... 130W

IEC Power

[Europe, U.K. and Singapore models only]

MAIN L/R (1 kHz, 0.04% THD, 8 ohms)

(When both channels are driven) ..... 95W

Power Band Width

8 ohms, 40W, 0.09% THD

(When both channels are driven)

MAIN L/R ..... 10 Hz to 50 kHz

Damping Factor (SPEAKER A)

MAIN L/R (20 Hz to 20 kHz, 8 ohms)

..... 80 or more

Input Sensitivity/Impedance

CD/TAPE-MD/DVD-LD/TV-DBS/VCR

/VIDEO AUX ..... 150 mV/47 k-ohms

PHONO MM ..... 2.5 mV/47 k-ohms

Maximum Input Signal

CD/TAPE-MD/DVD-LD/TV-DBS/VCR

/VIDEO AUX (EFFECT ON)

(1 kHz, 0.5% THD) ..... 2.2V or more

PHONO MM (1 kHz, 0.04% THD)

..... 110 mV or more

Output Level/Impedance

REC OUT ..... 150 mV/1.0 k-ohms

PRE OUT ..... 2.6V/1.1 k-ohms

SUBWOOFER (MAIN SP: SMALL)

..... 4.0V/1.2 k-ohms

Headphone Jack Rated Output/Impedance

Output Level

CD/TAPE-MD/DVD-LD/TV-DBS/VCR

/VIDEO AUX Input: 1 kHz,

150 mV, RL=8 ohms ..... 0.55V

Impedance ..... 390 ohms

Frequency Response (20 Hz to 20 kHz)

CD/TAPE-MD/DVD-LD/TV-DBS/VCR

/VIDEO AUX to MAIN L/R SP OUT

..... 0±0.5 dB

RIAA Equalization Deviation

PHONO MM ..... 0±0.5 dB

Total Harmonic Distortion (20 Hz to 20 kHz)

CD/TAPE-MD/DVD-LD/TV-DBS/VCR/VIDEO

AUX to MAIN SP OUT, 40W/8 ohms

..... 0.025% or less

PHONO MM to REC OUT, 1V

..... 0.02% or less

Signal-to-Noise Ratio (IHF-A Network)

CD/TAPE-MD/DVD-LD/TV-DBS/VCR/VIDEO

AUX to SP OUT (Input Shorted 150 mV)

(EFFECT OFF) ..... 96 dB or more

PHONO MM to REC OUT

(Input Shorted 5 mV)

[U.S.A., Canada, China and General

models] ..... 86 dB or more

[Europe, U.K., Australia and Singapore

models] ..... 82 dB or more

Residual Noise (IHF-A Network)

MAIN L/R SP OUT ..... 170 µV or less

Channel Separation (Vol. -30 dB, EFFECT

OFF)

CD/TAPE-MD/DVD-LD/TV-DBS/VCR/VIDEO

AUX Input 5.1 k-ohms Shorted

1 kHz/10 kHz

..... 60/45 dB or more

PHONO MM Input Shorted

1 kHz/10 kHz

..... 60/55 dB or more

Tone Control Characteristics

Bass

Boost/Cut ..... ±10 dB (50 Hz)

Turnover frequency ..... 350 Hz

Treble

Boost/Cut ..... ±10 dB (20 kHz)

Turnover frequency ..... 3.5 kHz

Bass Extension (MAIN L/R) ..... +6 dB (50 Hz)

Filter Characteristics

MAIN L/R, CENTER, REAR L/R

(MAIN, CENTER, REAR SP: SMALL)

(H.P.F.) ..... fc = 90 Hz, 12 dB/oct.

SUBWOOFER (L.P.F.)

..... fc = 90 Hz, 18 dB/oct.

Gain Tracking Error (0 to -60 dB)

MAIN L/R ..... 3 dB or less

## VIDEO SECTION

Video Signal Type

[U.S.A. and Canada models] ..... NTSC

[Europe, U.K., Australia and Singapore

models] ..... PAL

[China and General models] ..... NTSC/PAL

Video Signal Level ..... 1 Vp-p/75 ohms

S-Video Signal Level

Y ..... 1 Vp-p/75 ohms

C ..... 0.286 Vp-p/75 ohms

Maximum Input Level ..... 1.5 Vp-p or more

Signal-to-Noise Ratio ..... 50 dB or more

Monitor Out Frequency Response

..... 5 Hz to 10 MHz, -3 dB

## FM SECTION

Tuning Range

[U.S.A. and Canada models]

..... 87.5 to 107.9 MHz

[Europe, U.K., Australia, China, Singapore

and General models] ..... 87.5 to 108.0 MHz

50 dB Quieting Sensitivity (IHF, 75 ohms,

100% mod., 1 kHz)

[U.S.A., Canada, China and General

models only]

Mono ..... 1.6 µV (15.3 dBf)

Stereo ..... 23 µV (38.5 dBf)

Usable Sensitivity (75 ohms)

[Europe, U.K., Australia and Singapore

models only]

DIN, Mono (S/N 26 dB) ..... 0.9 µV

DIN, Stereo (S/N 46 dB) ..... 28 µV

Alternate Channel Selectivity (±400 kHz)

[U.S.A., Canada, China and General

models only] ..... 75 dB

Selectivity (two signals, 40 kHz Dev. ±300

kHz)

[Europe, U.K., Australia and Singapore

models only] ..... 55 dB

Signal-to-Noise Ratio

(IHF) Mono/Stereo

[U.S.A., Canada, China and General

models] ..... 81/75 dB

(DIN-Weighted, 40 kHz Dev.) Mono/Stereo

[Europe, U.K., Australia and Singapore

models] ..... 75/69 dB

Harmonic Distortion (1 kHz)	
Mono/Stereo .....	0.1/0.2%
Stereo Separation (1 kHz) .....	48 dB
Frequency Response	
20 Hz to 15 kHz .....	0±1 dB
Output Level (100% mod., 1 kHz)	
[U.S.A., Canada, China and General models]	550 mV
[Europe, U.K., Australia and Singapore models (40 kHz Dev.)]	550 mV

## AM SECTION

Tuning Range	
[U.S.A., Canada, China and General models]	530 to 1,710 kHz
[Europe, U.K., Australia and Singapore models]	531 to 1,611 kHz

Usable Sensitivity .....	300 µV/m
Signal-to-Noise Ratio .....	52 dB
Output Level (30% mod., 1 kHz) .....	150 mV

## GENERAL

Power Supply	
[U.S.A. and Canada models]	AC 120V/60 Hz
[Europe, U.K. and Singapore models]	AC 230V/50 Hz
[Australia model]	AC 240V/50 Hz
[China and General models]	AC 110/120/220/240V, 50/60 Hz

Power Consumption	
[U.S.A. model] .....	310W
[Europe, U.K., Australia, China, Singapore and General models]	350W
[Canada model] .....	350W/440 VA

Maximum Power Consumption	
[General model only] .....	690W

AC Outlets	
2 SWITCHED OUTLETS	
[U.S.A., Europe, Canada, China, Singapore and General models] .....	100W max. total
1 SWITCHED OUTLET	
[U.K. and Australia models] .....	100W max.

Dimensions (W x H x D)	
.....	435 x 151 x 391 mm

Weight .....	13.0 kg
--------------	---------

Accessories .....	Remote controller
	Batteries
	AM loop antenna
	Indoor FM antenna

\* Specifications are subject to change without notice.

**LIST OF MANUFACTURER'S CODES  
LISTE DES CODES FABRICANTS  
VERZEICHNIS DER HERSTELLER CODES  
LISTA ÖVER TILLVERKARKODER**

**ELENCO DEI CODICI DEL FABBRICANTE  
LISTA DE CÓDIGOS DE FABRICANTES  
LIJST VAN CODES VAN FABRIKANT**

TV					
Manufacturer	Code				
Abex	0032	Contec	0216, 0009, 0036, 0157	Harvard	0068
Acura	0009	Continental Edison	0196, 0198, 0205, 0333	Hinari	0037, 0218, 0009, 0036
Admiral	0093, 0163, 0213	Crosley	0074, 0076, 0084, 0213	Hisawa	0282, 0455
Adyson	0217, 0032	Crown	0037, 0370, 0418, 0009, 0076	Hitachi	0217, 0036, 0109, 0032, 0043, 0044, 0105, 0163, 0196, 0198, 0225, 0306, 0349
Akai	0208, 0361	Crystal	0431	Huanyu	0216, 0374
Akura	0218, 0264, 0369	Curtis Mathes	0093	Hypson	0037, 0282, 0264
Alaron	0216	Cybertron	0218	ICE	0217, 0371, 0264
Alba	0037, 0218, 0371, 0009, 0036, 0235	Daewoo	0037, 0374, 0009	ICeS	0218
Allorgan	0294	Dainichi	0218, 0215	ITS	0371
Amplivision	0217	Dansai	0037	ITT	0163, 0361
Amstrad	0371, 0009, 0362, 0369	Dayton	0009	Imperial	0370, 0418, 0074, 0076, 0084, 0247
Anam	0009, 0068	De Graaf	0208	Indiana	0037
Anitech	0009, 0068, 0076	Decca	0037, 0072	Ingelen	0163
Arcam	0216, 0217	Dixi	0037, 0009	Inno Hit	0072
Asberg	0076	Dual	0336, 0352	Interbuy	0068
Asuka	0218	Dual Tec	0217	Interfunk	0037, 0163, 0247, 0361
Atlantic	0206	Dumont	0070	Intervision	0037, 0217, 0264, 0102, 0068
Audiosonic	0037, 0109	Elbe	0259	Isukai	0218
Autovox	0206, 0076, 0336	Elin	0037	JVC	0371, 0036, 0053, 0190, 0192
BPL	0282	Elite	0218, 0320	KTV	0217
BSR	0294	Elta	0009	Kaisui	0216, 0217, 0218, 0009, 0282
BTC	0218	Emerson	0282, 0213, 0361	Kamp	0216
Baird	0343	Erres	0037, 0012	Kapsch	0206, 0163
Basic Line	0218, 0009	Expert	0206	Kawasho	0216
Baur	0037, 0010, 0554, 0349, 0361	Ferguson	0037, 0109, 0005, 0073, 0190, 0238, 0287, 0335, 0343	Kendo	0037, 0235, 0362
Beko	0370	Fidelity	0216, 0361	Kingsley	0216
Beon	0037	Finlandia	0208, 0346, 0359	Kneissel	0259
Binatone	0217	Finlux	0037, 0072, 0070, 0105, 0346	Korpel	0037
Blaupunkt	0554, 0191, 0195, 0200, 0213, 0327, 0328	Firstline	0216, 0217, 0294, 0009, 0321, 0247	Koyoda	0009
Blue Sky	0218	Fisher	0370, 0217, 0208, 0303	Leyco	0037, 0294, 0072, 0264
Blue Star	0282	Flint	0455	Liesenk & Tter	0037
Bondstec	0247	Formenti	0037, 0320, 0213	Lloytron	0032
Boots	0217	Frontech	0264, 0431, 0163, 0247	Loewe	0075
Brandt	0109, 0196, 0198, 0205, 0333, 0335	Fujitsu	0072, 0206	Luma	0206
Brionvega	0362	Funai	0294, 0264, 0303	Luxor	0349, 0361
Britannia	0216	GE	0282, 0093	M Electronic	0037, 0217, 0374, 0009, 0109, 0068, 0105, 0163, 0287, 0346
Bush	0037, 0218, 0374, 0371, 0294, 0009, 0282, 0036, 0349	GEC	0037, 0217, 0072, 0043, 0205	MGA	0150
CCE	0037, 0217	GPM	0218	MTC	0216, 0349
CGE	0074, 0076, 0084, 0247, 0306	Geloso	0009, 0213	Magnadyne	0102, 0247
CS Electronics	0216	Genexxa	0218, 0163	Magnafon	0102, 0076, 0213
CTC	0247	GoldStar	0037, 0217, 0109, 0032, 0290	Magnavox	0036
Carrefour	0036	Goodmans	0037, 0217, 0374, 0371, 0072, 0036, 0235, 0317, 0343	Manesth	0217, 0320, 0264, 0235
Cascade	0009	Gorenje	0370	Marantz	0037
Cathay	0037	Gradiente	0053	Mark	0037
Centurion	0037	Graetz	0163, 0361	Matsui	0037, 0217, 0371, 0294, 0009, 0072, 0036, 0035, 0011, 0208, 0235
Century	0213	Granada	0037, 0217, 0072, 0146, 0208, 0339, 0359	Matsushita	0250
Cimline	0009	Grandin	0282	McMichael	0043
Clarivox	0037	Grundig	0037, 0554, 0070, 0191, 0195, 0205	Mediator	0037, 0012
Clatronic	0370, 0076, 0247	HCM	0009, 0282	Memorex	0009, 0250, 0150
Condor	0370, 0320	Hanseatic	0037, 0320, 0361	Memphis	0337
		Harley Davidson	0043		



Metz	0213, 0367	Realistic	0032	Texet	0216, 0218
Midland	0032	Rediffusion	0361	Thomson	0109, 0196, 0198, 0205,
Minerva	0554, 0070	Revox	0037		0287, 0333, 0343, 0349
Minoka	0369	Rex	0206, 0264, 0163, 0259	Thorn	0037, 0072, 0035, 0074,
Mitsubishi	0036, 0093, 0108, 0150	Rhapsody	0216		0084, 0190, 0192, 0361
Mivar	0216, 0290, 0291, 0292	Roadstar	0218, 0418, 0009, 0264	Thorn-Ferguson	0343
Motion	0076	SBR	0037, 0012, 0043	Tomashi	0282
Motorola	0093	SEG	0217, 0264, 0036, 0076	Toshiba	0036, 0035, 0070, 0243
Multitech	0216, 0217, 0009, 0102, 0076	SEI	0294, 0102, 0213	Trical	0157
NEC	0455, 0036	Saba	0109, 0075, 0163, 0196, 0198,	Triumph	0243
NEI	0037, 0431, 0337		0205, 0213, 0287, 0335, 0343	Uher	0206, 0320, 0303
Neckermann	0037, 0554, 0191,	Saccs	0238	Ultra	0192
	0213, 0349	Saisho	0009, 0264, 0431, 0011, 0235	Ultravox	0102
Nikkai	0037, 0216, 0218, 0072,	Salora	0163, 0349, 0359, 0361	Universum	0037, 0370, 0264,
	0264, 0035, 0032, 0337	Sambers	0102, 0076, 0213		0105, 0346
Nikko	0317	Sampo	0032	Vestel	0037
Noblisko	0102, 0076	Samsung	0037, 0370, 0217, 0009,	Victor	0053
Nokia	0361		0264, 0032, 0090, 0290	Videosat	0247
Nordmende	0109, 0196, 0198,	Sandra	0216	Videotronic	0217
	0213, 0287, 0343	Sanyo	0072, 0036, 0011, 0146, 0157,	Vidtech	0036
Oceanic	0163, 0215, 0361		0208, 0213, 0339	Vision	0320
Optimus	0250	Schaub Lorenz	0361	Voxson	0163
Optonica	0093	Schneider	0037, 0218, 0371, 0247,	Waltham	0217
Orion	0037, 0294, 0320, 0321, 0235		0303, 0323, 0336, 0352	Watson	0037, 0320
Osaki	0217, 0218, 0072, 0264, 0032	Sears	0146	Watt Radio	0102
Oso	0218	Sei-Sinudyne	0010	Wega	0036
Osume	0072, 0032, 0157	Seleco	0206, 0163, 0259, 0362	White Westinghouse	0037, 0216, 0320
Otake	0317	Sentra	0035	Yoko	0037, 0217, 0264, 0431
Otto Versand	0037, 0217, 0320, 0036,	Sharp	0036, 0093, 0157	Zanussi	0206
	0010, 0554, 0191, 0213,	Shorai	0294		
	0343, 0349	Siarem	0102, 0213		
Palladium	0370, 0418	Siemens	0037, 0554, 0157, 0191,		
Panama	0217, 0264		0195, 0200, 0213, 0327, 0328		
Panasonic	0250, 0163, 0213, 0214,	Silver	0036		
	0226, 0367	Sinudyne	0294, 0102, 0213, 0235		
Pathe Cinema	0216, 0320, 0213, 0238	Solavox	0032, 0163		
Pathe Marconi	0196, 0198, 0205, 0333	Sonitron	0208		
Pausa	0009	Sonoko	0037, 0009		
Penney	0032	Sonolor	0163, 0208, 0215		
Perdio	0320	Sontec	0037		
Phase	0032	Sony	0036, 0010, 0011		
Philco	0074, 0076, 0084, 0213, 0247	Soundwave	0037, 0418		
Philips	0037, 0374, 0554, 0012,	Standard	0217, 0218, 0009		
	0043, 0323	Stern	0206, 0163, 0259		
Phonola	0037, 0012	Sunkai	0294, 0321		
Pioneer	0109, 0163, 0287	Susumu	0218		
Profex	0009, 0076, 0361	Sysline	0037		
Proline	0321	Tandy	0217, 0218, 0072, 0093, 0163		
Protech	0037, 0217, 0418, 0009,	Tashiko	0217, 0036, 0043, 0359		
	0264, 0102, 0431, 0247, 0337	Tatung	0037, 0217, 0072		
Pye	0012	Tec	0217, 0247		
Quasar	0250	Technema	0320		
Quelle	0037, 0010, 0554, 0011,	Technics	0250		
	0070, 0074, 0084, 0200,	Teknika	0150		
	0213, 0306, 0327, 0328, 0361	Teleavia	0205, 0333, 0343		
Questa	0036	Telefunken	0109, 0005, 0074, 0084,		
R-Line	0037		0101, 0213, 0262, 0306,		
RBM	0070		0335, 0343		
RCA	0090, 0093	Telemeister	0320		
Radio Shack	0032	Teletech	0009		
Radiola	0037, 0012, 0323	Teleton	0217, 0206, 0349		
Rank Arena	0036	Tensai	0218, 0294, 0320, 0317		

---

## CABLE

Manufacturer	Code
ABC	1003, 1008, 1014, 1017
Birmingham Cable Communications	1276
British Telecom	1003, 1105
Cabletime	1161, 1271, 1377
Clyde	1086
Contec	1019
Decsat	1423
Filmnet	1443
France Telecom	1451
GEC	1086
General Instrument	1276
GoldStar	1144
Jerrold	1003, 1276, 1014
MNet	1443, 1019
Magnavox	1032
Memorex	1000
Movie Time	1156
NSC	1156
Oak	1019
PVP Stereo Visual Matrix	1003
Panasonic	1000
Paragon	1000
Pioneer	1144, 1260
Pulsar	1000
Runco	1000
STS	1156

Salora	1382	Freecom	2421, 2335	Planet	2871
Samsung	1144	Fuba	2421, 2369, 2396, 2217,	Plasmatic	2442
Satbox	1375		2297, 2417	Polytron	2394
Scientific Atlanta	1008, 1277, 1017	G-Sat	2183	Promax	2455
Starcom	1003	Galaxis	2288, 2834, 2863	Prosat	2288
Tele+1	1443	Galaxisat	2321	Quadral	2362, 2519
Teleservice	1281	GoldStar	2335	RFT	2288, 2220, 2200
Toshiba	1000	Gooding	2571	Radiola	2200
Tudi	1286	Goodmans	2189	Radix	2396, 2882
United Cable	1003	Grothusen	2335	SAT	2321, 2351, 2461
Videoway	1250	Grundig	2571, 2173, 2189, 2328	SEG	2421, 2369, 2539
Westminster	1105	Harting und Helling	2333	STVI	2417
Zenith	1000	Hinari	2183	Saba	2520, 2336

---

## DBS TUNER

Manufacturer	Code				
AST	2321, 2351			Satcom	2605, 2346
Alba	2455, 2421, 2362, 2613			Satec	2183, 2328
Aldes	2288			Satmaster	2346
Allantide	2333			Schwaiger	2183, 2394, 2504
Amstrad	2080, 2252, 2345, 2461, 2501			Seemann	2396, 2530
Ankaro	2369, 2288, 2220, 2519, 2217		2358, 2394, 2442, 2480, 2504	Siemens	2173
Antron	2421, 2183			Skymaster	2288, 2605, 2519
Arcon	2368			Star Trak	2421
Armstrong	2243			Strong	2421
Astra	2108, 2539			Sunstar	2513
Astro	2520, 2173, 2358, 2501			TPS	2820
Avalon	2396			Tantec	2455, 2297, 2336
Axis	2369, 2530			TechniSat	2262, 2501
BT	2668			Techniland	2346
Barcom	2217			Telefunken	2421
Beko	2189			Teleka	2243, 2613
Best	2369, 2217			Telesat	2605
Blaupunkt	2173			Thomson	2455
Boca	2243, 2513			Tonna	2668, 2346
Brain Wave	2332			Triad	2321, 2333, 2335, 2351
Bush	2067			Triasat	2501
CNT	2520			Unitor	2332, 2217
Cambridge	2344			Universum	2571, 2173
Channel Master	2362			Vector	2333
Chaparral	2053, 2209			Ventana	2200
CityCom	2394			Vortec	2421
Commlink	2288			Vtech	2351
Connexions	2396			Wevasat	2333
Crown	2243			Winersat	2332
Cyrus	2200			Wisi	2455, 2396, 2173, 2321, 2351, 2372, 2406, 2407
D-box	2723			XSat	2889
DDC	2362			Xcom Multimedia	2889
DNT	2396, 2200			Zehnder	2520, 2321, 2331
Diskxpress	2217				
Drake	2268				
EIF	2417				
Echostar	2396, 2871				
Emanon	2421				
FTE	2331				
Ferguson	2183, 2067, 2189, 2336				
Fidelity	2252				
Finlux	2455, 2108, 2344, 2397				
Fracarro	2871				
		Hitachi	2455		
		Houston	2668		
		Huth	2243, 2288, 2220, 2346		
		ITT	2108		
		InVideo	2871		
		Intervision	2592		
		JVC	2571		
		Johansson	2332		
		Kathrein	2173, 2200, 2092, 2331,		
			2358, 2394, 2442, 2480, 2504		
		Kosmos	2331, 2335		
		Kreiselmeier	2173		
		Kyostar	2421		
		La Sat	2520, 2513, 2464		
		Lemon	2692		
		Lenco	2421, 2335		
		Lennox	2592		
		Lupus	2369		
		Luxor	2573, 2108		
		Manhattan	2455, 2592, 2520		
		Marantz	2200		
		Maspro	2092, 2328, 2336		
		Matsui	2571, 2344		
		Mediamarkt	2243		
		Micro Technology	2333, 2539		
		Minerva	2571		
		Morgan's	2243, 2513		
		Multistar	2331, 2464		
		Muratto	2335		
		Navex	2332		
		Neuhaus	2501		
		Neusat	2692, 2834		
		Newhaus	2220		
		Nikko	2360		
		Nokia	2455, 2573, 2108, 2328,		
			2397, 2873		
		Nordmende	2362		
		Orbitech	2501		
		Oxford	2344		
		Pace	2455, 2183, 2067, 2328,		
			2336, 2791		
		Palcom	2297		
		Palladium	2571		
		Palsat	2501		
		Panda	2455		
		Philips	2455, 2571, 2200, 2292, 2328		
		Phonotrend	2288, 2592		

---

## VCR

Manufacturer	Code
ASA	3037, 3081
Admiral	3048

Adventura	3000	Finlux	3000, 3081, 3042, 3104	Magnavox	3000, 3081
Aiko	3278	Firstline	3072, 3037, 3209,	Magnin	3240
Aiwa	3000, 3037, 3307, 3348, 3352		3045, 3043	Manesth	3072, 3045
Akai	3315, 3106, 3041, 3053	Fisher	3046, 3047, 3054, 3104	Marantz	3081, 3003, 3006
Akiba	3072	Frontech		Marta	3037
Alba	3072, 3020, 3278, 3209,	Fuji	3020	Matsui	3209, 3004, 3036,
	3315, 3352	Funai	3033		3088, 3348, 3352
Ambassador	3020	GE	3000	Matsushita	3162
Amstrad	3000, 3278, 3325, 3332	GEC	3048, 3240	Memorex	3000, 3037, 3048,
Anitech	3072	Garrard	3081		3046, 3047, 3104,
Asha	3240	General	3000		3162, 3240, 3307
Asuka	3037	Go Video	3020	Memphis	3072
Audiovox	3037	GoldHand	3432	Metz	3347, 3195, 3003,
Baird	3000, 3041, 3104, 3107	GoldStar	3072		3006, 3162, 3227
Basic Line	3072, 3020, 3278	Goodmans	3037, 3038, 3225	Minerva	3195, 3006
Beaumarck	3240		3072, 3000, 3020,	Minolta	3042
Bell & Howell	3104		3037, 3278, 3403	Mitsubishi	3081, 3067, 3048, 3043
Blaupunkt	3034, 3226, 3195,	Gradiente	3000, 3008	Motorola	3048
	3003, 3006, 3154,	Graetz	3005, 3041, 3104, 3240	Multitech	3072, 3000
	3162, 3227, 3403	Granada	3081, 3046, 3104	Murphy	3000
Brandt	3320, 3187, 3321	Grandin	3072, 3000, 3037	NEC	3067, 3038, 3041, 3104
Brandt Electronic	3041	Grundig	3072, 3081, 3347, 3226,	Neckermann	3081
Broksonic	3209		3195, 3003, 3006, 3007,	Nesco	3072
Bush	3072, 3278, 3209, 3352		3207, 3349, 3403	Nikko	3037
CCE	3072, 3278	HCM	3072	Nikon	3034
CGE	3000	HI-Q	3047	Noblex	3240
Calix	3037	Hanseatic	3037	Nokia	3106, 3046, 3041, 3104, 3240
Capehart	3020	Harley Davidson	3000	Nordmende	3320, 3384, 3041,
Carver	3081	Harman/Kardon	3038		3297, 3321
Catron	3020	Harwood	3072	Oceanic	3000, 3041
Cimline	3072	Headquarter	3046	Okano	3315, 3348
Cineral	3278	Hinari	3072, 3004, 3240, 3352	Olympus	3226
Citizen	3037, 3278	Hitachi	3000, 3004, 3042, 3041,	Optimus	3037, 3432, 3048, 3104, 3162
Clatronic	3020		3166, 3235, 3240	Orion	3209, 3004, 3036,
Colt	3072	Hypson	3072		3088, 3348, 3352
Combitech	3352	ITT	3106, 3046, 3384, 3005,	Osaki	3072, 3000, 3037
Condor	3020		3041, 3104, 3240	Otto Versand	3081
Craig	3072, 3037, 3047, 3240	ITV	3037, 3278	Palladium	3072, 3037, 3006, 3041
Crown	3072, 3020, 3278	Imperial	3000	Panasonic	3226, 3162, 3225, 3227
Curtis Mathes	3041, 3162	Ingersol	3004	Pathe Cinema	3036
Cybernex	3240	Interfunk	3081	Pathe Marconi	3041
Cyrus	3081	JVC	3067, 3384, 3008, 3041,	Penney	3037, 3042, 3038, 3054, 3240
Daewoo	3020, 3278, 3045		3206, 3207, 3486	Pentax	3042
Dansai	3072	Jensen	3041	Perdio	3000
Daytron	3020	KEC	3037, 3278	Philco	3209, 3038
De Graaf	3042, 3166	KLH	3072	Philips	3081, 3384, 3403
Decca	3000, 3081	Kaisui	3072	Phonola	3081
Denon	3042	Kendo	3209, 3106	Pilot	3037
Dual	3041	Kenwood	3067, 3384, 3038, 3041	Pioneer	3081, 3067, 3162, 3235
Dumont	3000, 3081, 3104	Kodak	3037	Portland	3020
Dynatech	3000	Korpel	3072	Profex	3322
ESC	3278, 3240	LXI	3037	Profitronic	3240
Elbe	3038	Lenco	3278	Proline	3000
Elcatech	3072	Leyco	3072	Protec	3072
Electrohome	3037	Lloyd's	3000	Pye	3081
Electroponic	3037	Loewe	3037, 3004, 3081, 3006	Quarter	3046
Emerex	3032	Logik	3072, 3004, 3240	Quartz	3046
Emerson	3000, 3037, 3278, 3209,	Luxor	3106, 3048, 3046, 3043, 3104	Quasar	3162
	3036, 3043, 3088	M Electronic	3000	Quelle	3081
Ferguson	3320, 3041, 3107, 3321	MGA	3043, 3240	RCA	3106, 3042, 3048, 3240
Fidelity	3000	MGN Technology	3240	RFT	3403
Finlandia	3081, 3104	MTC	3000, 3240	Radio Shack	3000, 3037
		Magnasonic	3278		

Radiola	3081	Thorn	3036, 3041, 3104	Radiola	5388
Radix	3037	Toshiba	3081, 3045, 3384, 3041, 3043	Realistic	5203
Randex	3037	Totevision	3037, 3240	Salora	5064
Realistic	3000, 3037, 3048, 3046, 3047, 3104	Towada	3322	Sega	5023
Rex	3384, 3041	Uher	3240	Sharp	5001
Ricoh	3034	Unitech	3240	Sony	5193, 5201
Roadstar	3072, 3037, 3278, 3240	Universum	3000, 3037, 3081, 3106, 3195, 3006, 3240, 3325	Technics	5204, 5496
SBR	3081	Vector	3045	Telefunken	5059
SEG	3322, 3240	Vector Research	3038	Theta Digital	5194
SEI	3004, 3081	Video Concepts	3045	Thorn	5014
STS	3042	Videosonic	3240	Yamaha	5217
Saba	3320, 3384, 3041, 3206, 3207, 3297, 3321	Wards	3072, 3000, 3081, 3042, 3048, 3047, 3240		
Saisho	3209, 3004, 3036, 3088	White Westinghouse	3278		
Salora	3106, 3046, 3043	XR-1000	3072, 3000		
Samsung	3432, 3045, 3053, 3240	Yamaha	3038		
Sanky	3048	Yamishi	3072		
Sansui	3000, 3067, 3041	Yokan	3072		
Sanyo	3046, 3047, 3104, 3240	Yoko	3020, 3240		
Saville	3352	Zenith	3000, 3033, 3034		
Schaub Lorenz	3000, 3005, 3041, 3104				
Schneider	3072, 3000, 3081				
Scott	3045, 3043				
Sears	3000, 3037, 3042, 3046, 3047, 3054, 3104				
Seleco	3041				
Semp	3045				
Sentra	3020				
Sharp	3048				
Shintom	3072, 3104				
Shogun	3240				
Shorai	3004				
Siemens	3037, 3081, 3195, 3003, 3006, 3054, 3104				
Silva	3037				
Singer	3072, 3045				
Sinudyne	3004, 3081				
Solavox	3020				
Sonolor	3046				
Sontec	3037				
Sony	3000, 3032, 3033, 3034, 3011				
Sunkai	3348				
Sunstar	3000				
Suntronic	3000				
Sylvania	3000, 3081, 3043				
Symphonic	3000				
TMK	3036, 3240				
Tashiko	3000				
Tatung	3000, 3081, 3041				
Teac	3000, 3041				
Tec	3020				
Technics	3226, 3162				
Teknika	3000, 3037				
Televia	3041				
Telefunken	3320, 3384, 3041, 3187, 3321				
Tenosal	3072				
Tensai	3322, 3000				
Thomas	3000				
Thomson	3320, 3384, 3041				

---

## CD PLAYER

Manufacturer	Code
Aiwa	6124, 6157, 6419
Akai	6108, 6156, 6199
Alba	6536, 6288, 6334
Arcam	6157
Audio Research	6157
Audio Ton	6157
Audiolab	6157
Audiomeca	6157
BSR	6134
Bestar	6164
Binatone	6452
California Audio Lab	6029
Carver	6157, 6179
Condor	6134, 6164
Cyrus	6157
DKK	6000
Denon	6003, 6034
Dual	6196
Emerson	6164
Fisher	6048, 6179, 6342
GE	6334
Genexxa	6032, 6164
GoldStar	6525, 6383
Goodmans	6536
Grundig	6157
Harman/Kardon	6108, 6173
Hitachi	6032, 6291
JVC	6072
Kenwood	6037, 6523, 6028, 6048, 6190
Kodak	6287
Krell	6157
Linn	6157
Luxman	6328
M Electronic	6525
MCS	6029
Magnavox	6157, 6038, 6129
Marantz	6157, 6029, 6038, 6129
Matsui	6157, 6288, 6307
McIntosh	6287
Memorex	6032, 6164
Meridian	6157
Micromega	6157
Mission	6157
Mitsubishi	6108, 6156

---

## DVD PLAYER

Manufacturer	Code
Kenwood	4534
Magnavox	4503
Onkyo	4503
Panasonic	4490
Philips	4539, 4503
Pioneer	4525
Sony	4533
Technics	4490
Thomson	4551
Toshiba	4503
Yamaha	4490, 4545
Zenith	4503

---

## LD PLAYER

Manufacturer	Code
Aiwa	5203
Carver	5064, 5194
Cyrus	5388
Denon	5059, 5172
Disco Vision	5023
Funai	5203
Hitachi	5023
Magnavox	5194, 5217
Marantz	5064, 5194
Mitsubishi	5059
NAD	5059
Panasonic	5204, 5496
Philips	5064, 5388, 5194
Pioneer	5023, 5059
Quasar	5204

NAD	6000	Kenwood	8070, 8071, 8092,
NSM	6157		8205, 8233, 8234
Naim	6157	Magnavox	8029
Nikko	6525, 6164	Marantz	8029, 8009
Onkyo	6101, 6102	Memorex	8099, 8101
Optimus	6000, 6032, 6037, 6536,	Mitsubishi	8189
	6048, 6179, 6196, 6342	Onkyo	8136, 8135
Panasonic	6303, 6029, 6367	Optimus	8027, 8220
Philips	6157, 6274, 6287	Panasonic	8229
Pioneer	6032	Philips	8029
Poppy	6164	Pioneer	8027, 8099, 8101, 8220
Proton	6157	Revox	8029
QED	6157	Sansui	8029, 8009
Quad	6157	Sanyo	8074
Quasar	6029	Sharp	8205
RCA	6179	Sony	8170, 8243
Realistic	6164, 6179	Technics	8229
Revox	6157, 6113	Victor	8273, 8274
Roadstar	6461, 6525, 6527	Wards	8027
Rotel	6157	Yamaha	8094, 8097, 8205, 8478, 8524
SAE	6157		
Sansui	6157, 6202, 6513		
Sanyo	6048, 6179, 6342		
Schneider	6134		
Scott	6164		
Sharp	6037, 6262, 6265		
Sherwood	6114, 6196		
Siemens	6516		
Signature	6108		
Sony	6000, 6490		
Teac	6378		
Technics	6207, 6303, 6029		
Toshiba	6481		
Universum	6157		
Victor	6072		
Wards	6157, 6108		
Yamaha	6036, 6082, 6187, 6712		
Yorx	6461		

---

## MD RECORDER

Manufacturer	Code
Kenwood	7826
Sony	7490
Yamaha	7888, 7490

---

## TAPE DECK

Manufacturer	Code
Aiwa	8029, 8197, 8200
Akai	8188, 8189
Arcam	8076
Carver	8029
Denon	8076, 8412
Fisher	8074
Grundig	8029
Harman/Kardon	8182
JVC	8244, 8273, 8274



---

YAMAHA ELECTRONICS CORPORATION, USA 6660 ORANGETHORPE AVE., BUENA PARK, CALIF. 90620, U.S.A.  
YAMAHA CANADA MUSIC LTD. 135 MILNER AVE., SCARBOROUGH, ONTARIO M1S 3R1, CANADA  
YAMAHA ELECTRONIK EUROPA G.m.b.H. SIEMENSSTR. 22-34, 25462 RELINGEN BEI HAMBURG, F.R. OF GERMANY  
YAMAHA ELECTRONIQUE FRANCE S.A. RUE AMBROISE CROIZAT BP70 CROISSY-BEAUBOURG 77312 MARNE-LA-VALLEE CEDEX02, FRANCE  
YAMAHA ELECTRONICS (UK) LTD. YAMAHA HOUSE, 200 RICKMANSWORTH ROAD WATFORD, HERTS WD1 7JS, ENGLAND  
YAMAHA SCANDINAVIA A.B. J A WETTERGRENS GATA 1, BOX 30053, 400 43 VÄSTRA FRÖLUNDA, SWEDEN  
YAMAHA MUSIC AUSTRALIA PTY, LTD. 17-33 MARKET ST., SOUTH MELBOURNE, 3205 VIC., AUSTRALIA

YAMAHA CORPORATION

Printed in Malaysia  V416020

# Quick Reference Card

## AMP/TUN

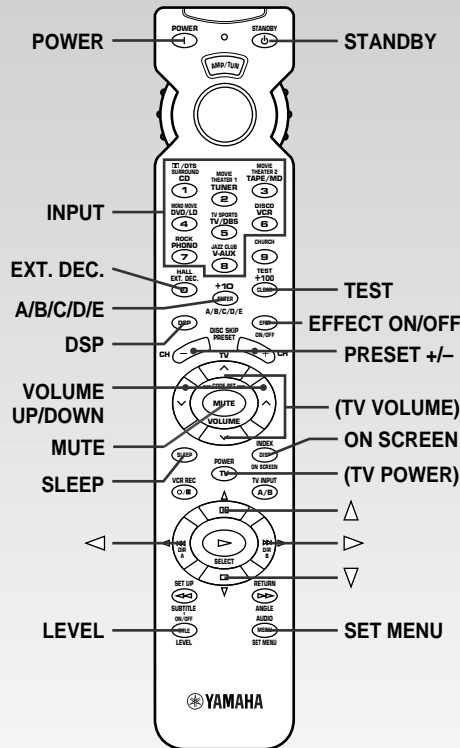

## TAPE/MD

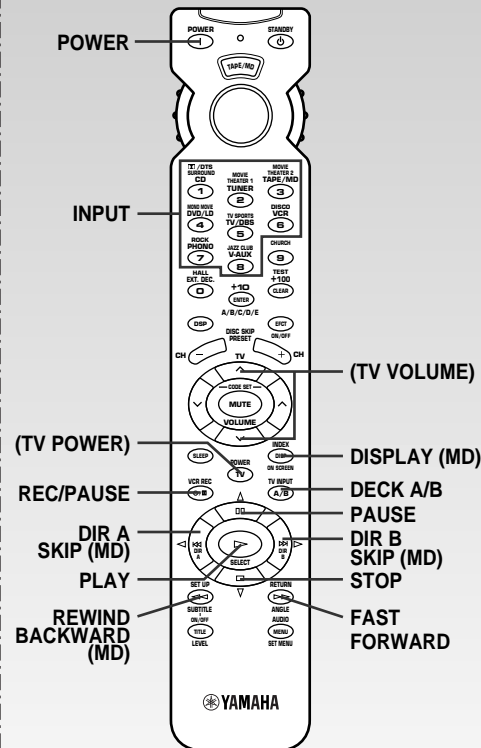

## CD

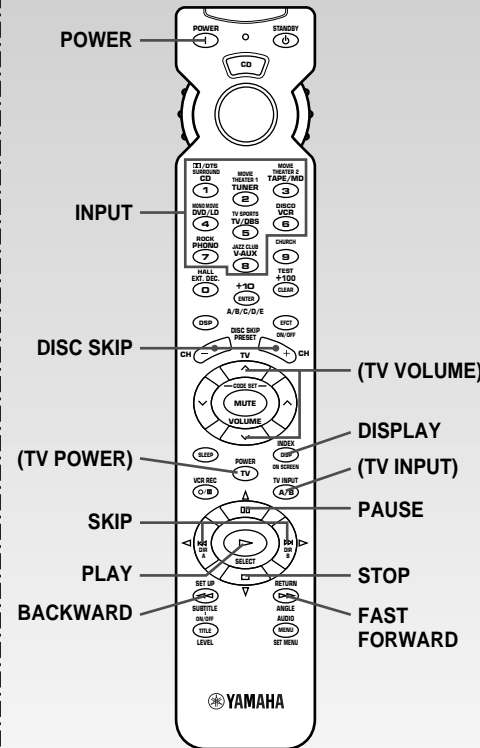

## DVD/LD

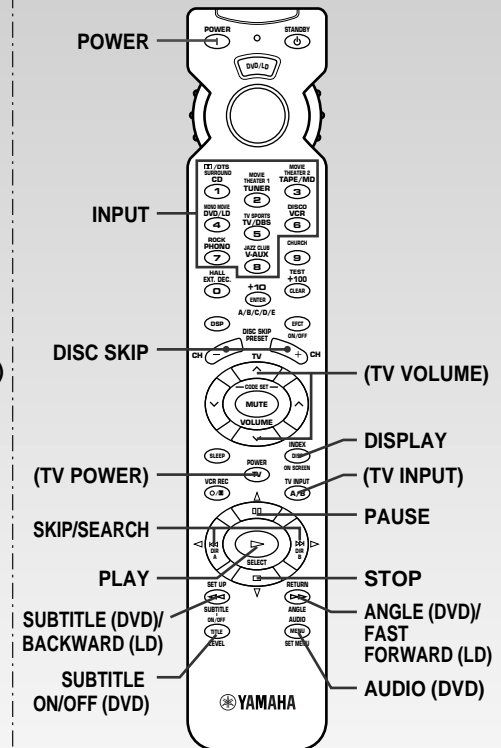

## DSP

