

ARIUS

YDP-181

Owner's Manual

Mode d'emploi

Manual de Instrucciones

ENGLISH

FRANÇAIS

ESPAÑOL

For information on assembling the keyboard stand, refer to the instructions at the end of this manual.

IMPORTANT — Check your power supply —

Make sure that your local AC mains voltage matches the voltage specified on the name plate on the bottom panel. In some areas a voltage selector may be provided on the bottom panel of the main keyboard unit near the power cord. Make sure that the voltage selector is set for the voltage in your area. The voltage selector is set at 240V when the unit is initially shipped.

To change the setting use a "minus" screwdriver to rotate the selector dial so that the correct voltage appears next to the pointer on the panel.

Pour obtenir des informations sur l'assemblage du support du clavier, reportez-vous aux instructions à la fin de ce manuel.

IMPORTANT — Contrôler la source d'alimentation —

Vérifiez que la tension spécifiée sur le panneau inférieur correspond à la tension du secteur. Dans certaines régions, l'instrument peut être équipé d'un sélecteur de tension situé sur le panneau inférieur du clavier à proximité du cordon d'alimentation.

Vérifiez que ce sélecteur est bien réglé en fonction de la tension secteur de votre région. Le sélecteur de tension est réglé sur 240 V au départ d'usine. Pour modifier ce réglage, utilisez un tournevis à lame plate pour tourner le sélecteur afin de mettre l'indication correspondant à la tension de votre région vis à vis du repère triangulaire situé sur le panneau.

Para información sobre el montaje del soporte del teclado, consulte las instrucciones al final de este manual.

IMPORTANTE — Verifique la alimentación de corriente —

Asegúrese de que tensión de alimentación de CA de su área corresponde con la tensión especificada en la placa de características del panel inferior. En algunas zonas puede haberse incorporado un selector de tensión en el panel inferior de la unidad del teclado principal, cerca del cable de alimentación. Asegúrese de que el selector de tensión esté ajustado a la tensión de su área. El selector de tensión se ajusta a 240V cuando la unidad sale de fábrica. Para cambiar el ajuste, emplee un destornillador de cabeza "recta" para girar el selector de modo que aparezca la tensión correcta al lado del indicador del panel.

EN
FR
ES

SPECIAL MESSAGE SECTION

PRODUCT SAFETY MARKINGS: Yamaha electronic products may have either labels similar to the graphics shown below or molded/stamped facsimiles of these graphics on the enclosure. The explanation of these graphics appears on this page. Please observe all cautions indicated on this page and those indicated in the safety instruction section.

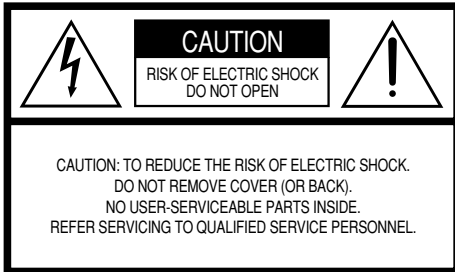

See bottom of Keyboard enclosure for graphic symbol markings.



The exclamation point within the equilateral triangle is intended to alert the user to the presence of important operating and maintenance (servicing) instructions in the literature accompanying the product.



The lightning flash with arrowhead symbol, within the equilateral triangle, is intended to alert the user to the presence of uninsulated “dangerous voltage” within the product’s enclosure that may be of sufficient magnitude to constitute a risk of electrical shock.

IMPORTANT NOTICE: All Yamaha electronic products are tested and approved by an independent safety testing laboratory in order that you may be sure that when it is properly installed and used in its normal and customary manner, all foreseeable risks have been eliminated. DO NOT modify this unit or commission others to do so unless specifically authorized by Yamaha. Product performance and/or safety standards may be diminished. Claims filed under the expressed warranty may be denied if the unit is/has been modified. Implied warranties may also be affected.

SPECIFICATIONS SUBJECT TO CHANGE: The information contained in this manual is believed to be correct at the time of printing. However, Yamaha reserves the right to change or modify any of the specifications without notice or obligation to update existing units.

ENVIRONMENTAL ISSUES: Yamaha strives to produce products that are both user safe and environmentally friendly. We sincerely believe that our products and the production methods used to produce them, meet these goals. In keeping with both the letter and the spirit of the law, we want you to be aware of the following:

Battery Notice: This product MAY contain a small non-rechargeable battery which (if applicable) is soldered in place. The average life span of this type of battery is approximately five years. When replacement becomes necessary, contact a qualified service representative to perform the replacement.

Warning: Do not attempt to recharge, disassemble, or incinerate this type of battery. Keep all batteries away from children. Dispose of used batteries promptly and as regulated by applicable laws. Note: In some areas, the servicer is required by law to return the defective parts. However, you do have the option of having the servicer dispose of these parts for you.

Disposal Notice: Should this product become damaged beyond repair, or for some reason its useful life is considered to be at an end, please observe all local, state, and federal regulations that relate to the disposal of products that contain lead, batteries, plastics, etc.

NOTICE: Service charges incurred due to lack of knowledge relating to how a function or effect works (when the unit is operating as designed) are not covered by the manufacturer’s warranty, and are therefore the owners responsibility. Please study this manual carefully and consult your dealer before requesting service.

NAME PLATE LOCATION: The graphic below indicates the location of the name plate. The model number, serial number, power requirements, etc., are located on this plate. You should record the model number, serial number, and the date of purchase in the spaces provided below and retain this manual as a permanent record of your purchase.

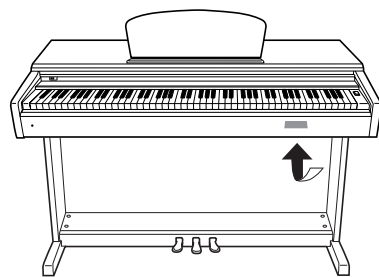

YDP-181

Model _____

Serial No. _____

Purchase Date _____

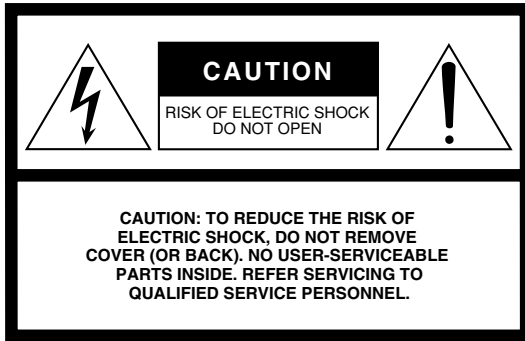

The above warning is located on the bottom of the unit.

Explanation of Graphical Symbols

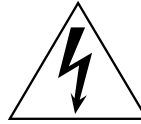

The lightning flash with arrowhead symbol within an equilateral triangle is intended to alert the user to the presence of uninsulated “dangerous voltage” within the product’s enclosure that may be of sufficient magnitude to constitute a risk of electric shock to persons.



The exclamation point within an equilateral triangle is intended to alert the user to the presence of important operating and maintenance (servicing) instructions in the literature accompanying the product.

IMPORTANT SAFETY INSTRUCTIONS

- 1 Read these instructions.
- 2 Keep these instructions.
- 3 Heed all warnings.
- 4 Follow all instructions.
- 5 Do not use this apparatus near water.
- 6 Clean only with dry cloth.
- 7 Do not block any ventilation openings. Install in accordance with the manufacturer’s instructions.
- 8 Do not install near any heat sources such as radiators, heat registers, stoves, or other apparatus (including amplifiers) that produce heat.
- 9 Do not defeat the safety purpose of the polarized or grounding-type plug. A polarized plug has two blades with one wider than the other. A grounding type plug has two blades and a third grounding prong. The wide blade or the third prong are provided for your safety. If the provided plug does not fit into your outlet, consult an electrician for replacement of the obsolete outlet.
- 10 Protect the power cord from being walked on or pinched particularly at plugs, convenience receptacles, and the point where they exit from the apparatus.
- 11 Only use attachments/accessories specified by the manufacturer.

- 12 Use only with the cart, stand, tripod, bracket, or table specified by the manufacturer, or sold with the apparatus. When a cart is used, use caution when moving the cart/apparatus combination to avoid injury from tip-over.



- 13 Unplug this apparatus during lightning storms or when unused for long periods of time.
- 14 Refer all servicing to qualified service personnel. Servicing is required when the apparatus has been damaged in any way, such as power-supply cord or plug is damaged, liquid has been spilled or objects have fallen into the apparatus, the apparatus has been exposed to rain or moisture, does not operate normally, or has been dropped.

WARNING

TO REDUCE THE RISK OF FIRE OR ELECTRIC SHOCK, DO NOT EXPOSE THIS APPARATUS TO RAIN OR MOISTURE.

(UL60065_03)

PRECAUTIONS

PLEASE READ CAREFULLY BEFORE PROCEEDING

* Please keep this manual in a safe place for future reference.



WARNING

Always follow the basic precautions listed below to avoid the possibility of serious injury or even death from electrical shock, short-circuiting, damages, fire or other hazards. These precautions include, but are not limited to, the following:

Power supply/Power cord

- Do not place the power cord near heat sources such as heaters or radiators, and do not excessively bend or otherwise damage the cord, place heavy objects on it, or place it in a position where anyone could walk on, trip over, or roll anything over it. Batteries together with old ones.
- Only use the voltage specified as correct for the instrument. The required voltage is printed on the name plate of the instrument.
- Use only the supplied power cord/plug.
- Check the electric plug periodically and remove any dirt or dust which may have accumulated on it.

Do not open

- This instrument contains no user-serviceable parts. Do not open the instrument or attempt to disassemble or modify the internal components in any way. If it should appear to be malfunctioning, discontinue use immediately and have it inspected by qualified Yamaha service personnel.

Water warning

- Do not expose the instrument to rain, use it near water or in damp or wet conditions, or place containers on it containing liquids which might spill into any openings. If any liquid such as water seeps into the instrument, turn off the power immediately and unplug the power cord from the AC outlet. Then have the instrument inspected by qualified Yamaha service personnel.
- Never insert or remove an electric plug with wet hands.

Fire warning

- Do not put burning items, such as candles, on the unit. A burning item may fall over and cause a fire.

If you notice any abnormality

- When one of the following problems occur, immediately turn off the power switch and disconnect the electric plug from the outlet. Then have the device inspected by Yamaha service personnel.
 - The power cord or plug becomes frayed or damaged.
 - It emits unusual smells or smoke.
 - Some object has been dropped into the instrument.
 - There is a sudden loss of sound during use of the instrument.



CAUTION

Always follow the basic precautions listed below to avoid the possibility of physical injury to you or others, or damage to the instrument or other property. These precautions include, but are not limited to, the following:

Power supply/Power cord

- Do not connect the instrument to an electrical outlet using a multiple-connector. Doing so can result in lower sound quality, or possibly cause overheating in the outlet.
- When removing the electric plug from the instrument or an outlet, always hold the plug itself and not the cord. Pulling by the cord can damage it.
- Remove the electric plug from the outlet when the instrument is not to be used for extended periods of time, or during electrical storms.

Assembly

- Read carefully the attached documentation explaining the assembly process. Failure to assemble the instrument in the proper sequence might result in damage to the instrument or even injury.

Location

- Do not place the instrument in an unstable position where it might accidentally fall over.
- Before moving the instrument, remove all connected cables.
- When setting up the product, make sure that the AC outlet you are using is easily accessible. If some trouble or malfunction occurs, immediately turn off the power switch and disconnect the plug from the outlet. Even when the power switch is turned off, electricity is still flowing to the product at the minimum level. When you are not using the product for a long time, make sure to unplug the power cord from the wall AC outlet.

Connections

- Before connecting the instrument to other electronic components, turn off the power for all components. Before turning the power on or off for all components, set all volume levels to minimum.
- Be sure to set the volumes of all components at their minimum levels and gradually raise the volume controls while playing the instrument to set the desired listening level.

Handling caution

- Do not insert a finger or hand in any gaps on the key cover or instrument. Also take care that the key cover does not pinch your finger.
- Never insert or drop paper, metallic, or other objects into the gaps on the key cover, panel or keyboard.
- Do not rest your weight on, or place heavy objects on the instrument, and do not use excessive force on the buttons, switches or connectors.
- Do not use the instrument/device or headphones for a long period of time at a high or uncomfortable volume level, since this can cause permanent hearing loss. If you experience any hearing loss or ringing in the ears, consult a physician.

Using the bench (If included)

- Do not place the bench in an unstable position where it might accidentally fall over.
- Do not play carelessly with or stand on the bench. Using it as a tool or stepladder or for any other purpose might result in accident or injury.
- Only one person should sit on the bench at a time, in order to prevent the possibility of accident or injury.
- If the bench screws become loose due to extensive long-term use, tighten them periodically using the included tool.

Yamaha cannot be held responsible for damage caused by improper use or modifications to the instrument, or data that is lost or destroyed.

Always turn the power off when the instrument is not in use.

NOTICE

To avoid the possibility of damage to the product, data or other property, follow the notices below.

■ **Handling and Maintenance**

- Do not use the instrument in the vicinity of a TV, radio, stereo equipment, mobile phone, or other electric devices. Otherwise, the instrument, TV, or radio may generate noise.
- Do not expose the instrument to excessive dust or vibrations, or extreme cold or heat (such as in direct sunlight, near a heater, or in a car during the day) to prevent the possibility of panel disfiguration or damage to the internal components.
- Do not place vinyl, plastic or rubber objects on the instrument, since this might discolor the panel or keyboard.
- When cleaning the instrument, use a soft, dry or slightly damp cloth. Do not use paint thinners, solvents, cleaning fluids, or chemical-impregnated wiping cloths.
- During extreme changes in temperature or humidity, condensation may occur and water may collect on the surface of the instrument. If water is left, the wooden parts may absorb the water and be damaged. Make sure to wipe any water off immediately with a soft cloth.

■ **Saving data**

- Saved data may be lost due to malfunction or incorrect operation. Save important data to a USB storage device/external device such as a computer.
- To protect against data loss through media damage, we recommend that you save your important data onto two USB storage devices.

The serial number of this product may be found on the bottom of the unit. You should note this serial number in the space provided below and retain this manual as a permanent record of your purchase to aid identification in the event of theft.

Model No.

Serial No.

(bottom)

Thank you for purchasing the Yamaha Digital Piano! We recommend that you read this manual carefully so that you can fully take advantage of the advanced and convenient functions.

We also recommend that you keep this manual in a safe and handy place for future reference.

About this Owner's Manual and Data List

The documentation and reference materials for this instrument consist of the following:

Owner's Manual (this book)

■ Introduction

Please read this section first.

■ Reference

This section explains how to make detailed settings for the Digital Piano various functions.

■ Appendix

This section introduces reference material.

Online Materials (Downloadable from the web)

The following instructional materials are available for downloading from the Yamaha Manual Library. Access the Yamaha Manual Library, then enter your model name (YDP-181, for example) in the Model Name area to search the manuals.

<http://www.yamaha.co.jp/manual/>



Data List

The Data List contains MIDI related information, such as the MIDI Data Format and MIDI Implementation chart.



MIDI Basics (only in English, French, German and Spanish)

If you want to know more about MIDI and how to use it, refer to this introductory book.

Information

■ About copyrights

- Copying of the commercially available musical data including but not limited to MIDI data and/or audio data is strictly prohibited except for your personal use.
- This product incorporates and bundles computer programs and contents in which Yamaha owns copyrights or with respect to which it has license to use others' copyrights. Such copyrighted materials include, without limitation, all computer software, style files, MIDI files, WAVE data, musical scores and sound recordings. Any unauthorized use of such programs and contents outside of personal use is not permitted under relevant laws. Any violation of copyright has legal consequences. DON'T MAKE, DISTRIBUTE OR USE ILLEGAL COPIES.

■ About functions/data bundled with the instrument

- Some of the preset songs have been edited for length or arrangement, and may not be exactly the same as the original.

■ About this manual

- The illustrations as shown in this manual are for instructional purposes only, and may appear somewhat different from those on your instrument.
- Windows is a registered trademark of Microsoft® Corporation in the United States and other countries.
- The company names and product names in this manual are the trademarks or registered trademarks of their respective companies.

Features

GH (Graded Hammer) keyboard

A special Graded Hammer keyboard feature graded key weight and response throughout the keyboard range. They respond to a heavier touch in the low range of the keyboard and a lighter touch in the higher range of the keyboard, thus providing natural grand-piano type playability.

The Graded Hammer keyboard also offers superb playability for tremolo and other repetitive-striking techniques.

AWM Dynamic Stereo Sampling

This digital piano offers a rich and versatile range of sounds, which are created using Yamaha's proprietary sampling tone-generation system, "AWM Dynamic Stereo Sampling."

AWM (Advanced Wave Memory) is a sampling system that creates sounds close to those of an acoustic instrument by digitally recording the sounds of an instrument and applying high-quality digital filtering technology to the recorded audio samples.

The sound waveform created by an acoustic piano differs depending on the player's strength of touch, from pianissimo to fortissimo.

AWM Dynamic Stereo Sampling can create extremely dynamic nuances by recording samples at various playing strengths. The greater the number of samples used, the greater the resulting expressiveness of the instrument.

The piano voice "Grand Piano 1" features a totally new sample recorded from a full-size concert grand piano. Each note in the sample has been adjusted meticulously so that the digital piano will play only the very best piano sounds.

The piano voices are well-separated sounds featuring a fast attack and a satisfying response.

The "Grand Piano 1" voice features multiple wave samples for different velocities (Dynamic Sampling). That is, different samples are used depending on how fast or strong the player strikes the keys. Therefore, this voice expresses detailed dynamics and sounds much closer to those of a true acoustic piano.

Accessories

- "50 greats for the Piano" (Music Book)
- Owner's Manual
- Bench
 - A bench may be included or optional, depending on your locale.
- AC Power cord
- My Yamaha Product User Registration
 - The PRODUCT ID on the sheet will be needed when you fill out the User Registration form.

■ Tuning

Unlike an acoustic piano, this instrument does not need to be tuned. It always stays perfectly in tune.

■ Transporting

If you move to another location, you can transport this instrument along with your other belongings. You can move the unit as it is (assembled) or you can disassemble the unit.

Transport the keyboard horizontally. Do not lean it up against a wall or stand it up on its side. Do not subject the instrument to excessive vibration or shock.

Table of Contents

Introduction

About this Owner's Manual and Data List.....	6
Accessories.....	7
Panel Controls and Terminals.....	10
Before Using the Digital Piano.....	12
Key Cover.....	12
Music Rest.....	12
Turning the Power On.....	13
Setting the Volume.....	14
Using Headphones.....	14
Using the Speaker Switch.....	14

Reference

Listening to the Demonstration Tunes.....	15
Listening to 50 Piano Preset Songs.....	16
Practicing a One-Hand Part Using the 50 Preset Songs (Part Cancel Function).....	17
A-B Repeat for 50 Preset Songs.....	18
Selecting & Playing Voices.....	19
Selecting Voices.....	19
Using the Pedals.....	20
Adding Variations to the Sound — [BRILLIANCE]/[REVERB]/[EFFECT]/[DAMPER RES.].....	21
Touch Sensitivity — [TOUCH].....	23
Transposition — [TRANSCOPE].....	24
Combining Two Voices (Dual mode).....	25
Using the Metronome.....	26
Recording Your Performance.....	27
Recording a performance quickly.....	27
Playing back a recorded song.....	29
Re-recording a previously recorded song.....	29
Recording to RIGHT/LEFT parts.....	30
Deleting Recorded Performance Data.....	31
Changing the Initial Settings (Data recorded at the beginning of a song).....	32
Handling Songs with a USB Storage Device.....	33
About Save and Load.....	33
Saving a Song.....	34
Loading a Song.....	35
Deleting Song Files.....	36
Formatting the USB Storage Device.....	37
Handling the USB Storage Device (USB Flash Memory).....	38
Playing Back Songs.....	40
Playing Back User/External Songs on the Instrument.....	41
Playing Back User Songs from a USB Storage Device.....	42
Useful Playback Functions.....	42

Detailed Settings — [FUNCTION] 43
 Basic Procedure in Function44
 About Each Function.....45
 F1. Fine Tuning of the Pitch.....45
 F2. Selecting a Scale45
 F3. Dual Mode Functions.....46
 F4. Other Functions.....47
 F5. Metronome Volume.....47
 F6. MIDI Functions48
 F7. Backup Functions50
 F7.5 Character Code50
Connections..... 51
 Connectors51
 Connecting a Personal Computer52
Transmitting Song Data between the Computer and the Instrument..... 53
 Loading Song Data from a Computer to the Instrument.....53
 Transmitting Song Data from the Instrument to a Computer53
Backing up Data and Initializing the data 54
 Data Backup54
 Initializing the data54
Message List 55
Troubleshooting 56
Options 56
Preset Voice List 57
Demo Song List 57
Keyboard Stand Assembly 58
Index..... 62

Appendix

Specifications / Caractéristiques techniques /Especificaciones 64
 Factory Setting List / Liste des réglages / Lista de ajustes de fábrica..... 65

Panel Controls and Terminals

ENGLISH

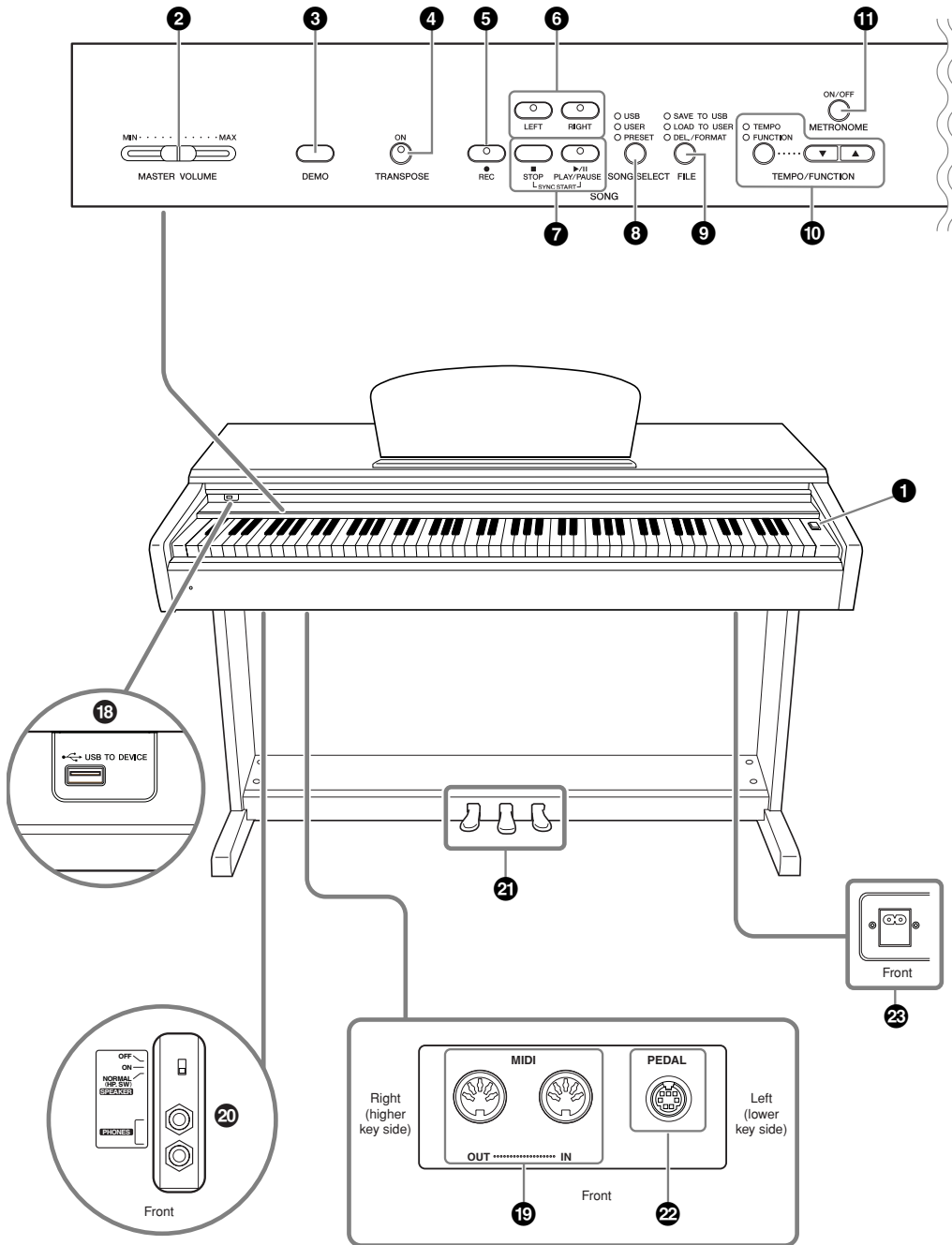

Shows the jacks as seen when viewed from below the instrument.

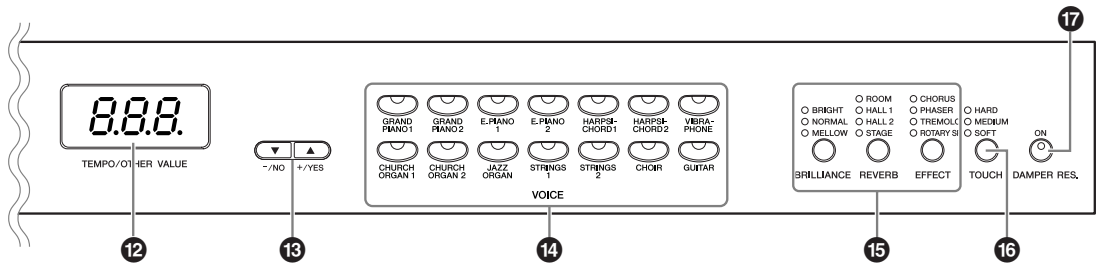

- ❶ [⏻] Power switch page 13
This switch turns the power to the unit on (▲) or off (■).
- ❷ [MASTER VOLUME] slider.....page 14
Adjust the volume level using this slider.
- ❸ [DEMO] buttonpage 15
Demonstration playback is available for each voice.
- ❹ [TRANSPOSE] button..... page 24
You can shift the pitch of the entire keyboard up or down so that the pitch will match that of another instrument or singer, while you play the same, unshifted keys.
- ❺ [REC] buttonpage 27
For recording your keyboard performance.
- ❻ [RIGHT], [LEFT] buttons..... pages 17, 30
For turning the left- and right-hand parts on or off as required so you can practice the corresponding part (the part that is turned off) on the keyboard.
- ❼ [PLAY/PAUSE], [STOP] buttons pages 16, 41
For playing back the preset songs or your recorded songs, etc.
- ❽ [SONG SELECT] button page 16
For selecting a song to play back or edit.
- ❾ [FILE] button pages 34, 37
For saving songs to and loading songs from a USB storage device, as well as managing song files. Also, lets you format a USB storage device.
- ❿ [TEMPO/FUNCTION] button ... pages 26, 44
For changing the song tempo (speed) and selecting other useful functions (pages 43 – 50).
- ⓫ [METRONOME] button..... pages 26, 47
For using the metronome.
- ⓬ Display.....page 13
Notice
Do not turn off the power to the instrument while flashing dashes appear in the display (indicating the operation is in process). Doing so may damage the data.
- ⓭ [-/NO], [+/YES] buttons
For setting values or performing file operations. Pressing both buttons simultaneously for certain value settings (Transpose, Tempo, etc.) restores the default value.
- ⓮ Voice group buttons..... page 19
For selecting voices from 14 internal sounds including Grand Piano 1 and 2. You can also combine two voices and use them together.
- ⓯ [BRILLIANCE], [REVERB], [EFFECT] buttons page 21
For adjusting the brightness of the sound and adding reverb effects to the sound.
- ⓰ [TOUCH] button page 23
For adjusting the touch response.
- ⓱ [DAMPER RES.] button page 22
For turning the Damper Resonance function on or off. When DAMPER RES. is on, the instrument simulates the sustain sound that occurs when you press the damper pedal of a grand piano, as you press the damper pedal and play the keyboard.
- ⓲ USB [TO DEVICE] terminals..... page 51
For connecting the instrument to a USB storage device, allowing saving/loading of data to and from the connected device.
- ⓳ MIDI [IN] [OUT] terminals..... page 51
For connecting external MIDI devices, allowing the use of various MIDI functions.
- ⓴ [PHONES] jacks, [SPEAKER] switch .. page 14
For connecting a set of standard stereo headphones, allowing private practice. The [SPEAKER] switch turns the internal speakers on or off.
- ⓵ PEDALS..... page 20
For producing a range of expressive effects similar to those produced by the pedals on an acoustic piano. The left pedal can also be assigned to a variety of functions.
- ⓶ [PEDAL] jack page 60
For connecting a pedal cable.
- ⓷ [AC IN] jackpages 13, 60
For connecting the included power cord.

Before Using the Digital Piano

Key Cover

To open the key cover:

Lift the cover slightly, then push and slide it open.

To close the key cover:

Slide the cover toward you and gently lower the cover over the keys.

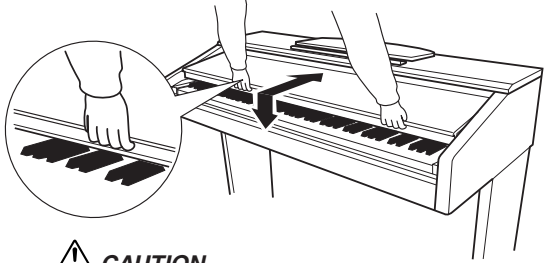

CAUTION

Be careful to avoid catching your fingers when opening or closing the cover.

CAUTION

Be careful not to pinch your fingers or the fingers of child when opening or closing it.

CAUTION

Do not place objects such as a piece of metal or paper on top of the key cover. Small objects placed on the key cover may fall inside the unit when the cover is opened and may be nearly impossible to remove. This could cause electric shock, short circuit, fire or other serious damage to the instrument.

Notice

Disconnect the optional USB storage device connected to the USB [TO DEVICE] A terminal before closing the key cover. Closing the cover with the device still connected may damage the device.

Music Rest

To raise the music rest:

1. Pull the music rest up and toward yourself as far as it will go.
2. Flip down the two metal supports at the left and right on the rear of the music rest.
3. Lower the music rest so that it rests on the metal supports.

To lower the music rest:

1. Pull the music rest toward yourself as far as it will go.
2. Raise the two metal supports (at the rear of the music rest).
3. Gently lower the music rest backward until it is all the way down.

CAUTION

Do not try to use the music rest in a half-raised position. When lowering the music rest, do not release your hands from the music rest until it is all the way down.

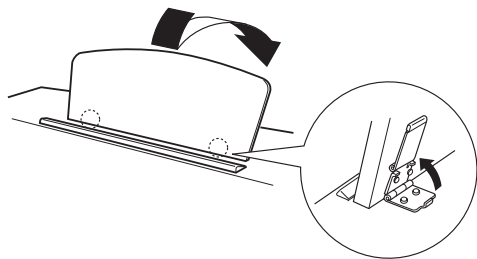
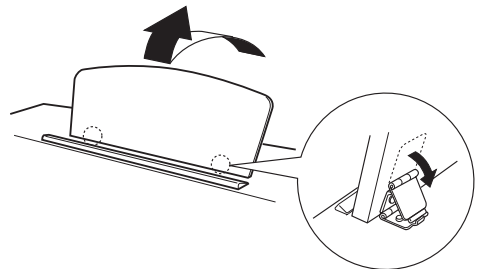

Turning the Power On

1. Connect the power cord.

Insert the plugs at the ends of the cord, one into the AC IN on the instrument, and the other into a standard AC outlet. In some areas, a plug adaptor may be provided to match the pin configuration of the AC wall outlets in your area.

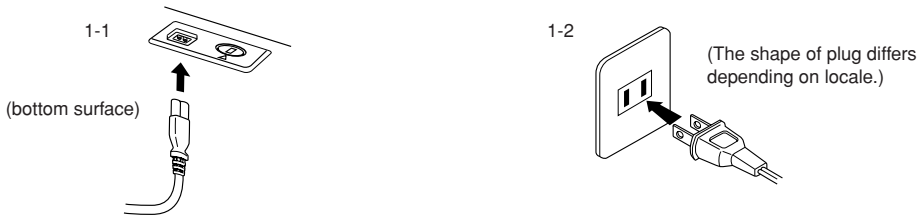

! WARNING

Make sure your instrument is rated for the AC voltage supplied in the area in which it is to be used (voltage rating appears on the name plate on the bottom panel). In some areas, a voltage selector may be provided on the bottom panel of the main keyboard unit near the AC IN. Make sure that the voltage selector is set for the voltage in your area. Connecting the unit to the wrong AC supply can cause serious damage to the internal circuitry and may even pose a shock hazard! Use only the AC power cord supplied with the instrument. If the supplied cord is lost or damaged and needs to be replaced, contact your Yamaha dealer. The use of an inappropriate replacement can pose a fire and shock hazard! The type of AC power cord provided with the instrument may be different depending on the country in which it is purchased. (In some areas a plug adaptor may be provided to match the pin configuration of the AC wall outlets in your area.) Do NOT modify the plug provided with the instrument. If the plug will not fit the outlet, have a proper outlet installed by a qualified electrician.

2. Turn the power on.

Press the [⏻] Power switch

- The display located in the center of the front panel and the power indicator located below the left end of the keyboard lights up.

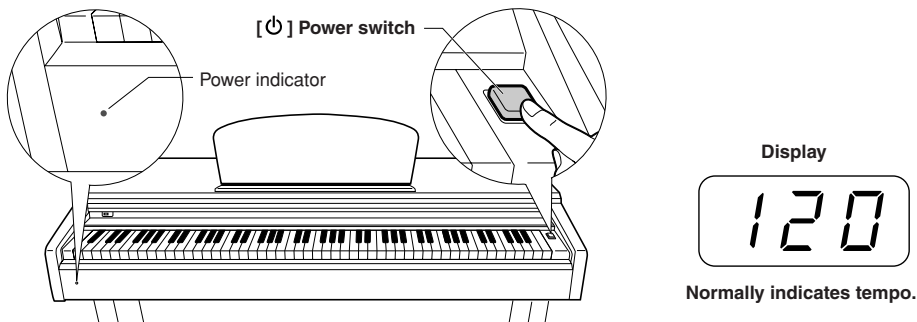

When you're ready to turn off the power, press the [⏻] Power switch again.

- The display and the power indicator turn off.

NOTE

Power indicator

If you close the key cover without turning the power off, the power indicator remains lit, indicating that the power is still on.

! CAUTION

A small amount of electrical current remains even after the [⏻] switch has been turned off.

If you plan not to use the instrument for an extended period of time, or if there is a possibility of lightning, be sure to unplug the instrument from the AC outlet.

Setting the Volume

Initially set the [MASTER VOLUME] slider about halfway between the “MIN” and “MAX” settings. Then, when you start playing, re-adjust the [MASTER VOLUME] slider to the most comfortable listening level.

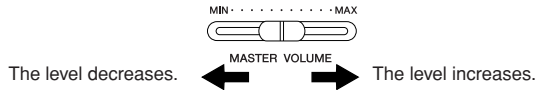

CAUTION

Do not use the instrument at a high volume level for a long period of time; doing so may damage your hearing.

TERMINOLOGY MASTER VOLUME:

The volume level of the entire keyboard sound.

Using Headphones

Connect a pair of headphones to one of the [PHONES] jacks.

Two [PHONES] jacks are provided.

You can connect two sets of standard stereo headphones. (If you are using only one pair of headphones, you can plug them into either jack.)

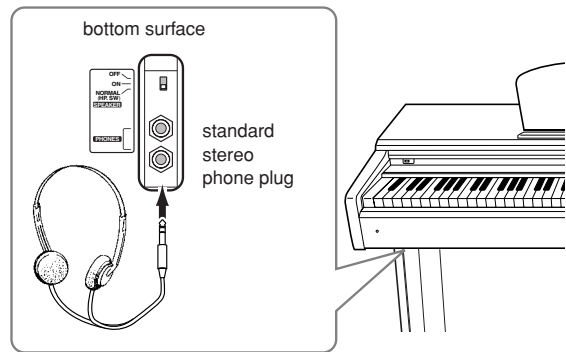

Using the Headphone Hanger

A headphone hanger is included in the instrument package so that you can conveniently hang the headphones on the instrument. Install the headphone hanger using included two screws (4 x 10mm) as shown in the figure.

Notice

Do not hang anything other than the headphones on the hanger. Doing so may damage the instrument or the hanger.

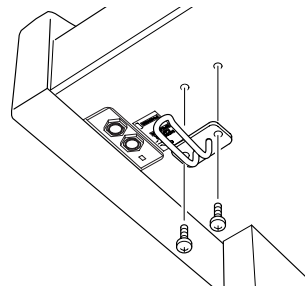

Using the Speaker Switch

This switch turns the internal speakers on or off.

NORMAL (HP. SW) The speakers produce sound as long as a pair of headphones is not connected.

ON The speakers always produce sound.

OFF The speakers produce no sound.

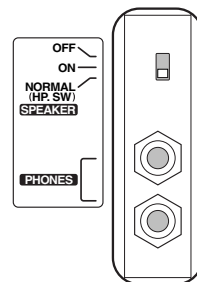

Listening to the Demonstration Tunes

Demonstration tunes are provided that effectively demonstrate each of the instrument's voices.

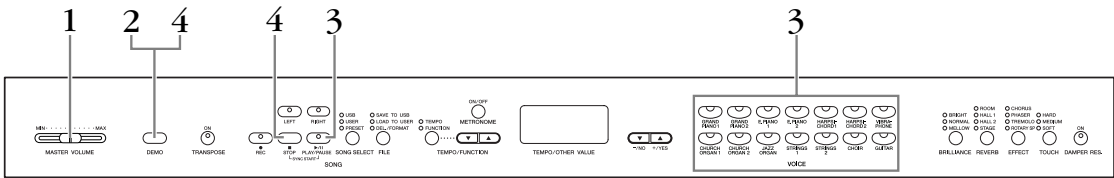

Procedure

1. Turn the power on.

(In case the power is not turned ON) Press the **[POWER]** switch.

When the power is turned ON, one of the voice button LEDs will light.

Initially set the **[MASTER VOLUME]** slider about half way between the “MIN” and “MAX” settings. Then, when you start playing, re-adjust the **[MASTER VOLUME]** slider to the most comfortable listening level.

2. Engage Demo mode.

Press the **[DEMO]** button to engage Demo mode. The voice button indicators will flash in sequence.

3. Play a Voice demo.

Press one of the voice buttons to start playback of all songs starting from the corresponding voice demo tune — featuring the voice normally selected by that voice button. (If you press the **SONG [PLAY/PAUSE]** button instead of a voice button or only waiting (not press any keys) a short while, the GRAND PIANO 1 demo tune will begin playback.)

4. Stop the Voice demo and exit from Demo mode.

Press the **[DEMO]** or **SONG [STOP]** button.

NOTE

For a list of the demo songs, see page 57.

NOTE

MIDI reception is not possible in Demo Song mode.
Demo song data is not transmitted via the MIDI terminals.

NOTE

Demo mode cannot be engaged during User song recording (page 27) or file operations (page 33).

TERMINOLOGY

Mode:

A mode is a status under which you can execute a certain function. In Demo mode, you can play back demonstration tunes.

NOTE

You cannot adjust the tempo of demo songs.

You cannot use the part cancel function (page 17) or the song A-B repeat function (page 18) in Demo mode.

Listening to 50 Piano Preset Songs

The instrument provides performance data of 50 piano songs. You can simply listen to these songs or use them for practice (page 17). You can also refer to the included “50 greats for the Piano” that contains scores for the 50 piano preset songs.

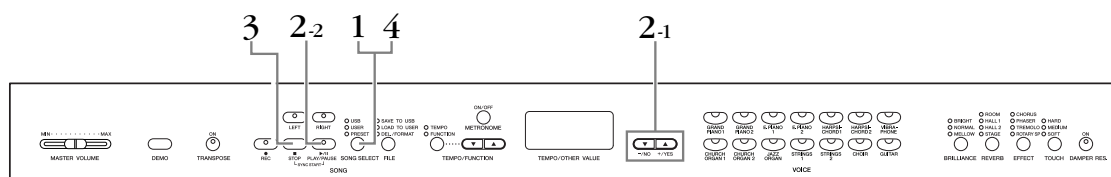

Procedure

1. Engage Preset Song mode.

Press the [SONG SELECT] button a few times until the “PRESET” indicator lights.

2. Play any of the 50 preset songs.

2-1 Press the [-/NO], [+ /YES] buttons to select a number of the tune you want to play (the number will appear on the LED display) or select a playing method.

1 – 50: Select a preset song number and play only the song.

r n d: Play all preset songs continuously in random order.

ALL: Play all preset songs in sequence.

2-2 Press the SONG [PLAY/PAUSE] button to start playback.

Adjust the Volume

Use the [MASTER VOLUME] control to adjust the volume.

Adjust the Tempo

You can use the [TEMPO/FUNCTION ▼, ▲] buttons to adjust the playback tempo as required. The default tempo can be recalled by simultaneously pressing the [▼] and [▲] buttons.

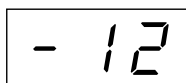

This produces a relative tempo variation, with a range from “-50” through “0” to “50” at maximum; the range will differ depending on the selected song.

3. Stop playback.

Playback will stop automatically when the selected preset song has finished. To stop the song during playback (or continuous playback), press the SONG [STOP] button. You can also pause playback by pressing the SONG [PLAY/PAUSE] button.

- To play back another song continuously, see procedure 2 above.

4. Exit from Preset Song mode.

Press the [SONG SELECT] button to exit Preset Song mode. The indicator turns off, and the unit returns to normal play mode.

How to use the practice functions

You can turn the left- and right-hand parts on or off as required so you can practice the corresponding part (part cancel function) and continuously repeat a specified phrase within a song (song A-B repeat function). For more information, see pages 17–18.

NOTE

Preset Song mode cannot be engaged while the unit is in Demo Song mode (page 15) or during song playback (page 41), User song recording (page 27), or file operations (page 33).

TERMINOLOGY

Song:

Performance data is called a “Song.” This includes demonstration tunes and piano preset tunes.

NOTE

You can play the keyboard along with the preset song. You can change the voice playing on the keyboard.

NOTE

You can adjust the Brilliance control (page 21) and Reverb type (page 21) that is applied to preset song playback.

You can change the Effect settings (page 22) and Touch sensitivity (page 23) for the keyboard voice you play.

NOTE

The default tempo “0” is automatically selected whenever a new preset song is selected, or when playback of a new preset song begins during “ALL” or “r n d” playback.

NOTE

When you select a different song (or a different song is selected during chained playback), appropriate reverb and effect types will be selected accordingly.

Practicing a One-Hand Part Using the 50 Preset Songs (Part Cancel Function)

The 50 preset songs have separate left- and right-hand parts on individual parts. You can turn the left- and right-hand parts on or off as desired, in order to practice the corresponding part (the part that is turned off) on the keyboard. The right-hand part is played by **[RIGHT]** and the left-hand part is played by **[LEFT]**.

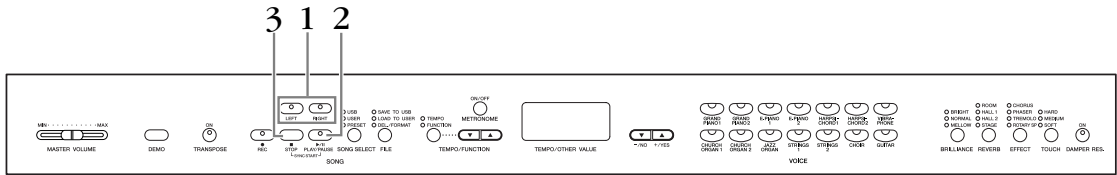

Procedure

1. Turn off the playback part you wish to practice.

After you select a song to practice, press the **[RIGHT]** or **[LEFT]** button to turn off the corresponding part.

When you first select a song, both **[RIGHT]** and **[LEFT]** indicators light up, indicating that you can play back both parts. When you press one of the buttons to turn off playback, the corresponding button indicator turns off and the corresponding part playback is muted.

- Pressing the buttons repeatedly toggles playback between on and off.

2. Start playback and playing.

Press the **SONG [PLAY/PAUSE]** button to start playback. Play the part you just turned off.

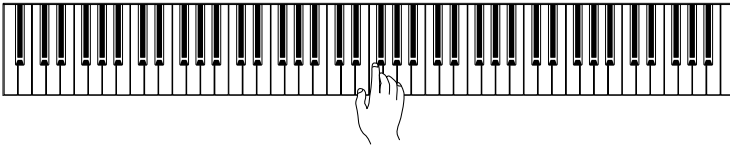

Starting playback automatically as you start playing the keyboard (Sync Start)

When the Sync Start function is engaged, playback of the selected preset song will begin automatically as soon as you start playing on the keyboard.

To engage the Sync Start function, simultaneously hold down the **SONG [STOP]** and press the **[PLAY/PAUSE]** button.

(Repeat the previous operation to disengage the Sync Start function.)

Playback will then start as soon as you begin playing on the keyboard.

Left Pedal Play/Pause

The left pedal can be assigned to play and pause preset song playback via the "Left Pedal Mode" function described on page 47.

3. Stop playback.

When playback is complete, it automatically stops and the instrument locates the top of the song. If you wish to stop playback in the middle of a song, press the **SONG [STOP]** button. You can also pause playback by pressing the **SONG [PLAY/PAUSE]** button.

NOTE

The Preset Song Part Cancel function cannot be used during "ALL" or "r n d" (page 16) playback.

NOTE

The parts can be turned on or off even during playback.

NOTE

Both parts are automatically turned ON whenever a new song is selected.

A-B Repeat for 50 Preset Songs

The A-B Repeat function can be used to continuously repeat a specified phrase within a preset song. Combined with the Part Cancel function described on page 17, this provides an excellent way to practice difficult phrases.

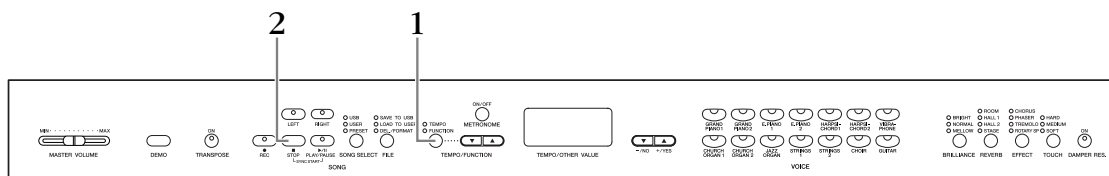

Procedure

1. Specify the beginning (A) and the end (B) of the phrase, and start practicing.

Select and play a preset song, then press the [TEMPO/FUNCTION] button at the beginning of the phrase you want to repeat.

This sets the "A" point (A -) will appear on the display).

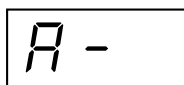

To specify the end (B) of the phrase, press the [TEMPO/FUNCTION] button a second time at the end of the phrase.

This sets the "B" point (A - b) will appear on the display).

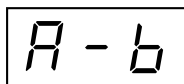

At this point, repeat playback will begin between the specified A and B points.

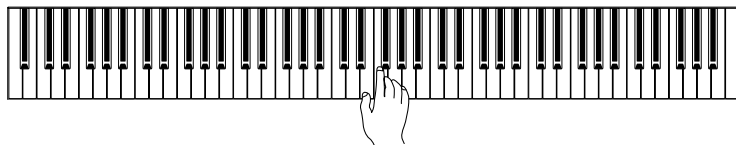

2. Stop playback.

Press the SONG [STOP] button to stop playback while retaining the specified A and B points. A-B repeat playback will resume if you press the SONG [PLAY/PAUSE] button.

To cancel the A and B points, press the [TEMPO/FUNCTION] button once.

NOTE

The A-B Repeat function cannot be used during "ALL" or "r n d" (page 16) playback.

NOTE

- To set the "A" point at the very beginning of the song, press the [TEMPO/FUNCTION] button before starting playback.
- You can have the B point automatically be set to the song's end, by setting the A point and letting the song play to the end.

NOTE

An automatic lead-in (to help guide you into the phrase) starts at the A point of the song.

NOTE

The A and B points are automatically canceled when a new song is selected.

Selecting & Playing Voices

Selecting Voices

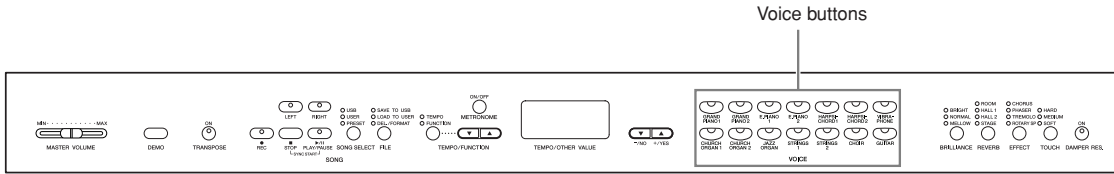

Procedure

Select the desired voice by pressing one of the Voice buttons.

Then, when you start playing, re-adjust the [MASTER VOLUME] slider for the most comfortable listening level.

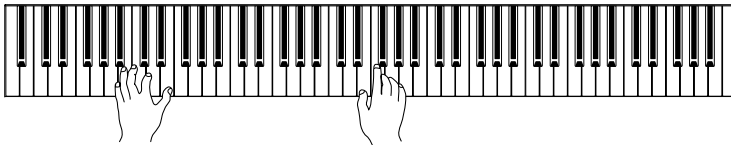

NOTE

To learn characteristics of the voices, listen to demo songs for each voice (page 15). Refer to "Preset Voice List" on page 57 for more information on the characteristics of each preset voice.

TERMINOLOGY

Voice:
On the instrument, a voice means a "tone" or "tonal color."

NOTE

You can control the loudness of a voice by adjusting the force with which you strike the keys, although different playing styles (touch sensitivities) have little or no effect with certain musical instruments. Refer to "Preset Voice List" on page 57.

Using the Pedals

The instrument has three foot pedals that produce a range of expressive effects similar to those produced by the pedals on an acoustic piano.

Damper (Right) Pedal

The damper pedal functions in the same way as a damper pedal on an acoustic piano. When the damper pedal is pressed, notes sustain longer. Releasing the pedal immediately stops (damps) any sustained notes.

The damper pedal also features a naturally expressive half-pedal function.

When DAMPER RES. is on, the instrument simulates the sustain sound that occurs when you press the damper pedal of a grand piano, as you press the damper pedal and play the keyboard.

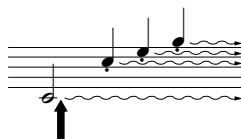
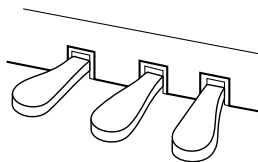

When you press the damper pedal here, the notes you play before you release the pedal have a longer sustain.

Sostenuto (Center) Pedal

If you play a note or chord on the keyboard and press the sostenuto pedal while the note(s) are held, those notes will sustain as long as you hold the pedal (as if the damper pedal had been pressed) but all subsequently played notes will not be sustained. This makes it possible to sustain a chord, for example, while other notes are played “staccato.”

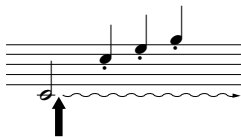

When you press the sostenuto pedal here while holding the note, the note will sustain as long as you hold the pedal.

Soft (Left) Pedal

The soft pedal reduces the volume and slightly changes the timbre of notes played while the pedal is pressed. The soft pedal will not affect notes that are already playing when it is pressed.

NOTE

If the damper pedal doesn't work, make sure that the pedal cord is properly plugged into the jack (page 60).

TERMINOLOGY:

Half-pedal:

While playing the piano with Sustain and you want to slightly mute the sustained sound, release the damper pedal from maximum position to half position.

NOTE

Organ, string and choir voices will continue to sound for as long as the sostenuto pedal is depressed.

NOTE

The left pedal can be assigned to song play/pause operation via the “Left Pedal Mode” described on page 47.

NOTE

The depth of the effect produced by the Soft Pedal can be adjusted via the “Soft Pedal Effect Depth” (page 47) in the Function mode.

Adding Variations to the Sound — [BRILLIANCE]/[REVERB]/[EFFECT]/[DAMPER RES.]

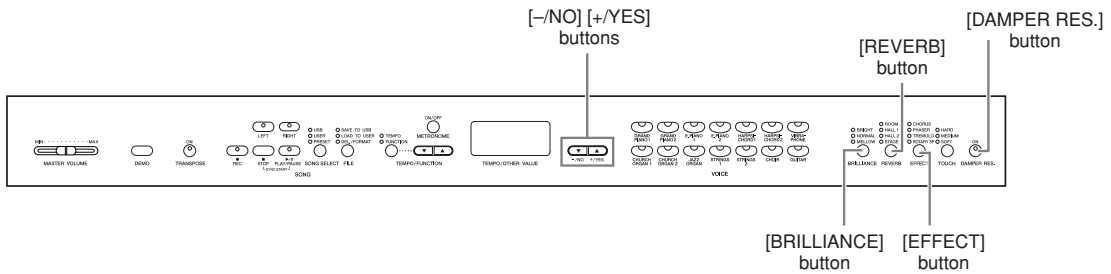

[BRILLIANCE]

This control can be used to change the tonality or “timbre” of the sound output.

- BRIGHT:** Bright tone
NORMAL: Standard tone
MELLOW: Soft and mellow tone

Procedure

To select a brilliance type, press the [BRILLIANCE] button a few times until the indicator corresponding to the desired type lights (the indicator lights in sequence each time you press the [BRILLIANCE] button). Brilliance can be selected among five types. When two adjacent indicators are lit, the type that is between the two indicated types is selected. For example, when both NORMAL and MELLOW are lit, the brilliance setting between NORMAL and MELLOW is selected. This parameter affects the entire sound of the instrument.

[REVERB]

This control enables you to select various digital reverb effects that would add extra depth and expression to the sound to create a realistic acoustic ambience.

- OFF:** When no reverb effect is selected, no REVERB indicator is lit.
ROOM: This setting adds a continuous reverb effect to the sound, similar to the acoustic reverberation you would hear in a room.
HALL 1: For a “bigger” reverb sound, use the HALL 1 setting. This effect simulates the natural reverberation of a small-size concert hall.
HALL 2: For a truly spacious reverb sound, use the HALL 2 setting. This effect simulates the natural reverberation of a large concert hall.
STAGE: Simulates the reverb of a stage environment.

Procedure

To select an reverb type, press the [REVERB] button a few times until the indicator corresponding to the desired type lights (the indicators light in sequence each time you press the [REVERB] button). No effect is produced when all indicators are off.

Adjusting Reverb Depth

Adjust the reverb depth for the selected voice by using the [-/NO] [+ /YES] buttons while holding the [REVERB] button. The depth range is from 0 through 20. The current depth setting appears on the LED display while the [REVERB] button is held.

TERMINOLOGY

Normal setting:

The “Normal setting” refers to the default setting (factory setting) obtained when you first turn on the power to the instrument.

NOTE

Normal setting = NORMAL

NOTE

When the BRILLIANCE is set to BRIGHT, the overall sound will be slightly louder. If the MASTER VOLUME is set at a high level the sound may become distorted. If so, lower the MASTER VOLUME level.

NOTE

The default reverb type (including OFF) and depth settings are different for each voice.

NOTE

Releasing the [REVERB] button changes the reverb type. If you have changed the reverb depth, releasing the [REVERB] button will not change the reverb type.

NOTE

Depth 0: no effect
Depth 20: maximum reverb depth

[EFFECT]

The [EFFECT] button allows you to select an effect to give your sound greater depth and animation.

- OFF:** When no effect is selected, no EFFECT indicator is lit.
CHORUS: A shimmering, broadening effect
PHASER: Adds a sweeping effect to the sound.
TREMOLO: Tremolo effect
ROTARY SP: Adds the vibrato effect of a rotary speaker.

Procedure

To select an effect type, press the [EFFECT] button a few times until the indicator corresponding to the desired type lights (the indicators light in sequence each time you press the [EFFECT] button). No effect is produced when all indicators are off.

Adjusting Effect Depth

You can adjust the effect depth for the selected voice by using the [-/NO] and [+ /YES] buttons while holding the [EFFECT] button.

The depth range is from 0 through 20. The current depth setting appears on the LED display while the [EFFECT] button is held.

[DAMPER RES.]

The Damper Resonance lets you hear a simulation of the sustain sound of the damper pedal on a grand piano, as you press the damper pedal and play the keyboard. This effect is applied to the entire sound of the instrument.

Procedure

Pressing the [DAMPER RES.] button repeatedly toggles the Damper Resonance on and off.

Adjusting DAMPER RES. Depth

You can adjust the Damper Resonance depth by using the [-/NO] and [+ /YES] buttons while holding the [DAMPER RES.] button.

The depth range is from 0 through 20. The current depth setting appears on the LED display while the [DAMPER RES.] button is held.

NOTE

The default effect type (including OFF) and depth settings are different for each voice.

NOTE

Releasing the [EFFECT] button changes the effect type. If you have changed the depth settings, releasing the [EFFECT] button will not change the effect type.

NOTE

Depth 0: no effect
Depth 20: maximum effect depth

NOTE

Default depth settings are different for each voice.

NOTE

Normal setting = ON

NOTE

Depth 0: no effect
Depth 20: maximum depth

Touch Sensitivity — [TOUCH]

You can select four different types of keyboard touch sensitivity — HARD, MEDIUM, SOFT or FIXED — to match different playing styles and preferences.

- HARD:** Requires that the keys be played quite hard to produce maximum loudness.
- MEDIUM:** Produces a fairly “standard” keyboard response.
- SOFT:** Allows maximum loudness to be produced with relatively light key pressure.
- FIXED:** All notes are produced at the same volume no matter how hard the keyboard is played. (No indicators are lit.) The fixed volume can be changed.

NOTE

This setting does not change the weight of the keyboard.

NOTE

Normal setting = MEDIUM

NOTE

The touch sensitivity type will become the common setting for all voices. However, the touch sensitivity settings may have little or no effect with certain voices that are not normally responsive to keyboard dynamics. (Refer to the “Preset Voice List” on page 57.)

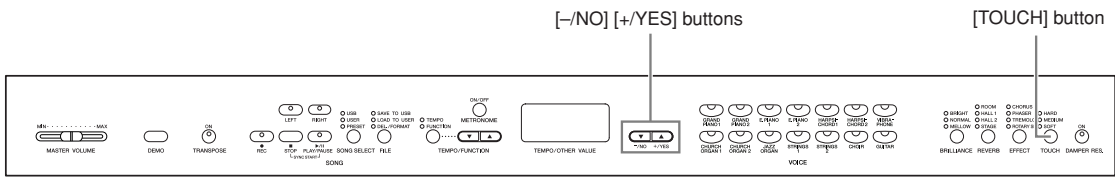

Procedure

To select a touch sensitivity type press the [TOUCH] button a few times until the indicator corresponding to the desired type lights (the indicators light in sequence each time the [TOUCH] button is pressed). No indicator is lit when “FIXED” is selected.

Changing the volume when FIXED is selected

When you select FIXED, you can set the volume for notes played in FIXED mode by using the [-/NO] and [+ /YES] buttons while you hold the [TOUCH] button. The current volume level appears on the display. The volume range is from 1 through 127. The default setting is 64.

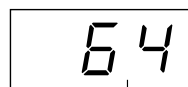

Volume range

NOTE

1: minimum volume
127: maximum volume

NOTE

The touch volume set in FIXED mode will become the common setting for all voices.

NOTE

Releasing the [TOUCH] button changes the touch type. If you have changed the volume, releasing the [TOUCH] button will not change the touch type. (FIXED mode will remain selected.)

Transposition — [TRANPOSE]

The instrument's Transpose function makes it possible to shift the pitch of the entire keyboard up or down in semitone intervals to facilitate playing in difficult key signatures, and to let you easily match the pitch of the keyboard to the range of a singer or other instruments. For example, if you set the transposition amount to “5,” playing a C key produces a pitch of F. In this way, you can play a song as though it were in C major, and the instrument will transpose it to F major.

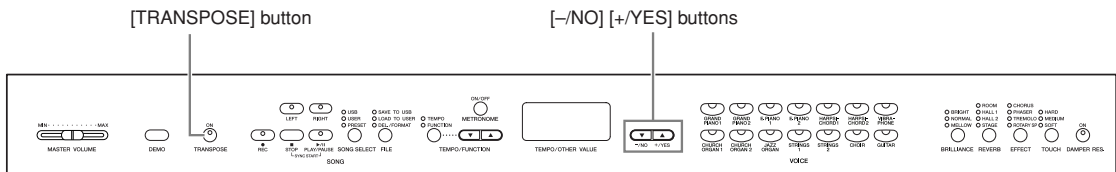

Procedure

Use the [-/NO] and [+ /YES] button while holding the [TRANPOSE] button to transpose down or up as required. The amount of transposition appears on the LED display while the [TRANPOSE] button is held. The default transpose setting is “0.”

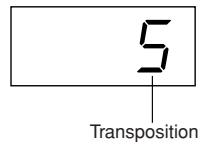

The [TRANPOSE] button indicator remains lit when a transpose setting other than “0” is selected. If a value other than “0” is selected, the [TRANPOSE] button can be switched the transpose function ON or OFF at any time.

TERMINOLOGY

Transpose:

Change the key signature of a song. On the instrument, transposing shifts the pitch of the entire keyboard.

NOTE

The transposition range:

-12: -12 semitones (down one octave)

0: normal pitch

12: 12 semitones (up one octave)

Combining Two Voices (Dual mode)

You can play two voices simultaneously across the entire range of the keyboard. In this way, you can simulate a melody duet or combine two similar voices to create a thicker sound.

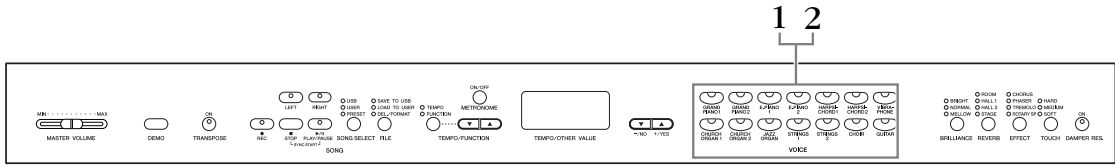

Procedure

1. Engage Dual mode.

Press two voice buttons at the same time (or press one voice button while holding another). The voice indicators of both selected voices will light when Dual mode is active.

- According to the voice numbering priority shown in the diagram on the right, the lower value voice number will be designated as Voice 1 (the other voice will be designated as Voice 2).

Voice numbering priority

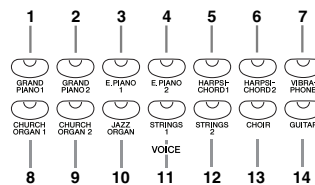

The Function mode provides access to a number of other Dual mode functions, such as volume balance setting or octave setting (page 46). (If you do not set Dual mode functions, the appropriate setting will be set in each voice by default.)

2. Exit Dual mode and return to normal play mode.

To return to the normal single-voice play mode, press any single voice button.

NOTE

[REVERB] in Dual Mode

The reverb type assigned to Voice 1 will take priority over the other. (If the reverb is set to OFF, Voice 2 reverb type will be in effect.)

NOTE

[EFFECT] in Dual Mode

Depending on the conditions, one effect type may take priority over the other. Depth will be decided according to the depth default value of the voice combination. However, using function F3 (page 46) you can adjust the depth value for each voice to your liking.

Using the Metronome

The instrument features a built-in metronome (a device that keeps an accurate tempo) that is convenient for practicing.

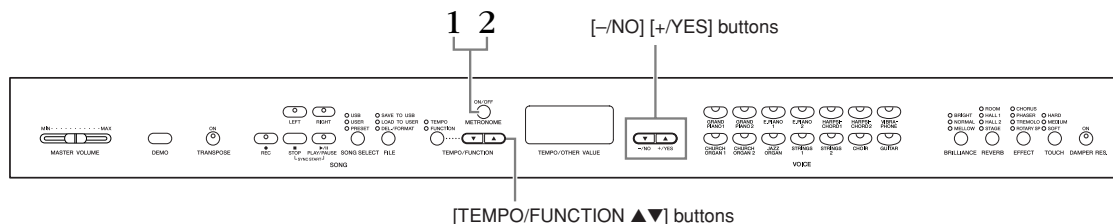

Procedure

1. Start the metronome.

The metronome sound is turned on by pressing the **METRONOME [ON/OFF]** button.

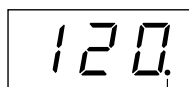

The beat indicator flashes at the current tempo.

Adjusting the tempo

The tempo of the metronome and user song recorder playback (the recorder is described in the next section) can be set from 32 to 280 beats per minute by using the **[TEMPO/FUNCTION ▼, ▲]** buttons (when the **[TEMPO/FUNCTION ▼, ▲]** button's **[TEMPO]** indicator is lit).

Adjusting the time signature

The time signature (beat) of the metronome can be set by using the **[-/NO]** and **[+ /YES]** buttons while holding the **METRONOME [ON/OFF]** button. You can set the beat from 0 to 15. The current setting appears on the LED display while you are holding the **METRONOME [ON/OFF]** button.

A beat setting of “0” plays a low click sound for all beats, while a setting of “1” plays a high click sound for all beats; other beat settings play a high click for the first beat in a measure and a low click for all following beats.



Beat

NOTE

If the **[TEMPO/FUNCTION]** button's **[TEMPO]** indicator is not lit, press the **[TEMPO/FUNCTION]** button to light the **[TEMPO]** indicator.

NOTE

The volume of the metronome can be adjusted via the Metronome Volume function in Function mode (page 47).

2. Stop the metronome.

Turn off the metronome by pressing the **METRONOME [ON/OFF]** button.

Recording Your Performance

The ability to record and play back what you've played on the instrument can be an effective practice aid. You can, for example, record just the left-hand part, and then practice the right-hand part while playing back the recorded left-hand part. Or, since you can record up to two parts separately, you could record the left-and right-hand parts separately, or record both parts of a duet and hear how they sound when played back. The two-part Song Recorder on the instrument allows the recording of up to three User songs (U01 – U03) to the instrument. User songs can be saved to an optional USB storage device.

Recording a performance quickly

This convenient and simple recording method lets you quickly record your performance without specifying the recording parts — useful, for example, in recording solo piano pieces. In this way, the performance is automatically recorded to right part.

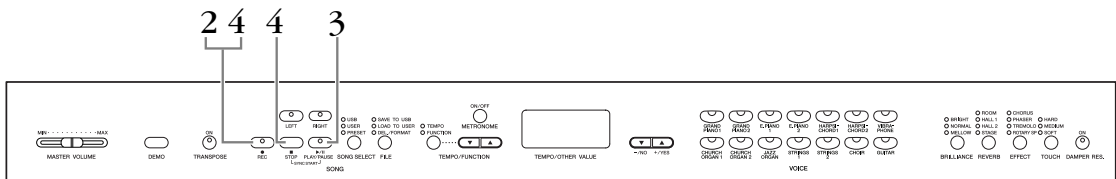

Notice

To avoid erasing previously recorded song(s):

If the song contains data, the part indicator lights up green when you select a song. Note that recording new data on this part will erase the existing data.

You cannot record the performance to the connected USB storage device directly. The recorded songs are saved to the instrument automatically. If you want to save data to the device, perform the Save operation (page 34) after stopping recording.

TERMINOLOGY

Recording vs. Saving:

The format of performance data recorded on a cassette tape differs from that of data recorded on the instrument. A cassette tape records audio signals. The instrument "saves" information regarding note timing, voices, and a tempo value, but not audio signals. When you play back recorded songs, the instrument produces sound based on the saved information. Therefore, recording on the instrument may be more accurately called "saving information." However, this book often uses the word "recording" because it seems to make more sense.

Procedure

1. Make all the initial settings.

Before you begin to record, select the voice you want to record (or voices if you will be using Dual). Make any other desired settings (reverb, effect, etc.) as well. You might also want to set the volume.

You can also adjust the playback volume using the [MASTER VOLUME] slider.

2. Engage Record Ready mode.

Press the [REC] button to engage Record Ready mode. This automatically selects an empty song for recording and makes the RIGHT part active. If an empty song does not exist, Song U01 will be selected. Recording does not actually start yet.

The SONG [PLAY/PAUSE] indicator will flash at the current METRONOME tempo setting.

You can turn on the metronome in this step, and adjust the tempo by using the [TEMPO/FUNCTION ▼, ▲] buttons. (Range: 32 – 280)

Record Ready mode can be disengaged before recording by pressing the [REC] button again.

3. Start recording.

Recording will begin automatically as soon as you play a note on the keyboard or press the SONG [PLAY/PAUSE] button. The current measure's number will appear on the display while recording.

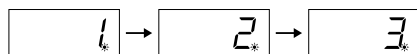

4. Stop recording.

Press either [REC] or SONG [STOP] button to stop recording. When recording is stopped, dashes appear in the display in succession to indicate that the recorded data is being saved to the instrument automatically. After the data is saved, the song name (U01 – U03) appears in the display. The recorded part's indicator will glow green to indicate that it now contains data. (Record mode is disengaged automatically.)

Notice

Do not turn off the power of the instrument when dashes appear in the display in succession. Doing so may delete all song data in the instrument, including external songs (page 40).

NOTE

When the instrument is in Demo Song mode or during a file operation, Record mode cannot be engaged.

NOTE

Recording capacity

You can record up to a maximum three songs, or up to a maximum of about 100KB (11,000 Notes) in each song on the instrument depending on pedal usage and other factors.

NOTE

If you have selected the LEFT part previously in the same song, the LEFT part will automatically be made active when pressing the [REC] button in step 2.

NOTE

If the metronome was on when you started recording, you'll be able to keep time with the metronome while recording, but the metronome sound will not be recorded.

NOTE

For more recording information, see page 31.

NOTE

The left pedal can be assigned to start recording via the "Left Pedal Mode" function described on page 47.

NOTE

If the memory becomes full during recording, "FUL" will appear on the display and recording will stop automatically. (All recorded data up to that point will be retained.)

Playing back a recorded song

Procedure

1. Play back the recorded performance.

Press the **SONG [PLAY/PAUSE]** button to play back the recorded performance.

2. Stop the performance.

To stop playback in the middle of a song, press the **SONG [STOP]** button.

Re-recording a previously recorded song

This section explains how to record again in case your performance was not satisfactory.

Procedure

1. Select a voice or voices (and other settings) for recording, if necessary.

Repeat Step 1 on page 28 if you wish to change the previous settings.

For more information of the recorded data see page 31.

2. Re-engage Record Ready mode.

Press the **[REC]** button, again.

The selected part's indicator lights in red.

Follow the procedure from Step 3 in “Recording a performance quickly” on page 28 to re-record.

NOTE

If you want to change the tempo, reverb type, or effect type when re-recording a part or when recording to another part, do so after you engage Record Ready mode.

You cannot re-record in the middle of a song.

Recording to RIGHT/LEFT parts

This lets you record the right and left parts separately. Since you can record the left part while playing back the right, this is useful for recording both parts of a duet.

Procedure

1. Make all the initial settings.

Same as step 1 in “Recording a performance quickly” on page 28.

2. Select a song to record.

Press the [SONG SELECT] button to light “USER” indicator on, then press the [-/NO][+/YES] buttons to select a song for recording.

Notice

To avoid erasing previously recorded song(s):

If the song contains data, the part indicator lights up green when you select a song. Note that recording new data on this part will erase the existing data.

3. Engage Record Ready mode.

Press the [REC] button and press the [RIGHT]/[LEFT] button to engage Record Ready mode. Recording does not actually start yet.

The SONG [PLAY/PAUSE] indicator will flash at the current METRONOME tempo setting.

Record Ready mode can be disengaged before recording by pressing the [REC] button again.

4. Start and stop recording.

Same as step 3 – 4 in “Recording a performance quickly” on page 28.

NOTE

Part button indications

Off: Contains no data

On (green): Contains data

On (red): Part is enabled for recording

NOTE

Recording capacity

You can record up to a maximum three songs, or up to a maximum of about 100KB (11,000 Notes) in each song on the instrument depending on pedal usage and other factors.

NOTE

If the metronome was on when you started recording, you'll be able to keep time with the metronome while recording, but the metronome sound will not be recorded.

NOTE

If you want to change the time signature, make sure to change it before entering Record Ready mode.

If you want to change the tempo, reverb type, or effect type when rerecording a part or when recording to another part, do so after entering Record Ready mode.

The Time Signature of a recorded song cannot be changed. If you want to record a song with another Time Signature, first save a song to USB storage (see page 34), and delete the recorded both parts of the song (see page 31, Deleting a selected part), then set the desired time signature, and begin a new recording.

NOTE

If you don't want to hear the previously recorded part while you record (for example, when you want to record a song different from what you recorded on the previous part), press the play-back part button before pressing the [REC] button so that its indicator is turned off.

For more information on recording, see page 31.

The user song recorder records the following data:

Data in addition to the notes and voices you play is recorded.

This data includes “Individual Parts” and “Entire Song.” See below.

Individual Parts

- Notes played
- Voice selection
- Pedal (Damper/Soft/Sostenuto)
- [REVERB] depth
- [EFFECT] depth
- Dual mode voices
- Dual balance (F3)
- Dual detune (F3)
- Dual octave shift (F3)

Entire Song

- Tempo
- Time signature (beat)
- [REVERB] type (including OFF)
- [EFFECT] type (including OFF)

Deleting Recorded Performance Data

This section explains how to delete the right and left parts separately.

1. Select a song to delete.

Press the [SONG SELECT] button so that the USER indicator lights, then use the [-/NO][+/YES] buttons to select a song for deleting.

2. Engage Record Ready mode and select a part to be deleted.

Press the [REC] button and press the [RIGHT]/[LEFT] button to engage Record Ready mode. Recording does not actually start yet.

The SONG [PLAY/PAUSE] indicator will flash at the current METRONOME tempo setting.

To cancel the delete operation, press the [REC] button again.

3. Delete the selected part

Press the SONG [PLAY/PAUSE] button to start recording. Then, without playing the keyboard, press the SONG [STOP] button to stop recording. All data previously recorded for the selected part will be deleted.

NOTE

The entire recorded user song cannot be deleted, but only selected parts.

Changing the Initial Settings (Data recorded at the beginning of a song)

The initial settings (data recorded at the beginning of a song) can be changed after the recording. For example, after recording, you can change the voice to create a different ambience or adjust the song tempo to your taste.

You can change the following initial settings.

Individual Parts

- Voice selection
- [REVERB] depth
- [EFFECT] depth
- Dual mode voices
- Damper/soft pedal depth

Entire Song

- Tempo
- [REVERB] type (including OFF)
- [EFFECT] type (including OFF)

1. Change the settings via the panel controls.

For example, if you wish to change the recorded voice from [E. PIANO 1] to [E. PIANO 2], press the [E. PIANO 2] button.

2. Engage Record mode and select a part to change the initial settings.

The indicator glows red. (Data shared by two parts can be changed via either part.)

Notice

Be careful not to press the SONG [PLAY/PAUSE] button or a key on the keyboard, either of which will start recording and erase all previously-recorded data on the selected part.

3. Press the [REC] button to exit Record mode.

Handling Songs with a USB Storage Device

You can handle User songs (save, load, and delete) with a USB storage device. You can also format the device or media.

Before using a USB device, read the “Precautions when using the USB TO DEVICE terminal” section on page 38.

About Save and Load

Save

You can save three User songs in the instrument to the USB storage device as SMF song files. These songs can be saved to a “container” (or memory location) in the USB storage device. 100 containers are available — S00 – S99.

Since the User songs are saved in SMF format, they can be played back on other instruments, including other instruments.

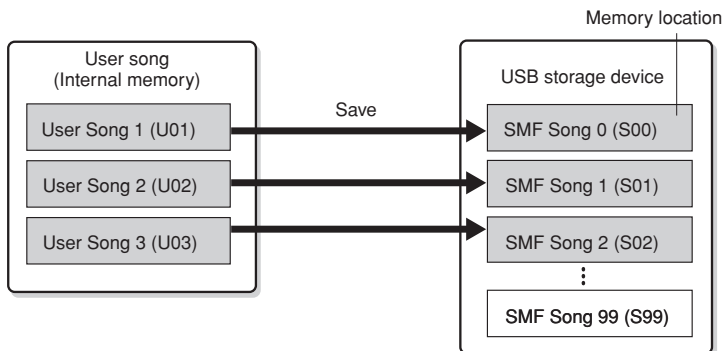

Load

If you want to only play the song in the USB storage device, the following operation is not necessary. For instructions on playing the song, see “Playing Back User Songs from a USB Storage Device” on page 42. The Load operation can be used if you want to edit the recorded song on the instrument. Data can be loaded to User Song 3 (U03).

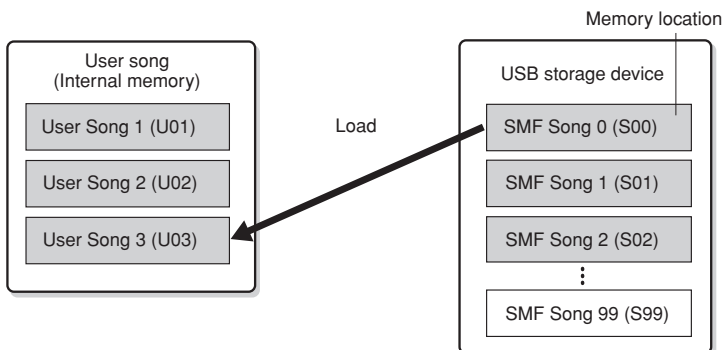

NOTE

For details on connecting a USB storage device, see page 38.

NOTE

Before handling songs with a USB storage device, make sure that the device is not protected. If the device is protected, you cannot access it.

NOTE

The file numbers which can be handled in this instrument are 100 files.

- SMF song numbers: S00 – S99

NOTE

The “S” indication at the top of the User file name represents “SMF.”

TERMINOLOGY

SMF (Standard MIDI File):

The SMF (Standard MIDI File) format is one of the most common and widely compatible sequence formats used for storing sequence data. There are two variations: Format 0 and Format 1.

A large number of MIDI devices are compatible with SMF Format 0, and most commercially available MIDI sequence data is provided in SMF Format 0. The SMF format for sequence files allows you to exchange song data between different sequencers. User songs recorded on the instrument are SMF Format 0.

Saving a Song

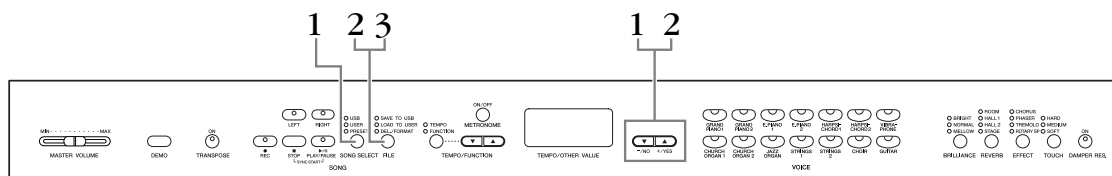

Procedure

1. Select a User song to save.

Select a User song to save by using the [SONG SELECT] and [-/NO][+/YES] buttons.

2. Select a song container in the device and save the User song.

After making sure that the USB storage device is connected to the instrument, press the [FILE] button (the “SAVE TO USB” indicator lights). Then, while holding the [FILE] button, simultaneously press the [-/NO][+/YES] buttons to select a container (S00 – S99). After releasing the [FILE] button, “n y” (no/yes) appears in the display. Press the [+ /YES] button to save the songs. The song is saved into the “USER FILES” folder and named as “USERSONGxx.MID.”

Overwriting the song

If you select a container which contains an SMF song, three dots appear in the display (ex., “S.0.0.”). If you do not want to overwrite the file, press the [-/NO] button when “n y (no or yes)” appears in the display and select another container. If you want to overwrite the song, press the [+ /YES] button. After “n-y” appears in the display again to confirm whether you wish to overwrite the file or not, press the [+ /YES] button once more.

Notice

While the instrument is accessing data (such as during Save, Load, Delete and Format operations) or is mounting the USB storage device (shortly after the connection: until the FILE LOAD LED flash stops), do NOT unplug the USB cable, do NOT remove the media from the device, and do NOT turn the power off to either devices. Doing so may corrupt the data on either or both devices.

3. Exit from the file operation mode.

Press the [FILE] button several times to exit the file operation mode. (The FILE indicators turn off.)
Play the recorded song (see page 40).

Notice

Do not rename User files on a computer. If the file name is changed in this way, the file cannot be loaded to the instrument.

NOTE

If the selected song has no data, the song will not be saved (you cannot select a container for SMF songs — S00 – S99). Confirm that the selected song has data by making sure that the indicator of [RIGHT] or [LEFT] is turned on.

NOTE

If there is not enough capacity left on the USB storage device to save or export the data, an appropriate message will appear on the display and you will not be able to save or export the data. Delete unwanted files from the device to make more memory available (page 36), or use another device.

NOTE

If you move an SMF song from the “USER FILES” folder to the top folder using a computer, the file type will be changed — from a SMF song (S00 – S99) to an External song.

Loading a Song

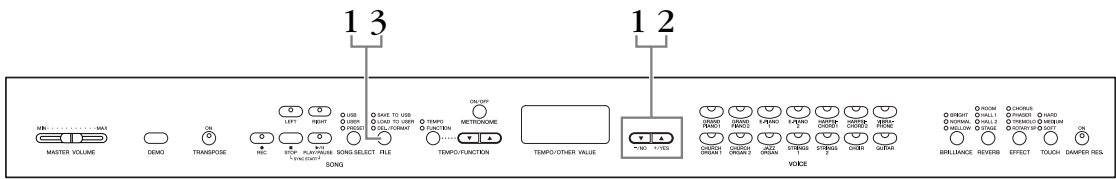

Procedure

Notice

If the User file (U03) on the instrument already contains data, this operation can result in overwriting of the data. Make sure to save important data to your computer beforehand.

1. Select a song container in the device.

After making sure that the USB storage device is connected to the instrument, press the **[FILE]** button (the “LOAD TO USER.” indicator lights). Then, while holding the **[FILE]** button, press the **[-/NO][+/YES]** buttons to select a song (S00 – S99). Data saved on the instrument can only be loaded back to the instrument.

2. Load a song to User Song (U03).

“n y” (no/yes) appears in the display. Press the **[+/YES]** button to load a song. The file will automatically be loaded into the User Song (U03).

The indication “-” moves from left to right in display, indicating that save operation is in process.

Notice

While the instrument is accessing data (such as during Save, Load, Delete and Format operations) or is mounting the USB storage device (shortly after the connection: until the LOAD TO USER LED flash stops), do NOT unplug the USB cable, do NOT remove the media from the device, and do NOT turn the power off to either devices. Doing so may corrupt the data on either or both devices.

Notice

Do not manually change the file name on the USB storage device by using a computer; doing so will render the file unplayable or unable for loading on the instrument.

Notice

Do not turn off the power to the instrument while flashing dashes appear in the display (indicating the operation is in process). Doing so may damage the data.

When loading is completed, the “End” indication appears in the display, and the song is loaded into the User Song (U03).

3. Exit from the load operation mode.

Press the **[FILE]** button to exit the load operation mode. (The “FILE” indicators turn off.)

Deleting Song Files

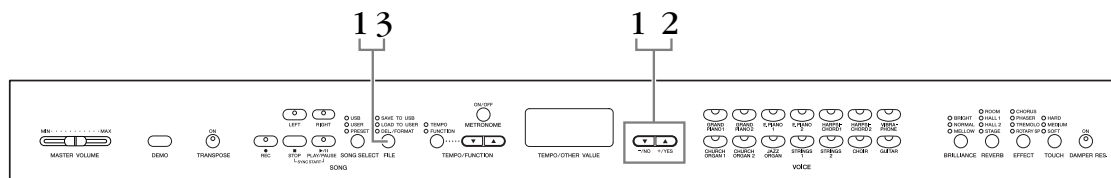

Procedure

1. Select a song file to be deleted.

Press the [FILE] button. (The “DEL/FORMAT” indicator lights.) Then, hold the [FILE] button, simultaneously press the [-/NO][+/YES] buttons to select a file to be deleted. Two types of files will be displayed in order:

- **Sxx**..... SMF songs
- **xxx**..... External songs (commercially available songs or songs which have been edited on a computer)

2. Delete the file.

After releasing the [FILE] button, “n y (no or yes)” appears in the display. If you want to delete the file, press the [+ /YES] button. After “n-y” appears in the display again to confirm whether you wish to delete the file or not, press the [+ /YES] button once more.

If you do not want to delete the song, press the [- /NO] button.

Notice

While the instrument is accessing data (such as during Save, Delete, Load and Format operations) or is mounting the USB storage device (shortly after the connection: until the LOAD TO USER LED flash stops), do NOT unplug the USB cable, do NOT remove the media from the device, and do NOT turn the power off to either devices. Doing so may corrupt the data on either or both devices.

3. Exit from the file operation mode.

Press the [FILE] button to exit the file operation mode. (The FILE indicators turn off.)

NOTE

Audition the song to be deleted before deleting. Songs cannot be played back after engaging the Delete mode.

NOTE

Only files which contain data will be displayed.

NOTE

The following types of songs cannot be deleted. If you try to delete the song, “Pro” (Protected) appears in the display.

- Protected songs (extension: Cxx, Exx or SME)
- Disklavier Piano Soft songs

NOTE

For SMF songs (Sxx), the song numbers are fixed and not changed by deleting files. However, the song numbers of External songs are not fixed and may be changed by deleting External songs.

Formatting the USB Storage Device

Notice

If data is already saved to the USB storage device, be careful not to format it. If you format the device, all the previously saved data will be deleted.

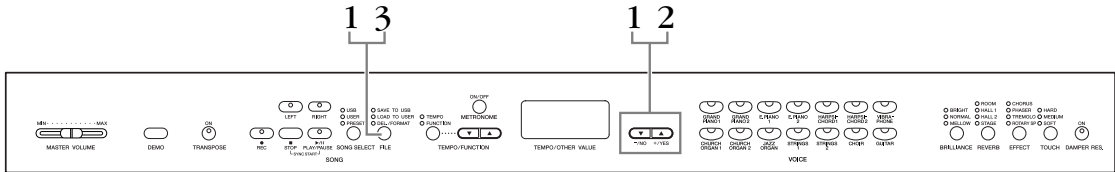

Procedure

1. Engage the format mode.

Press the **[FILE]** button. (The “DEL/ FORMAT” indicator lights.) Then, while holding the **[FILE]** button, simultaneously press the **[-/NO]** and **[+ /YES]** buttons. When “For” (Format) appears in the display, release the **[FILE]** button to display “n y” (no/yes).

2. Execute the format operation.

After “n y” (no/yes) appears in the display, press the **[+ /YES]** button. After “n-y” appears in the display again to confirm whether you wish to format the device or not, press the **[+ /YES]** button once more. If you do not want to format the device, press the **[-/NO]** button.

Notice

While the instrument is accessing data (such as during Save, Delete, Load and Format operations) or is mounting the USB storage device (shortly after the connection: until the LOAD TO USER LED flash stops), do NOT unplug the USB cable, do NOT remove the media from the device, and do NOT turn the power off to either devices. Doing so may corrupt the data on either or both devices.

3. Exit from the format mode.

Press the **[FILE]** button to exit the file operation mode. (The FILE indicators turn off.)

Handling the USB Storage Device (USB Flash Memory)

Precautions when using the USB [TO DEVICE] terminal

This instrument features a built-in **USB [TO DEVICE]** terminal. When connecting a USB device to the terminal, be sure to handle the USB device with care. Follow the important precautions below.

NOTE

For more information about the handling of USB devices, refer to the owner's manual of the USB device.

Compatible USB devices

USB storage devices (flash memory, floppy disk drive, hard disk drive, etc.)

The instrument does not necessarily support all commercially available USB devices. Yamaha cannot guarantee operation of USB devices that you purchase. Before purchasing a USB device for use with this instrument, please visit the following web page:

<http://music.yamaha.com/download/>

NOTE

Other USB devices such as a computer keyboard or mouse cannot be used.

Connecting USB device

When connecting a USB device to the **USB [TO DEVICE]** terminal, make sure that the connector on the device is appropriate and that it is connected in the proper direction.

Notice

When connecting a USB device to the **USB [TO DEVICE]** terminal on the top panel, remove it before closing the key cover. If the key cover is closed with the USB device connected, the USB device may be damaged.

Using USB Storage Devices

By connecting the instrument to a USB storage device, you can save data you've created to the connected device, as well as read data from the connected device.

NOTE

Although CD-R/RW drives can be used to read data to the instrument, they cannot be used for saving data.

The number of USB storage device to be used

Only one USB storage devices can be connected to the **USB [TO DEVICE]** terminal.

Formatting USB storage media

When a USB storage device is connected or media is inserted, a message may appear prompting you to format the device/media. If so, execute the Format operation (page 37).

Notice

The format operation overwrites any previously existing data. Make sure that the media you are formatting does not contain important data.

To protect your data (write-protect)

To prevent important data from being inadvertently erased, apply the write-protect provided with each storage device or media. If you are saving data to the USB storage device, make sure to disable write-protect.

Connecting/removing USB storage device

Before removing the media from the device, make sure that the instrument is not accessing data (such as in the Save, Copy and Delete operations).

Notice

Avoid frequently turning the power on/off to the USB storage device, or connecting/disconnecting the device too often. Doing so may result in the operation of the instrument "freezing" or hanging up. While the instrument is accessing data (such as during Save, Copy, Delete, Load and Format operations) or is mounting the USB storage device (shortly after the connection), do NOT unplug the USB connector, do NOT remove the media from the device, and do NOT turn the power off to either device. Doing so may corrupt the data on either or both devices.

To display the data in the USB storage device

To view the data of the USB storage device on the display, press the [SONG SELECT] button a few times until the “USB” indicator lights (page 42).

Backing up your data to a computer

■ Backing up the instrument data to a computer

Once you’ve saved data to a USB storage device, you can copy the data to the hard disk of your computer, then archive and organize the files as desired. Simply reconnect the device as shown below.

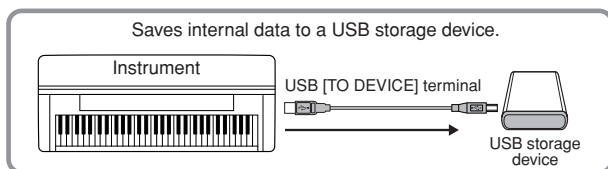

Disconnect the USB storage device from the instrument and connect it to the computer.

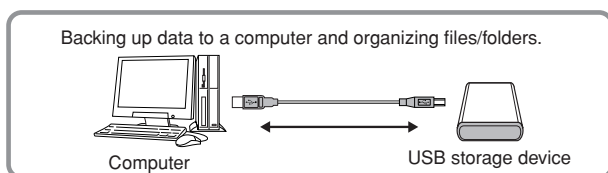

■ Copying files from a computer hard disk to a USB storage device

Files contained on the hard disk of a computer can be transferred to the instrument by first copying them to the storage media, then connecting/inserting the media to the instrument. Not only files created on the instrument itself but also Standard MIDI files created on other devices can be copied to a USB storage device from the hard disk of the computer. Once you’ve copied the data, connect the device to the USB [TO DEVICE] terminal of the instrument, and play back the data on the instrument.

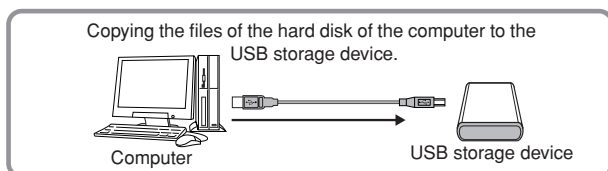

Disconnect the USB storage device from the computer and connect it to the instrument.

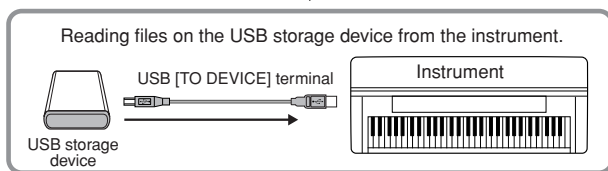

Playing Back Songs

You can play back songs recorded using the Record function (pages 27 – 32) or commercially available songs. You can also play the keyboard along with the playback.

- **The Demo Songs** page 15
Playing the voice demo tune.
- **50 Piano Preset Songs** page 16
50 Piano Preset Songs in the instrument.
- **User songs in the instrument** page 41
User songs which you recorded to the instrument by using the record function (pages 27 – 32).
- **External songs in the instrument** page 41
Songs transferred from a computer (including commercially available songs and songs which have been edited on a computer). Songs can be transferred (saved) to the instrument by using the Musicsoft Downloader software (page 53). The songs are saved to an area of the internal memory separate from the area for recorded User songs. Up to 255 songs can be played back on this instrument (numbers 001 – 255).
- **User Songs saved from the instrument in the USB storage device** page 42
SMF songs which have been saved from the instrument to a USB storage device (page 34).
- **External songs in the USB storage device** page 42
Commercially available songs or songs which have been edited on a computer, etc. and stored to a USB storage device. Up to 999 songs can be played back on this instrument (numbers 001 – 999).

Sequence formats that can be played

- **SMF (Standard MIDI File) Formats 0 and 1**
The SMF format is one of the most common and widely compatible sequence formats used for storing sequence data. There are two variations: Format 0 and Format 1. A large number of MIDI devices are compatible with SMF Format 0, and most commercially available MIDI sequence data is provided in SMF Format 0. The SMF format for sequence files allows you to exchange song data between different sequencers. User songs recorded in this instrument are saved as SMF Format 0.
- **ESEQ**
This sequence format is compatible with many of Yamaha's MIDI devices. This is a common format used with various Yamaha software.
Among ESEQ files, Disklavier Piano Soft songs can be played back on this instrument.

NOTE

When playing back songs containing various voices or parts (such as XG or GM songs), the voices may not sound correct or as intended on the original. You may be able to remedy this and make the playback sound more natural or appropriate by changing the Song Channel Selection setting (page 47) to "1&2," so that only channels 1 and 2 will play back.

NOTE

If the song cannot be selected or loaded, you may need to change the Character Code setting (page 50).

NOTE

Song data is not transmitted via the MIDI connections. However, channels 3 – 16 of Disklavier Piano Soft songs and non-protected External songs will be transmitted via the MIDI connections when the Song Channel Selection is set to "1&2" (page 47).

NOTE

For the USB storage device, folder directories on this instrument can be recognized up to two levels. However, the level is not displayed and song numbers 001 – 999 are displayed whichever level the song contains.

NOTE

If the metronome is being used during playback, the metronome will automatically stop when playback is stopped.

NOTE

If the REVERB type is changed via the panel controls during playback, both the playback and keyboard reverb effects will be changed.

NOTE

If the EFFECT type is changed via the panel controls during playback, the playback effect may be switched off in some cases.

Playing Back User/External Songs on the Instrument

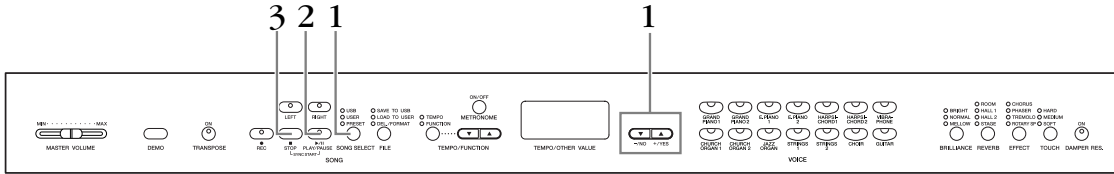

Procedure

1. Select the desired song.

Press the [SONG SELECT] button (the USER indicator lights). Then press the [-/NO] [+ /YES] buttons to select a song. The User songs are displayed as “Uxx*” and External songs in the instrument are displayed as “xxx.”

*The “U” indication in the User song name means “User.” The letters “xx” represent the song number.

2. Start playback.

Press the SONG [PLAY/PAUSE] button.

The current measure number appears on the display during playback.



- You can play the keyboard while the instrument is playing back a song. You can also play the notes in a voice different from the playback voice by selecting a voice from the panel.

Adjust the volume

Use the [MASTER VOLUME] slider to adjust the volume.

Adjust the tempo

You can use the [TEMPO/FUNCTION ▼, ▲] buttons to adjust the playback tempo as required before or during playback. The default tempo (the song’s original tempo) is set when you press the [▼] and [▲] buttons simultaneously.

3. Stop playback.

When playback is complete, the instrument automatically stops and locates the top of the song. To stop playback in the middle of a song, press the SONG [STOP] button. You can also pause playback by pressing the SONG [PLAY/PAUSE] button.

NOTE

User song playback cannot be started when the recorder contains no data.

NOTE

You can also enjoy playing duets with yourself by recording one part of a duet or a song for two pianos, then playing the other part while the recorded part plays back.

NOTE

If you have External songs in the instrument, you can use the repeat function.

ALL: Play all External songs in sequence.

rnd: Play all External songs continuously in random order.

NOTE

For instructions about how to load the songs from the computer (refer on page 53).

Playing Back User Songs from a USB Storage Device

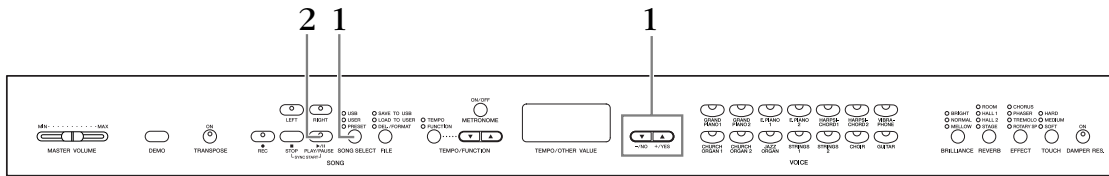

Procedure

1. Select the desired song in the USB storage device.

After making sure that the device is connected to the instrument, press the [SONG SELECT] button (the USB indicator lights). Then press the [-/NO] [+ / YES] buttons to select a number of the song you want to play (the number will appear on the LED display “Sxx*” or “xxx*”), or select the playing method RND* or ALL*.

*The “S” indication in the display represents “SMF” songs. The letters “xx” represent the song number.

*The “xxx” indication in the display represents External songs.

RND (r n d)*: Play all preset songs continuously in random order.

ALL*: Play all preset songs in sequence.

2. Start and stop playback.

Same as steps 2 and 3 in “Playing Back User/External Songs on the Instrument” on page 41.

Useful Playback Functions

Turning part playback on and off

When you select a song on the instrument, the indicators for parts that contain data (one of [RIGHT] [LEFT] or both) are lit in green. While the instrument is playing or stopped, pressing these part buttons turns off the indicators, and the data on those parts is not played. Pressing the part buttons toggles part playback on and off.

Starting playback automatically when you start playing the keyboard (Sync Start)

You can start playback as soon as you start playing the keyboard. This is called the “Sync Start” function.

To engage the Sync Start function, press the SONG [PLAY/PAUSE] button while holding down the SONG [STOP] button. The SONG [PLAY/PAUSE] lamp will flash at the current tempo.

(Repeat the previous operation to disengage the Sync Start function.)

Playback will then start as soon as you begin playing on the keyboard.

This function is useful when you wish to match the timing of the beginning of the playback sound and the start of your own performance.

Assigning the PLAY/PAUSE function to the left pedal

The left pedal can also be assigned to song play/pause operation via the “Left Pedal Mode” (page 47). This is convenient for starting playback of the song anytime after you have started playing.

NOTE

Parts can be turned on or off before or during playback.

TERMINOLOGY

Sync:

Synchronized; occurring at the same time

Detailed Settings — [FUNCTION]

You can set various parameters to make the best use of instrument functions, such as fine tuning the pitch or selecting a scale, etc.

The following parameters are available.

This instrument has seven main functions.

Some of these main functions consist of a set of sub-modes.

Parameter List

Function	Sub-Mode	Default setting	Display	Reference page	Backup Group
Fine tuning of the pitch	—	A3=440Hz	F1	45	
Selecting a scale	Scale	1 (Equal Temperament)	F2.1	45	F7.3
	Base Note	C	F2.2	45	
Dual mode functions	Dual Balance	Preset for each voice combination	F3.1	46	F7.1
	Dual Detune	Preset for each voice combination	F3.2	46	
	Voice 1 Octave Shift	Preset for each voice combination	F3.3	46	
	Voice 2 Octave Shift		F3.4	46	
	Voice 1 Effect Depth	Preset for each voice combination	F3.5	46	
	Voice 2 Effect Depth		F3.6	46	
	Reset	—	F3.7	46	
Other Functions	Left Pedal Mode	1 (Soft Pedal)	F4.1	47	F7.4
	Soft Pedal Effect Depth	3	F4.2	47	
	Song Channel Selection	ALL	F4.3	47	
Metronome volume	—	10	F5	47	F7.1
MIDI Functions	MIDI Transmit Channel Selection	1	F6.1	48	F7.2
	MIDI Receive Channel Selection	ALL	F6.2	48	
	Local Control ON/OFF	ON	F6.3	48	
	Program Change ON/OFF	ON	F6.4	48	
	Control Change ON/OFF	ON	F6.5	49	
	Panel/Status Transmit	—	F6.6	49	—
	Initial Setup Send	—	F6.7	49	—
Backup Functions	Voice	OFF	F7.1	50	*
	MIDI	ON	F7.2	50	*
	Tuning	ON	F7.3	50	*
	Others	ON	F7.4	50	*
Character Code	—	Int (International)	F7.5	50	*

*: Always backed up.

Basic Procedure in Function

Follow the steps below to use the functions.
 (If you become lost while using a function, return to this page and read the basic procedure.)

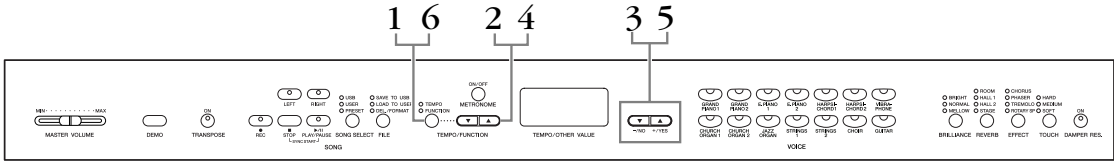

Procedure

1. Engage the Function mode.

Press the [TEMPO/FUNCTION] button so that its [FUNCTION] indicator lights. **F**** will appear on the display. (The indication of “**” varies depending on the status of the unit and usage.)

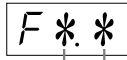

Desired function Sub-mode

2. Select a function.

Use the [TEMPO/FUNCTION ▼, ▲] buttons to select the desired function from F1 – F7.

When **F*y** (that include the sub-mode) is selected, go on to step 3.
 When F1 or F5 is selected (these have no sub-mode), go on to step 5.

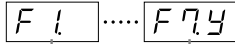

Desired function

3. Press the [+]/YES button to enter the sub-mode.

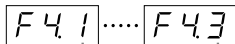

Sub-mode

4. Select a sub-mode.

Use the [TEMPO/FUNCTION ▼, ▲] buttons to select the desired sub-mode.

5. Use the [-]/NO and [+]/YES buttons to change the ON/OFF setting, select the type, or change the value.

The default setting (which is used when you first turn on the power to the instrument) is recalled by pressing the [-]/NO and [+]/YES buttons simultaneously.

6. Press the [TEMPO/FUNCTION] to exit the Function.

The [TEMPO] indicator lights.

NOTE

Functions cannot be selected during Demo/Song Select/ file operation mode or when the user song recorder is in operation.

NOTE

To exit the Function mode, press [FUNCTION] button any time.

NOTE

After you select the function, the current setting will be displayed when the [-]/NO or [+]/YES button is pressed for the first time.

About Each Function

F1. Fine Tuning of the Pitch

You can fine tune the pitch of the entire instrument. This function is useful when you play the instrument along with other instruments or CD music.

1. Engage the Function mode and select **[F1]**.
2. Use the **[-/NO]** and **[+/YES]** buttons to lower or raise the pitch of the A3 key in approximately 0.2 Hz increments.

The value appears two-digit number and one decimal place.

Ex. 440.2Hz is shown as 40.2 on the display.

Display	Value
[40.0]	440.0
[40.2]	440.2
[40.4]	440.4
[40.6]	440.6
[40.8]	440.8

Setting range:
427.0 – 453.0 (Hz)

Normal setting:
440.0 (Hz)

TERMINOLOGY

Hz (Hertz):

This unit of measurement refers to the frequency of a sound and represents the number of times a sound wave vibrates in a second.

F2. Selecting a Scale

You can select various scales. Equal Temperament is the most common contemporary piano tuning scale. However, history has known numerous other scales, many of which serve as the basis for certain genres of music. You can experience these tunings with the instrument.

Equal Temperament

One octave is divided into twelve equal intervals. Currently the most popular piano tuning scale.

Pure Major/Pure Minor

Based on natural overtones, three major chords using these scales produce a beautiful, pure sound.

Pythagorean

This scale, designed by Pythagoras, a Greek philosopher, is based on the interval of a perfect 5th.

The 3rd produces swells, but the 4th and 5th are beautiful and suitable for some leads.

Mean Tone

This scale is an improvement of the Pythagorean in that the swell of the 3rd has been eliminated. The scale became popular during the late 16th century through the late 18th century, and was used by Handel.

Werckmeister/Kirnberger

These scales combine Mean Tone and Pythagorean in different ways. With these scales, modulation changes the impression and feel of the songs. They were often used in the era of Bach and Beethoven. They are often used today to reproduce the music of that era on harpsichords.

1. Engage the Function mode and select **[F24]**.
2. Press the **[+/YES]** button to engage the scale function's sub-mode, then use the **[TEMPO/FUNCTION ▼, ▲]** buttons to select the desired sub-mode. Press the **[-/NO]** and **[+/YES]** buttons to select the number of the desired tuning.

Sub-mode

[F21] Scale

Setting range:

- 1: Equal Temperament
- 2: Pure Major
- 3: Pure Minor
- 4: Pythagorean
- 5: Mean Tone
- 6: Werckmeister
- 7: Kirnberger

Normal setting: 1: Equal Temperament

[F22] Base Note

If you select a scale other than Equal Temperament, you need to specify the root. (You can specify the root note with Equal Temperament selected, but it is not effective. The base note setting is effective for tunings other than the Equal Temperament tuning.)

Setting range: C, C[♯], D, E^b, E, F, F[♯], G, A^b, A, B^b, B

Normal setting: C

- Root indication example

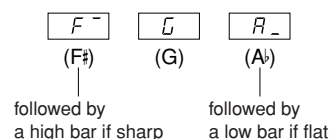

F3. Dual Mode Functions

You can set various parameters for Dual mode to optimize the settings for the songs you play, such as adjusting the volume balance between two voices.

Dual mode function settings are set individually for each voice combination.

1. Select the voices in Dual mode, then engage the Function mode and select **[F34]**.
2. Press the [+ / YES] button to engage the Dual mode function's sub-mode, then use the [TEMPO/FUNCTION ▼, ▲] buttons to select the desired sub-mode. Press the [- / NO] [+ / YES] button to assign values.

NOTE

If Dual mode is not engaged, **[F3-]** will appear instead of **[F34]** and you will be unable to select Dual mode functions. In this case, you can switch to the Dual mode by selecting two voices.

Sub-mode

[F31] Dual Balance

Setting range: 0 – 20 (A setting of “10” produces an equal balance between the two Dual mode voices. Settings below “10” increase the volume of Voice 2 in relation to Voice 1, and settings above “10” increase the volume of Voice 1 in relation to Voice 2.)

Normal setting: Different for each voice combination. You can set one voice as the main voice, and another voice as a softer, mixed voice.

[F32] Dual Detune

Setting range: -20 – 0 – 20 (With positive values, the pitch of Voice 1 is raised and the pitch of Voice 2 is lowered. With negative values, the pitch of Voice 1 is lowered and the pitch of Voice 2 is raised.)

NOTE

The available setting range is wider in the lower range (± 60 cents for A -1), and narrower in the higher range (± 5 cents for C7). (100 cents equal one semitone.)

Normal setting: Different for each voice combination.

Detune Voice 1 and Voice 2 for Dual mode to create a thicker sound.

[F33] Voice 1 Octave Shift

[F34] Voice 2 Octave Shift

Setting range: -1, 0, 1

Normal setting: Different for each voice combination.

You can shift the pitch up and down in octave steps for Voice 1 and Voice 2 independently. Depending on which voices you combine in Dual mode, the combination may sound better if one of the voices is shifted up or down an octave.

[F35] Voice 1 Effect Depth

[F36] Voice 2 Effect Depth

Setting range: 0 – 20

Normal setting: Different for each voice combination.

These functions make it possible to individually set the depth of the effect for Voices 1 and 2 for Dual mode. (The effect depth settings cannot be changed unless the [EFFECT] is ON. Function mode must be exited before the [EFFECT] can be turned ON.)

- “Voice 1” and “Voice 2” are explained on page 25.

[F37] Reset

This function resets all Dual mode functions to their default values. Press the [+ / YES] button to reset the values.

NOTE

SHORTCUT:

You can jump directly to the Dual mode functions **[F3*]** by pressing the [TEMPO/FUNCTION] button while holding the two Dual mode voice buttons.

To exit Function mode, you still need to press the [TEMPO/FUNCTION] button so that the TEMPO indicator lights up.

F4. Other Functions

This section provides a variety of other functions, including letting you assign the operation of the left pedal to one of several modes, and allowing you to select specific song channels for playback.

1. Engage the Function mode and select **[F4]**.
2. Press the [+ / YES] button to engage the other functions' sub-mode, then use the [TEMPO / FUNCTION ▼, ▲] buttons to select the desired sub-mode.
Press the [- / NO] or [+ / YES] button to select the desired pedal function or assign the values.

Sub-mode

[F4.1] Left Pedal Mode

Setting range:

1. Soft Pedal
The soft pedal reduces the volume and slightly changes the timbre of notes played while the pedal is pressed. The soft pedal will not affect notes that are already playing.
2. Song Play/Pause
This mode allows you to start or pause song playback. In this mode, the Left Pedal functions in the same manner as the **SONG [PLAY/PAUSE]** button on the panel.

Normal setting: 1 (Soft Pedal)

[F4.2] Soft Pedal Effect Depth

Setting range: 1 – 5

Normal setting: 3

This function sets the depth of the soft pedal effect.

[F4.3] Song Channel Selection

Setting range: ALL, 1&2

Normal setting: ALL

The setting here only affects Disklavier Piano Soft songs, and non-protected External songs. You can specify which song channels will play back on this instrument. When "ALL" is selected, channels 1 – 16 will be played back. When "1&2" is selected, only channels 1 and 2 will be played back, while channels 3 – 16 will be transmitted via MIDI.

F5. Metronome Volume

You can change the volume of the metronome sound.

Use this function to adjust the metronome volume.

1. Engage the Function mode and select **[F5]**.
2. Use the [- / NO] and [+ / YES] buttons to set the metronome volume as required.

Setting range: 1 – 20

Normal setting: 10

NOTE

SHORTCUT:

You can jump directly to the metronome functions **[F5]** by pressing the **[TEMPO/FUNCTION]** button while holding the **METRONOME [ON/OFF]** button.

To exit the Function mode, you still need to press the **[TEMPO/FUNCTION]** button so that the TEMPO indicator lights up.

F6. MIDI Functions

You can make detailed adjustments to MIDI settings.

For more information about MIDI, see the “About MIDI” section (page 51).

1. Engage the Function mode and select **[F6.4]**.
2. Press the [+ / YES] button to engage the MIDI function's sub-mode, then use the [TEMPO / FUNCTION ▼, ▲] buttons to select the desired sub-mode. Press the [- / NO] or [+ / YES] button to set a selected parameter.

Sub-mode

[F6.1] MIDI Transmit Channel Selection

In any MIDI control setup, the MIDI channels of the transmitting and receiving equipment must be matched for proper data transfer.

This parameter enables you to specify the channel on which the instrument transmits MIDI data.

Setting range: 1 – 16, OFF (not transmitted)

Normal setting: 1

NOTE

In Dual mode, Voice 1 data is transmitted on its specified channel and Voice 2 data is transmitted on the next greater channel number relative to the specified channel. In this mode, no data is transmitted if the transmit channel is set to “OFF.”

NOTE

Song data is not transmitted via the MIDI connections. However, channels 3 – 16 of Disklavier Piano Soft songs, and non-protected External songs will be transmitted via the MIDI connections depending on the Song Channel Selection setting (page 47).

[F6.2] MIDI Receive Channel Selection

In any MIDI control setup, the MIDI channels of the transmitting and receiving equipment must be matched for proper data transfer. This parameter enables you to specify the channel on which the instrument receives MIDI data.

Setting range: ALL, 1&2, 1 – 16

Normal setting: ALL

NOTE

ALL:

“Multi-timbre” Receive mode. This allows simultaneous reception of different parts on all 16 MIDI channels, enabling the instrument to play multi-channel song data received from F6.6 or sequencer.

1&2:

“1&2” Receive mode. This allows simultaneous reception on channels 1 and 2 only, enabling the instrument to play 1 and 2 channel song data received from a music computer or sequencer.

NOTE

Program change and other like channel messages received will not affect the instrument's panel settings or the notes you play on the keyboard.

NOTE

No MIDI reception occurs when Demo mode is engaged or during file operations.

[F6.3] Local Control ON/OFF

“Local Control” refers to the fact that, normally, the keyboard controls its internal tone generator, allowing the internal voices to be played directly from the keyboard. This situation is “Local Control On,” since the internal tone generator is controlled locally by its own keyboard. Local control can be turned OFF, however, so that the keyboard does not play the internal voices, but the appropriate MIDI information is still transmitted via the MIDI OUT terminal when notes are played on the keyboard. At the same time, the internal tone generator responds to MIDI information received via the MIDI IN terminal.

Setting range: ON/OFF

Normal setting: ON

[F6.4] Program Change ON/OFF

Normally the instrument will respond to MIDI program change numbers received from an external keyboard or other MIDI device, causing the correspondingly-numbered voice to be selected on the corresponding channel (the keyboard voice does not change). The instrument will normally also send a MIDI program change number whenever one of its voices is selected, causing the correspondingly-numbered voice or program to be selected on the external MIDI device if the device is set up to receive and respond to MIDI program change numbers. This function makes it possible to cancel program change number reception and transmission so that voices can be selected on the instrument without affecting the external MIDI device.

NOTE

For information on program change numbers for each of the Instrument's voices, Refer to MIDI Data Format on the web site. <http://www.yamaha.co.jp/manual/>

Setting range: ON/OFF

Normal setting: ON

[F55] Control Change ON/OFF

Normally the instrument will respond to MIDI control change data received from an external MIDI device or keyboard, causing the voice on the corresponding channel to be affected by pedal and other “control” settings received from the controlling device (the keyboard voice is not affected).

The instrument also transmits MIDI control change information when the pedal or other appropriate controls are operated.

This function makes it possible to cancel control change data reception and transmission so that, for example, the instrument’s pedal and other controls can be operated without affecting an external MIDI device.

NOTE

For information on control changes that can be used with the instrument, refer to the MIDI Data Format in our manual library at the following website.

<http://www.yamaha.co.jp/manual/>

Setting range: ON/OFF
Normal setting: ON

[F56] Panel/Status Transmit

This function causes all the current instrument panel settings (selected voice, etc.) to be transmitted via the MIDI OUT terminal.

TERMINOLOGY**Setup Data:**

Data that contains a set of panel settings for the instrument.

Procedure

1. Set up the panel controls as desired.
2. Connect the instrument to a sequencer via MIDI, and set up the sequencer so it can receive the setup data.
3. Engage the Function mode and select [F56].
4. Press the [+ / YES] button to transmit the panel/status data.

[End] will appear on the LED display when the data has been successfully transmitted.

NOTE

For a list of the “Panel Data Contents” transmitted by this function, refer to our manual library at the following website.

<http://www.yamaha.co.jp/manual/>

NOTE**Receiving the transmitted data:**

1. Connect the instrument via MIDI to the device to which the setup data was transmitted previously.
2. Start sending the setup data from the device.

The instrument automatically receives the setup data, which will be reflected in the panel settings.

(For the data to be accepted, the instrument that receives the setup data should be the same model as the one that transmitted the setup data to the sequencer.)

NOTE

For more information on transmitting and receiving setup data via MIDI, refer to the owner’s manual for the connected MIDI device.

[F57] Initial Setup Send

This function lets you send the data of the panel settings to a computer. By transmitting the panel settings and recording them on the MIDI sequence recorder prior to the actual performance data, the instrument will be automatically restored to the same settings when the performance is played back. You can also use this function to change the settings of a connected tone generator to the same settings as the instrument.

Procedure

1. Set up the panel controls as desired.
2. Connect the instrument to a sequencer via MIDI, and set up the sequencer so it can receive the setup data.
3. Engage the Function mode and select [F57].
4. Press the [+ / YES] button to transmit the panel/status data.

[End] will appear on the LED display when the data has been successfully transmitted.

The following data can be sent.

- Voice selection
- [REVERB] type
- [REVERB] depth
- [EFFECT] type
- [EFFECT] depth
- Tuning (F1)
- Dual detune (F3.2)

F7. Backup Functions

TERMINOLOGY

Backup:

You can back up some settings, such as voice selection and reverb type, so that they will not be lost when you turn off the power to the instrument.

If the backup function is turned on, the settings at power off are effective. If the backup function is turned off, the settings in memory are erased when you turn off the power. In this case, when you turn on the power to the unit, the default settings (the initial settings) will be used. (The factory setting default list is found on page 65.)

However, the backup settings themselves, the contents of the user song recorder memory and character code settings are always backed up.

You can turn the backup function on or off for each function group (each of the following sub-mode functions).

1. Engage the Function mode and select **[F74]**.

2. Press the [+ / YES] button to engage the backup function's sub-mode, then use the [TEMPO / FUNCTION ▼, ▲] buttons to select the desired sub-mode.

Press the [- / NO] or [+ / YES] button to turn the backup function on or off.

Sub-mode

[F71] Voice

[F72] MIDI

[F73] Tuning

[F74] Others

Setting range: ON/OFF

Normal setting: Voice: OFF
MIDI – Others: ON

Description of sub-modes

[F71] Voice

- Voice (Keyboard, Dual)
- Dual (ON/OFF, Voice, and Dual Functions for each voice combination)
- Reverb (ON/OFF, Type, and Depth for each voice)
- Effect (ON/OFF, Type, and Depth for each voice)
- Touch Sensitivity (including the FIXED volume)
- Metronome (Beat, Volume < **[F5]** settings >)

[F72] MIDI

The MIDI functions (**[F5*]** settings)
(expect for the **[F55]** and **[F57]**)

[F73] Tuning

- Transpose
- Tuning (**[F1]** settings)
- Scale (including base note) (**[F2*]** settings)

[F74] Others

- Other functions (**[F4*]** settings)
- BRILLIANCE setting
- DAMPER RES. ON/OFF and Depth

F7.5 Character Code

If the song cannot be loaded, you may need to change the character code setting.

Setting range: Int (English)/JA (Japanese)

Normal setting: Int

Connections

Connectors

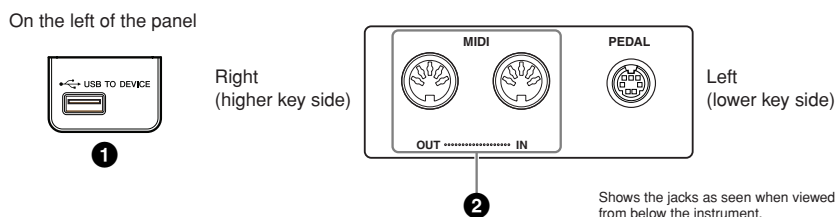

1 USB [TO DEVICE] terminal

This terminal allows connection to USB storage devices. Refer to “Handling the USB Storage Device” on page 38.

2 MIDI [IN] [OUT] terminals

Use MIDI cables to connect external MIDI devices to these connectors.

MIDI [IN]: Receives MIDI data.

MIDI [OUT]: Transmits MIDI data.

About MIDI

MIDI (Musical Instrument Digital Interface) is a standard format for data transmission/reception. It enables the transfer of performance data and commands between MIDI devices and personal computers. Using MIDI, you can control a connected MIDI device from the instrument, or control the instrument from a connected MIDI device or computer.

NOTE

MIDI performance data and commands are transferred in the form of numeric values.

NOTE

Since MIDI data that can be transmitted or received varies depending on the type of MIDI device, check the “MIDI Implementation Chart” to find out what MIDI data and commands your devices can transmit or receive. Refer to the MIDI Implementation Chart in the Data Format on the website.

For information on how to access and obtain the Data Format list, see page 6.

Direct URL:

<http://www.yamaha.co.jp/manual/>

Connecting a Personal Computer

By connecting a computer to the MIDI terminals, you can transfer data between the instrument and the computer via MIDI. To do this, install the USB MIDI interface driver and Musicsoft Downloader software.

There are two ways you can connect the instrument to a computer:

1. Connecting the USB port on the computer to the instrument via a USB MIDI interface.
2. Using a MIDI interface and the instrument's MIDI terminals.

For more information, see below.

Notice

When connecting the instrument to a computer, first turn off the power to both the instrument and the computer before connecting any cables. After making connections, turn on the power to the computer first, then to the instrument.

Connecting the USB port on the computer to the instrument via a USB MIDI interface

Use a USB MIDI interface device to connect the USB port on your computer to the instrument's MIDI terminals.

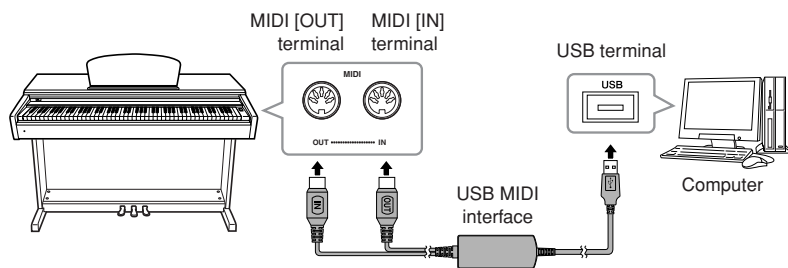

Using a MIDI interface and the instrument's MIDI terminals

Use a MIDI interface device to connect a computer to the instrument using MIDI cables.

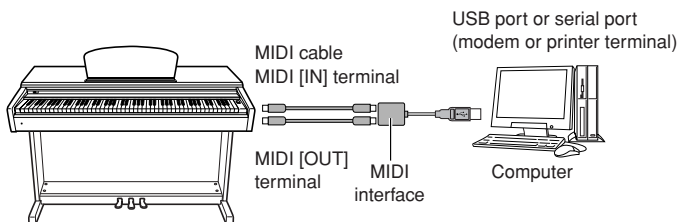

NOTE

Optional USB MIDI interface
UX16

TERMINOLOGY

Driver:

A driver is software that provides a data-transfer interface between the computer's operating system and a connected hardware device.

NOTE

You can download the USB MIDI interface driver and Musicsoft Downloader (MSD). Please check the following URL for the latest version.
<http://music.yamaha.com/download/>

NOTE

For information on setting up your sequence software, refer to the owner's manual of the relevant software.

Transmitting Song Data between the Computer and the Instrument

In addition to the demo songs and the 50 piano preset songs stored in this instrument, you can play data for other song by loading it from a connected computer. To be able to use this function, you must first download Musicsoft Downloader from Yamaha website, and install it on your computer.

<http://music.yamaha.com/download/>

Please visit the URL above to get the information on the computer system requirement for Musicsoft Downloader.

For more information on transferring data, please refer to “Transferring Data Between the Computer and Instrument (for unprotected data)” in the Help file that came with Musicsoft Downloader.

Loading Song Data from a Computer to the Instrument

You can load piano song data from a computer to this instrument. Also, after you record your performance on this instrument and save the recording to a computer, you can load the recording back to the instrument.

This instrument can read MIDI data in SMF Format 0. However, if such data includes any information for functions that are not supported by this instrument, the instrument will not play the data correctly.

For more information on loading song data from a computer to this instrument, please refer to “Transferring Data Between the Computer and Instrument (for unprotected data)” in the Help file that came with Musicsoft Downloader.

Requirements for song data that can be loaded from a computer to this instrument

• Songs	: user songs (loaded from instrument), SMF Format 0 & 1 songs
• Maximum data size	: 939KB
• Data format	: SMF Format 0 & 1
	: Backup data (loaded from instrument)
	File name
	10YDP.BUP

You can play the loaded Songs (page 41).

Notice

Do not turn off the power to this instrument or unplug the instrument during data transmission. Otherwise, the data being transmitted will not be saved. Furthermore, flash memory operation may become unstable, causing the entire memory to be erased when you turn the power to the instrument on or off.

Transmitting Song Data from the Instrument to a Computer

Musicsoft Downloader enables you to transfer the user song in this instrument to a computer. For more information on transferring song data from this instrument to a computer, please refer to “Transferring Data Between the Computer and Instrument (for unprotected data)” in the Help file that came with Musicsoft Downloader.

Data you can transfer from this instrument to a computer

• User song	: your recorded songs
• Back up data	: panel settings
• Song data (once it has been loaded from the computer)	

NOTE

You can download free Musicsoft Downloader from the Yamaha website.

NOTE

Do not manually change the file name by using a computer; doing so will render the file unable for loading on the instrument.

NOTE

SMF (Standard MIDI File)

This file features a popular sequence format (for recording performance data). This file is sometimes called a “MIDI file.” The file extension is MID.

You can play the SMF format song using music software or a sequencer that supports SMF. This instrument also supports SMF.

NOTE

Before you use this instrument, close the Musicsoft Downloader window and quit the application.

Backing up Data and Initializing the data

Data Backup

For maximum data security Yamaha recommends that you save your important data to your computer by using the application Musicsoft Downloader (MSD). This provides a convenient backup if the internal memory is damaged.

Data that can be saved

- **Panel settings**

Panel settings are the same data that can be backed up using the Backup Functions (page 50). You can save the panel settings and recorded User songs as one file.

- **Recorded User songs**

- **External songs received via computer.**

This includes external songs saved from the computer by using Musicsoft Downloader.

Procedure

1. Install the USB MIDI driver and the MSD to your computer (Windows), then connect the computer and the instrument.

For connection, see page 52.

2. Move the data to the computer.

By using the MSD, save the “10YDP.BUP” file from “System Drive” under “Electronic Musical Instruments” to the computer.

The “10YDP.BUP” file contains the panel settings. Also, if you store recorded User songs and the external songs in the instrument from the computer, move the songs from “Flash Memory” under “Electronic Musical Instruments” to the computer via the MSD.

For instruction on using the MSD, see the Help in the MSD.

To recall the settings and load the songs to the instrument, move the “10YDP.BUP” file and the External songs under the folders to which you saved the files.

Initializing the data

Notice

When you initialize the data, all panel settings and song data will be erased and reset to the default settings. Yamaha recommends you that you back up the data before initializing.

Turn off the power to the instrument. Then turn the power on while holding the C7 key (highest key).

Notice

Do not turn off the power to this instrument while data in internal memory is being initialized (in other words, while the “CLr” indication is shown). Doing so may corrupt the all data on the instrument.

NOTE

You can download the USB MIDI interface driver and Musicsoft Downloader (MSD). Please check the following URL for the latest version.
<http://music.yamaha.com/download/>

NOTE

When MSD is started on a computer connected to the instrument, “con (computer connection)” appears in the display. When this indication appears, you cannot operate the instrument.

NOTE

The Musicsoft Downloader cannot be used when the instrument is in the following state:

- During Demo mode.
- During song playback.
- During Record mode.
- During file operation (one of the [FILE] button indicators is lit).

NOTE

The panel settings and User songs (10YDP.BUP file) remain in the instrument after being saved to the computer.

Message List

Message	Comment
CLr	<p>Displayed after factory presets are recalled.</p> <p>Notice Do not turn off the power of the instrument when "CLr" appears in the display. Doing so may delete all song data in the instrument, including external songs (page 41).</p>
con	Displayed when Musicsoft Downloader is started on a computer connected to the instrument. When this message appears, you cannot operate the instrument.
E01	Indicates failure in accessing the USB storage device because the device or media is damaged, or because the USB storage device is not recognized by the instrument.
E02	Displayed when the song data is damaged or not recognized.
E04	Indicates that the song data is too large to be loaded.
End	Displayed when the current operation is completed.
Err	Displayed when the MIDI/USB cable is disconnected while starting Musicsoft Downloader on a computer connected to the instrument.
FCL	<p>Indicates that internal memory has been cleaned up. Recorded songs, panel settings and external songs which have been loaded from a computer are cleared, because the power has been turned off before the song save or load operations were completed.</p> <p>Notice Do not turn off the power of the instrument when "FCL" appears in the display.</p>
For	Indicates that the instrument has engaged format mode for the USB storage device.
FUL	Displayed when internal memory becomes full during song recording.
	Displayed when the USB storage device becomes full and the song cannot be saved.
	Displayed when the total amount of files has become too large.
Lod	Displayed when a protected song is loading.
n y	Confirms whether each operation is executed or not.
n~y	Reconfirms whether the overwriting, delete or format operation is executed or not.
Pro	Indicates that the USB storage device or media is protected.
UnF	Indicates the inserted USB storage device has not been formatted.

Troubleshooting

Problem	Possible Cause and Solution
The instrument does not turn on.	The instrument has not been plugged in properly. Securely insert the female plug into the socket on the instrument, and the male plug into a proper AC outlet (page 13).
Noise is heard from the speakers or headphones.	The noise may be due to interference caused by the use of a mobile phone in close proximity to the instrument. Turn off the mobile phone, or use it further away from the instrument.
The overall volume is low, or no sound is heard.	<ul style="list-style-type: none"> • The Master Volume is set too low; set it to an appropriate level using the [MASTER VOLUME] control. • Make sure a pair of headphones is not connected to the headphones jack (when the SPEAKER switch is set to the "NORMAL" position). If the SPEAKER switch is set to the "OFF" position, set it to "NORMAL" or "ON" (page 14). • Make sure that Local Control (page 48) is ON.
The speakers do not switch off when a pair of headphones is connected.	The SPEAKER switch may be switched "ON." Set the SPEAKER switch to the "NORMAL" position (page 14).
The damper pedal has no effect.	The pedal cord may not be securely connected to the [PEDAL] jack. Be sure to insert the pedal cord all the way until the metal part of the cord plug disappears from view (page 60).
The damper pedal has little effect.	The damper pedal was pressed when the power was turned on. This is not a malfunction; release the pedal and press it again to reset the function.
Even though a USB storage device is connected, the SONG SELECT "USB" indicator does not turn on when pressing the [SONG SELECT] button.	<p>The USB storage device may not be recognized by the instrument, depending on the device itself or the timing of the recognition.</p> <ol style="list-style-type: none"> 1. Check that the device is not damaged. Check that the FILE "LOAD TO USER" indicator flashes after connecting the USB storage device. If the indicator does not flash, the device may be damaged. 2. Check that the compatibility of the device has been confirmed by Yamaha (page 38). 3. Select SONG SELECT "USB" again. It may take a while for the instrument to recognize the USB storage device. Press the [SONG SELECT] button again to turn the "USB" indicator on.
The USB storage device has hung up (stopped).	<ul style="list-style-type: none"> • The USB storage device is not compatible with the instrument. Only use the devices whose compatibility has been confirmed by Yamaha (page 38). • Turn the instrument off and disconnect the device, then turn it back on and reconnect the device.
The three LEDs of "SAVE TO USB," "LOAD TO USER" and "DEL/FORMAT" at the [FILE] button flash simultaneously when a storage device is connected.	Disconnect the USB storage device and turn the power of the instrument off. The USB storage device is not compatible with the instrument.
The three LEDs of "SAVE TO USB," "LOAD TO USER" and "DEL/FORMAT" at the [FILE] button flash simultaneously for five seconds when the USB storage device is operated.	Try disconnect the USB storage device once, then reconnect it.
Nothing is indicated in the LED display.	Press the [-/NO] or [+YES] button and try again the operation again.

Options

BC-100 Bench

A comfortable bench styled to match your Yamaha digital piano.

HPE-150 Stereo Headphones

High-performance lightweight dynamic headphones with extra-soft ear pads.

UX16 USB-MIDI interface

Preset Voice List

○: Yes
—: No

Voice Name	Stereo Sampling	Touch Response	Dynamic Sampling ^{*1}	Key-Off Sampling ^{*2}	Voice Descriptions
GRANDPIANO 1	○	○	○	—	Recorded samples from a full concert grand piano. Perfect for classical compositions as well as any other style that requires acoustic piano.
GRANDPIANO 2	○	○	—	—	Spacious and clear piano with bright reverb. Good for popular music.
E.PIANO 1	—	○	○	—	An electronic piano sound created by FM synthesis. Good for standard popular music.
E.PIANO 2	—	○	○	○	The sound of an electric piano using hammer-struck metallic "tines." Soft tone when played lightly, and an aggressive tone when played hard.
HARPSICHORD 1	○	—	—	○	The definitive instrument for baroque music. Since harpsichord uses plucked strings, there is no touch response. There is, however, a characteristic additional sound when the keys are released.
HARPSICHORD 2	○	—	—	○	Mixes the same voice an octave higher for a more brilliant tone.
VIBRAPHONE	○	○	○	—	Vibraphone played with relatively soft mallets. The tone becomes more metallic the harder you play.
CHURCH ORGAN 1	○	—	—	—	This is a typical pipe organ sound (8 feet + 4 feet + 2 feet). Good for sacred music from the Baroque period.
CHURCH ORGAN 2	○	—	—	—	This is the organ's full coupler sound often associated with Bach's "Toccatina and Fugue."
JAZZ ORGAN	—	—	—	—	The sound of a "tonewheel" type electric organ. Often heard in jazz and rock idioms.
STRINGS 1	○	○	—	—	Stereo-sampled, large-scale strings ensemble with realistic reverb. Try combining this voice with piano in the DUAL mode.
STRINGS 2	○	○	—	—	Spacious strings ensemble with a slow attack. Try combining this voice with a piano or electric piano in the DUAL mode.
CHOIR	—	○	—	—	A big, spacious choir voice. Perfect for creating rich harmonies in slow pieces.
GUITAR	○	○	○	—	Warm and natural-sounding nylon guitar. Enjoy the quiet ambience of nylon strings.

*1. Dynamic Sampling provides multiple velocity-switched samples to accurately simulate the timbral response of an acoustic instrument.

*2. Contains a very subtle sample that is produced when the keys are released.

Demo Song List

Voice Name	Title	Composer
GRAND PIANO1	Salut d'amour, op.12	E. Elgar
HARPSICHORD1	Concerto a cembalo obbligato, 2 violini, viola e continuo No.7, BWV.1058	J. S. Bach
HARPSICHORD2	Gigue, Französische Suiten Nr.5, BWV.816	
CHURCH ORGAN1	Herr Christ, der ein'ge Gottes-Sohn, BWV.601	
CHURCH ORGAN2	Triosonate Nr.6, BWV.530	

The demonstration pieces listed above are short rearranged excerpts of the original compositions. All other songs are original (©2010 Yamaha Corporation).

Keyboard Stand Assembly

⚠ CAUTION

- Assemble the stand on a hard and flat floor with ample space.
- Be careful not to confuse parts, and be sure to install all parts in the correct orientation. Please assemble the unit in accordance with the sequence given below.
- Assembly should be carried out by at least two persons.
- Be sure to use only the included screws of the specified sizes. Do not use any other screws. Use of incorrect screws can cause damage or malfunction of the product.
- Be sure to tighten all screws upon completing assembly of the unit.
- To disassemble the unit, reverse the assembly sequence given below.

Have a Phillips-head (+) screwdriver of the appropriate size ready.

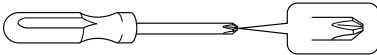

Remove all parts from the package and make sure you have all of the items.

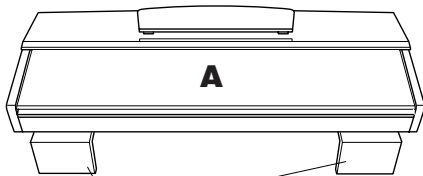

Foamed styrol pads
Remove foamed styrol pads from the package, position them on the floor, then place A on top of them. Position the pads so that they will not hide the connectors on the bottom of A.

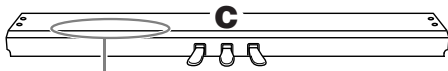

A bundled pedal cord is attached to the reverse side.

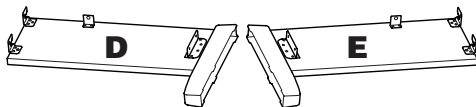

Assembly Parts

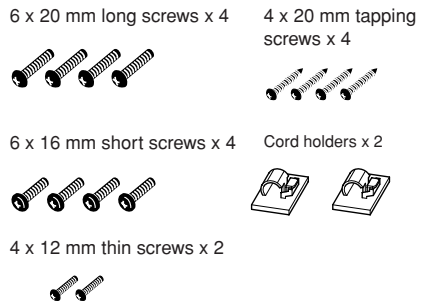

Headphone hanger

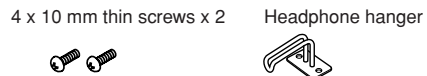

Power cord



Adjuster (x 1)

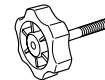

1. Attach the adjuster to C.

1-1 Align the tip of the adjuster with the screw hole, then screw in the adjuster all the way until it stops turning.

You will adjust the height of the adjuster in Step 8.

1-2 Untie and straighten out the bundled cord. Don't discard the vinyl tie, you'll need it later in Step 7.

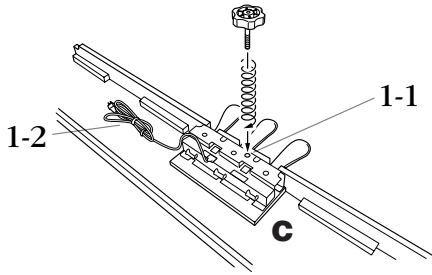

2. Attach (finger-tighten) D and E to C.

2-1 Align D and E with each end of C.

2-2 Attach D and E to C by finger-tightening the long screws (6 x 20mm).

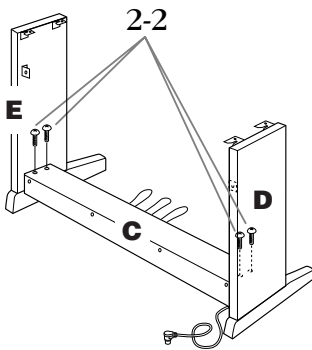

3. Attach B.

3-1 Place the lower side of B on each foot of D and E, then attach the upper side to D and E.

3-2 Attach the top of B to D and E by finger-tightening the thin screws (4 x 12mm).

3-3 While pushing the lower outside part of D and E towards each other, secure the bottom of B at each end using two tapping screws (4 x 20mm).

3-4 Insert the other two tapping screws (4 x 20mm) into the other two screw holes to secure B.

3-5 While pushing D and E towards each other, securely tighten the screws that were finger-tightened in Step 3-2.

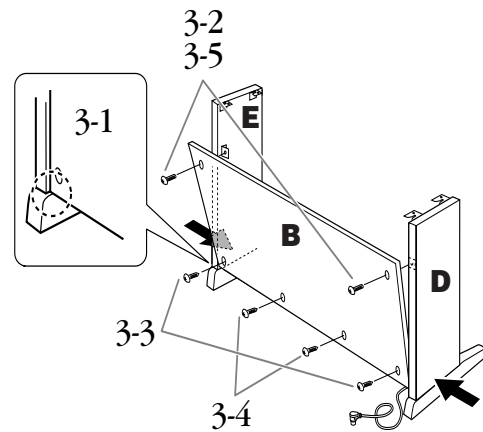

4. Secure C.

Securely tighten the screws on C that were attached in Step 2-2.

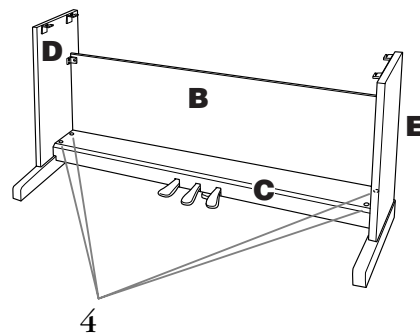

5. Mount A.

Place your hands at least 10 cm from either end of A when positioning it.

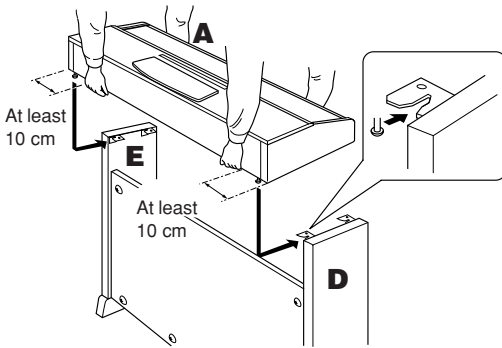

6. Secure A.

6-1 Adjust the position of A so that the left and right ends of A will project beyond D and E equally when seen from the front.

6-2 Secure A by tightening the short screws (6 x 16mm) from the front.

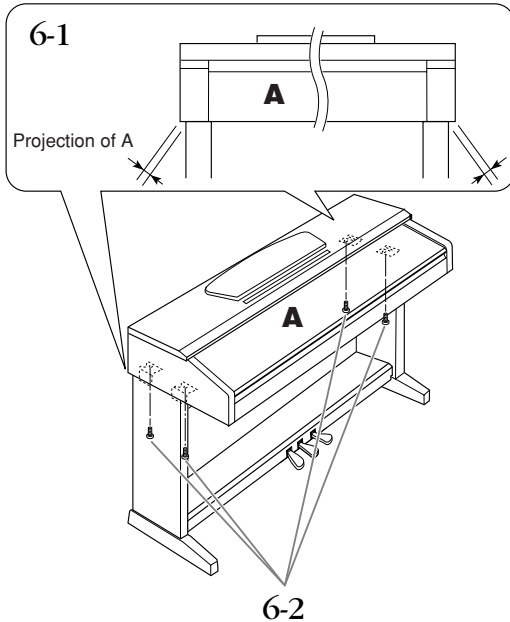

7. Connect the pedal cord and the power cord.

7-1 Insert the pedal cord plug to the pedal connector from the rear.

7-2 Attach the cord holders to B, then clip the cord into the holders.

7-3 Use a vinyl tie to bundle the pedal cord.

7-4 For models that feature a voltage selector: Set the voltage selector to an appropriate voltage.

Voltage Selector

Before connecting the AC power cord, check the setting of the voltage selector which is provided in some areas. To set the selector for 110V, 127V, 220V or 240V main voltages, use a "minus" screwdriver to rotate the selector dial so that the correct voltage for your region appears next to the pointer on the panel. The voltage selector is set at 240V when the unit is initially shipped. After the proper voltage has been selected, connect the AC power cord to the AC INLET and an AC wall outlet. A plug adaptor may be also provided in some areas to match the pin configuration of the AC wall outlets in your area.

⚠ WARNING

An improper voltage setting can cause serious damage to this instrument or result in improper operation.

7-5 Insert the AC power cord plug into the AC INLET.

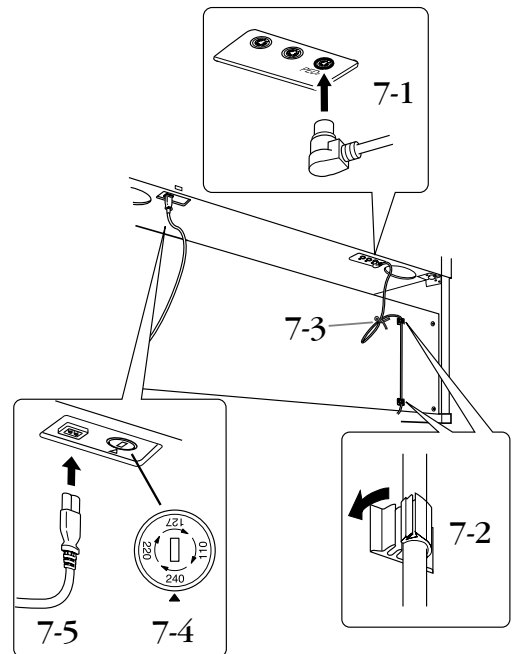

■ Connecting the pedal cord

Insert the pedal cord securely until the metal part of the cord plug disappears from view. Otherwise, the pedal may not function properly.

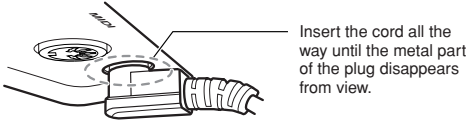

8. Set the adjuster.

Rotate the adjuster until it comes in firm contact with the floor surface.

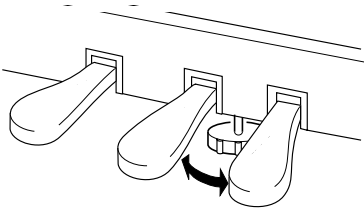

9. Attach the headphone hanger.

Install the headphone hanger using included two screws (4 x 10mm) as shown in the figure.

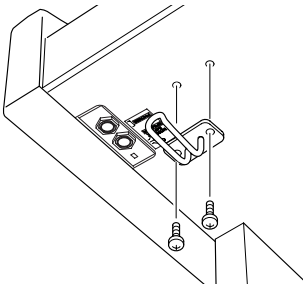

After completing the assembly, please check the following.

- **Are there any parts left over?**
Review the assembly procedure and correct any errors.
- **Is this instrument clear of doors and other movable fixtures?**
Move the instrument to an appropriate location.
- **Does this instrument make a rattling noise when you shake it?**
Tighten all screws.
- **Does the pedal box rattle or give way when you step on the pedals?**
Turn the adjuster so that it is set firmly against the floor.
- **Are the pedal and power cords inserted securely into the sockets?**
Check the connection.
- **If the main unit creaks or is otherwise unsteady when you play on the keyboard, refer to the assembly diagrams and retighten all screws.**

⚠ CAUTION

When moving the instrument after assembly, always hold the bottom of the main unit.

Do not hold the key cover or top portion. Improper handling can result in damage to the instrument or personal injury.

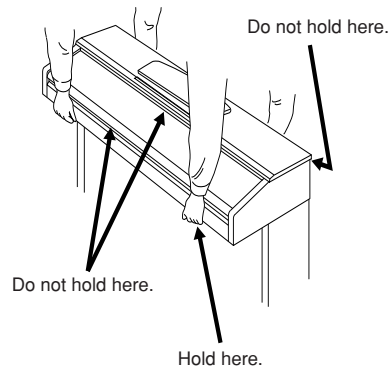

Index

Numerics

- 50 greats for the Piano16
 50 Piano Preset Songs.....16

A

- A-B Repeat18
 Adjust
 Tempo (50 Piano Preset Songs)16
 Tempo (Recorded Songs)41
 Volume (50 Piano Preset Songs)16
 Volume (Metronome)47
 ALL (LED display)16, 42
 Assembly58

B

- Backup (Data).....54
 Backup Functions50
 [BRILLIANCE] button.....21

C

- Character Code50
 Combining Two Voices (Dual mode)25
 Connecting a Personal Computer.....52, 53
 Connections51
 Computer.....52, 53
 Connectors.....51

D

- Damper Pedal20
 [DAMPER RES.] button22
 Damper Resonance.....22
 Delete (USB).....37
 Delete (User song).....31
 [DEMO] button.....15
 Demo Song List.....57
 Demonstration Tunes15
 Display13
 Dual mode25, 46

E

- [EFFECT] button.....21, 22
 Equal Temperament.....45
 Export.....33

F

- Factory Setting.....65
 Factory Setting List.....65
 [FILE] button34
 Fine Tuning of the Pitch45
 Format37, 38
 Function.....45
 Basic Procedure44
 Parameter List43

H

- Half-pedal20
 Hz (Hertz)45

J

- jack60

K

- Key Cover12
 Keyboard Stand58
 Kirnberger.....45

L

- [LEFT] button17, 30
 Left Pedal20
 Left Pedal Mode.....47
 List
 Demo Song57
 Factory Setting.....65
 Functions43
 Message List55
 Preset Voice57
 Load33, 35, 42

M

- [MASTER VOLUME] slider14
 Mean Tone.....45
 Message List.....55
 Metronome.....26
 METRONOME [ON/OFF] button47, 26
 Metronome Volume.....47
 MIDI51
 MIDI Functions.....48
 MIDI [IN] [OUT] terminals.....51
 Music Rest12
 Musicsoft Downloader.....54

N

Normal setting21

P

Part Cancel.....17
 Part Playback On and Off.....42
60
 Pedal Play/Pause42
 Pedals20
 [PHONES] jacks.....14
 [PLAY/PAUSE] button.....15, 16
 Play/Pause playback
 Useful Playback Functions.....42
 Playing Back Songs40, 41
 [POWER] switch13
 Practicing a One-Hand Part Using the 50 Preset Songs.17
 Preset Song.....16
 Preset Voice List.....57
 Pure Major45
 Pure Minor.....45
 Pythagorean45

R

[REC] button28
 Recording.....27
 Initial Settings.....32
 RIGHT/LEFT parts.....30
 Re-recording.....29, 31
 [REVERB] button.....21
 [RIGHT] button17, 30
 Right Pedal.....20
 rnd (LED display)16, 42

S

Save.....33, 34
 Scale.....45
 SMF (Standard MIDI File)33
 Soft Pedal20, 47
 Soft Pedal Effect Depth.....47
 Song.....16
 SONG [PLAY/PAUSE] button.....15, 16, 41
 [SONG SELECT] button.....16, 41
 SONG [STOP] button.....16, 41
 [SPEAKER] switch.....14
 Specifications64
 Sync (Synchronized).....42
 Sync Start17

T

[TEMPO/FUNCTION] button26
 [TOUCH] button.....23
 Touch Sensitivity.....23
 Transporting.....7
 [TRANSPOSE] button.....24
 Transposition24
 Troubleshooting.....56

U

USB Storage Device.....37
 USB [TO DEVICE] terminal51

V

Voice19
 Voice group buttons.....19

W

Werckmeister.....45

Specifications / Caractéristiques techniques / Especificaciones

		YDP-181	
Size /Weight	Width	1364 mm (53-11/16")	
	Height [with music rest]	853 mm (33-9/16") [1002 mm (39-7/16")]	
	Depth	515mm (20-1/4")	
	Weight	50 kg (110lbs., 4 oz.)	
Control Interface	Number of Keys	88	
	Keyboard Type	GH (Graded Hammer) keyboard	
	Touch Sensitivity	Yes	
	Number of Pedal	3	
	Half Pedal	Yes	
	Pedal Functions	Damper (with half-pedal effect), Sostenuto, Soft	
Cabinet	Display	7-Segment LED	
	Key Cover Style	Sliding	
Voices	Music Rest	Yes	
	Tone Generation Technology	AWM Dynamic Stereo Sampling	
Voices	Number of Polyphony (Max.)	128	
	Number of Voices	14	
	Effect	4 types	
Effect	Reverb	4 types	
	Dual	Yes	
Songs	Number of Preset Songs	14 Demo Songs, 50 Piano Preset Songs	
	Recording	Number of Songs	3
		Number of Tracks	2
		Data Capacity	User songs (100KB x 3), External songs (639KB)
	Compatible Data Format	Playback	SMF (Format 0 & 1)
		Recording	SMF (Format 0)
Functions	Metronome	Yes	
	Tempo Range	32–280	
	Transpose	-12 to 0, 0 to +12	
	Tuning	Yes	
	Scale Type	7 types	
Storage	Internal Memory	User songs 300KB, External songs 639KB	
	External Drives	Optional	
Connectivity	Headphones	2	
	MIDI	[IN][OUT]	
	USB [TO DEVICE]	1	
Amplifiers/ Speakers	Amplifiers	20W x 2	
	Speakers	16cm x 2	
Accessories	Owner's Manual, "50 greats for the Piano" Score Collection, My Yamaha Product User Registration, Bench (included or optional depending on locale)		

- * Specifications and descriptions in this owner's manual are for information purposes only. Yamaha Corp. reserves the right to change or modify products or specifications at any time without prior notice. Since specifications, equipment or options may not be the same in every locale, please check with your Yamaha dealer.
- * Les caractéristiques techniques et les descriptions du mode d'emploi ne sont données que pour information. Yamaha Corp. se réserve le droit de changer ou modifier les produits et leurs caractéristiques techniques à tout moment sans aucun avis. Du fait que les caractéristiques techniques, les équipements et les options peuvent différer d'un pays à l'autre, adressez-vous au distributeur Yamaha le plus proche.
- * Las especificaciones y descripciones de este manual del propietario tienen sólo el propósito de servir como información. Yamaha Corp. se reserva el derecho a efectuar cambios o modificaciones en los productos o especificaciones en cualquier momento sin previo aviso. Puesto que las especificaciones, equipos u opciones pueden no ser las mismas en todos los mercados, solicite información a su distribuidor Yamaha.

Factory Setting List / Liste des réglages / Lista de ajustes de fábrica

	Default	Backup Group
Voice	GRAND PIANO 1	F7.1
Dual Mode	OFF	F7.1
Brilliance	NORMAL	F7.4
Reverb Type	Preset for each voice	F7.1
Reverb Depth	Preset for each voice	
Effect Type	Preset for each voice	
Effect Depth	Preset for each voice	
Touch Sensitivity	MEDIUM	
Volume in the FIXED Mode	64	
DAMPER RES.	ON	—
DAMPER RES. Depth	5	—
Metronome	OFF	—
Metronome Time Signature	0 (no accent)	—
Tempo	120	—
Transpose	0	F7.3

Important Notice: Guarantee Information for customers in European Economic Area (EEA) and Switzerland

<p>Important Notice: Guarantee Information for customers in EEA* and Switzerland</p> <p>For detailed guarantee information about this Yamaha product, and Pan-EEA* and Switzerland warranty service, please either visit the website address below (Printable file is available at our website) or contact the Yamaha representative office for your country (next page). * EEA: European Economic Area</p>	English
<p>Wichtiger Hinweis: Garantie-Information für Kunden in der EWR* und der Schweiz</p> <p>Für nähere Garantie-Information über dieses Produkt von Yamaha, sowie über den Pan-EWR*- und Schweizer Garantieservice, besuchen Sie bitte entweder die folgend angegebene Internetadresse (eine druckfähige Version befindet sich auch auf unserer Webseite), oder wenden Sie sich an den für Ihr Land zuständigen Yamaha-Vertrieb (nächste Seite). *EWR: Europäischer Wirtschaftsraum</p>	Deutsch
<p>Remarque importante: informations de garantie pour les clients de l'EEE et la Suisse</p> <p>Pour des informations plus détaillées sur la garantie de ce produit Yamaha et sur le service de garantie applicable dans l'ensemble de l'EEE ainsi qu'en Suisse, consultez notre site Web à l'adresse ci-dessous (le fichier imprimable est disponible sur notre site Web) ou contactez directement Yamaha dans votre pays de résidence (page suivante). * EEE : Espace Economique Européen</p>	Français
<p>Belangrijke mededeling: Garantie-informatie voor klanten in de EER* en Zwitserland</p> <p>Voor gedetailleerde garantie-informatie over dit Yamaha-product en de garantieservice in heel de EER* en Zwitserland, gaat u naar de onderstaande website (u vind een afdrukbaar bestand op onze website) of neemt u contact op met de vertegenwoordiging van Yamaha in uw land (volgende pagina). * EER: Europese Economische Ruimte</p>	Nederlands
<p>Aviso importante: información sobre la garantía para los clientes del EEE* y Suiza</p> <p>Para una información detallada sobre este producto Yamaha y sobre el soporte de garantía en la zona EEE* y Suiza, visite la dirección web que se incluye más abajo (la versión del archivo para imprimir esta disponible en nuestro sitio web) o póngase en contacto con el representante de Yamaha en su país (página siguiente). * EEE: Espacio Económico Europeo</p>	Español
<p>Avviso importante: informazioni sulla garanzia per i clienti residenti nell'EEA* e in Svizzera</p> <p>Per informazioni dettagliate sulla garanzia relativa a questo prodotto Yamaha e l'assistenza in garanzia nei paesi EEA* e in Svizzera, potete consultare il sito Web all'indirizzo riportato di seguito (è disponibile il file in formato stampabile) oppure contattare l'ufficio di rappresentanza locale della Yamaha (pagina seguente). * EEA: Area Economica Europea</p>	Italiano
<p>Aviso importante: informações sobre as garantias para clientes da AEE* e da Suíça</p> <p>Para obter uma informação pormenorizada sobre este produto da Yamaha e sobre o serviço de garantia na AEE* e na Suíça, visite o site a seguir (o arquivo para impressão está disponível no nosso site) ou entre em contato com o escritório de representação da Yamaha no seu país (próxima página). * AEE: Área Económica Européia</p>	Português
<p>Σημαντική σημείωση: Πληροφορίες εγγύησης για τους πελάτες στον EOX* και Ελλάδα</p> <p>Για λεπτομερείς πληροφορίες εγγύησης σχετικά με το παρόν προϊόν της Yamaha και την κάλυψη εγγύησης σε όλες τις χώρες του EOX και την Ελλάδα, επισκεφτείτε την παρακάτω ιστοσελίδα (Εκτυπίσιμη μορφή είναι διαθέσιμη στην ιστοσελίδα μας) ή απευθυνθείτε στην αντιπροσωπεία της Yamaha στη χώρα σας (επόμενη σελίδα). * EOX: Ευρωπαϊκός Οικονομικός Χώρος</p>	Ελληνικά
<p>Viktigt: Garantiinformation för kunder i EES-området* och Schweiz</p> <p>För detaljerad information om denna Yamahaprodukt samt garantiservice i hela EES-området* och Schweiz kan du antingen besöka nedanstående webbadress (en utskriftsvänlig fil finns på webbplatsen) eller kontakta Yamahas officiella representant i ditt land (nästa sida). * EES: Europeiska Ekonomiska Samarbetsområdet</p>	Svenska
<p>Viktig merknad: Garantiinformasjon for kunder i EØS* og Sveits</p> <p>Detaljert garantiinformasjon om dette Yamaha-produktet og garantiservice for hele EØS-området* og Sveits kan fås enten ved å besøke nettstedene nedenfor (utskriftsversjon finnes på våre nettsider) eller kontakte Yamahas kontoret i landet der du bor (neste side). *EØS: Det europeiske økonomiske samarbeidsområdet</p>	Norsk
<p>Vigtig oplysning: Garantioplysninger til kunder i EØ* og Schweiz</p> <p>De kan finde detaljerede garantioplysninger om dette Yamaha-produkt og den fælles garantiserviceordning for EØ* (og Schweiz) ved at besøge det websted, der er angivet nedenfor (der findes en fil, som kan udskrives, på vores websted), eller ved at kontakte Yamahas nationale repræsentationskontor i det land, hvor De bor (næste side). * EØ: Det Europæiske Økonomiske Område</p>	Dansk
<p>Tärkeä ilmoitus: Takuutiedot Euroopan talousalueen (ETA)* ja Sveitsin asiakkaille</p> <p>Tämän Yamaha-tuotteen sekä ETA-alueen ja Sveitsin takuuta koskevat yksityiskohtaiset tiedot saatte alla olevasta nettiosoitteesta. (Tulostettava tiedosto saatavissa sivustollamme.) Voitte myös ottaa yhteyttä paikalliseen Yamaha-edustajaan (seuraavalla sivulla). *ETA: Euroopan talousalue</p>	Suomi
<p>Ważne: Warunki gwarancyjne obowiązujące w EOG* i Szwajcarii</p> <p>Abi dowiedzieć się więcej na temat warunków gwarancyjnych tego produktu firmy Yamaha i serwisu gwarancyjnego w całym EOG* i Szwajcarii, należy odwiedzić wskazaną poniżej stronę internetową (Plik gotowy do wydruku znajduje się na naszej stronie internetowej) lub skontaktować się z przedstawicielstwem firmy Yamaha w swoim kraju (następna strona). * EOG — Europejski Obszar Gospodarczy</p>	Polski
<p>Důležité oznámení: Zárucní informace pro zákazníky v EHS* a ve Švýcarsku</p> <p>Podrobné záruční informace o tomto produktu Yamaha a záručním servisu v celém EHS* a ve Švýcarsku naleznete na níže uvedené webové adrese (soubor k tisku je dostupný na našich webových stránkách) nebo se můžete obrátit na zastoupení firmy Yamaha ve své zemi (další stránka). * EHS: Evropský hospodářský prostor</p>	Česky
<p>Fontos figyelemzetés: Garancia-információk az EGT* területén és Svájcban élő vásárlók számára</p> <p>A jelen Yamaha termékre vonatkozó részletes garancia-információk, valamint az EGT*-re és Svájcra kiterjedő garanciális szolgáltatás tekintetében keresse fel webhelyünket az alábbi címen (a webhelyen nyomtatható fájl is talál), vagy pedig lépjen kapcsolatba az országában működő Yamaha képviseleti irodával (következő oldal). * EGT: Európai Gazdasági Térség</p>	Magyar
<p>Oluline märkus: Garantiteave Euroopa Majanduspiirkonna (EMP)* ja Šveitsi klientidele</p> <p>Täpsemate teabe saamiseks selle Yamaha toote garantii ning kogu Euroopa Majanduspiirkonna ja Šveitsi garantiteeninduse kohta, külastage palun veebisaiti alljärgneval aadressil (meie saidil on saadaval printitav fail) või pöörduge Teie regiooni Yamaha esinduse poole (järgmine lehekülg). * EMP: Euroopa Majanduspiirkond</p>	Eesti keel
<p>Svarīgs paziņojums: garantijas informācija klientiem EEZ* un Šveicē</p> <p>Lai saņemtu detalizētu garantijas informāciju par šo Yamaha produktu, kā arī garantijas apkalpošanu EEZ* un Šveicē, lūdzu, apmeklējiet zemāk norādīto tīmekļa vietnes adresi (tīmekļa vietnē ir pieejams drukājams fails) vai sazinieties ar jūsu valsti apkalpojošo Yamaha pārstāvniecību (nākamā lappuse). * EEZ: Eiropas Ekonomikas zona</p>	Latviešu
<p>Dėmesio: informacija dėl garantijos pirkėjams EEE* ir Šveicarijoje</p> <p>Jei reikia išsamios informacijos apie šį „Yamaha“ produktą ir jo techninę priežiūrą visoje EEE* ir Šveicarijoje, apsilankykite mūsų svetainėje toliau nurodytu adresu (svetainėje yra spausdintinas failas) arba kreipkitės į „Yamaha“ atstovybę savo šaliai (kitas puslapis). *EEE – Europos ekonominė erdvė</p>	Lietuvių kalba
<p>Dôležité upozornenie: Informácie o záruke pre zákazníkov v EHP* a Švajčiarsku</p> <p>Podrobné informácie o záruke týkajúce sa tohto produktu od spoločnosti Yamaha a garančnom servise v EHP* a Švajčiarsku nájdete na webovej stránke uvedenej nižšie (na našej webovej stránke je k dispozícii súbor na tlač) alebo sa obráťte na zástupcu spoločnosti Yamaha vo svojej krajine (nasledujúca strana). * EHP: Európsky hospodársky priestor</p>	Slovenčina
<p>Pomembno obvestilo: Informacije o garanciji za kupce v EGP* in Švici</p> <p>Za podrobnejše informacije o tem Yamahinem izdelku ter garancijskem servisu v celotnem EGP in Švici, obiščite spletno mesto, ki je navedeno spodaj (natisljiva datoteka je na voljo na našem spletnem mestu), ali se obrnite na Yamahinega predstavnika v svoji državi (naslednja stran). * EGP: Evropski gospodarski prostor</p>	Slovenščina
<p>Важно съобщение: Информация за гаранцията за клиенти в ЕИП* и Швейцария</p> <p>За подробна информация за гаранцията за този продукт на Yamaha и гаранционното обслужване в паневропейската зона на ЕИП* и Швейцария или посетете посочения по-долу уеб сайт (на нашия уеб сайт има файл за печат), или се свържете с представителния офис на Yamaha във вашата страна (следваща страница). * ЕИП: Европейско икономическо пространство</p>	Български език
<p>Notificarea importantă: Informații despre garanție pentru clienții din SEE* și Elveția</p> <p>Pentru informații detaliate privind acest produs Yamaha și serviciul de garanție Pan-SEE* și Elveția, vizitați site-ul la adresa de mai jos (fișierul imprimabil este disponibil pe site-ul nostru) sau contactați biroul reprezentanței Yamaha din țara dumneavoastră (pagina următoare). * SEE: Spațiul Economic European</p>	Limba română

<http://europe.yamaha.com/warranty/>

Yamaha Representative Offices in Europe

AUSTRIA

Yamaha Music Europe GmbH
Branch Austria
Schleiergasse 20, A-1100 Wien Austria
Tel: +43 (0)1 602 03900
Fax: +43 (0)1 602 039051

BELGIUM

Yamaha Music Europe
Branch Benelux
Clarissenhof 5b NL, 4133 AB. Vianen
The Netherlands
Tel: +31 (0)347 358040
Fax: +31 (0)347 358060

BULGARIA

Yamaha Music Europe GmbH
Branch Austria (Central and Eastern Europe)
Schleiergasse 20, A-1100 Wien Austria
Tel: +43 (0)1 602 03900
Fax: +43 (0)1 602 039051

CYPRUS

NAKAS Music Cyprus Ltd.
31C Nikis Ave., 1086 Nicosia
Tel: +357 (0)22 510 477
Fax: +357 (0)22 511 080

CZECH REPUBLIC

Yamaha Music Europe GmbH
Branch Austria (Central and Eastern Europe)
Schleiergasse 20, A-1100 Wien Austria
Tel: +43 (0)1 602 03900
Fax: +43 (0)1 602 039051

DENMARK

YS Copenhagen Liaison Office
(Yamaha Scandinavia AB Filial Denmark)
Generatorvej 6A, 2730 Herlev, Denmark
Tel: +45 44 92 49 00
Fax: +45 44 54 47 09

ESTONIA

Yamaha Music Europe GmbH
Sp. z o.o. Oddział w Polsce
(Branch Poland)
ul. 17 Stycznia 56
PL-02-146 Warszawa Poland
Tel: +48 (0)22 500 29 25
Fax: +48 (0)22 500 29 30

FINLAND

(For Musical Instrument)
F - Musiikki OY
Kaisaniemenkatu 7, PL260
00101 Helsinki, Finland
Tel: +358 (0)9 618511
Fax: +358 (0)9 61851385

(For Pro Audio)

Yamaha Scandinavia AB
J A Wettergrens gata 1
Västra Frölunda, Sweden
(Box 300 53, 400 43 Goteborg
Sweden - Postal Address)
Tel: +46 (0)31 893400
Fax: +46 (0)31 454026

FRANCE

Yamaha Musique France
Zone d'activité de Pariest
7, rue Ambroise Croizat
77183 Croissy-Beaubourg, France
(B.P. 70, 77312 Marne la Vallée Cedex 2
France-Adresse postale)
Tel: +33 (0)1 64 61 4000
Fax: +33 (0)1 64 61 4079

GERMANY

Yamaha Music Europe GmbH
Siemensstr 22-34
D-25462 Rellingen, b. Hamburg, Germany
Tel: +49 (0)4101 3030
Fax: +49 (0)4101 303 77702

GREECE

PH. Nakas S.A.Music House/Service
19 KM Leoforos Lavriou
19002 Peania / Attiki, Greece
Tel: +30 (0)210 6686260
Fax: +30 (0)210 6686269

HUNGARY

Yamaha Music Europe GmbH
Branch Austria (Central and Eastern Europe)
Schleiergasse 20, A-1100 Wien Austria
Tel: +43 (0)1 602 03900
Fax: +43 (0)1 602 039051

ICELAND

(For Musical Instrument)
HLJODFAERAHUSID EHF
Sidumula 20
108 Reykjavik, Iceland
Tel: +354 525 50 50
Fax: +354 568 65 14

(For Pro Audio)

Yamaha Scandinavia AB
J A Wettergrens gata 1
Västra Frölunda, Sweden
(Box 300 53, 400 43 Goteborg
Sweden - Postal Address)
Tel: +46 (0)31 893400
Fax: +46 (0)31 454026

IRELAND (REPUBLIC OF IRELAND)

Yamaha Music UK Ltd.
Sherbourne Drive
Tilbrook, Milton Keynes MK7 8BL
United Kingdom
Tel: +353 (0) 1526 2449
Fax: +44 (0) 1908 369278

ITALY

Yamaha Musica Italia s.p.a.
Viale Italia 88
20020, Lainate (Milano), Italy
Tel: +39 (0)02 93577 1
Fax: +39 (0)02 937 0956

LATVIA

Yamaha Music Europe GmbH
Sp. z o.o. Oddział w Polsce
(Branch Poland)
ul. 17 Stycznia 56
PL-02-146 Warszawa Poland
Tel: +48 (0)22 500 29 25
Fax: +48 (0)22 500 29 30

LIECHTENSTEIN

Yamaha Music Europe GmbH, Rellingen,
Branch Switzerland in Zurich
Seefeldstrasse 94, CH-8008
Zürich, Switzerland
Tel: +41 (0)44 3878080
Fax: +41 (0)44 3833918

LITHUANIA

Yamaha Music Europe GmbH
Sp. z o.o. Oddział w Polsce
(Branch Poland)
ul. 17 Stycznia 56
PL-02-146 Warszawa Poland
Tel: +48 (0)22 500 29 25
Fax: +48 (0)22 500 29 30

LUXEMBOURG

Yamaha Music Europe
Branch Benelux
Clarissenhof 5b NL, 4133 AB. Vianen
The Netherlands
Tel: +31 (0)347 358040
Fax: +31 (0)347 358060

MALTA

Olimpus Music Ltd.
The Emporium, Level 3, St. Louis Street
Msida MSD06
Tel: +356 (0)2133 2093
Fax: +356 (0)2133 2144

NETHERLANDS

Yamaha Music Europe
Branch Benelux
Clarissenhof 5b NL, 4133 AB. Vianen
The Netherlands
Tel: +31 (0)347 358040
Fax: +31 (0)347 358060

NORWAY

YS Oslo Liaison Office
(Yamaha Scandinavia AB Filial Norway)
Grini Naeringspark 1
1361 Osteras, Norway
Tel: +47 67 16 77 70
Fax: +47 67 16 77 79

POLAND

YAMAHA Music Europe GmbH
Sp. z o.o. Oddział w Polsce
ul. 17 Stycznia 56
02-146 WARSZAWA/POLSKA
Tel: +48 (0)22 500 29 25
Fax: +48 (0)22 500 29 30

PORTUGAL

Yamaha Música Ibérica, S.A.U.
Sucursal Portuguesa
Rua Alfredo da Silva
2610-016 Amadora, Portugal
Tel: +351 214 704 330
Fax: +351 214 718 220

ROMANIA

Yamaha Music Europe GmbH
Branch Austria (Central and Eastern
Europe)
Schleiergasse 20, A-1100 Wien Austria
Tel: +43 (0)1 602 03900
Fax: +43 (0)1 602 039051

SLOVAKIA

Yamaha Music Europe GmbH
Branch Austria (Central and Eastern
Europe)
Schleiergasse 20, A-1100 Wien Austria
Tel: +43 (0)1 602 03900
Fax: +43 (0)1 602 039051

SLOVENIA

Yamaha Music Europe GmbH
Branch Austria (Central and Eastern
Europe)
Schleiergasse 20, A-1100 Wien Austria
Tel: +43 (0)1 602 03900
Fax: +43 (0)1 602 039051

SPAIN

Yamaha Música Ibérica, S.A.U.
Ctra. de la Corona km.17, 200
28230 Las Rozas de Madrid, Spain
Tel: +34 902 39 8888
Fax: +34 91 638 4660

SWEDEN

Yamaha Scandinavia AB
J A Wettergrens gata 1
Västra Frölunda, Sweden
(Box 300 53, 400 43 Goteborg
Sweden - Postal Address)
Tel: +46 (0)31 893400
Fax: +46 (0)31 454026

SWITZERLAND

Yamaha Music Europe GmbH, Rellingen,
Branch Switzerland in Zurich
Seefeldstrasse 94, CH-8008
Zürich, Switzerland
Tel: +41 (0)44 3878080
Fax: +41 (0)44 3833918

UNITED KINGDOM

Yamaha Music UK Ltd.
Sherbourne Drive
Tilbrook, Milton Keynes MK7 8BL
United Kingdom
Tel: +44 (0) 870 4445575
Fax: +44 (0) 1908 369278

FCC INFORMATION (U.S.A.)

1. IMPORTANT NOTICE: DO NOT MODIFY THIS UNIT!

This product, when installed as indicated in the instructions contained in this manual, meets FCC requirements. Modifications not expressly approved by Yamaha may void your authority, granted by the FCC, to use the product.

2. IMPORTANT:

When connecting this product to accessories and/or another product use only high quality shielded cables. Cable/s supplied with this product MUST be used. Follow all installation instructions. Failure to follow instructions could void your FCC authorization to use this product in the USA.

3. NOTE:

This product has been tested and found to comply with the requirements listed in FCC Regulations, Part 15 for Class "B" digital devices. Compliance with these requirements provides a reasonable level of assurance that your use of this product in a residential environment will not result in harmful interference with other electronic devices. This equipment generates/uses radio frequencies and, if not installed and used according to the instructions found in the users manual, may cause interference harmful to the operation of

other electronic devices. Compliance with FCC regulations does not guarantee that interference will not occur in all installations. If this product is found to be the source of interference, which can be determined by turning the unit "OFF" and "ON," please try to eliminate the problem by using one of the following measures:

Relocate either this product or the device that is being affected by the interference.

Utilize power outlets that are on different branch (circuit breaker or fuse) circuits or install AC line filter/s.

In the case of radio or TV interference, relocate/reorient the antenna. If the antenna lead-in is 300 ohm ribbon lead, change the lead-in to co-axial type cable.

If these corrective measures do not produce satisfactory results, please contact the local retailer authorized to distribute this type of product. If you can not locate the appropriate retailer, please contact Yamaha Corporation of America, Electronic Service Division, 6600 Orangethorpe Ave, Buena Park, CA90620

The above statements apply ONLY to those products distributed by Yamaha Corporation of America or its subsidiaries.

* This applies only to products distributed by YAMAHA CORPORATION OF AMERICA.

(class B)

IMPORTANT NOTICE FOR THE UNITED KINGDOM

Connecting the Plug and Cord

IMPORTANT. The wires in this mains lead are coloured in accordance with the following code:

BLUE : NEUTRAL

BROWN : LIVE

As the colours of the wires in the mains lead of this apparatus may not correspond with the coloured markings identifying the terminals in your plug proceed as follows: The wire which is coloured BLUE must be connected to the terminal which is marked with the letter N or coloured BLACK.

The wire which is coloured BROWN must be connected to the terminal which is marked with the letter L or coloured RED.

Making sure that neither core is connected to the earth terminal of the three pin plug.

• This applies only to products distributed by Yamaha Music U.K. Ltd.

(2 wires)



Information for Users on Collection and Disposal of Old Equipment

This symbol on the products, packaging, and/or accompanying documents means that used electrical and electronic products should not be mixed with general household waste. For proper treatment, recovery and recycling of old products, please take them to applicable collection points, in accordance with your national legislation and the Directives 2002/96/EC.

By disposing of these products correctly, you will help to save valuable resources and prevent any potential negative effects on human health and the environment which could otherwise arise from inappropriate waste handling.

For more information about collection and recycling of old products, please contact your local municipality, your waste disposal service or the point of sale where you purchased the items.

[For business users in the European Union]

If you wish to discard electrical and electronic equipment, please contact your dealer or supplier for further information.

[Information on Disposal in other Countries outside the European Union]

This symbol is only valid in the European Union. If you wish to discard these items, please contact your local authorities or dealer and ask for the correct method of disposal.

(weee_eu)



Information concernant la Collecte et le Traitement des déchets d'équipements électriques et électroniques.

Le symbole sur les produits, l'emballage et/ou les documents joints signifie que les produits électriques ou électroniques usagés ne doivent pas être mélangés avec les déchets domestiques habituels. Pour un traitement, une récupération et un recyclage appropriés des déchets d'équipements électriques et électroniques, veuillez les déposer aux points de collecte prévus à cet effet, conformément à la réglementation nationale et aux Directives 2002/96/EC.

En vous débarrassant correctement des déchets d'équipements électriques et électroniques, vous contribuerez à la sauvegarde de précieuses ressources et à la prévention de potentiels effets négatifs sur la santé humaine qui pourraient advenir lors d'un traitement inapproprié des déchets.

Pour plus d'informations à propos de la collecte et du recyclage des déchets d'équipements électriques et électroniques, veuillez contacter votre municipalité, votre service de traitement des déchets ou le point de vente où vous avez acheté les produits.

[Pour les professionnels dans l'Union Européenne]

Si vous souhaitez vous débarrasser des déchets d'équipements électriques et électroniques veuillez contacter votre vendeur ou fournisseur pour plus d'informations.

[Information sur le traitement dans d'autres pays en dehors de l'Union Européenne]

Ce symbole est seulement valable dans l'Union Européenne. Si vous souhaitez vous débarrasser de déchets d'équipements électriques et électroniques, veuillez contacter les autorités locales ou votre fournisseur et demander la méthode de traitement appropriée.

(weee_eu)



Información para Usuarios sobre Recolección y Disposición de Equipamiento Viejo

Este símbolo en los productos, embalaje, y/o documentación que se acompañe significa que los productos electrónicos y eléctricos usados no deben ser mezclados con desechos hogareños corrientes. Para el tratamiento, recuperación y reciclado apropiado de los productos viejos, por favor llévelos a puntos de recolección aplicables, de acuerdo a su legislación nacional y las directivas 2002/96/EC.

Al disponer de estos productos correctamente, ayudará a ahorrar recursos valiosos y a prevenir cualquier potencial efecto negativo sobre la salud humana y el medio ambiente, el cual podría surgir de un inapropiado manejo de los desechos.

Para mayor información sobre recolección y reciclado de productos viejos, por favor contacte a su municipio local, su servicio de gestión de residuos o el punto de venta en el cual usted adquirió los artículos.

[Para usuarios de negocios en la Unión Europea]

Si usted desea deshacerse de equipamiento eléctrico y electrónico, por favor contacte a su vendedor o proveedor para mayor información.

[Información sobre la Disposición en otros países fuera de la Unión Europea]

Este símbolo sólo es válidos en la Unión Europea. Si desea deshacerse de estos artículos, por favor contacte a sus autoridades locales y pregunte por el método correcto de disposición.

(weee_eu)

For details of products, please contact your nearest Yamaha representative or the authorized distributor listed below.

Para detalles sobre productos, contacte su tienda Yamaha más cercana o el distribuidor autorizado que se lista debajo.

Pour plus de détails sur les produits, veuillez-vous adresser à Yamaha ou au distributeur le plus proche de vous figurant dans la liste suivante.

NORTH AMERICA

CANADA

Yamaha Canada Music Ltd.
135 Milner Avenue, Scarborough, Ontario,
M1S 3R1, Canada
Tel: 416-298-1311

U.S.A.

Yamaha Corporation of America
6600 Orangethorpe Ave., Buena Park, Calif. 90620,
U.S.A.
Tel: 714-522-9011

CENTRAL & SOUTH AMERICA

MEXICO

Yamaha de México S.A. de C.V.
Calz. Javier Rojo Gómez #1149,
Col. Guadalupe del Moral
C.P. 09300, México, D.F., México
Tel: 55-5804-0600

BRAZIL

Yamaha Musical do Brasil Ltda.
Rua Joaquim Floriano, 913 - 4º andar, Itaim Bibi, CEP
04534-013 Sao Paulo, SP, BRAZIL
Tel: 011-3704-1377

ARGENTINA

Yamaha Music Latin America, S.A.
Sucursal de Argentina
Olga Cossetтини 1553, Piso 4 Norte
Madero Este-C1107CEK
Buenos Aires, Argentina
Tel: 011-4119-7000

PANAMA AND OTHER LATIN AMERICAN COUNTRIES/ CARIBBEAN COUNTRIES

Yamaha Music Latin America, S.A.
Torre Banco General, Piso 7, Urbanización Marbella,
Calle 47 y Aquilino de la Guardia,
Ciudad de Panamá, Panamá
Tel: +507-269-5311

EUROPE

THE UNITED KINGDOM/IRELAND

Yamaha Music U.K. Ltd.
Sherbourne Drive, Tilbrook, Milton Keynes,
MK7 8BL, England
Tel: 01908-366700

GERMANY

Yamaha Music Europe GmbH
Siemensstraße 22-34, 25462 Rellingen, Germany
Tel: 04101-3030

SWITZERLAND/LIECHTENSTEIN

Yamaha Music Europe GmbH
Branch Switzerland in Zürich
Seefeldstrasse 94, 8008 Zürich, Switzerland
Tel: 01-383 3990

AUSTRIA

Yamaha Music Europe GmbH Branch Austria
Schleiergasse 20, A-1100 Wien, Austria
Tel: 01-60203900

CZECH REPUBLIC/SLOVAKIA/ HUNGARY/SLOVENIA

Yamaha Music Europe GmbH Branch Austria
Schleiergasse 20, A-1100 Wien, Austria
Tel: 01-602039025

POLAND/LITHUANIA/LATVIA/ESTONIA

Yamaha Music Europe GmbH
Branch Sp.z o.o. Oddział w Polsce
ul. 17 Stycznia 36, PL-02-146 Warszawa, Poland
Tel: 022-868-07-57

THE NETHERLANDS/

BELGIUM/LUXEMBOURG

Yamaha Music Europe Branch Benelux
Clarissenhof 5-b, 4133 AB Vianen, The Netherlands
Tel: 0347-358 040

FRANCE

Yamaha Musique France
BP 70-77312 Marne-la-Vallée Cedex 2, France
Tel: 01-64-61-4000

ITALY

Yamaha Musica Italia S.P.A.
Viale Italia 88, 20020 Lainate (Milano), Italy
Tel: 02-935-7711

SPAIN/PORTUGAL

Yamaha Música Ibérica, S.A.
Ctra. de la Coruna km. 17, 200, 28230
Las Rozas (Madrid), Spain
Tel: 91-639-8888

GREECE

Philippos Nakas S.A. The Music House
147 Skiathou Street, 112-55 Athens, Greece
Tel: 01-228 2160

SWEDEN

Yamaha Scandinavia AB
J. A. Wettergrens Gata 1, Box 30053
S-400 43 Göteborg, Sweden
Tel: 031 89 34 00

DENMARK

YS Copenhagen Liaison Office
Generatorvej 6A, DK-2730 Herlev, Denmark
Tel: 44 92 49 00

FINLAND

F-Musiikki Oy
Kluuvikatu 6, P.O. Box 260,
SF-00101 Helsinki, Finland
Tel: 09 618511

NORWAY

Norsk filial av Yamaha Scandinavia AB
Grini Næringspark 1, N-1345 Østerås, Norway
Tel: 67 16 77 70

ICELAND

Skifan HF
Skeifan 17 P.O. Box 8120, IS-128 Reykjavik, Iceland
Tel: 525 5000

RUSSIA

Yamaha Music (Russia)
Office 4015, entrance 2, 21/5 Kuznetskii
Most street, Moscow, 107996, Russia
Tel: 495 626 0660

OTHER EUROPEAN COUNTRIES

Yamaha Music Europe GmbH
Siemensstraße 22-34, 25462 Rellingen, Germany
Tel: +49-4101-3030

AFRICA

Yamaha Corporation,
Asia-Pacific Music Marketing Group
Nakazawa-cho 10-1, Naka-ku, Hamamatsu,
Japan 430-8650
Tel: +81-53-460-2312

MIDDLE EAST

TURKEY/CYPRUS

Yamaha Music Europe GmbH
Siemensstraße 22-34, 25462 Rellingen, Germany
Tel: 04101-3030

OTHER COUNTRIES

Yamaha Music Gulf FZE
LOB 16-513, P.O.Box 17328, Jubel Ali,
Dubai, United Arab Emirates
Tel: +971-4-881-5868

ASIA

THE PEOPLE'S REPUBLIC OF CHINA

Yamaha Music & Electronics (China) Co.,Ltd.
2F, Yunhedasha, 1818 Xinzha-lu, Jingan-qu,
Shanghai, China
Tel: 021-6247-2211

HONG KONG

Tom Lee Music Co., Ltd.
11/F, Silvercord Tower 1, 30 Canton Road,
Tsimshatsui, Kowloon, Hong Kong
Tel: 2737-7688

INDIA

Yamaha Music India Pvt. Ltd.
5F Ambience Corporate Tower Ambience Mall Complex
Ambience Island, NH-8, Gurgaon-122001, Haryana, India
Tel: 0124-466-5551

INDONESIA

PT. Yamaha Music Indonesia (Distributor)
PT. Nusantik

Gedung Yamaha Music Center, Jalan Jend. Gatot Subroto Kav. 4, Jakarta 12930, Indonesia
Tel: 21-520-2577

KOREA

Yamaha Music Korea Ltd.
8F, 9F, Dongsung Bldg. 158-9 Samsung-Dong, Kangnam-Gu, Seoul, Korea
Tel: 080-004-0022

MALAYSIA

Yamaha Music Malaysia, Sdn., Bhd.
Lot 8, Jalan Perbandaran, 47301 Kelana Jaya,
Petaling Jaya, Selangor, Malaysia
Tel: 3-7803090

PHILIPPINES

Yupangco Music Corporation
339 Gil J. Puyat Avenue, P.O. Box 885 MCPO,
Makati, Metro Manila, Philippines
Tel: 819-7551

SINGAPORE

Yamaha Music Asia Pte., Ltd.
#03-11 A-Z Building
140 Paya Lebar Road, Singapore 409015
Tel: 747-4374

TAIWAN

Yamaha KHS Music Co., Ltd.
3F, #6, Sec.2, Nan Jing E. Rd. Taipei,
Taiwan 104, R.O.C.
Tel: 02-2511-8688

THAILAND

Siam Music Yamaha Co., Ltd.
4, 6, 15 and 16th floor, Siam Motors Building,
891/1 Rama 1 Road, Wangmai,
Pathumwan, Bangkok 10330, Thailand
Tel: 02-215-2626

OTHER ASIAN COUNTRIES

Yamaha Corporation,
Asia-Pacific Music Marketing Group
Nakazawa-cho 10-1, Naka-ku, Hamamatsu,
Japan 430-8650
Tel: +81-53-460-2317

OCEANIA

AUSTRALIA

Yamaha Music Australia Pty. Ltd.
Level 1, 99 Queensbridge Street, Southbank,
Victoria 3006, Australia
Tel: 3-9693-5111

NEW ZEALAND

Music Works LTD
P.O. BOX 6246 Wellesley, Auckland 4680,
New Zealand
Tel: 9-634-0099

COUNTRIES AND TRUST TERRITORIES IN PACIFIC OCEAN

Yamaha Corporation,
Asia-Pacific Music Marketing Group
Nakazawa-cho 10-1, Naka-ku, Hamamatsu,
Japan 430-8650
Tel: +81-53-460-2312

HEAD OFFICE Yamaha Corporation, Pro Audio & Digital Musical Instrument Division

Nakazawa-cho 10-1, Naka-ku, Hamamatsu, Japan 430-8650
Tel: +81-53-460-3273

EKB50

Yamaha Global Home
<http://www.yamaha.com/>

Yamaha Manual Library
<http://www.yamaha.co.jp/manual/>

U.R.G., Pro Audio & Digital Musical Instrument Division, Yamaha Corporation

© 2010-2011 Yamaha Corporation

WT54870 109MWAP*. *01A1 Printed in Vietnam